

Photocoupler LTV-155E-L series

1.5 Amp Output Current IGBT Gate Drive Optocoupler with Rail-to-Rail Output Voltage, High CMR.

1. DESCRIPTION

The LTV-155E-L-DI optocoupler is ideally suited for driving power IGBTs and MOSFETs used in motor control inverter applications and inverters in power supply system. It contains an AlGaAs LED optically coupled to an integrated circuit with a power output stage. The 1.5A peak output current is capable of directly driving most IGBTs with ratings up to 1200 V/50 A. For IGBTs with higher ratings, the LTV-155E-L-DI series can be used to drive a discrete power stage which drives the IGBT gate.

The Optocoupler operational parameters are guaranteed over the temperature range from $-40^{\circ}\text{C} \sim +105^{\circ}\text{C}$.

1.1 Features

- 1.5 A maximum peak output current driving capability
- Rail-to-rail output voltage
- 200 ns maximum propagation delay
- 70 ns maximum propagation delay difference
- 35 kV/us minimum Common Mode Rejection (CMR) at $V_{CM} = 1500\text{ V}$
- $I_{CC} = 3.0\text{ mA}$ maximum supply current
- Wide operating range: 10 to 30 Volts (V_{CC})
- Guaranteed performance over temperature $-40^{\circ}\text{C} \sim +105^{\circ}\text{C}$.
- MSL Level 1
- Safety approval:
 - UL/ cUL Recognized 3750 $V_{RMS}/1\text{ min}$
 - IEC/EN/DIN EN 60747-5-5 $V_{IORM} = 565\text{ V}_{peak}$

1.2 Applications

- Plasma Display Panel .
- IGBT/MOSFET gate drive
- Uninterruptible power supply (UPS)
- Industrial Inverter
- Induction heating

Functional Diagram

Pin No. and Internal connection diagram

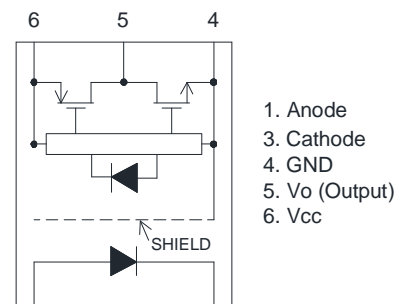

Truth Table¹

| LED | High side | Low side | V_o |
|-----|-----------|----------|-------|
| OFF | OFF | ON | Low |
| ON | ON | OFF | High |

Note: A $0.1\mu\text{F}$ bypass capacitor must be connected between Pin 4 and 6.

**Photocoupler
LTV-155E-L series**

2. PACKAGE DIMENSIONS

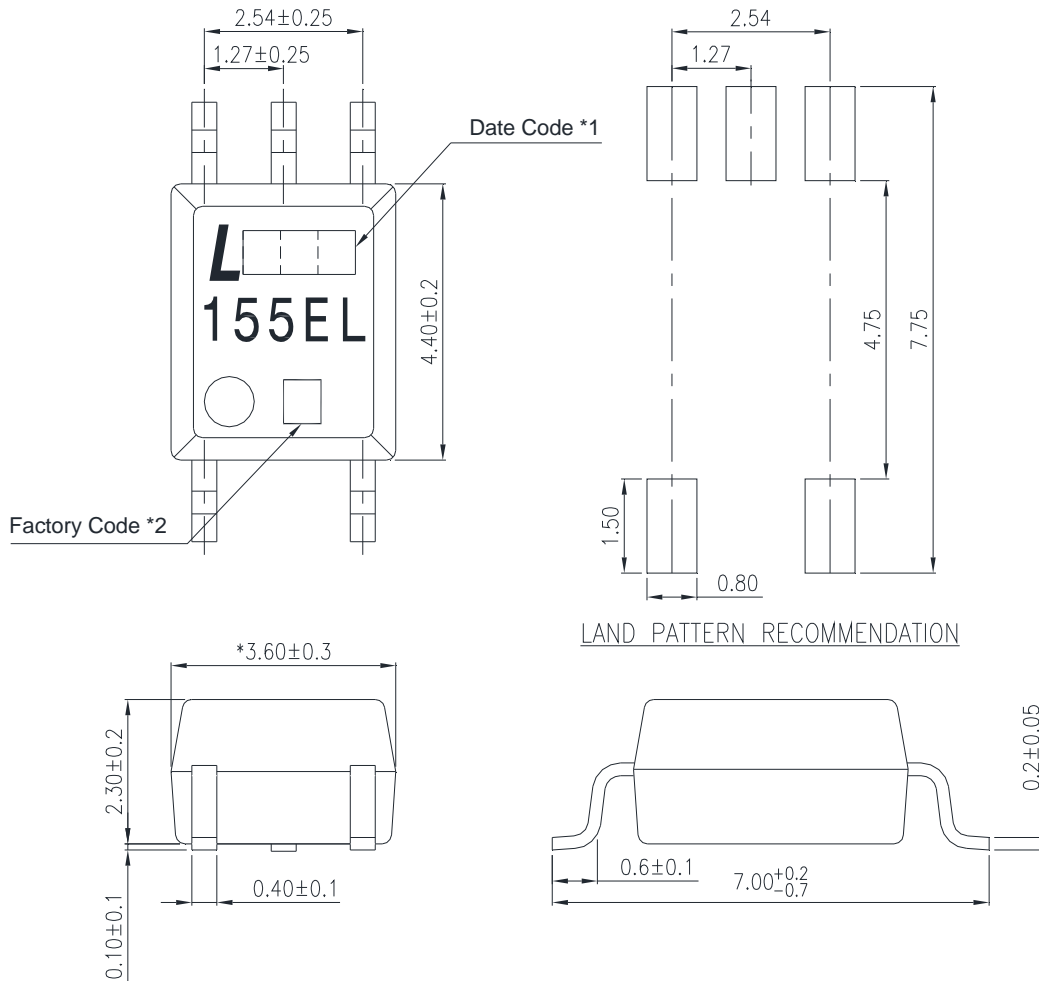

Part No : LTV-155E-L

Notes :

1. The first digit is year date code, second and third digit are work week
 2. Factory identification mark (W :China-CZ)
 3. "4" or "V" for VDE option
- Dimensions are all in Millimeters.

Photocoupler
LTV-155E-L series

3. TAPING DIMENSIONS

3.1 LTV-155E-L

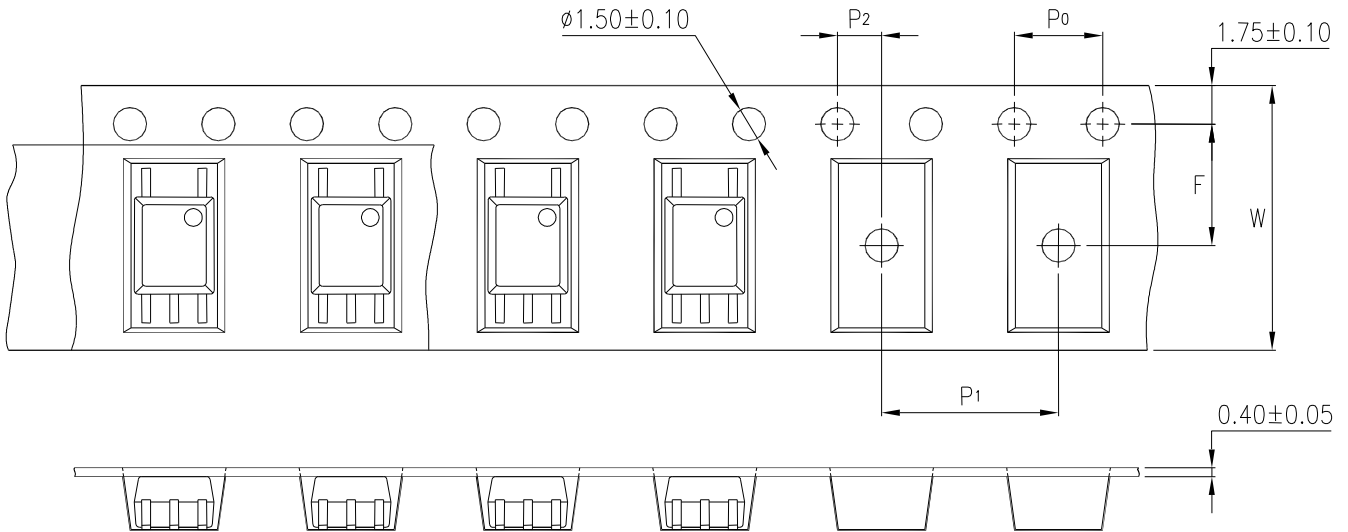

| Description | Symbol | Dimension in mm (inch) |
|----------------------------------------|----------------|------------------------|
| Tape wide | W | 12±0.3 (0.47) |
| Pitch of sprocket holes | P ₀ | 4±0.1 (0.15) |
| Distance of compartment | F | 5.5±0.1 (0.217) |
| | P ₂ | 2±0.1 (0.079) |
| Distance of compartment to compartment | P ₁ | 8±0.1 (0.315) |

3.2 Quantities Per Reel

| Package Type | LTV-155E-L series |
|------------------|-------------------|
| Quantities (pcs) | 3000 |

Photocoupler LTV-155E-L series

4. RATING AND CHARACTERISTICS

4.1 Absolute Maximum Ratings at Ta=25°C

| Parameter | Symbol | Min | Max | Unit | Note |
|--------------------------------|-----------------------|------|----------|------|------|
| Storage Temperature | T_{stg} | -55 | +150 | °C | |
| Operating Temperature | T_{opr} | -40 | +105 | °C | |
| Total Output Supply Voltage | $(V_{CC}-V_{EE})$ | 0 | 35 | V | |
| Average Forward Input Current | I_F | | 25 | mA | |
| Reverse Input Voltage | V_R | | 5 | V | |
| Peak Transient Input Current | $I_{F(TRAN)}$ | | 1 | A | 1 |
| “High” Peak Output Current | $I_{OH(PEAK)}$ | | 1.5 | A | 2 |
| “Low” Peak Output Current | $I_{OL(PEAK)}$ | | 1.5 | A | 2 |
| Input Current (Rise/Fall Time) | $t_{r(IN)}/t_{f(IN)}$ | | 500 | ns | 3 |
| Output Voltage | $V_{O(PEAK)}$ | -0.5 | V_{CC} | V | |
| Power Dissipation | P_I | | 45 | mW | |
| Output Power Dissipation | P_O | | 600 | mW | |
| Total Power Dissipation | P_T | | 645 | mW | |
| Lead Solder Temperature | T_{sol} | | 260 | °C | |

Note: Ambient temperature = 25°C, unless otherwise specified. Stresses exceeding the absolute maximum ratings can cause permanent damage to the device. Exposure to absolute maximum ratings for long periods of time can adversely affect reliability.

Note: Note: A ceramic capacitor (0.1 μF) should be connected between pin 6 and pin 4 to stabilize the operation of a high gain linear amplifier. Otherwise, this Photocoupler may not switch properly. The bypass capacitor should be placed within 1 cm of each pin.

Note 1: Pulse width (PW) ≤ 1 μs, 300 pps

Note 2: Exponential waveform. Pulse width ≤ 0.3 μs, f ≤ 15 kHz

Note 3: The rise and fall times of the input on-current should be less than 500 ns

4.2 Recommended Operating Conditions

| Parameter | Symbol | Min. | Max. | Unit |
|-----------------------|--------------|------|------|------|
| Operating Temperature | T_A | -40 | 105 | °C |
| Supplier Voltage | V_{CC} | 10 | 30 | V |
| Input Current (ON) | $I_{F(ON)}$ | 7 | 12 | mA |
| Input Voltage (OFF) | $V_{F(OFF)}$ | -3.0 | 0.8 | V |

Photocoupler LTV-155E-L series

4.3 Electrical optical characteristics at Ta=25°C

| | Parameter | Symbol | Min. | Typ. | Max. | Unit | Test Condition | Figure | Note |
|-----------------|-----------------------------------------------|-------------------------|----------------|-----------------|----------------|--------------------------------------|------------------------------------------------|----------|------|
| Input | Input Forward Voltage | V_F | 1.2 | 1.37 | 1.8 | V | $I_F = 10\text{mA}$ | 13 | — |
| | Input Forward Voltage Temperature Coefficient | $\Delta V_F / \Delta T$ | — | -1.237 | — | mV/°C | $I_F = 10\text{mA}$ | — | — |
| | Input Reverse Voltage | BV_R | 5 | — | — | V | $I_R = 10\mu\text{A}$ | — | — |
| | Input Threshold Current (Low to High) | I_{FLH} | — | 2 | 5 | mA | $V_O > 5\text{V}, I_O = 0\text{A}$ | 6, 7, 18 | — |
| | Input Threshold Voltage (High to Low) | V_{FHL} | 0.8 | — | — | V | $V_O < 5\text{V}, I_O = 0\text{A}$ | — | — |
| | Input Capacitance | C_{IN} | — | 33 | — | pF | $f = 1\text{MHz}, V_F = 0\text{V}$ | — | — |
| Output | High Level Supply Current | I_{CCH} | — | 1.7 | 3.0 | mA | Output Open, $I_F = 7\text{ to }16\text{mA}$ | 4, 5 | — |
| | Low Level Supply Current | I_{CCL} | — | 2.0 | 3.0 | mA | Output Open, $V_F = -3\text{ to }+0.8\text{V}$ | | — |
| | High level output current | I_{OH} | — | — | -0.4 | A | $V_O = (V_{CC} - 2\text{V})$ | 16 | 1 |
| | | | — | — | -1.5 | | $V_O = (V_{CC} - 6\text{V})$ | | 2 |
| | Low level output current | I_{OL} | 0.4 | — | — | A | $V_O = (V_{EE} + 2\text{V})$ | 17 | 1 |
| | | | 1.5 | — | — | | $V_O = (V_{EE} + 6\text{V})$ | | 2 |
| | High level output voltage | V_{OH} | $V_{CC} - 0.6$ | $V_{CC} - 0.3$ | — | V | $I_F = 10\text{mA}, I_O = -100\text{mA}$ | 1, 2, 14 | — |
| | Low level output voltage | V_{OL} | — | $V_{EE} + 0.25$ | $V_{EE} + 0.4$ | V | $I_F = 0\text{mA}, I_O = 100\text{mA}$ | 3, 15 | — |
| | UVLO Threshold | V_{UVLO+} | 6.9 | 7.8 | 8.7 | V | $V_O > 5\text{V}, I_F = 10\text{mA}$ | 19 | — |
| V_{UVLO-} | | 5.9 | 6.7 | 7.5 | V | $V_O < 5\text{V}, I_F = 10\text{mA}$ | — | | |
| UVLO Hysteresis | $UVLO_{HYS}$ | — | 1.1 | — | V | | — | — | |

All Typical values at $T_A = 25^\circ\text{C}$ and $V_{CC} - V_{EE} = 30\text{V}$, unless otherwise specified; all minimum and maximum specifications are at recommended operating condition. (Refer to 4.2)

Note 1: Maximum pulse width = 50 μs .

Note 2: Maximum pulse width = 10 μs .

Photocoupler LTV-155E-L series

5. SWITCHING SPECIFICATION

| Parameter | Symbol | Min. | Typ. | Max. | Unit | Test Condition | Figure | Note |
|----------------------------------------------------------------|-----------|------|------|------|-------------|-----------------------------------------------------------------------------------------------------------------------------------------------------------------------------------|----------------------------|------|
| Propagation Delay Time to High Output Level | t_{PHL} | 50 | — | 200 | ns | $R_g = 47\Omega$, $C_g = 3nF$, $f = 10\text{ kHz}$, Duty Cycle = 50% $I_F = 7\text{ to }16\text{ mA}$, $V_{CC} = 15\text{ to }30V$ $V_{EE} = \text{ground}$ | 8, 9, 10, 11, 12, 20 | — |
| Propagation Delay Time to Low Output Level | t_{PLH} | 50 | — | 200 | | | | — |
| Pulse Width Distortion | PWD | — | 15 | 70 | | | | — |
| Propagation delay difference between any two parts or channels | PDD | 100 | — | 100 | | | 3 | |
| Output Rise Time (20 to 80%) | T_r | — | 35 | — | | | 20 | — |
| Output Fall Time (80 to 20%) | T_f | — | 35 | — | | | | — |
| Common mode transient immunity at high level output | $ CM_H $ | 35 | — | — | kV/ μ s | $T_A = 25^\circ\text{C}$, $I_F = 10\text{ to }16\text{ mA}$, $V_{CM} = 1500\text{ V}$, $V_{CC} = 30\text{ V}$ | 21 | 1 |
| Common mode transient immunity at low level output | $ CM_L $ | 35 | — | — | kV/ μ s | $T_A = 25^\circ\text{C}$, $V_F = 0\text{ V}$, $V_{CM} = 1500\text{ V}$, $V_{CC} = 30\text{ V}$ | | 2 |

All Typical values at $T_A = 25^\circ\text{C}$ and $V_{CC} - V_{EE} = 30\text{ V}$, unless otherwise specified; all minimum and maximum specifications are at recommended operating condition. (Refer to 4.2)

Note 1: CM_H is the maximum rate of rise of the common mode voltage that can be sustained with the output voltage in the logic high state ($V_O > 15\text{ V}$).

Note 2: CM_L is the maximum rate of fall of the common mode voltage that can be sustained with the output voltage in the logic low state ($V_O < 1\text{ V}$).

Note 3: The difference between t_{PHL} and t_{PLH} between any two parts series parts under same test conditions.

Photocoupler LTV-155E-L series

6. ISOLATION CHARACTERISTICS

| Parameter | Test Conditions | Symbol | Min. | Typ | Max. | Unit | Note |
|-----------------------------------|-------------------------------------------------|------------------|------|------------------|------|------|------|
| Withstand Insulation Test Voltage | RH ≤ 40-60%, t = 1min, T _A = 25°C | V _{ISO} | 3750 | — | — | V | 1, 2 |
| Input-Output Resistance | V _{I-O} = 500V DC | R _{I-O} | — | 10 ¹² | — | Ω | 1 |
| Input-Output Capacitance | f = 1MHz, T _A = 25°C | C _{I-O} | — | 0.92 | — | pF | 1 |

All Typical values at T_A = 25°C unless otherwise specified. All minimum and maximum specifications are at recommended operating condition. (Refer to 4.2)

Note 1: Device is considered a two terminal device: pins 1 and 3 are shorted together and pins 4, 5 and 6 are shorted together.

Note 2: According to UL1577, each photocoupler is tested by applying an insulation test voltage 4500V_{RMS} for one second (leakage current less than 10uA). This test is performed before the 100% production test for partial discharge

Photocoupler LTV-155E-L series

7. TYPICAL PERFORMANCE CURVES & TEST CIRCUITS

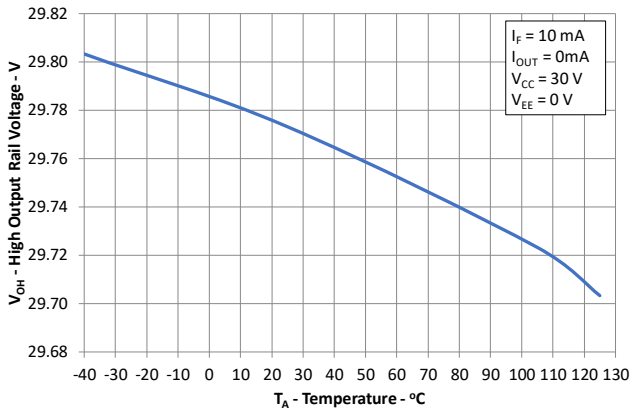

Figure 1: High output rail voltage vs. Temperature

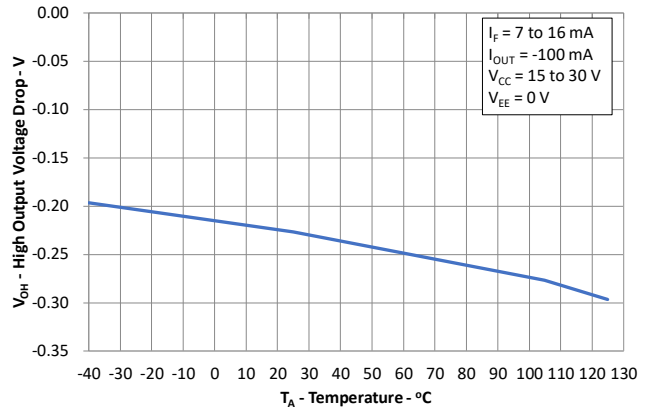

Figure 2: V_{OH} vs. Temperature

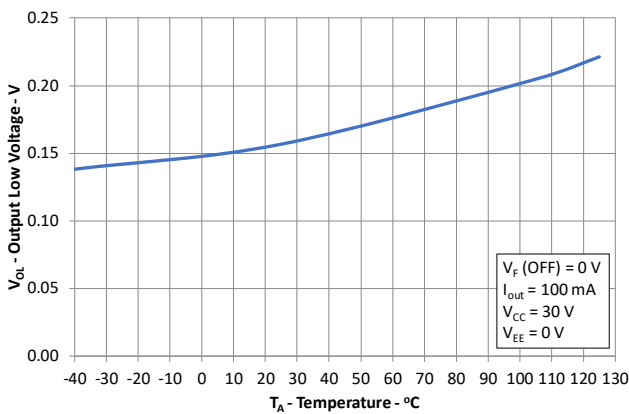

Figure 3: V_{OL} vs. Temperature

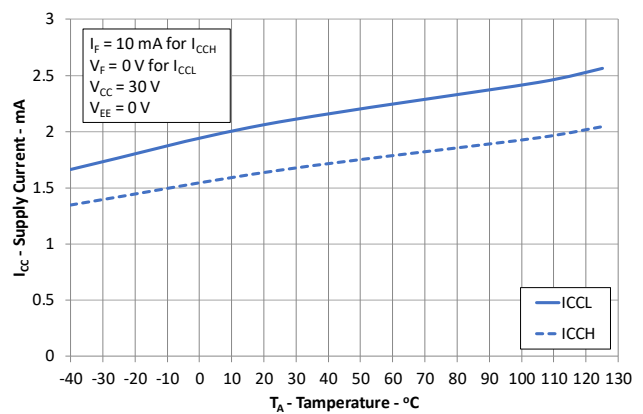

Figure 4: I_{CC} vs. Temperature

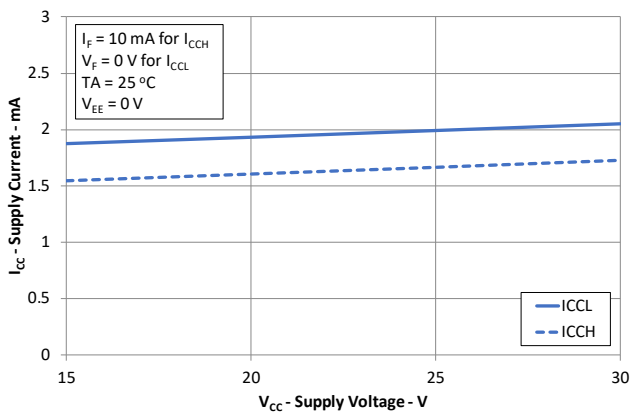

Figure 5: I_{CC} vs. V_{CC}

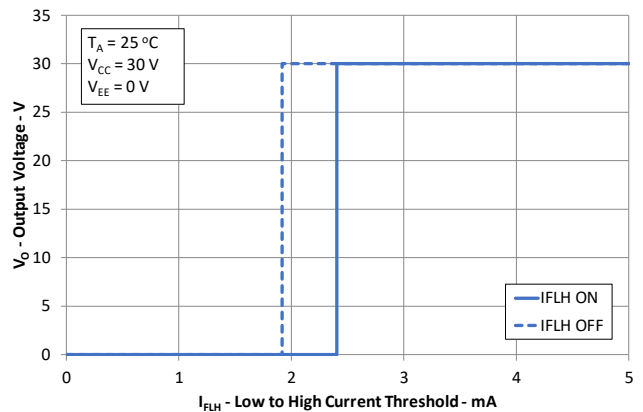

Figure 6: I_{FLH} Hysteresis

Photocoupler LTV-155E-L series

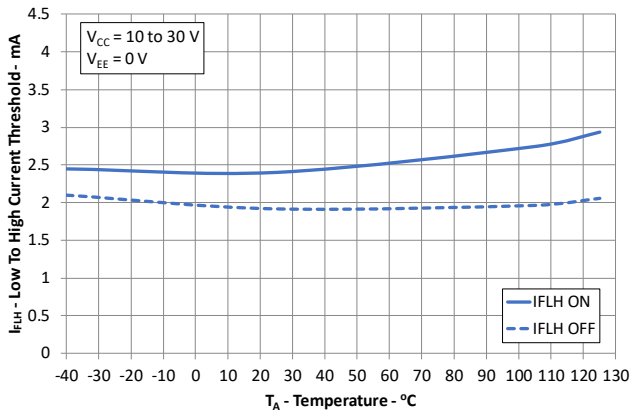

Figure 7: I_{FLH} vs. Temperature

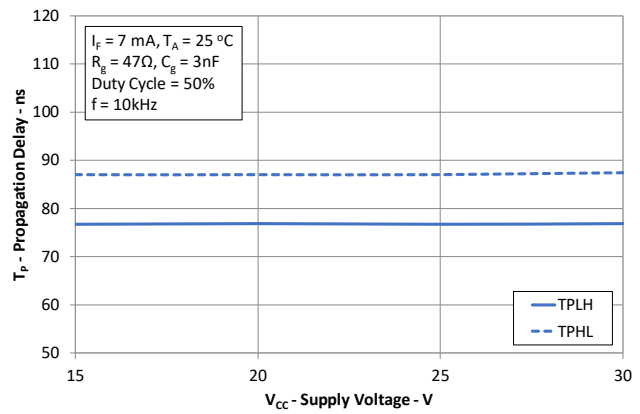

Figure 8: Propagation Delays vs. V_{CC}

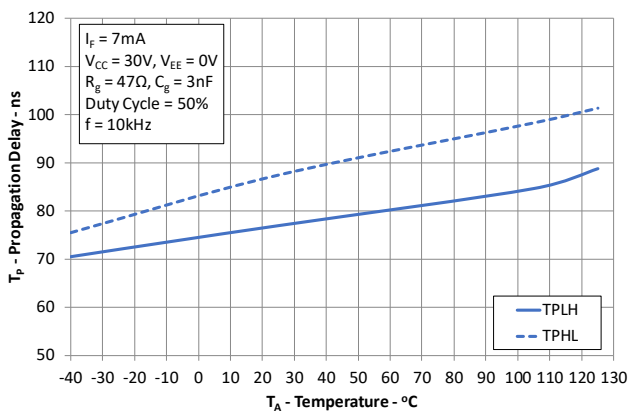

Figure 9: Propagation Delays vs. I_F

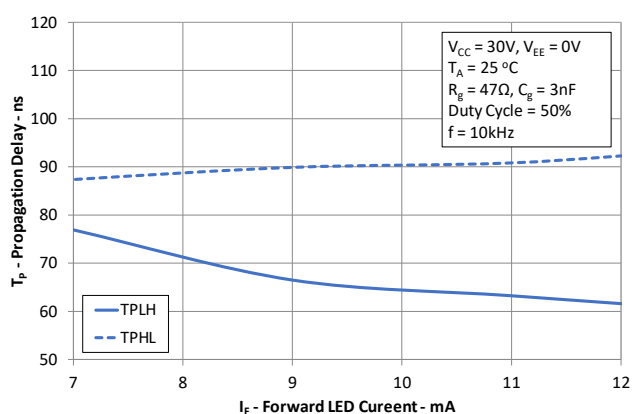

Figure 10: Propagation Delays vs. Temperature

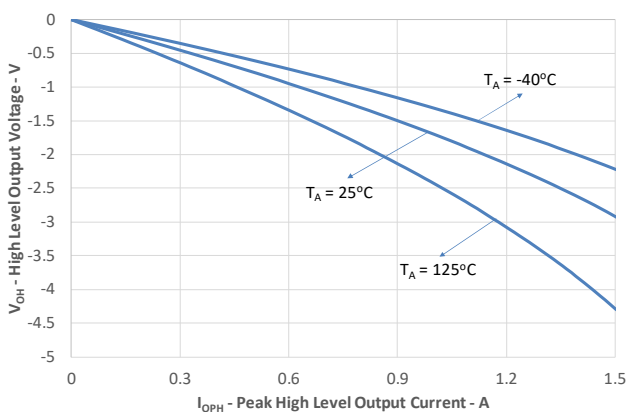

Figure 11: V_{OH} vs. I_{OPH}

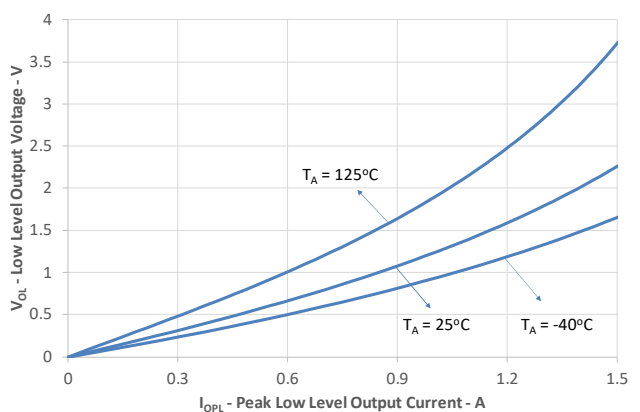

Figure 12: V_{OL} vs. I_{OPL}

Photocoupler LTV-155E-L series

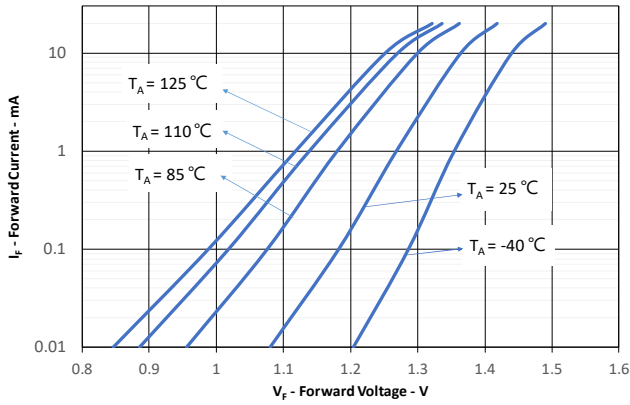

Figure 13 : I_F vs. V_F

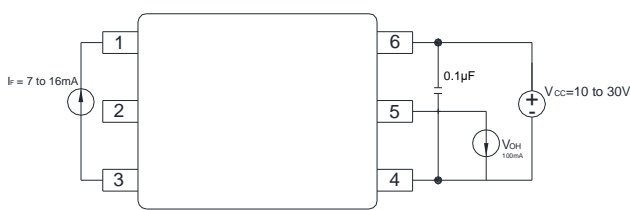

Figure 14 : V_{OH} Test Circuit

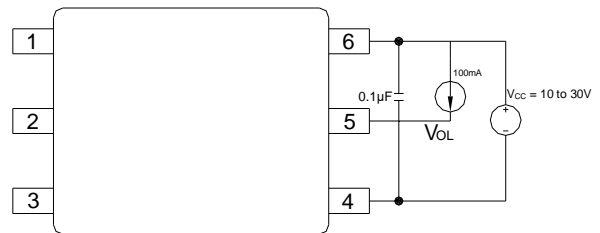

Figure 15 : V_{OL} Test Circuit



Figure 16 : I_{OH} Test Circuit

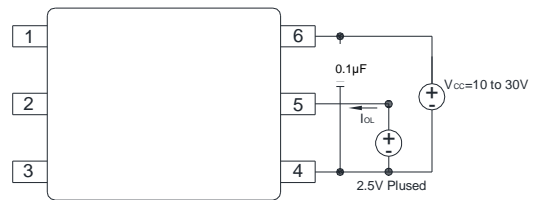

Figure 17 : I_{OL} Test Circuit

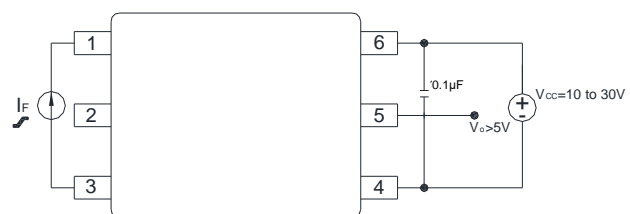

Figure 18 : I_{FLH} Test Circuit



Figure 19 : UVLO Test Circuit

Photocoupler LTV-155E-L series

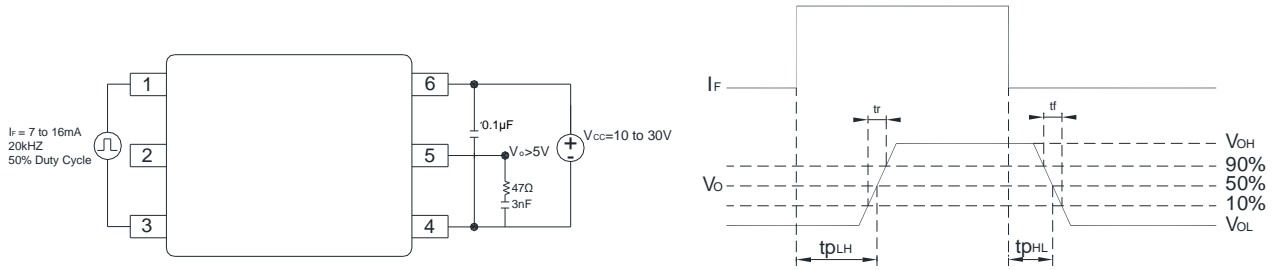

Figure 20 : t_r , t_f , t_{PLH} and t_{PHL} Test Circuit and Waveforms

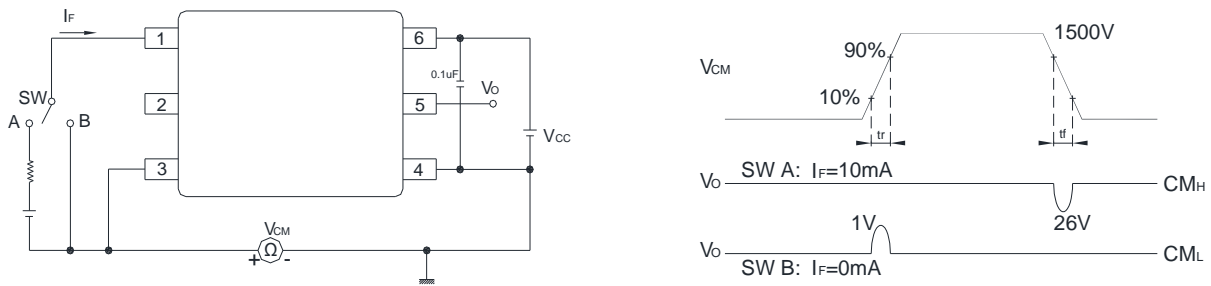

Figure 21 : CMR Test Circuit and Waveforms

Photocoupler LTV-155E-L series

8. TEMPERATURE PROFILE OF SOLDERING

8.1 IR Reflow soldering (JEDEC-STD-020C compliant)

One time soldering reflow is recommended within the condition of temperature and time profile shown below. Do not solder more than three times.

| Profile item | Conditions |
|----------------------------------|----------------|
| Preheat | |
| - Temperature Min (T_{Smin}) | 150°C |
| - Temperature Max (T_{Smax}) | 200°C |
| - Time (min to max) (ts) | 90±30 sec |
| Soldering zone | |
| - Temperature (T_L) | 217°C |
| - Time (t_L) | 60 sec |
| Peak Temperature (T_P) | 260°C |
| Ramp-up rate | 3°C / sec max. |
| Ramp-down rate | 3~6°C / sec |

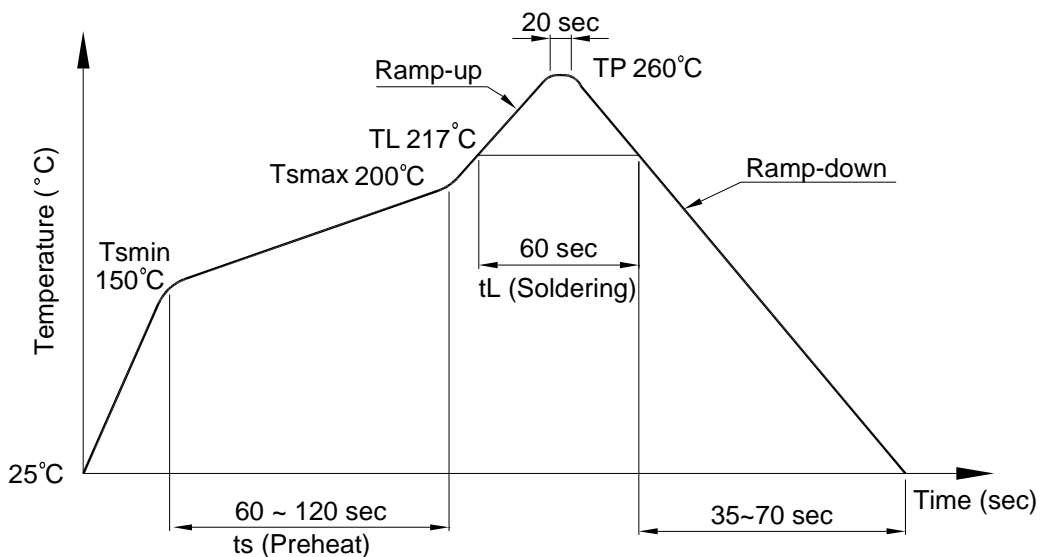

Photocoupler LTV-155E-L series

8.2 Wave soldering (JEDEC22A111 compliant)

One time soldering is recommended within the condition of temperature.

Temperature: $260 \pm 0 / -5^{\circ}\text{C}$

Time: 10 sec.

Preheat temperature: 25 to 140°C

Preheat time: 30 to 80 sec.

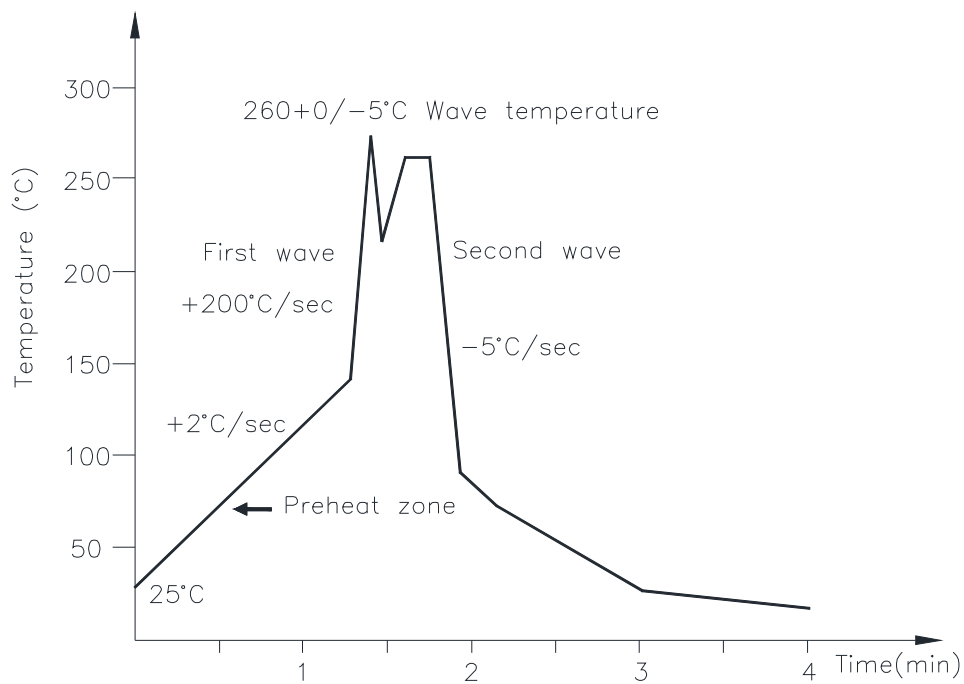

8.3 Hand soldering by soldering iron

Allow single lead soldering in every single process. One time soldering is recommended.

Temperature: $380 \pm 0 / -5^{\circ}\text{C}$

Time: 3 sec max.

**Photocoupler
LTV-155E-L series**

9. NAMING RULE

| Part Number Options | |
|---------------------|--|
| LTV-155E-L | |
| LTV155E-V-L | |

| Definition of Suffix | Remark |
|----------------------|-------------------------------------------|
| "155E-L" | LiteOn model name |
| "no suffix" | Pin 1 location at upper right of the tape |
| "V" | VDE approved option |

10. Notes:

- LiteOn is continually improving the quality, reliability, function or design and LiteOn reserves the right to make changes without further notices.
- The products shown in this publication are designed for the general use in electronic applications such as office automation equipment, communications devices, audio/visual equipment, electrical application and instrumentation.
- For equipment/devices where high reliability or safety is required, such as space applications, nuclear power control equipment, medical equipment, etc, please contact our sales representatives.
- When requiring a device for any "specific" application, please contact our sales in advice.
- If there are any questions about the contents of this publication, please contact us at your convenience.
- The contents described herein are subject to change without prior notice.
- Immerge unit's body in solder paste is not recommended.