

SM520BF thru SM5100BF

Schottky Barrier Rectifiers

Reverse Voltage 20 to 100V Forward Current 5.0A

FEATURES

- * Plastic package has Underwriters Laboratory Flammability Classification 94V-0
- * Low power loss, high efficiency
- * For use in low voltage high frequency inverters, free wheeling, and polarity protection applications
- * Guardring for over voltage protection
- * High temperature soldering guaranteed: 260°C/10 seconds at terminals

Mechanical Data

Case: JEDEC SMB-FL

molded plastic over glass die

Terminals: Plated leads, solderable per MIL-STD-750, Method 2026

Polarity: Color band denotes cathode end

Mounting Position: Any

Weight: 0.066 g

Handling precaution: None

Electrical Characteristic

1. Maximum Ratings & Thermal Characteristics Ratings at 25°C ambient temperature unless otherwise specified.

Parameter Symbol	symbol	SM520 BF	SM530 BF	SM540 BF	SM545 BF	SM550 BF	SM560 BF	SM580 BF	SM5100 BF	Unit
device marking code		S52	S53	S54	S545	S55	S56	S58	S510	
Maximum repetitive peak reverse voltage	V_{RRM}	20	30	40	45	50	60	80	100	V
Maximum RMS voltage	V_{RMS}	14	21	28	31.5	35	42	56	70	V
Maximum DC blocking voltage	V_{DC}	20	30	40	45	50	60	80	100	V
Maximum average forward rectified current lead length at TC = 75°C	$I_{F(AV)}$	5.0								A
Peak forward surge current 8.3ms single half sine-wave superimposed on rated load (JEDEC Method)	I_{FSM}	150								A
Typical thermal resistance (Note1)	$R_{\theta JA}$ $R_{\theta JC}$	150 30								°C/W
Operating junction and storage temperature range	T_J , T_{STG}	-40 to +150								°C

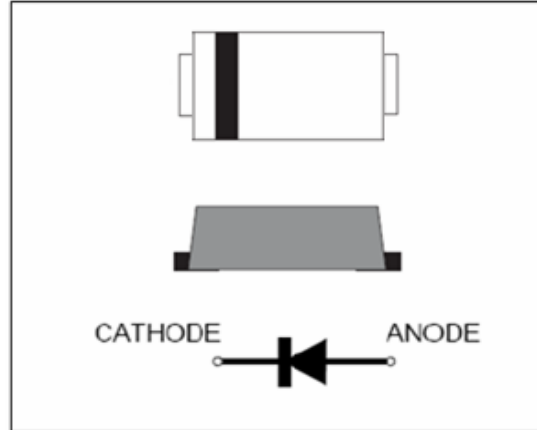

we declare that the material of product is halogen free (green epoxy compound).

Electrical Characteristics Ratings at 25°C ambient temperature unless otherwise specified.

Parameter Symbol	symbol	SM520 BF	SM530 BF	SM540 BF	SM545 BF	SM550 BF	SM560 BF	SM580 BF	SM5100 BF	Unit
Maximum instantaneous forward voltage at 5.0A	V_F	0.55				0.70		0.85		V
Maximum DC reverse current $T_A = 25^\circ\text{C}$ at rated DC blocking voltage $T_J = 100^\circ\text{C}$	I_R					0.5 10.0				mA
Typical junction capacitance at 4.0V, 1MHz	C_J					240				PF

NOTES:

1. 8.0mm2 (.013mm thick) land areas

SM520BF thru SM5100BF

2. Ratings and Characteristic Curves (TA = 25°C unless otherwise noted)

Fig. 1 - Forward Current Derating Curve

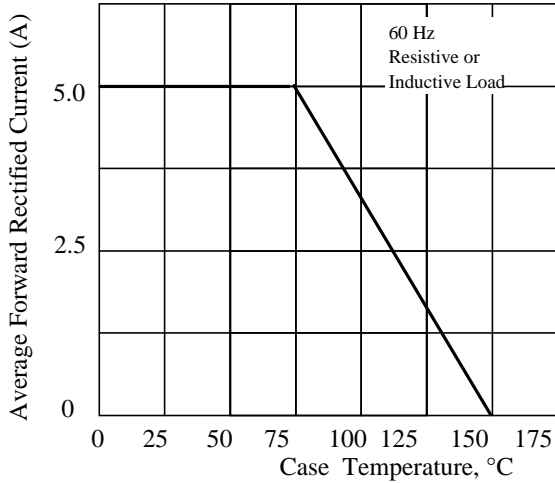

Fig. 2 - Maximum Non-repetitive Peak Forward Surge Current

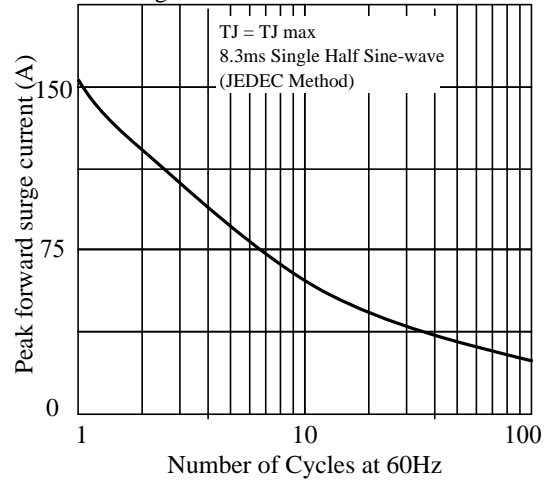

Fig 3. - Typical Instantaneous Forward Characteristics

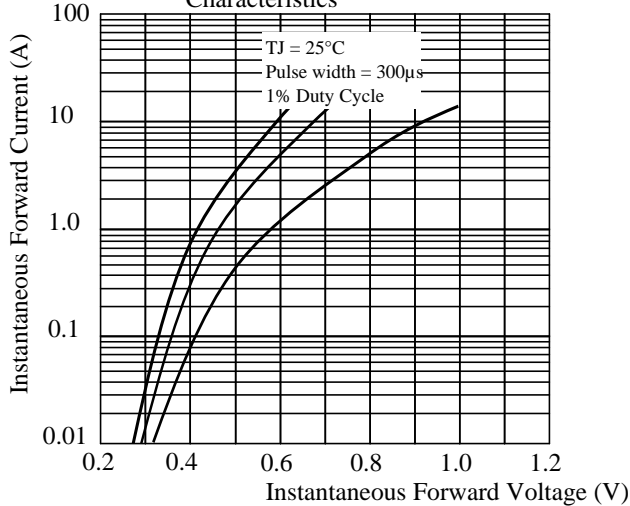

Fig 4. - Typical Reverse Characteristics

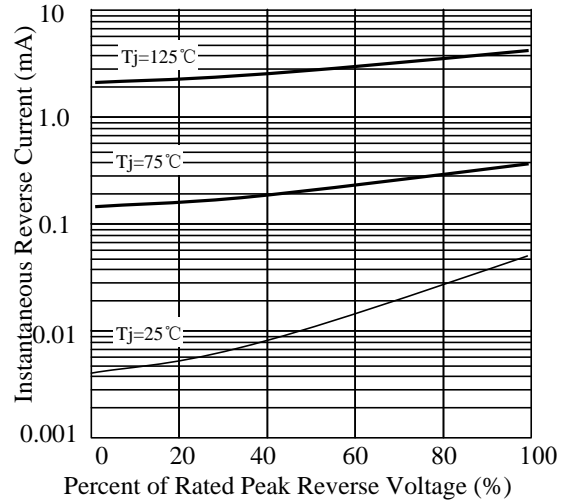

Fig 5. - typical transient thermal impedance

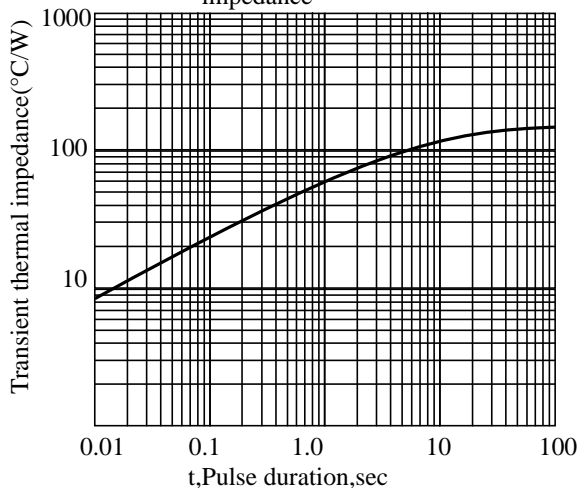
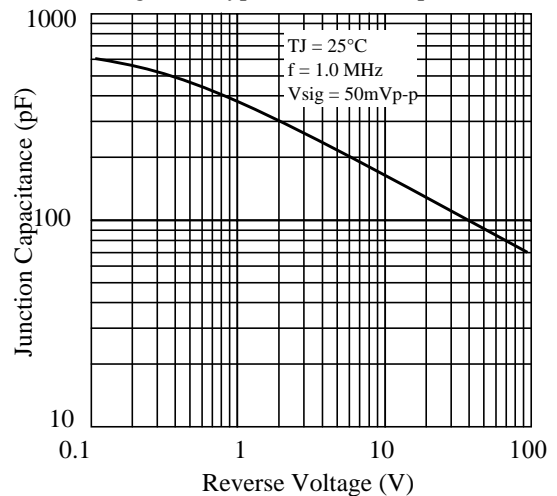

Fig 6. - Typical Junction Capacitance



SM520BF thru SM5100BF

3. dimension:

SMB-FL

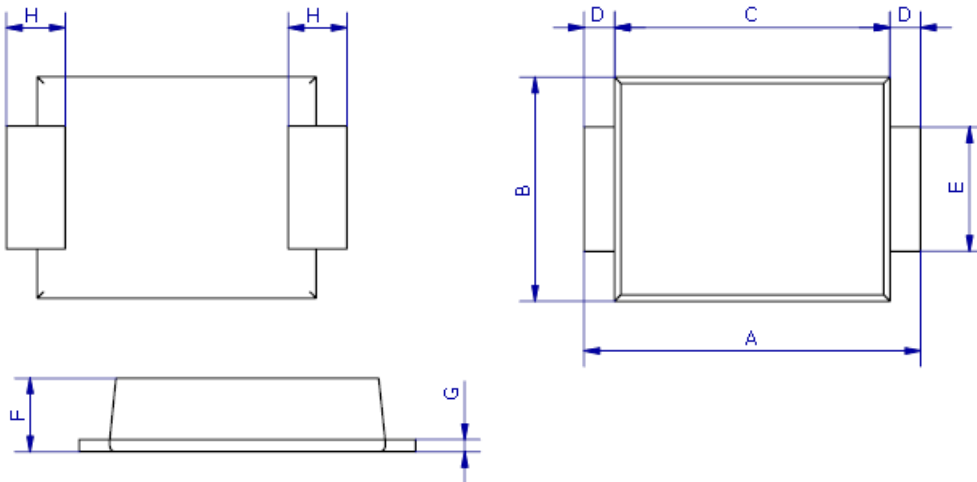

DIM	MILLIMETERS		INCHES	
	MIN	MAX	MIN	MAX
A	5.3	5.7	0.209	0.224
B	3.4	3.8	0.134	0.150
C	4.3	4.7	0.169	0.185
D	0.45Typ		0.018Typ	
E	1.9	2.1	0.0748	0.08268
F	1.05	1.40	0.04134	0.05512
G	0.2	0.3	0.00591	0.00984
H	0.95Typ		0.037Typ	

Mounting Pad Layout

--- SMB-FL

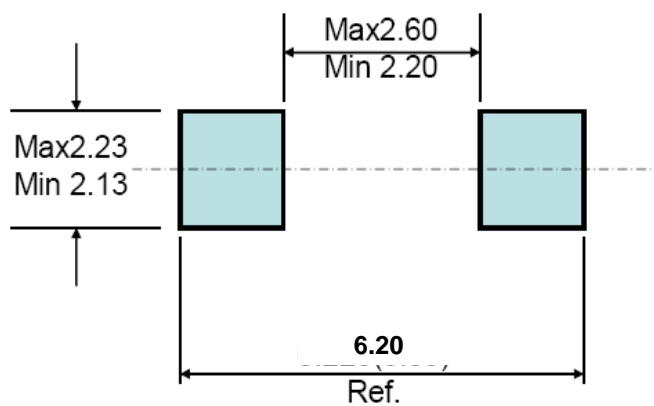

SM520BF thru SM5100BF

4. Update Record

版次	更新记录	更新作者	更新日期
1	第一版	周杰	2014. 04. 30
2	增加SM545BF	周杰	2014. 08. 19
B	VF 0. 5V 变更到0. 55V	谭志伟	2021. 10. 12