

**Product Summary**

- -60V/-3A  
 $R_{DS(ON)} = 95m\Omega$  (Typ) @  $V_{GS} = -10V$   
 $R_{DS(ON)} = 130m\Omega$  (Typ) @  $V_{GS} = -4.5V$
- Reliable and Rugged
- Lead Free and Green Devices Available (RoHS Compliant)

**Application**

- DC-DC Converters.
- Load Switch.
- Power Management.

**Package and Pin Configuration**

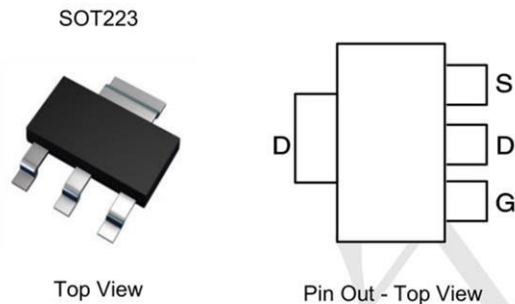

**Circuit diagram**

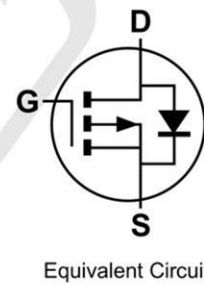

Marking:

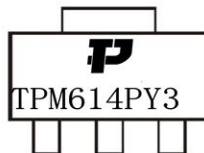

**Absolute Maximum Ratings ( $T_A = 25^\circ C$  unless otherwise noted)**

Characteristic		Symbol	Value	Unit	
Drain-Source Voltage		$V_{DSS}$	-60	V	
Gate-Source Voltage		$V_{GSS}$	$\pm 20$	V	
Continuous Drain Current	$V_{GS} = 10V$	(Note 6)	-4.3	A	
		$T_A = +70^\circ C$ (Note 6)	-3.0		
		(Note 5)	-3.0		
Pulsed Drain Current	$V_{GS} = 10V$	(Note 7)	$I_{DM}$	-13.7	A
Continuous Source Current (Body Diode)		(Note 6)	$I_S$	-4.8	A
Pulsed Source Current (Body Diode)		(Note 7)	$I_{SM}$	-13.7	A

**Thermal Characteristics (@ $T_A = +25^\circ C$ , unless otherwise specified.)**

Characteristic		Symbol	Value	Unit
Power Dissipation	(Note 5)	$P_D$	2.0	W
	(Note 6)		16	
Linear Derating Factor	(Note 5)	$R_{\theta JA}$	3.9	$mW/^\circ C$
	(Note 6)		31	
Thermal Resistance, Junction to Ambient	(Note 5)	$R_{\theta JA}$	62.5	$^\circ C/W$
	(Note 6)		32.0	
Thermal Resistance, Junction to Lead	(Note 8)	$R_{\theta JL}$	9.8	$^\circ C/W$
Operating and Storage Temperature Range		$T_J, T_{STG}$	-55 to +150	$^\circ C$

**Electrical Characteristics (  $T_A = 25^\circ\text{C}$  unless otherwise noted )**

[www.sot23.com.tw](http://www.sot23.com.tw)

Characteristic	Symbol	Min	Typ	Max	Unit	Test Condition
<b>OFF CHARACTERISTICS</b>						
Drain-Source Breakdown Voltage	$BV_{DSS}$	-60	—	—	V	$I_D = -250\mu\text{A}$ , $V_{GS} = 0\text{V}$
Zero Gate Voltage Drain Current	$I_{DSS}$	—	—	-1	$\mu\text{A}$	$V_{DS} = -48\text{V}$ , $V_{GS} = 0\text{V}$
Gate-Source Leakage	$I_{GSS}$	—	—	$\pm 100$	nA	$V_{GS} = \pm 20\text{V}$ , $V_{DS} = 0\text{V}$
<b>ON CHARACTERISTICS</b>						
Gate Threshold Voltage	$V_{GS(th)}$	-2.0	-1.7	-4.0	V	$I_D = -250\mu\text{A}$ , $V_{DS} = V_{GS}$
Static Drain-Source On-Resistance (Note 8)	$R_{DS(on)}$	—	95	120	m $\Omega$	$V_{GS} = -10\text{V}$ , $I_D = -3\text{A}$
			130	190		$V_{GS} = -4.5\text{V}$ , $I_D = -1.9\text{A}$
Forward Transconductance (Notes 8 & 9)	$g_{fs}$	—	4.7	—	S	$V_{DS} = -15\text{V}$ , $I_D = -2.3\text{A}$
Diode Forward Voltage (Note 8)	$V_{SD}$	—	-0.85	-0.95	V	$I_S = -2\text{A}$ , $V_{GS} = 0\text{V}$
Reverse Recovery Time (Note 9)	$t_{rr}$	—	25.1	—	ns	$I_F = -1.7\text{A}$ , $di/dt = 100\text{A}/\mu\text{s}$
Reverse Recovery Charge (Note 9)	$Q_{rr}$	—	27.2	—	nC	
<b>DYNAMIC CHARACTERISTICS (Note 9)</b>						
Input Capacitance	$C_{iss}$	—	637	—	pF	$V_{DS} = -30\text{V}$ , $V_{GS} = 0\text{V}$ $f = 1\text{MHz}$
Output Capacitance	$C_{oss}$	—	70	—	pF	
Reverse Transfer Capacitance	$C_{rss}$	—	53	—	pF	
Total Gate Charge (Note 10)	$Q_g$	—	9.8	—	nC	$V_{GS} = -5\text{V}$
Total Gate Charge (Note 10)	$Q_g$	—	17.7	—	nC	
Gate-Source Charge (Note 10)	$Q_{gs}$	—	1.6	—	nC	$V_{GS} = -10\text{V}$
Gate-Drain Charge (Note 10)	$Q_{gd}$	—	4.4	—	nC	
Turn-On Delay Time (Note 10)	$t_{D(on)}$	—	2.6	—	ns	$V_{DD} = -30\text{V}$ , $V_{GS} = -10\text{V}$ $I_D = -1\text{A}$ , $R_G \cong 6\Omega$
Turn-On Rise Time (Note 10)	$t_r$	—	3.4	—	ns	
Turn-Off Delay Time (Note 10)	$t_{D(off)}$	—	26.2	—	ns	
Turn-Off Fall Time (Note 10)	$t_f$	—	11.3	—	ns	

**Typical Performance Characteristics (  $T_A = 25^\circ\text{C}$  unless otherwise Specified )**

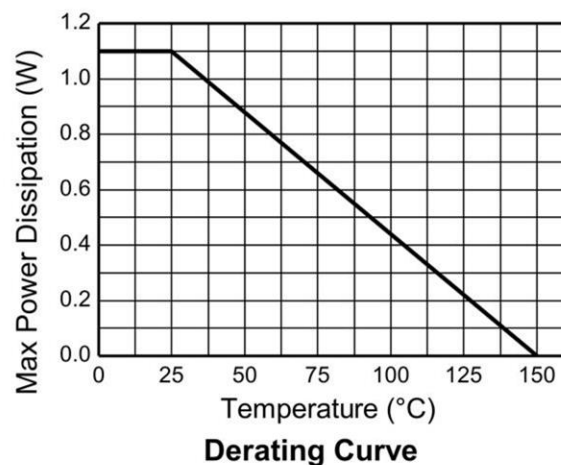
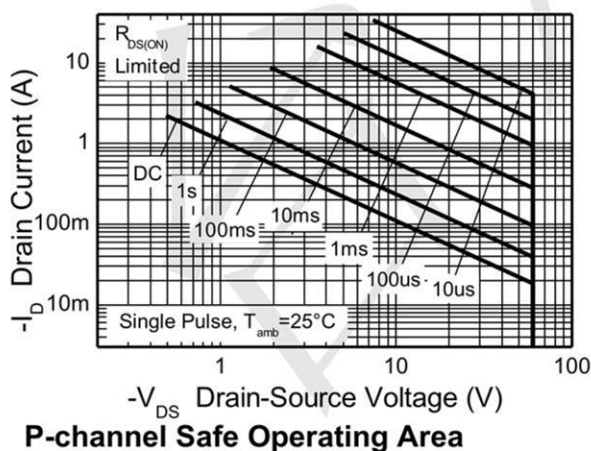

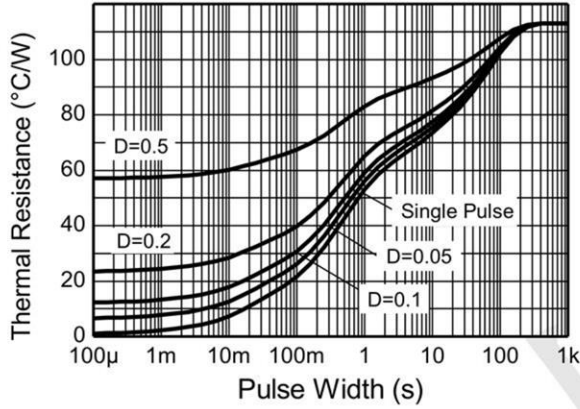

**Transient Thermal Impedance**

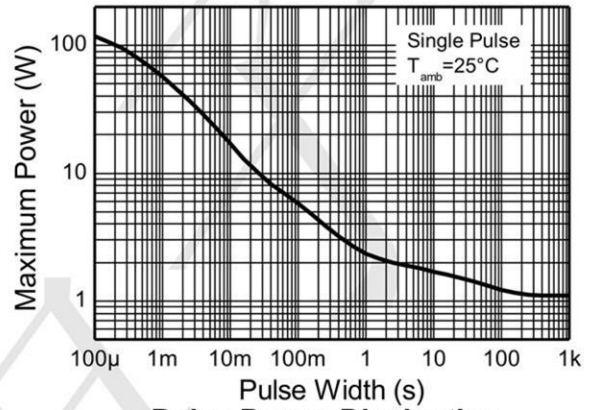

**Pulse Power Dissipation**

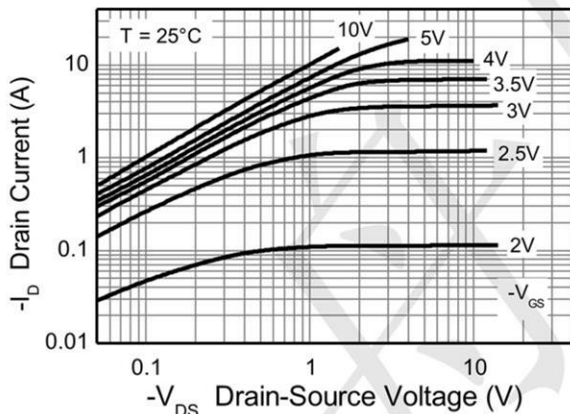

**Output Characteristics**

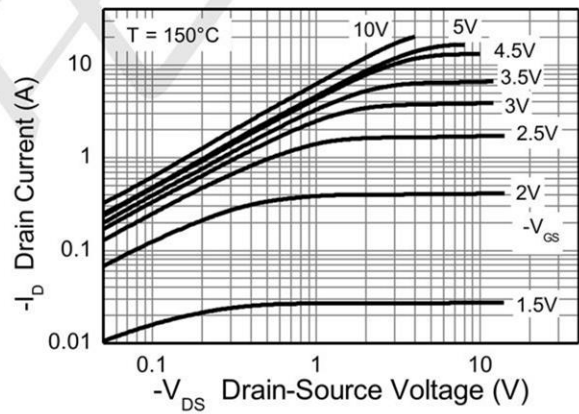

**Output Characteristics**

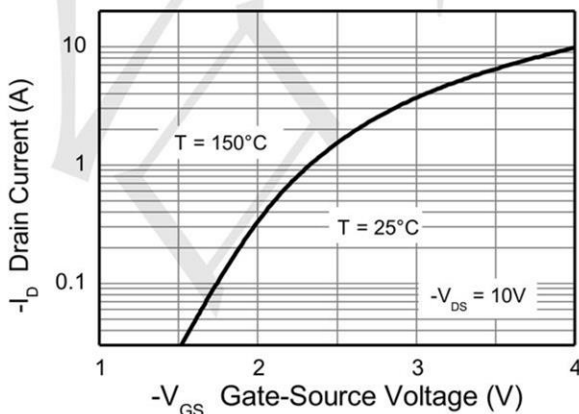

**Typical Transfer Characteristics**

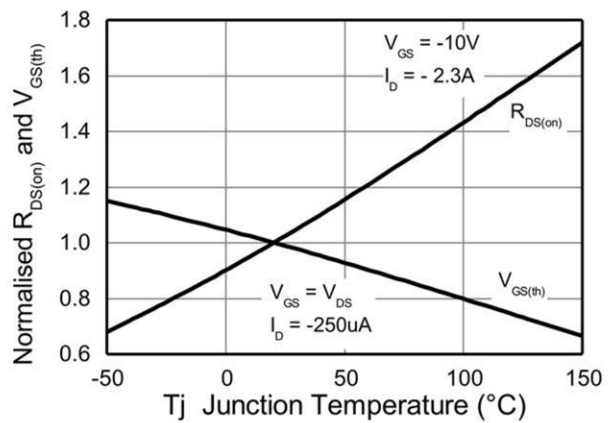

**Normalised Curves v Temperature**



TECH PUBLIC

台丹电子

TPM614PY3

60V P-CHANNEL ENHANCEMENT MODE MOSFET

[www.sot23.com.tw](http://www.sot23.com.tw)

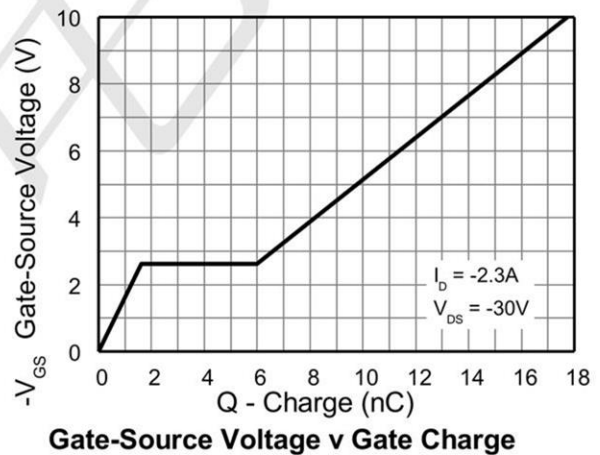
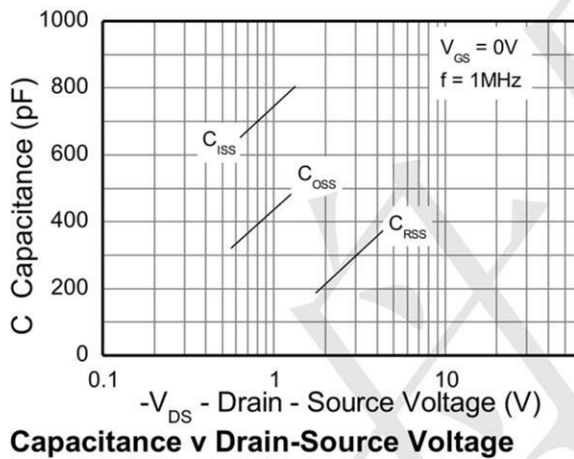
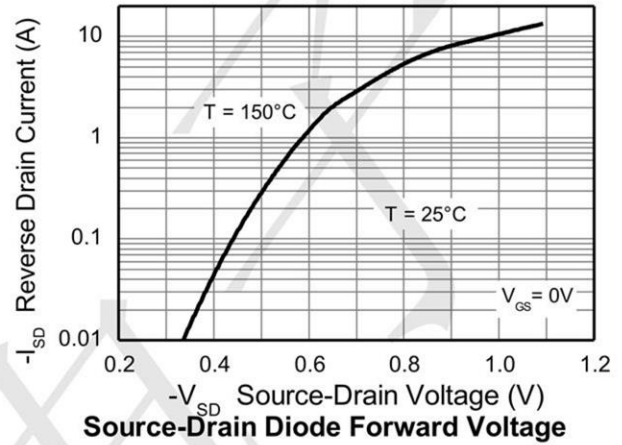
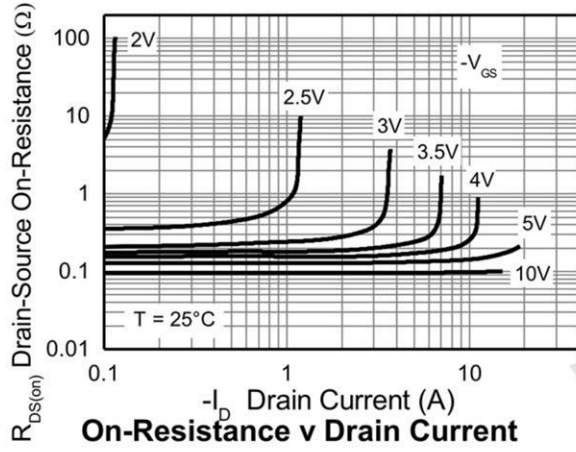



TECH PUBLIC

—台丹电子—

TPM614PY3

60V P-CHANNEL ENHANCEMENT MODE MOSFET

[www.sot23.com.tw](http://www.sot23.com.tw)

SOT223 Package Information

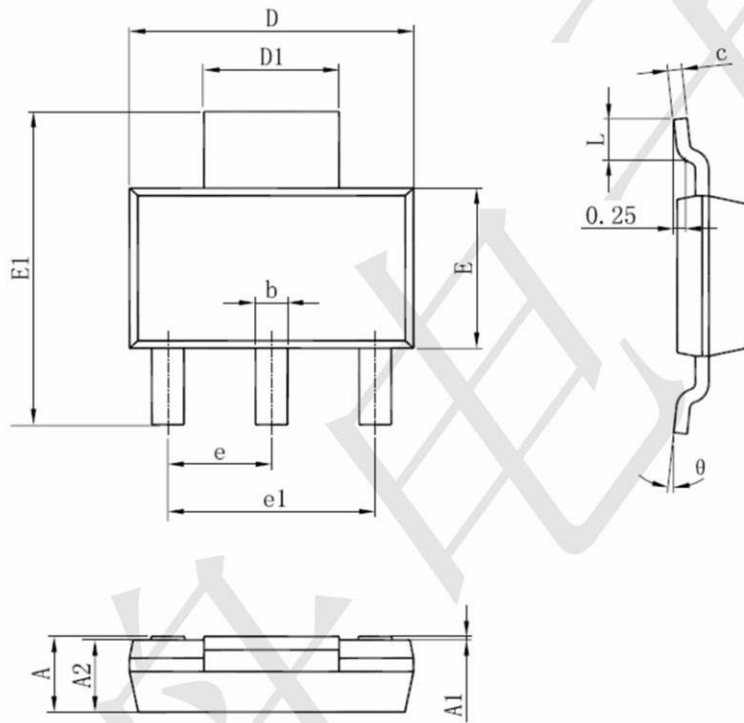

Symbol	Dimensions In Millimeters		Dimensions In Inches	
	Min	Max	Min	Max
A	1.520	1.800	0.060	0.071
A1	0.000	0.100	0.000	0.004
A2	1.500	1.700	0.059	0.067
b	0.660	0.820	0.026	0.032
c	0.250	0.350	0.010	0.014
D	6.200	6.400	0.244	0.252
D1	2.900	3.100	0.114	0.122
E	3.300	3.700	0.130	0.146
E1	6.830	7.070	0.269	0.278
e	2.300(BSC)		0.091(BSC)	
e1	4.500	4.700	0.177	0.185
L	0.900	1.150	0.035	0.045
θ	0°	10°	0°	10°