

Product Summary

BVDSS	RDSON	ID
20V	300mΩ@2.5V	0.9 A

Application

- Load/Power Switching
- Interfacing Switching
- Logic Level Shift

Package and Pin Configuration

SOT-23



Circuit diagram

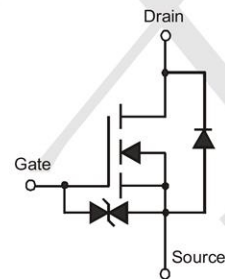

Marking:



Absolute Maximum Ratings (T_A=25°C unless otherwise noted)

Parameter	Symbol	Value	Unit
Drain-Source Voltage	V _{DS}	20	V
Gate-Source Voltage	V _{GS}	±8	V
Continuous Drain Current	I _D	0.9	A
Pulsed Drain Current (t=300μs) ⁽¹⁾	I _{DM}	1.5	A
Power Dissipation ⁽²⁾	P _D	0.35	W
Thermal Resistance from Junction to Ambient	R _{θJA}	357	°C/W
Junction Temperature	T _J	150	°C
Storage Temperature	T _{STG}	-55~ +150	°C

Electrical Characteristics (T_J=25 °C, unless otherwise noted)

Parameter	Symbol	Test Condition	Min	Type	Max	Unit
Static Characteristics						
Drain-source breakdown voltage	V _{(BR)DSS}	V _{GS} = 0V, I _D = 250μA	20	25		V
Zero gate voltage drain current	I _{DSS}	V _{DS} = 20V, V _{GS} = 0V			1	μA
Gate-body leakage current	I _{GSS}	V _{GS} = ±18V, V _{DS} = 0V			±10	μA
Gate threshold voltage ⁽³⁾	V _{GS(th)}	V _{DS} = V _{GS} , I _D = 250μA	0.5	0.7	1.1	V
Drain-source on-resistance ⁽³⁾	R _{DS(on)}	V _{GS} = 4.5V, I _D = 500mA		250	400	mΩ
		V _{GS} = 2.5V, I _D = 500mA		300	500	
Forward transconductance	g _{FS}	V _{DS} = 10V, I _D = 500mA			1.2	S
Dynamic characteristics⁽⁴⁾						
Input Capacitance	C _{iss}	V _{DS} = 10V, V _{GS} = 0V, f = 1MHz		45		pF
Output Capacitance	C _{oss}			9		
Reverse Transfer Capacitance	C _{rss}			6		
Switching Characteristics⁽⁴⁾						
Turn-on delay time	t _{d(on)}	V _{DD} = 10V, I _D = 500mA, V _{GS} = 4.5V, R _G = 6Ω		20		ns
Turn-on rise time	t _r			90		
Turn-off delay time	t _{d(off)}			750		
Turn-off fall time	t _f			400		
Source-Drain Diode characteristics						
Diode Forward voltage ⁽³⁾	V _{DS}	I _S = 0.15A, V _{GS} = 0V			1.3	V

Typical Electrical and Thermal Characteristics

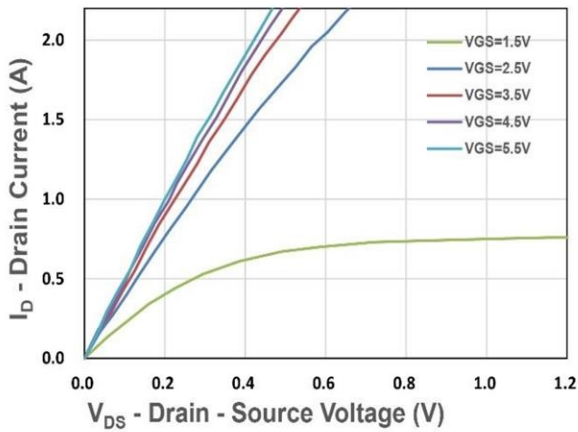

Figure 1. Output Characteristics

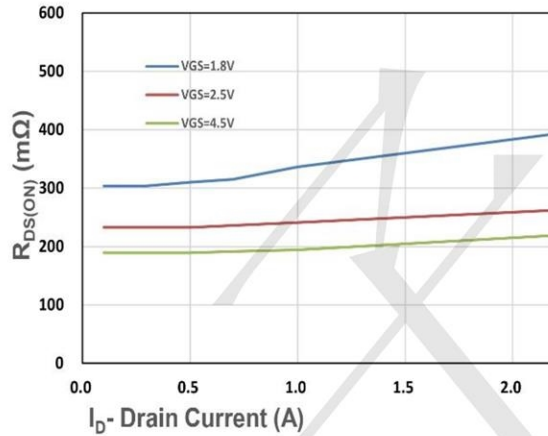

Figure 2. On-Resistance vs. I_D

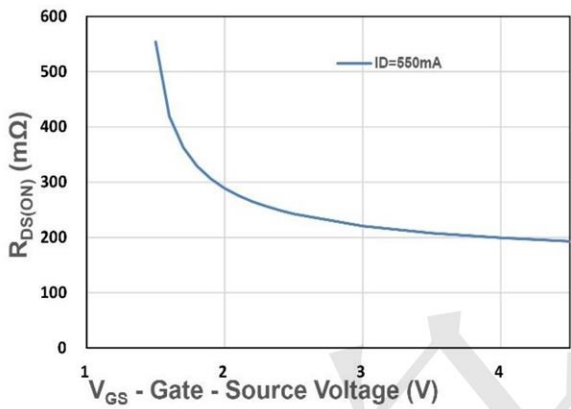

Figure 3. On-Resistance vs. V_{GS}

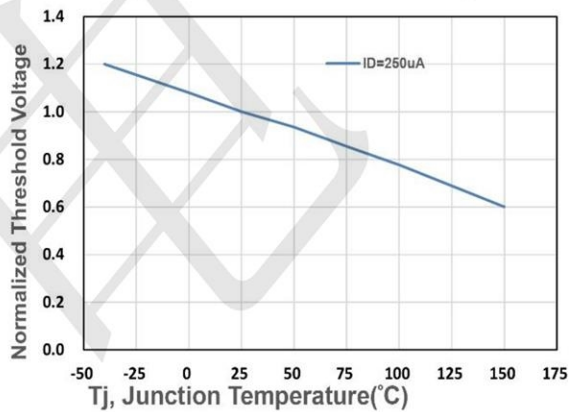

Figure 4. Gate Threshold Voltage

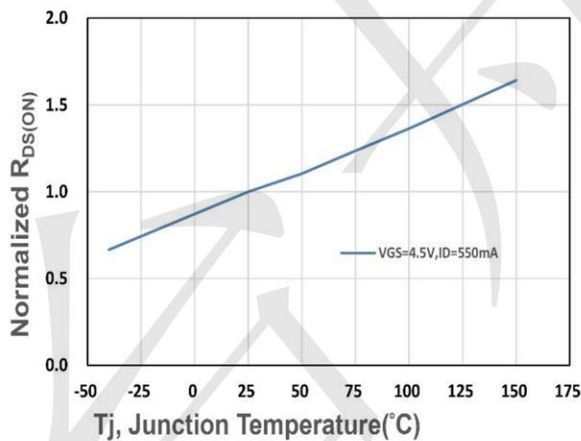

Figure 5. Drain-Source On Resistance

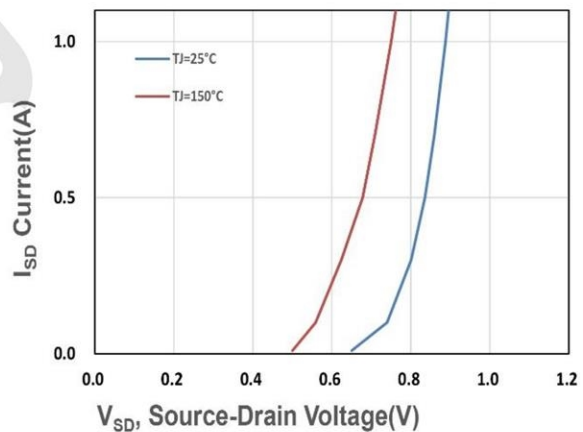
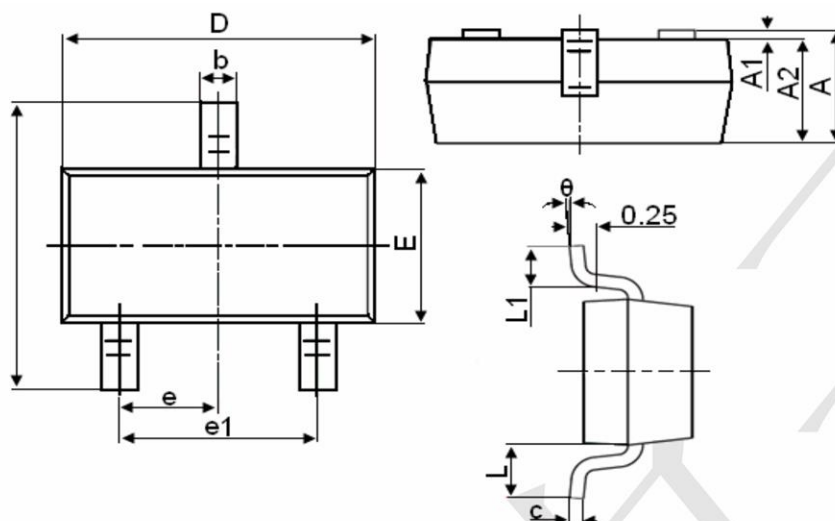

Figure 6. Source-Drain Diode Forward



SOT-23 Package Information



Symbol	Dimensions in Millimeters	
	MIN.	MAX.
A	0.900	1.150
A1	0.000	0.100
A2	0.900	1.050
b	0.300	0.500
c	0.080	0.150
D	2.800	3.000
E	1.200	1.400
E1	2.250	2.550
e	0.950TYP	
e1	1.800	2.000
L	0.550REF	
L1	0.300	0.500
θ	0°	8°