

HVCW-2835FPY

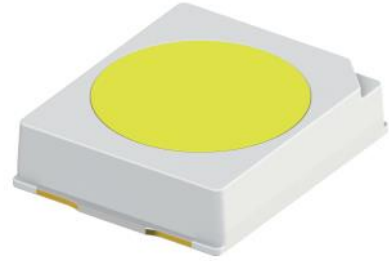

2835 PLCC2 系列产品 / Products Series

具有高发光效率、高一一致性、高稳定性、高可靠性，主要用于汽车应用

High luminous efficiency, consistency, stability and reliability, it is mainly used in automobile applications.

特征

- 外观：白色PCT塑料，荧光硅树脂封装
- 50% I_v 视角：120°
- 颜色：C_x=0.32, C_y=0.32 (CIE1931)
- 资格：可靠性测试符合AEC Q102和 IEC 60810标准
- 潮湿敏感等级-2

Features

- Package: Colored diffused silicone resin in white PCT cup
- Viewing angle at 50% I_v: 120°
- Color: C_x=0.32, C_y=0.32 (acc. to CIE1931)
- Qualifications: Reliability test compliance with AEC Q102 and IEC 60810
- MSL-2

应用

- 信号灯
- 汽车内外部照明应用

Applications

- Signaling
- Interior and exterior lighting for automotive

订购信息 / Ordering Information

型号				发光强度	订单编号
Type				Luminous Intensity $I_v @ I_f = 60\text{mA}$	Ordering Code
HVCW-2835FPY	- XXXX	- XXXX	- XX		
	I	I	I		
	亮度档	色度坐标	电压档	3.55 - 14.00cd	XXXXXX
	Brightness	Chromaticity Coordinate	Forward Voltage		

备注

■ 亮度档

单个最小包装只装有同一个亮度档次的产品，具体分档信息请见第4页

例如：HVCW-2835FPY-CBFA-XXXX-XX，单个卷盘中的产品只有CB、DA、DB、EA、EB、FA中的某一档

■ 色度坐标档

单个最小包装只装有同一个色度坐标档次的产品，具体分档信息请见第5页

例如：HVCW-2835FPY-XXXX-FKOPNO-XXXX，单个卷盘中的产品只有FKO、FLO、GKO、GLO、HKO、HLO……PNO 或 A、B 中的某一档

■ 正向电压档

单个最小包装只装有同一个正向电压档次的产品，具体分档信息请见第4页

例如：HVCW-2835FPY-XXXX-XXXX-58，单个卷盘中的产品只有5、6、7、8中的某一档

Note

■ Brightness Grouping

Only one brightness group will be packed in each reel. Please refer to page #4 for details.

E. g. : HVCW-2835FPY-CBFA-XXXX-XX, means only one bin of CB, DA, DB, EA, EB, FA is in each reel.

■ Chromaticity Coordinate Groups

Only one Chromaticity Coordinate group will be packed in each reel. Please refer to page #5 for details.

E. g. : HVCW-2835FPY-XXXX-FKOPNO-XXXX, means only one bin of FKO, FLO, GKO, GLO, HKO, HLO……PNO or A, B is in one reel.

■ Forward Voltage Groups

Only one forward voltage group will be packed in each reel. Please refer to page #4 for details.

E. g. : HVCW-2835FPY-XXXX-XXXX-58, means only one bin of 5, 6, 7 or 8 is in each reel.

极限参数 / Maximum Ratings

参数 Parameters	符号 Symbol	数值 Rating	单位 Unit
结温 / Junction Temperature	T_j	125	°C
正向电流 / Forward Current ($T_s=25^\circ\text{C}$)	I_f	150	mA
峰值正向电流 Peak Forward Current ($t \leq 10\mu\text{s}$; $D=0.005$; $T_s=25^\circ\text{C}$)	I_{fp}	750	mA
反向电压 / Reverse Voltage ($T_s=25^\circ\text{C}$)	V_r	不适用于反向操作 Not designed for reverse operation	V
抗静电能力 Electrostatic Discharge (HBM)	V_{ESD}	2000	V
操作温度 / Operating Temperature	T_{opr}	-40 ~ +110	°C
储存温度 / Storage Temperature	T_{stg}	-40 ~ +110	°C

特性 / Characteristics ($T_s = 25^\circ\text{C}$; $I_f = 60\text{ mA}$)

参数 Parameters		符号 Symbol	数值 Rating	单位 Unit
色坐标 / Chromaticity coordinates acc. to CIE 1931	typ.	C_x	0.32	-
		C_y	0.32	
50 % I_v 下的视角 / Viewing Angle at 50 % I_v	typ.	2Φ	120	°
	min.	V_f	2.60	V
	typ.	V_f	3.10	V
正向电压 / Forward Voltage	max.	V_f	3.80	V
	typ.	I_r	不可施加反向 电压 / not designed for reverse operation	uA
反向电流 / Reverse Current ($V_R=5\text{V}$)	max.	I_r		uA
实际热阻值 (PN结-焊点) / Real Thermal Resistance (Junction / Solder Point)	max.	$R_{th JS real}$	16	K/W

亮度分档 / Brightness Grouping ($T_s = 25\text{ }^\circ\text{C}$; $I_f = 60\text{ mA}$)

档次 Grouping	发光强度	发光强度	光通量
	Luminous Intensity Φ_v (min.)	Luminous Intensity Φ_v (max.)	Luminous Flux I_v (typ.)
CB	3.55cd	4.50cd	12.10lm
DA	4.50cd	5.60cd	15.20lm
DB	5.60cd	7.10cd	19.10lm
EA	7.10cd	9.00cd	24.20lm
EB	9.00cd	11.20cd	30.30lm
FA	11.20cd	14.00cd	37.80lm

正向电压分档 / Forward Voltage Grouping ($T_s = 25\text{ }^\circ\text{C}$; $I_f = 60\text{ mA}$)

档次 Grouping	正向电压	正向电压
	Forward Voltage V_f (min.)	Forward Voltage V_f (max.)
5	2.60 V	2.90 V
6	2.90 V	3.20 V
7	3.20 V	3.50 V
8	3.50V	3.80 V

颜色色度分档1/Colour Chromaticity Groups 1 ($T_s = 25\text{ }^\circ\text{C}$; $I_f = 60\text{ mA}$)

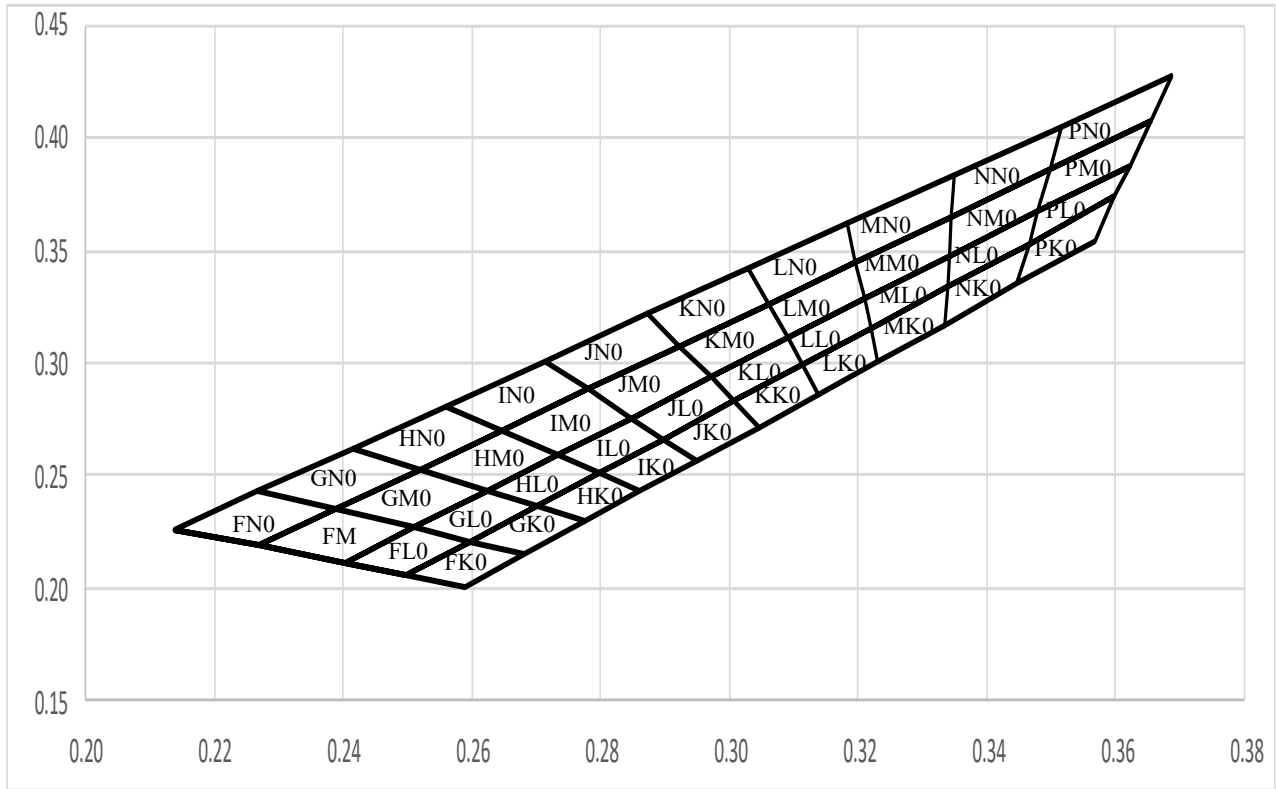

FKO	0.2498	0.2053	HKO	0.2700	0.2361	JKO	0.2898	0.2664
	0.2597	0.2204		0.2797	0.2509		0.3007	0.2830
	0.2682	0.2146		0.2861	0.2427		0.3045	0.2717
	0.2589	0.2000		0.2775	0.2292		0.2950	0.2568
FLO	0.2402	0.2108	HLO	0.2624	0.2431	JLO	0.2848	0.2757
	0.2509	0.2264		0.2733	0.2590		0.2971	0.2935
	0.2597	0.2204		0.2797	0.2509		0.3007	0.2830
	0.2498	0.2053		0.2700	0.2361		0.2898	0.2664
FMO	0.2269	0.2185	HMO	0.2520	0.2527	JMO	0.2780	0.2883
	0.2388	0.2348		0.2646	0.2700		0.2922	0.3077
	0.2509	0.2264		0.2733	0.2590		0.2971	0.2935
	0.2402	0.2108		0.2624	0.2431		0.2848	0.2757
FNO	0.2136	0.2262	HNO	0.2416	0.2623	JNO	0.2712	0.3009
	0.2267	0.2432		0.2559	0.2810		0.2873	0.3219
	0.2388	0.2348		0.2646	0.2700		0.2922	0.3077
	0.2269	0.2185		0.2520	0.2527		0.2780	0.2883

GKO	0.2597	0.2204	IKO	0.2797	0.2509	KKO	0.3007	0.2830
	0.2700	0.2361		0.2898	0.2664		0.3113	0.2992
	0.2775	0.2292		0.2950	0.2568		0.3138	0.2862
	0.2682	0.2146		0.2861	0.2427		0.3045	0.2717
GLO	0.2509	0.2264	ILO	0.2733	0.2590	KLO	0.2971	0.2935
	0.2624	0.2431		0.2848	0.2757		0.3090	0.3108
	0.2700	0.2361		0.2898	0.2664		0.3113	0.2992
	0.2597	0.2204		0.2797	0.2509		0.3007	0.2830
GMO	0.2388	0.2348	IMO	0.2464	0.2700	KMO	0.2922	0.3077
	0.2520	0.2527		0.2780	0.2883		0.3060	0.3266
	0.2624	0.2431		0.2848	0.2757		0.3090	0.3108
	0.2509	0.2264		0.2733	0.2590		0.2971	0.2935
GNO	0.2267	0.2432	INO	0.2559	0.2810	KNO	0.2873	0.3219
	0.2416	0.2623		0.2712	0.3009		0.3030	0.3424
	0.2520	0.2527		0.2780	0.2883		0.3060	0.3266
	0.2388	0.2348		0.2464	0.2700		0.2922	0.3077
LKO	0.3113	0.2992	MMO	0.3196	0.3451	PKO	0.3465	0.3530
	0.3219	0.3154		0.3345	0.3654		0.3599	0.3735
	0.3231	0.3008		0.3341	0.3472		0.3567	0.3535
	0.3138	0.2862		0.3209	0.3281		0.3447	0.3347
LLO	0.3090	0.3108	MNO	0.3183	0.3621	PLO	0.3479	0.3673
	0.3209	0.3281		0.3349	0.3830		0.3623	0.3882
	0.3219	0.3154		0.3345	0.3654		0.3599	0.3735
	0.3113	0.2992		0.3196	0.3451		0.3465	0.3530
LMO	0.3060	0.3266	NKO	0.3339	0.3336	PMO	0.3498	0.3863
	0.3196	0.3451		0.3465	0.3530		0.3655	0.4079
	0.3209	0.3281		0.3447	0.3347		0.3623	0.3882
	0.3090	0.3108		0.3335	0.3172		0.3479	0.3673
LNO	0.3030	0.3424	NLO	0.3341	0.3472	PNO	0.3517	0.4053
	0.3183	0.3621		0.3479	0.3673		0.3687	0.4276
	0.3196	0.3451		0.3465	0.3530		0.3655	0.4079
	0.3060	0.3266		0.3339	0.3336		0.3498	0.3863
MKO	0.3219	0.3154	NMO	0.3345	0.3654			
	0.3339	0.3336		0.3498	0.3863			
	0.3335	0.3172		0.3479	0.3673			
	0.3231	0.3008		0.3341	0.3472			
MLO	0.3209	0.3281	NNO	0.3349	0.3830			
	0.3341	0.3472		0.3517	0.4053			
	0.3339	0.3336		0.3498	0.3863			
	0.3219	0.3154		0.3345	0.3654			

颜色色度分档2/Colour Chromaticity Groups 2 ($T_s = 25\text{ }^\circ\text{C}$; $I_f = 60\text{ mA}$)

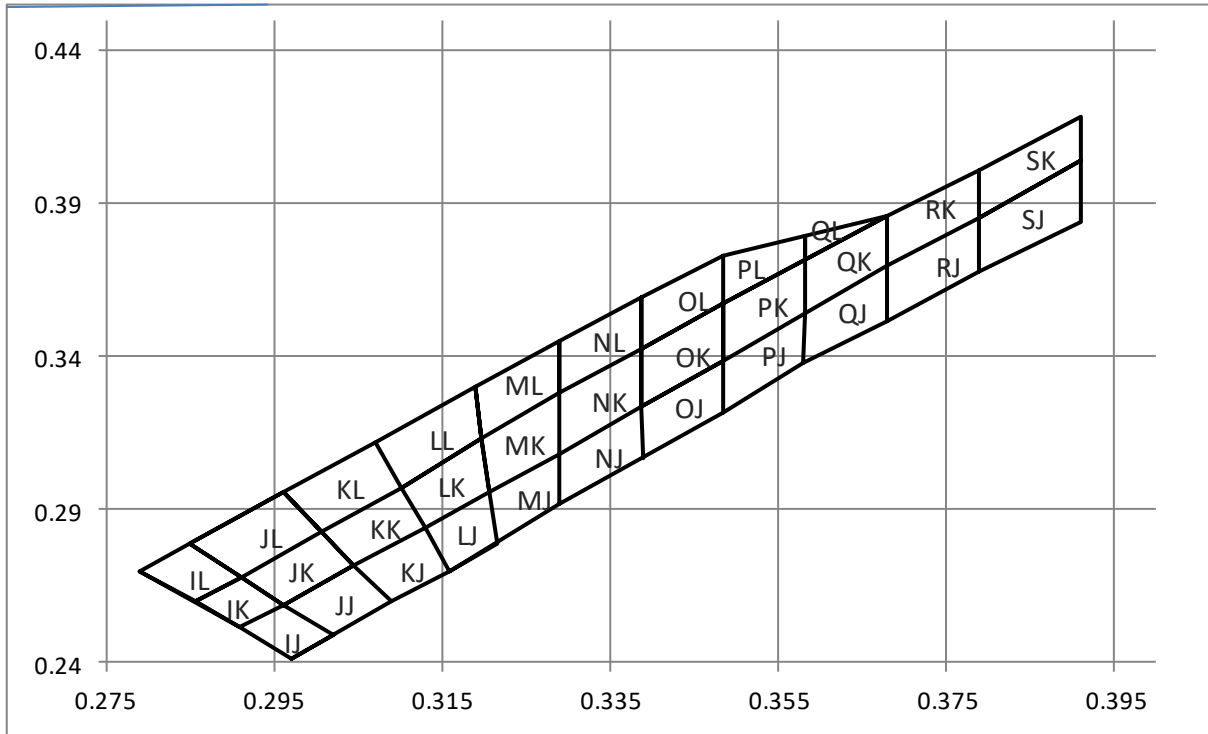

	X	Y		X	Y		X	Y		X	Y
	0.2910	0.2680		0.3100	0.2970		0.3288	0.3081		0.3484	0.3388
JK	0.2960	0.2590	LK	0.3130	0.2840	NK	0.3288	0.3282	PK	0.3484	0.3571
	0.3005	0.2825		0.3197	0.3131		0.3386	0.3235		0.3582	0.3542
	0.3045	0.2715		0.3205	0.2956		0.3386	0.3426		0.3582	0.3715
JL	0.2850	0.2790	LL	0.3070	0.3120	NL	0.3288	0.3282	PL	0.3484	0.3571
	0.2910	0.2680		0.3100	0.2970		0.3288	0.3453		0.3484	0.3730
	0.2960	0.2955		0.3189	0.3302		0.3386	0.3426		0.3582	0.3715
	0.3005	0.2825		0.3197	0.3131		0.3386	0.3591		0.3582	0.3792
KK	0.3005	0.2825	MK	0.3197	0.3131	OK	0.3386	0.3235	QK	0.3582	0.3542
	0.3045	0.2715		0.3205	0.2956		0.3386	0.3426		0.3582	0.3715
	0.3100	0.2970		0.3288	0.3081		0.3484	0.3388		0.368	0.3859
	0.3130	0.2840		0.3288	0.3282		0.3484	0.3571		0.368	0.3695
KL	0.2960	0.2955	ML	0.3189	0.3302	OL	0.3386	0.3426	QL	0.3582	0.3715
	0.3005	0.2825		0.3197	0.3131		0.3386	0.3591		0.3582	0.3792
	0.3070	0.3120		0.3288	0.3282		0.3484	0.3571		0.3680	0.3859
	0.3100	0.2970		0.3288	0.3452		0.3484	0.3730			

颜色色度分档2/Colour Chromaticity Groups 2 ($T_s = 25\text{ }^\circ\text{C}$; $I_f = 60\text{ mA}$)

	X	Y		X	Y		X	Y		X	Y
IJ	0.2960	0.2590	JJ	0.2960	0.2590	KJ	0.3130	0.2840	LJ	0.3205	0.2956
	0.3020	0.2490		0.3045	0.2715		0.3159	0.2700		0.3215	0.2790
	0.2970	0.2410		0.3090	0.2600		0.3090	0.2600		0.3159	0.2700
	0.2908	0.2518		0.2970	0.2410		0.3045	0.2715		0.3130	0.2840
MJ	0.3288	0.3081	NJ	0.3386	0.3235	OJ	0.3484	0.3388	PJ	0.3582	0.3542
	0.3290	0.2920		0.3390	0.3070		0.3485	0.3220		0.3580	0.3380
	0.3159	0.2700		0.3159	0.2700		0.3159	0.2700		0.3485	0.3220
	0.3090	0.2600		0.3090	0.2600		0.3090	0.2600		0.3090	0.2600
QJ	0.368	0.3695	RK	0.3680	0.3859	RJ	0.379	0.385	SK	0.3790	0.4010
	0.368	0.3515		0.3790	0.4010		0.379	0.368		0.3910	0.4180
	0.358	0.338		0.3790	0.3850		0.368	0.3515		0.3910	0.4040
	0.3582	0.3542		0.3680	0.3695		0.368	0.3695		0.3790	0.3850
SJ	0.3790	0.3850									
	0.3910	0.4040									
	0.3910	0.3840									
	0.3790	0.3680									

颜色色度分档2/Colour Chromaticity Groups 2 ($T_s = 25\text{ }^\circ\text{C}$; $I_f = 60\text{ mA}$)

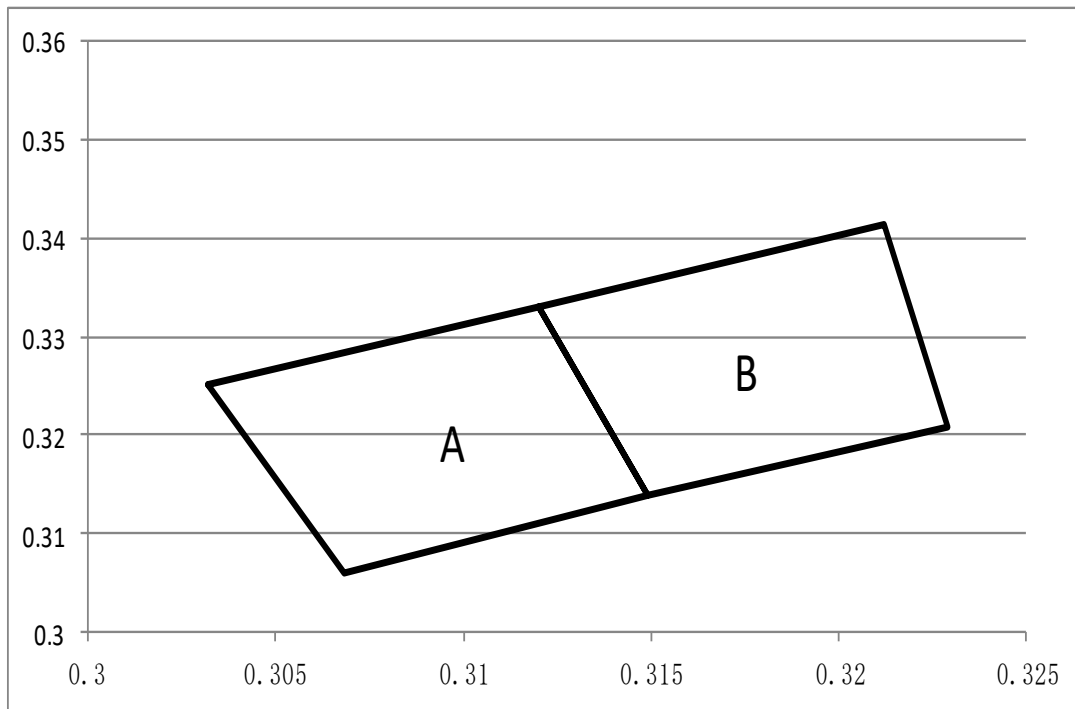

	X	Y		X	Y
A	0.3032	0.325	B	0.312	0.333
	0.312	0.333		0.3212	0.3414
	0.3149	0.3139		0.3229	0.3207
	0.3068	0.3059		0.3149	0.3139
	0.3032	0.325		0.312	0.333

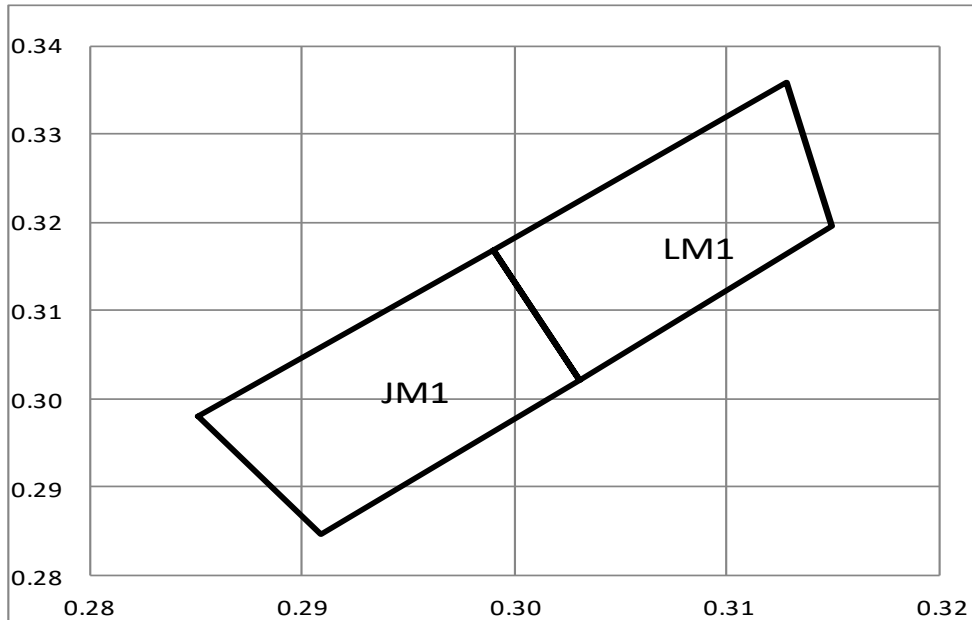
颜色色度分档3/Colour Chromaticity Groups 3 ($T_s = 25\text{ }^\circ\text{C}$; $I_f = 60\text{ mA}$)

	X	Y		X	Y
	0.2851	0.2980		0.2990	0.3169
JM1	0.2990	0.3169	LM1	0.3128	0.3359
	0.3031	0.3022		0.3150	0.3195
	0.2910	0.2846		0.3031	0.3022

标签信息 / Information on Label

例 / E. g. : CB-FK0-5

亮度档 / Brightness	颜色 / Color	正向电压 / Forward Voltage
CB	FK0	5

相对发射光谱 - $V(\lambda)$ = 标准人眼视觉曲线

Relative Spectral Emission - $V(\lambda)$ = Standard Eye Response Curve

$I_{rel} = f(\lambda)$; $T_s = 25\text{ }^\circ\text{C}$; $I_f = 60\text{ mA}$

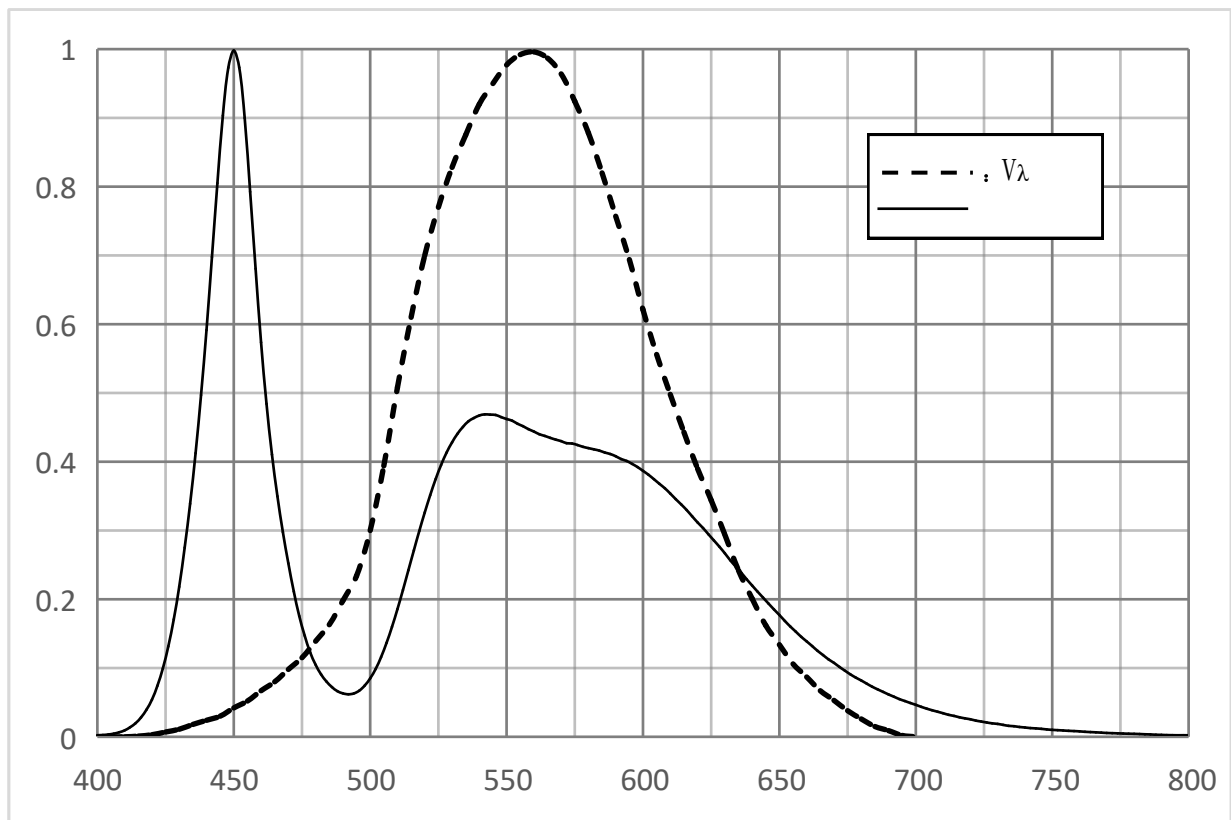

辐射特性 / Radiation Characteristics

$I_{rel} = f(\phi); T_s = 25\text{ }^\circ\text{C}$

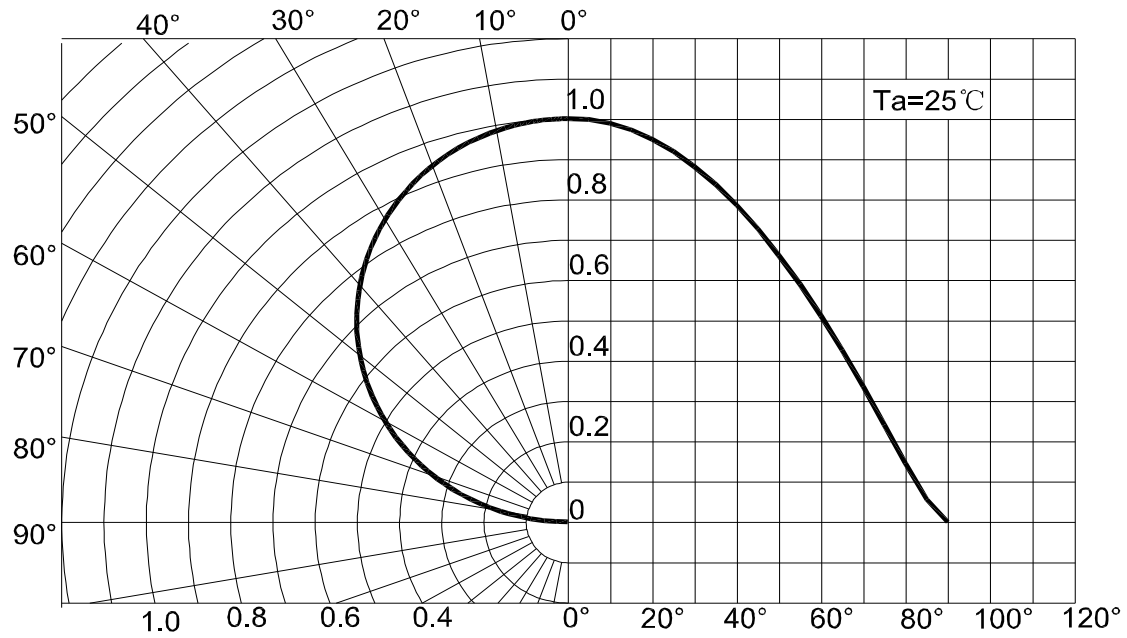

正向电流 / Forward Current

$I_f = f(V_f); T_a = 25\text{ }^\circ\text{C}$

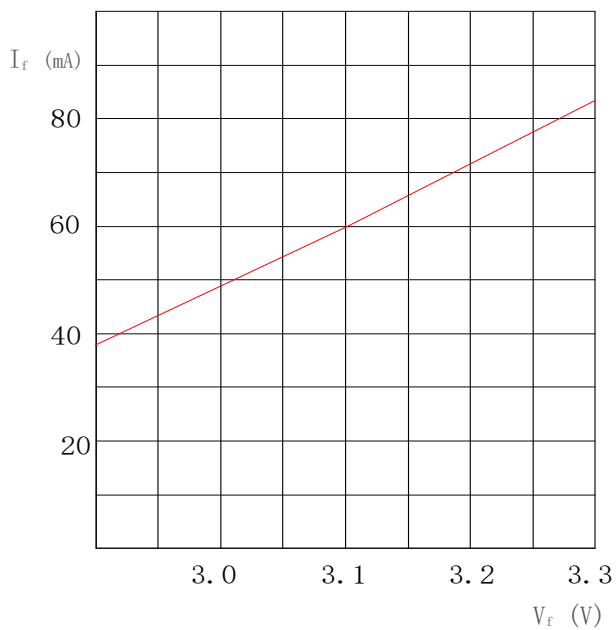

相对亮度特性曲线 / Relative Luminous Intensity

$I_v / I_v(60\text{ mA}) = f(I_f); T_a = 25\text{ }^\circ\text{C}$

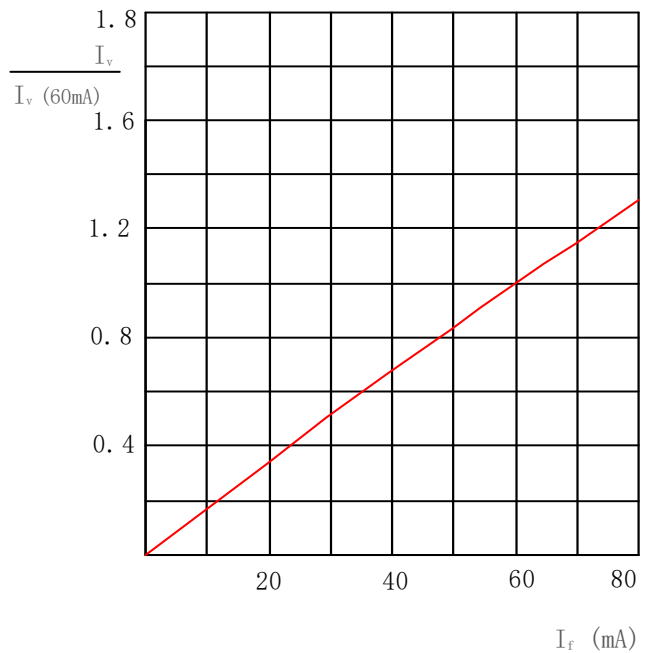

色坐标数据表/Chromaticity coordinate shift

$\Delta C_x, \Delta C_y = f(I_f); T_s = 25^\circ\text{C}$

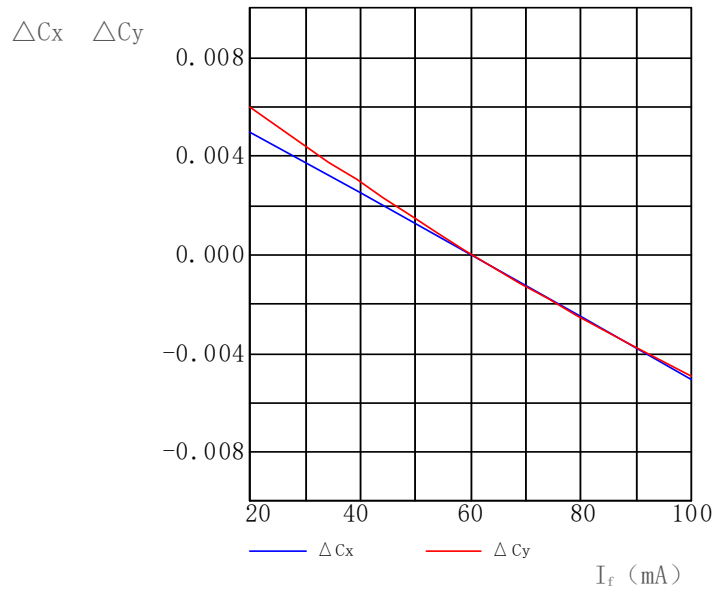

相对正向电压 / Relative Forward Voltage

$\Delta V_f = V_f - V_f(25^\circ\text{C}) = f(T_j); I_f = 60\text{ mA}$

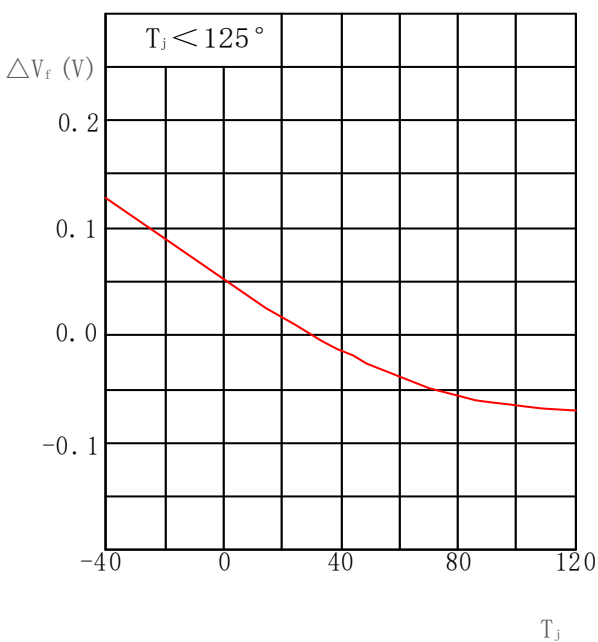

相对发光强度 / Relative Luminous Intensity

$I_v / I_v(25^\circ\text{C}) = f(T_j); I_f = 60\text{ mA}$

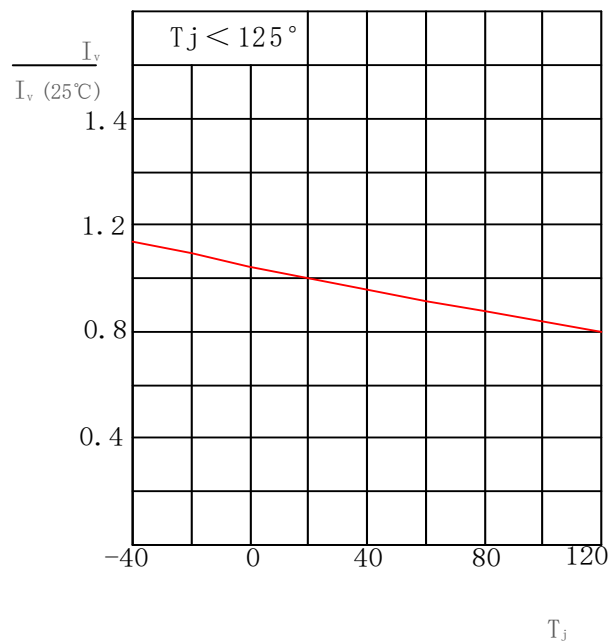

色坐标数据表/Chromaticity coordinate shift

$\Delta C_x, \Delta C_y = f(I_f); I_f = 60\text{mA}$

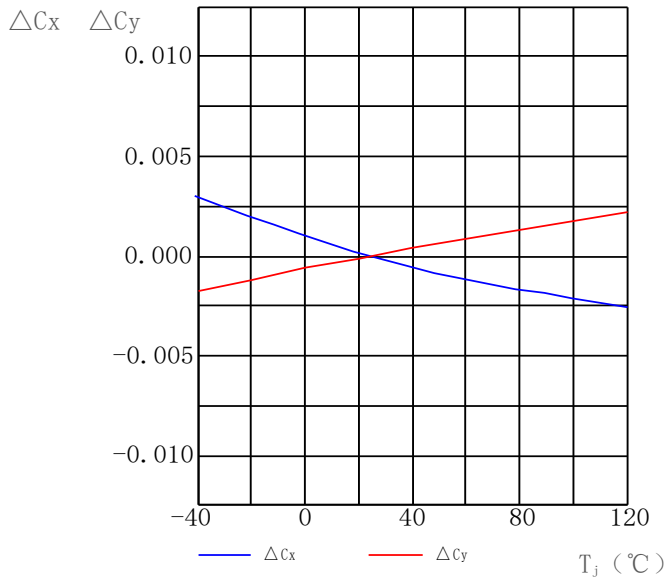

环境温度与正向电流

Ambient Temperature vs. Forward Current

$I_f = f(T_a)$

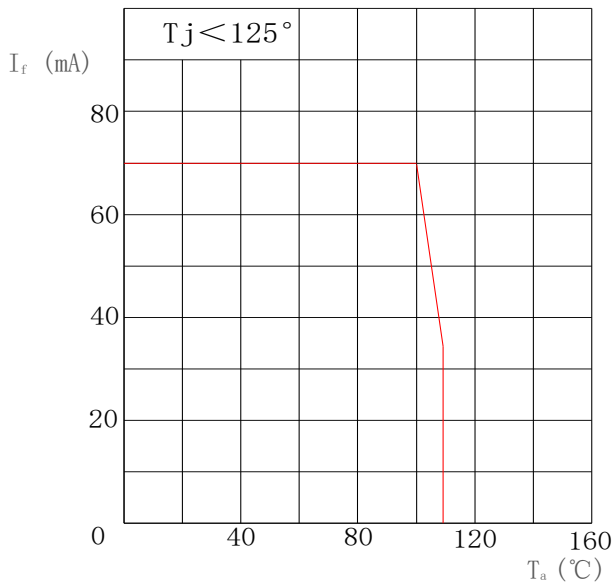

焊点温度与正向电流 / Solder Point Temperature vs. Forward Current

vs. Forward Current

$I_f = f(T_s)$

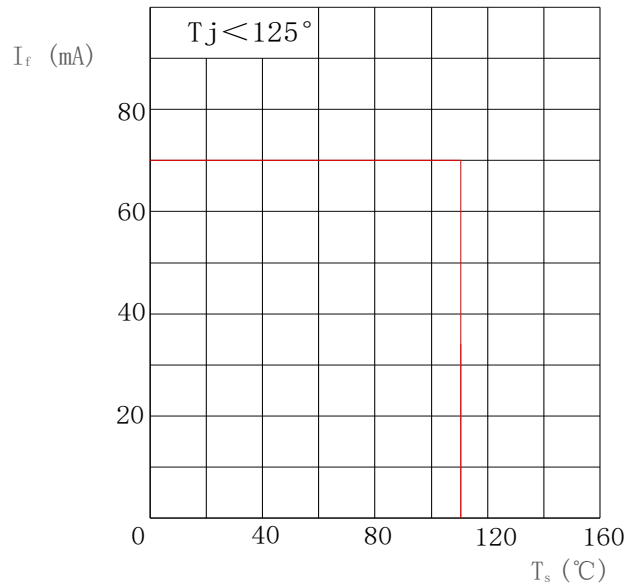

产品尺寸 / Package Outline

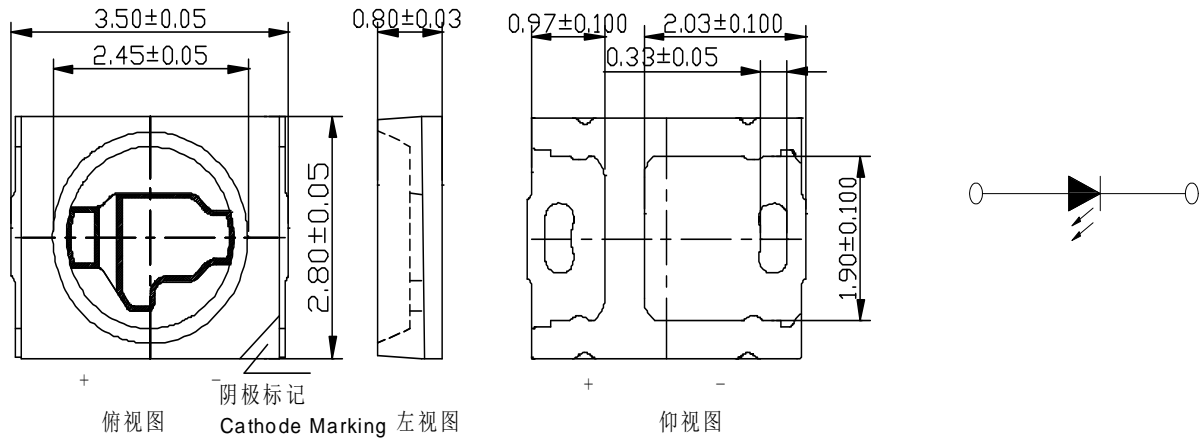

推荐焊盘 / Recommended Solder Pad

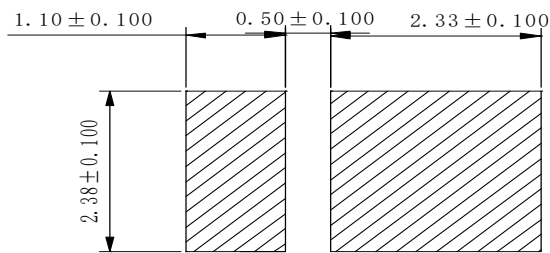

注释

■ 不适合超声波清洗的封装

NOTE

■ Package not suitable for ultrasonic cleaning

回流焊要求 / Reflow Soldering Profile

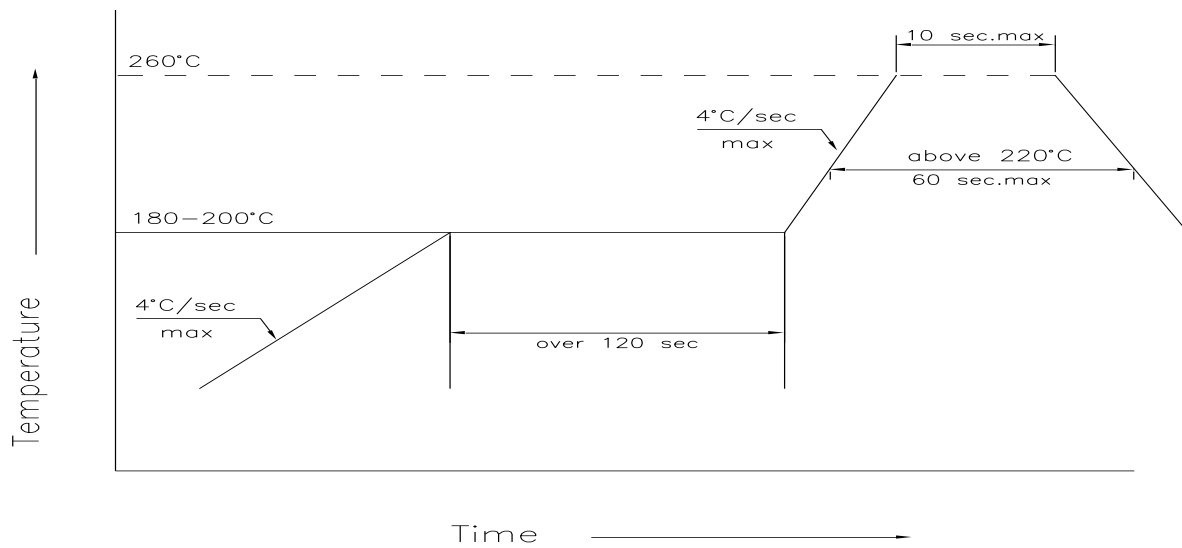

主要特性 Profile Feature	符号 Symbol	无铅焊接 Pb-Free Assembly			单位 Unit
		min.	rec.	max.	
预热升温速率 Ramp-up Rate to Preheat 25°C-180°C	-	-	2	3	°C/s
时间 / Time (T_{smin} to T_{smax})	T_s	60	100	120	s
峰值升温速率 Ramp-up Rate to Peak (T_{smax} to T_p)	-	-	2	3	°C/s
熔点温度 Liquidus Temperature	T_l		217		°C
高于熔点温度的时间 Time above Liquidus Temperature	t_l	-	80	100	s
峰值温度 / Peak Temperature	T_p	-	255	260	°C
规定的峰值温度±5°C以内的时间 Time within 5°C of the Specified Peak Temperature	t_p	10	20	30	s
降温速率 / Ramp-down Rate (T_p to 100°C)	-	-	3	6	°C/s
时间 / Time (25°C to T_p)	-	-	-	480	s

可靠性试验 / Reliability Test

试验项目 Test Item	试验方法Test Method	试验条件Test Condition	周期 Duration	试验数量 Number Of Test	试验结果 Test Result
光电测试 Test	产品规格书 Products Datasheet	25℃条件量测光电参数 Measurement of Photoelectric parameters At 25 °C	-	全部 ALL	Pass
外观检查 EV	JESD22 B-101	显微镜观察 OM observation	-	全部 ALL	Pass
参数验证 PV	产品规格书 Products Datasheet	25℃条件量测光电参数 Measurement of photoelectric pa- rameters at 25 °C	-	75	0/75
破坏性物理分 析 DPA	AEC-Q101-004	化学开盖后, 观察外观结构 After Decap, OM observation	-	10	0/10
人体模式静电 释放 ESD HBM	JESD22 A-114	±2000V	2次 2 times	30	0/30
机器模式静电 释放 ESD MM	JESD 22-A115C	±200V	2次 2 times	30	0/30
尺寸测量 PD	JESD22 B-100	参照样品种规格书 Per Products Datasheet	-	30	0/30
高温高湿通电 测试 WHTOL1	JESD22 A-101	Ta=85° C/85% RH, 开/关各30分 钟, If=350mA Ta=85°C 85%RH, 30min. on/30min. off, If=350mA	1000小时 1000 hours	78	0/78
功率温度循环 测试 PTC	JESD22 A-105	Ta = -40°C ~ 85°C, 驻留时间10分 钟, 转换时间11分钟, 开/关各5分 钟, If=350mA Ta=-40°C ~ 85°C, Dwell: 10min, Transition time: 11min, 5 min. on / 5 min. off, If=350mA	1000循环 1000 cyc	78	0/78
高温寿命测试 HTOL	JESD22-A108	Ta = 85° C, If=350mA	1000小时 1000 hours	78	0/78

可靠性试验 / Reliability Test

热阻测试 TR	JEDEC JESD51-50 JESD51-51 JESD51-52	需使用不同导热材质分层测试 Need to use different thermal conductivity material layer test	-	10	16
金线拉力 WBP	MIL-STD-750-2 Method 2037	参照MIL-STD-750-2Method 2037 Per MIL-STD-750-2Method 2037	-	15	Ppk>1.67
金球推力 WBS	AEC Q101-003	参照AEC Q101-003 Per AEC Q101-003	-	15	Ppk>1.67
晶片推力 DS	MIL-STD-750-2 Method 2017	参照MIL-STD-750-2Method 2017 Per MIL-STD-750-2Method 2017	-	15	Ppk>1.67

接受标准 / Acceptance Criteria

正向电压 Forward Voltage	Vf变化 \leq +/-10% VF shift% \leq +/- 10% from initial value
光通量 Luminous Flux	LM光通量变化 \leq +/-20%，备注：某些应用环境 \leq +/-30%，某些特定应用（如内饰） \leq +/-50% LM shift \leq % +/- 20% from initial value, Note. +/- 30% may be acceptable for some application. +/- 50% may be acceptable only for some application (e.g., interior).
色坐标Cx & Cy Colour coordinates Cx and Cy	Cx & Cy 变化 \leq +/-0.01, 备注：对于硫化氢和混合气体腐蚀的变化 \leq +/-0.02（如内饰） Cx & Cy shift \leq +/-0.01, Note: +/- 0.02 may be acceptable for H2S & FMG for some application (e.g., interior).
外观 Visual	无迁移，腐蚀，分层等 No migration, corrosion, delamination, other

卷带与卷盘 / Tape and Reel

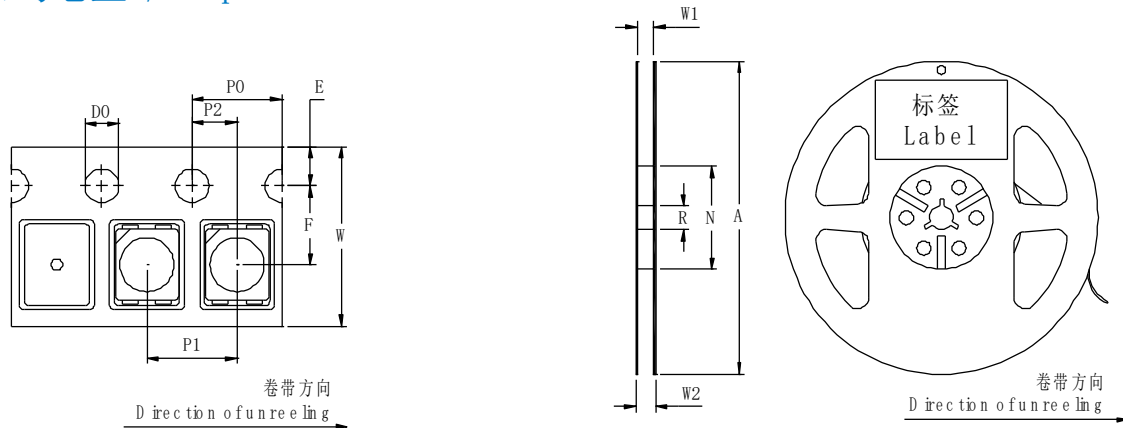

前端空带： 最小400 mm；尾端空带： 最小160 mm；尺寸符合： IEC 60286-3, EIA 481-D标准

Leader: min. 400 mm; Trailer: min. 160 mm; Requirement acc. to IEC 60286-3, EIA 481-D

卷带尺寸 / Tape Dimensions (mm)

W	P0	P1	P2	D0	E	F
8±0.1	4±0.1	4±0.1	2±0.05	1.50±0.05	1.75±0.1	3.50±0.05

卷盘尺寸 / Reel Dimensions (mm)

A	W1	W2	N	R
178.0±0.2	8.0±0.5	8.0±0.5	60.0±0.4	13.5±0.3

数量 (颗/卷) / Quantity (pcs/reel)

4000

条形码标签 / Barcode-Product-Label (BPL)

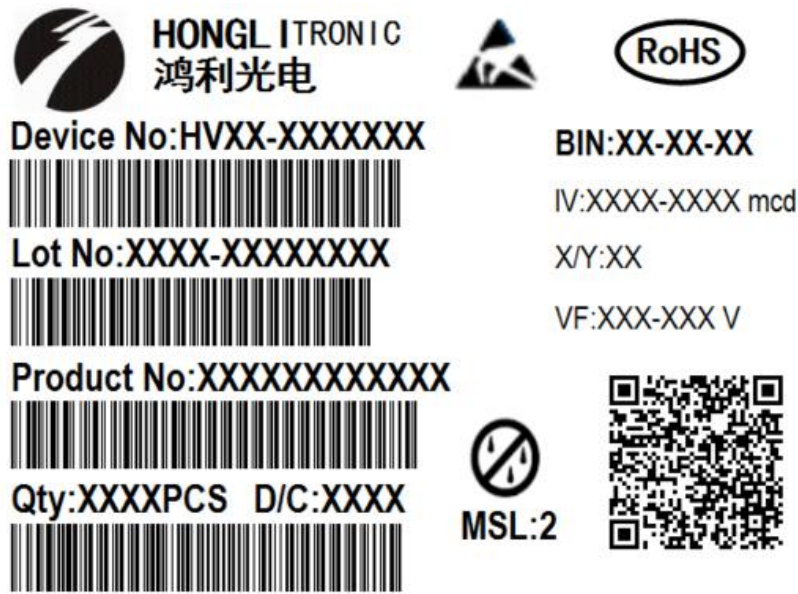

包装材料及过程 / Dry Packing Process and Materials

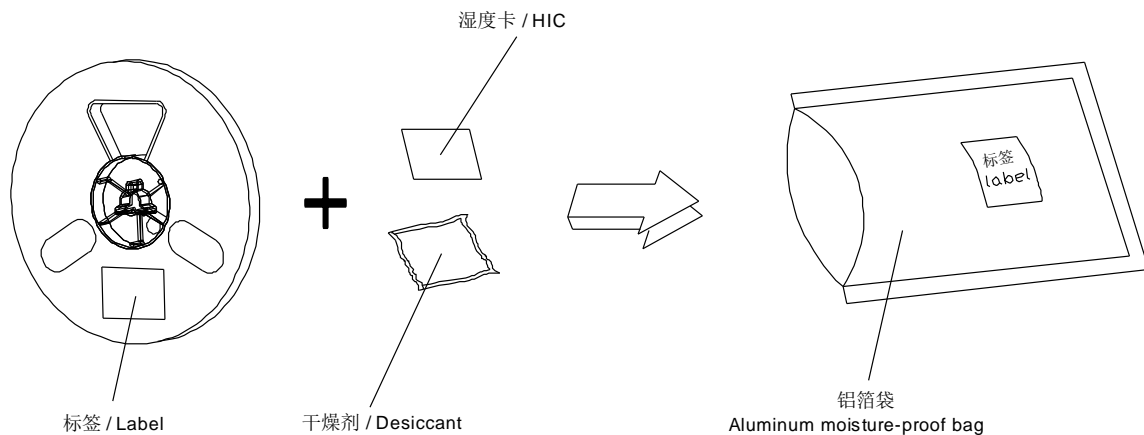

备注

产品包装在一个干燥的铝箔袋里，同时内附有干燥剂和湿度卡。
对于干燥包装，您可以从网络或JEDEC标准里获取。

NOTE

Moisture-sensitive product is packed in a dry bag containing desiccant and HIC (humidity indicator card).
Regarding dry pack you may find further information in the internet or JEDEC.

出货包装及材料 / Transportation Packing and Materials

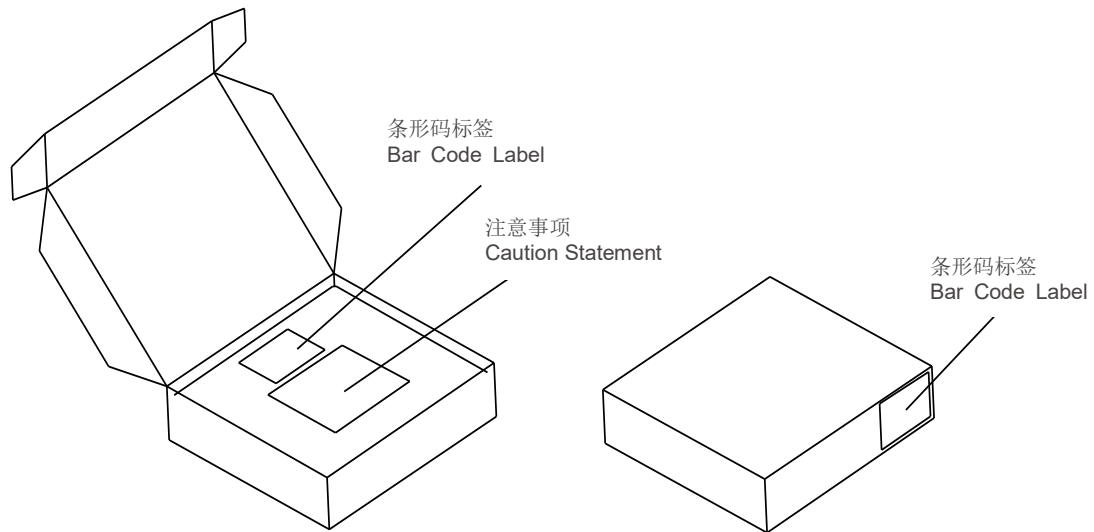

出货箱尺寸 / Dimensions of Transportation Box (mm)

宽度 / Width	长度 / Length	高度 / Height
256±5	223±5	62±5
256±5	223±5	124±5

注释

典型值： 每个产品的实际值可能与这些统计出的典型值不同。

公差： 除非图纸中有说明，公差默认为 ± 0.1 mm。

正向电压： 正向电压是在8ms脉冲电流并且内部在线性为 ± 0.05 V和一个 ± 0.1 V的外在不确定性（按照GUM K=3因子）来进行测试的。

波长： 波长是在25ms脉冲电流并且内部在线性为 ± 0.5 nm和一个 ± 1 nm的外在不确定性（按照GUM K=3因子）来进行测试的。

亮度： 亮度是在25ms脉冲电流并且内部在线性为 $\pm 8\%$ 和一个 $\pm 11\%$ 的外在不确定性（按照GUM K=3因子）来进行测试的。

特殊声明： 本版本最终解释权归属鸿利智汇，当中英文意思发生歧义时，以中文为准。

Glossary

Typical Values: Actual values of each product may differ from these statistical values .

Tolerance of Measure: Unless otherwise noted in drawing, tolerances are specified with +/-0.1mm.

Forward Voltage: The forward voltage is measured during a current pulse of typically 8 ms, with an internal reproducibility of ± 0.05 V and an expanded uncertainty of ± 0.1 V (acc. to GUM with a coverage factor of $k = 3$).

Wavelength: The wavelength is measured at a current pulse of typically 25 ms, with an internal reproducibility of ± 0.5 nm and an expanded uncertainty of ± 1 nm (acc. to GUM with a coverage factor of $k = 3$).

Brightness: Brightness values are measured during a current pulse of typically 25 ms, with an internal reproducibility of $\pm 8\%$ and an expanded uncertainty of $\pm 11\%$ (acc. to GUM with a coverage factor of $k = 3$).

Special Statement: The final interpretation of this specification shall be vested in Hongli-tronic, in the case of ambiguity, the Chinese version shall prevail.