

HVCB-3528CPX



3528 PLCC2 系列产品 / Products Series

具有高发光效率、高一致性、高稳定性、高可靠性，主要用于汽车应用

High luminous efficiency, consistency, stability and reliability, it is mainly used in automobile applications.

特征

- 外观：白色PPA塑料，有色硅树脂封装
- 50% I_v 视角：120°
- 颜色：Cx=0.20,Cy=0.30 (CIE1931)
- 资格：通过了AEC-Q102 & IEC 60810可靠性测试
- 潮湿敏感等级-2

Features

- Package: Colored silicon resin in white PPA cup
- Viewing angle at 50% I_v: 120°
- Color: Cx=0.20,Cy=0.30 (acc.to CIE1931)
- Qualifications: Passed reliability test per AEC-Q102 & IEC 60810 requirement
- MSL-2

应用

- 信号灯
- 汽车内外部照明应用

Applications

- Signaling
- Interior and exterior lighting for automotive

订购信息 / Ordering Information

型号 Type	发光强度 Luminous Intensity lv @ If=20mA	订购编号 Ordering Code
HVCB-3528CPX - XXXX - XXXX - XXXX 亮度档 颜色档 电压档 Brightness Color Forward Voltage	1120 - 2400 mcd	XXXXXX

备注

■ 亮度档

单个最小包装只装有同一个亮度档次的产品，具体分档信息请见第4页

例如：HVCB-3528CPX-AXBY-XX-XXXX，单个卷盘中的产品只有AX、AY、AZ、BX、BY中的某一档

■ 颜色档

单个最小包装只装有同一个颜色档次的产品，具体分档信息请见第5页

例如：HVCB-3528CPX-XXXX-2N8J-XXXX，单个卷盘中的产品只有2N、2J、2K、2L、3J、3K、3L……8J中的某一档

■ 正向电压档

单个最小包装只装有同一个正向电压档次的产品，具体分档信息请见第4页

例如：HVCB-3528CPX-XXXX-XX-5B6B，单个卷盘中的产品只有5B、6A、6B中的某一档

Note

■ Brightness Grouping

Only one brightness group will be packed in one reel. Please refer to page #4 for details.

E.g.: HVCB-3528CPX-AXBY-XX-XXXX, means only one bin of AX、AY、AZ、BX or BY is in one reel.

■ Color Groups

Only one color group will be packed in one reel. Please refer to page #5 for details.

E.g.: HVCB-3528CPX-XXXX-2N8J-XXXX, means only one bin of 2N、2J、2K、2L、3J、3K、3L……8J is in one reel.

■ Forward Voltage Groups

Only one forward voltage group will be packed in one reel. Please refer to page #4 for details.

E.g.: HVCB-3528CPX-XXXX-XX-5B6B, means only one bin of 5B、6A、6B is in one reel.

极限参数 / Maximum Ratings

参数 Parameters	符号 Symbol	数值 Rating	单位 Unit
结温 / Junction Temperature	T_j	125	°C
正向电流 / Forward Current ($T_s=25^\circ\text{C}$)	I_f	90	mA
峰值正向电流 Peak Forward Current ($t \leq 10\mu\text{s}$; $D=0.005$; $T_s=25^\circ\text{C}$)	I_{fp}	200	mA
反向电压 / Reverse Voltage ($T_s=25^\circ\text{C}$)	V_r	不适用于反向操作 Not designed for reverse operation	V
抗静电能力 Electrostatic Discharge (HBM)	V_{ESD}	8000	V
操作温度 / Operating Temperature	T_{opr}	-40 ~ +110	°C
储存温度 / Storage Temperature	T_{stg}	-40 ~ +110	°C

特性 / Characteristics ($T_s = 25^\circ\text{C}$; $I_f = 20\text{ mA}$)

参数 Parameters	符号 Symbol	数值 Rating	单位 Unit
色坐标 / Chromaticity coordinates acc. to CIE 1931	typ. C_x	0.20	-
	C_y	0.30	-
50 % I_v 下的视角 / Viewing Angle at 50 % I_v	typ. 2Φ	120	°
	min. V_f	2.70	V
	typ. V_f	2.90	V
正向电压 / Forward Voltage	max V_f	3.40	V
	typ. R_{thJS}	135	°C/W
Real thermal resistance junction/ solder-point			

亮度分档 / Brightness Grouping ($T_s = 25\text{ }^\circ\text{C}$; $I_f = 20\text{ mA}$)

档次 Grouping	发光强度 Luminous Intensity I_v (min.)	发光强度 Luminous Intensity I_v (max.)	光通量 Luminous Flux Φ_v (typ.)
AX	1120 mcd	1300 mcd	3.80 lm
AY	1300 mcd	1500 mcd	4.30 lm
AZ	1500 mcd	1800 mcd	5.20 lm
BX	1800 mcd	2100 mcd	6.10 lm
BY	2100 mcd	2400 mcd	6.80 lm

正向电压分档 / Forward Voltage Grouping ($T_s = 25\text{ }^\circ\text{C}$; $I_f = 20\text{ mA}$)

档次 Grouping	正向电压 Forward Voltage V_f (min.)	正向电压 Forward Voltage V_f (max.)
5A	2.50 V	2.70 V
5B	2.70 V	2.90 V
6A	2.90 V	3.10 V
6B	3.10 V	3.40 V

颜色色度分档/Colour Chromaticity Groups ($T_s = 25\text{ }^\circ\text{C}$; $I_f = 20\text{ mA}$)

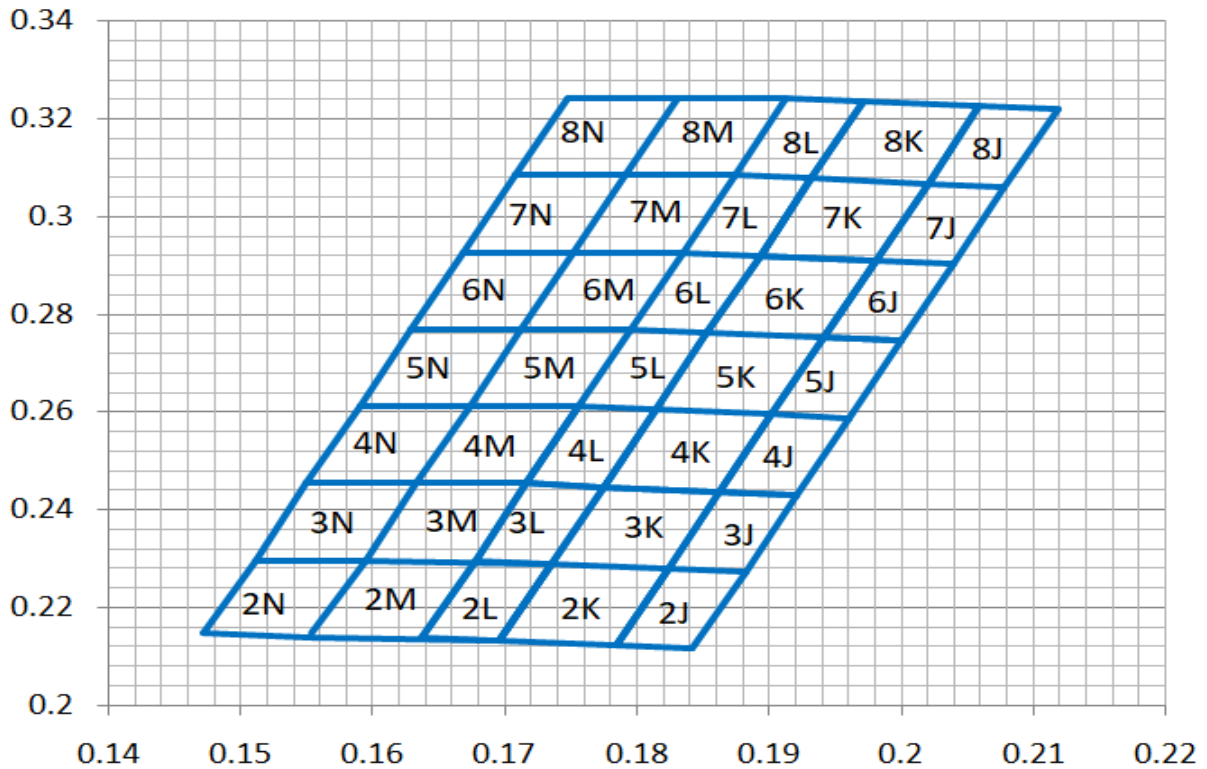

2J	0.1823	0.228	3J	0.1862	0.2437	4J	0.1902	0.2595
	0.1882	0.2273		0.1921	0.2431		0.1960	0.2588
	0.1842	0.2116		0.1882	0.2273		0.1921	0.2431
	0.1784	0.2122		0.1823	0.228		0.1862	0.2437
2K	0.1735	0.2290	3K	0.1775	0.2447	4K	0.1814	0.2605
	0.1823	0.2280		0.1862	0.2437		0.1902	0.2595
	0.1784	0.2122		0.1823	0.2280		0.1862	0.2437
	0.1696	0.2132		0.1735	0.2290		0.1775	0.2447
2L	0.1677	0.2296	3L	0.1716	0.2454	4L	0.1756	0.2611
	0.1735	0.229		0.1775	0.2447		0.1814	0.2605
	0.1696	0.2132		0.1735	0.2290		0.1775	0.2447
	0.1637	0.2139		0.1677	0.2296		0.1716	0.2454
2M	0.1554	0.2139	3M	0.1594	0.2296	4M	0.1633	0.2454
	0.1594	0.2296		0.1633	0.2454		0.1673	0.2611
	0.1677	0.2296		0.1716	0.2454		0.1756	0.2611
	0.1637	0.2139		0.1677	0.2296		0.1716	0.2454
2N	0.1471	0.2139	3N	0.1511	0.2296	4N	0.1550	0.2454
	0.1511	0.2296		0.1550	0.2454		0.1590	0.2611
	0.1594	0.2296		0.1633	0.2454		0.1673	0.2611
	0.1554	0.2139		0.1594	0.2296		0.1633	0.2454

5J	0.1941	0.2753	6J	0.198	0.291	7J	0.202	0.3068
	0.2000	0.2746		0.2039	0.2904		0.2078	0.3061
	0.1960	0.2588		0.2000	0.2746		0.2039	0.2904
	0.1902	0.2595		0.1941	0.2753		0.1980	0.291
5K	0.1853	0.2762	6K	0.1893	0.292	7K	0.1932	0.3078
	0.1941	0.2753		0.1980	0.2910		0.2020	0.3068
	0.1902	0.2595		0.1941	0.2753		0.1980	0.291
	0.1814	0.2605		0.1853	0.2762		0.1893	0.292
5L	0.1795	0.2769	6L	0.1834	0.2926	7L	0.1874	0.3084
	0.1853	0.2762		0.1893	0.292		0.1932	0.3078
	0.1814	0.2605		0.1853	0.2762		0.1893	0.292
	0.1756	0.2611		0.1795	0.2769		0.1834	0.2926
5M	0.1673	0.2611	6M	0.1712	0.2769	7M	0.1751	0.2926
	0.1712	0.2769		0.1751	0.2926		0.1791	0.3084
	0.1795	0.2769		0.1834	0.2926		0.1874	0.3084
	0.1756	0.2611		0.1795	0.2769		0.1834	0.2926
5N	0.1590	0.2611	6N	0.1629	0.2769	7N	0.1668	0.2926
	0.1629	0.2769		0.1668	0.2926		0.1708	0.3084
	0.1712	0.2769		0.1751	0.2926		0.1791	0.3084
	0.1673	0.2611		0.1712	0.2769		0.1751	0.2926
8J	0.2059	0.3225	8K	0.1971	0.3235	8L	0.1913	0.3242
	0.2118	0.3219		0.2059	0.3225		0.1971	0.3235
	0.2078	0.3061		0.2020	0.3068		0.1932	0.3078
	0.2020	0.3068		0.1932	0.3078		0.1874	0.3084
8M	0.1791	0.3084	8N	0.1708	0.3084			
	0.1830	0.3242		0.1747	0.3242			
	0.1913	0.3242		0.1830	0.3242			
	0.1874	0.3084		0.1791	0.3084			

标签信息 / Information on Label

例 / E.g.: BX-5J-6A

亮度档 / Brightness	颜色 / Color	正向电压 / Forward Voltage
BX	5J	6A

相对发射光谱 - $V(\lambda)$ = 标准人眼视觉曲线

Relative Spectral Emission - $V(\lambda)$ = Standard Eye Response Curve

$I_{rel} = f(\lambda)$; $T_s = 25\text{ }^\circ\text{C}$; $I_f = 20\text{mA}$

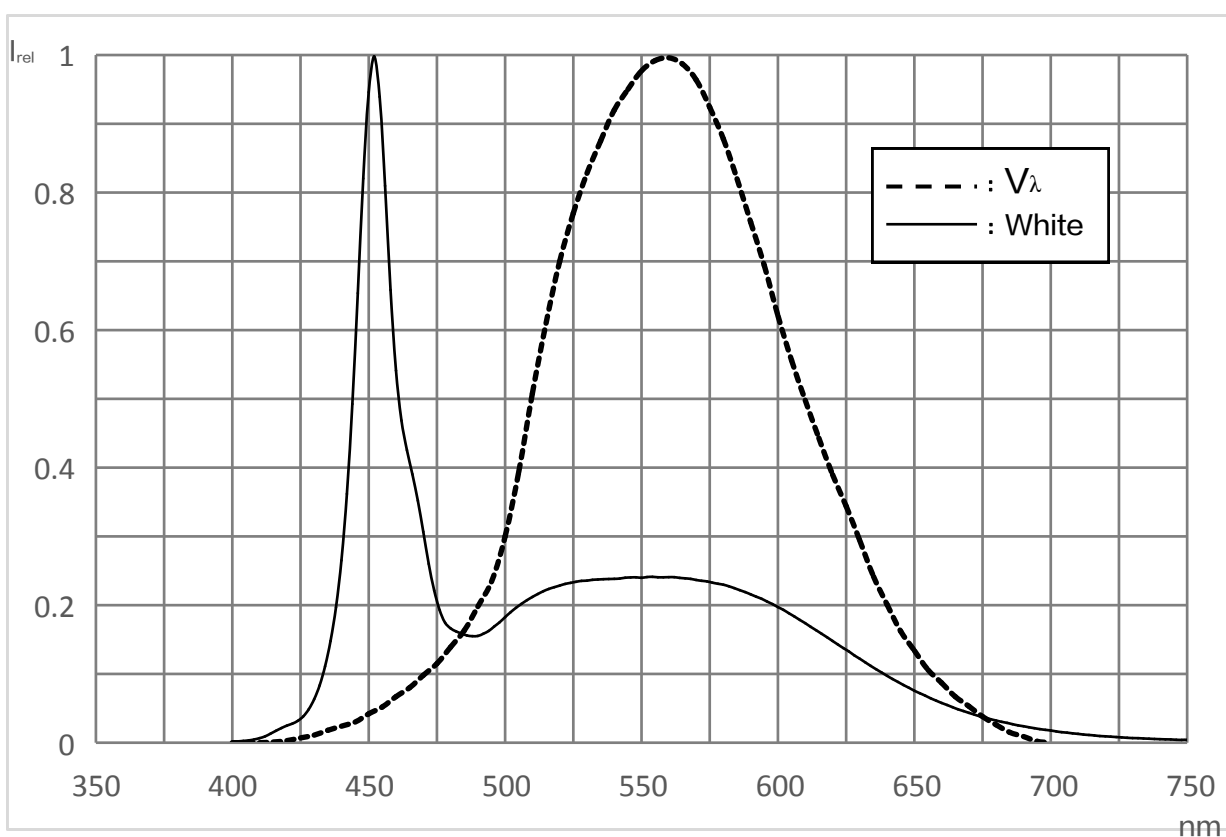

辐射特性 / Radiation Characteristics

$I_{rel} = f(\phi); T_s = 25^\circ\text{C}$

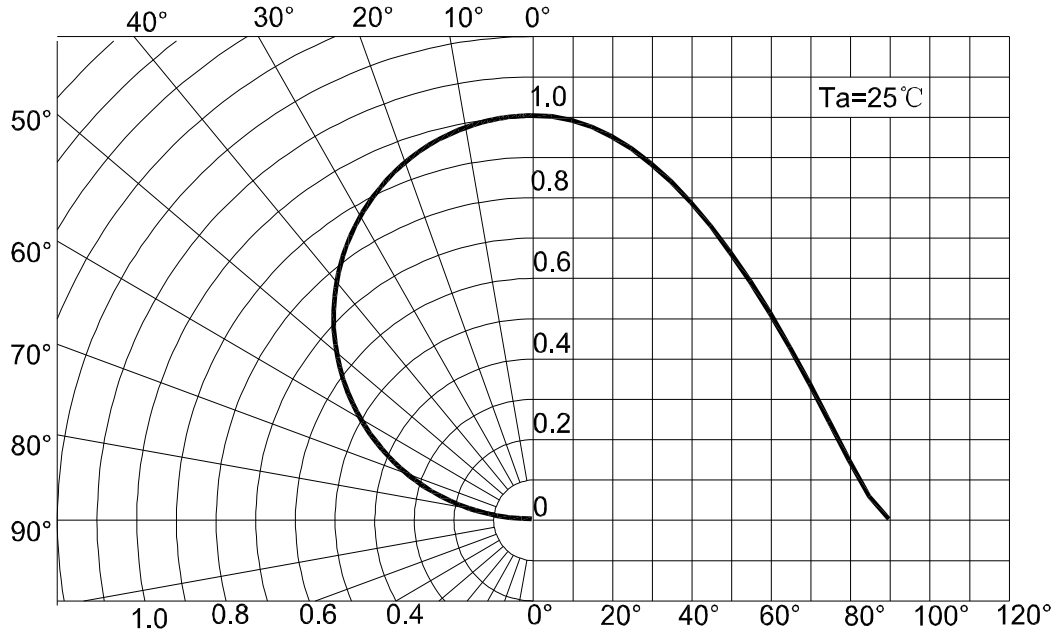

正向电流 / Forward Current

$I_f = f(V_f); T_a = 25^\circ\text{C}$

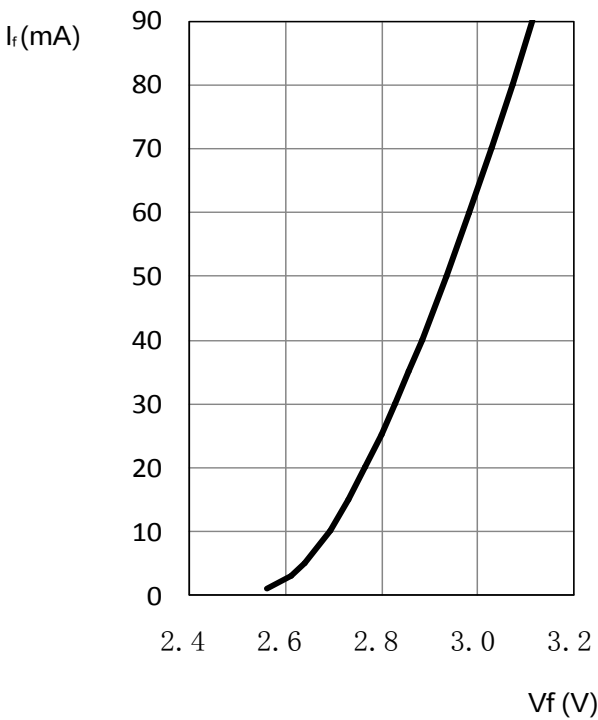

相对亮度特性曲线 / Relative Luminous Intensity

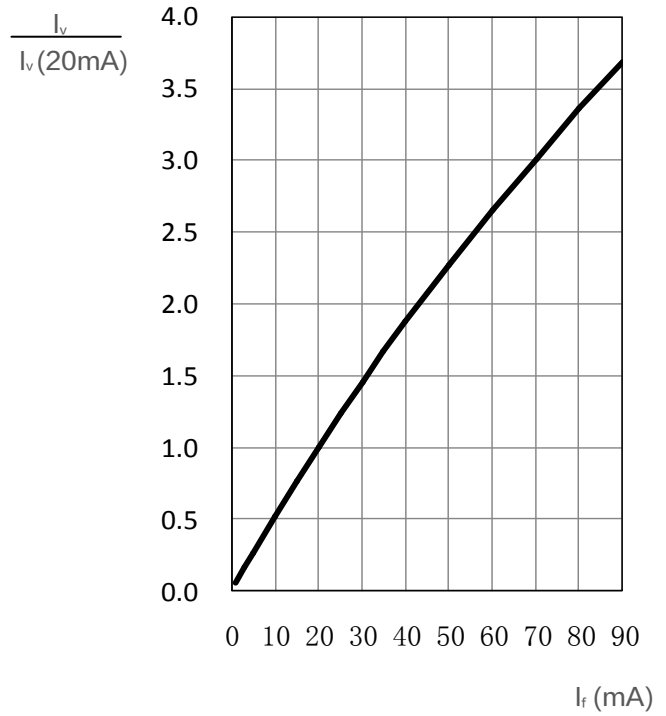

色坐标数据表/Chromaticity coordinate shift
 $\Delta C_x, \Delta C_y = f(I_f); T_s = 25^\circ\text{C}$

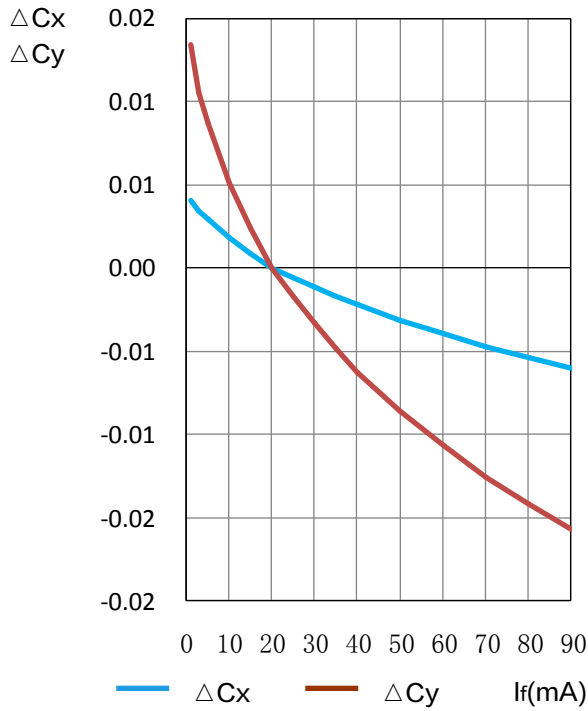

色坐标数据表/Chromaticity coordinate shift
 $\Delta C_x, \Delta C_y = f(I_f); I_f = 20\text{mA}$

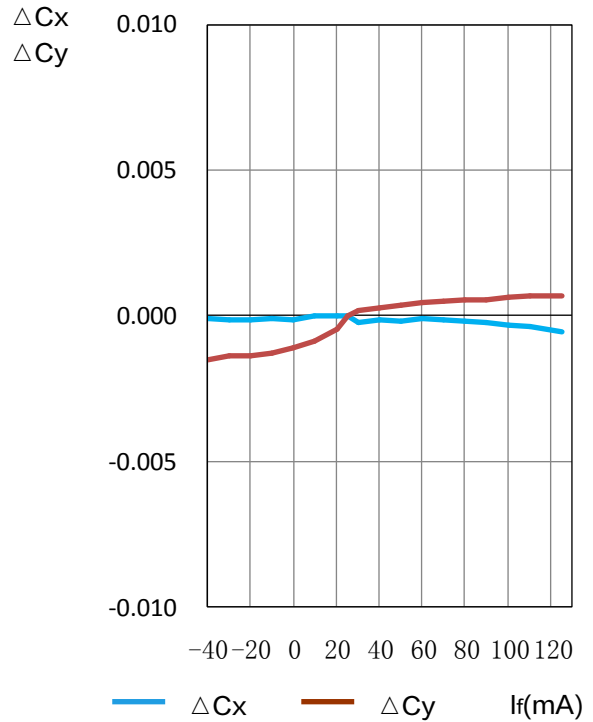

相对正向电压 / Relative Forward Voltage
 $\Delta V_f = V_f - V_f(25^\circ\text{C}) = f(T_j); I_f = 20\text{mA}$

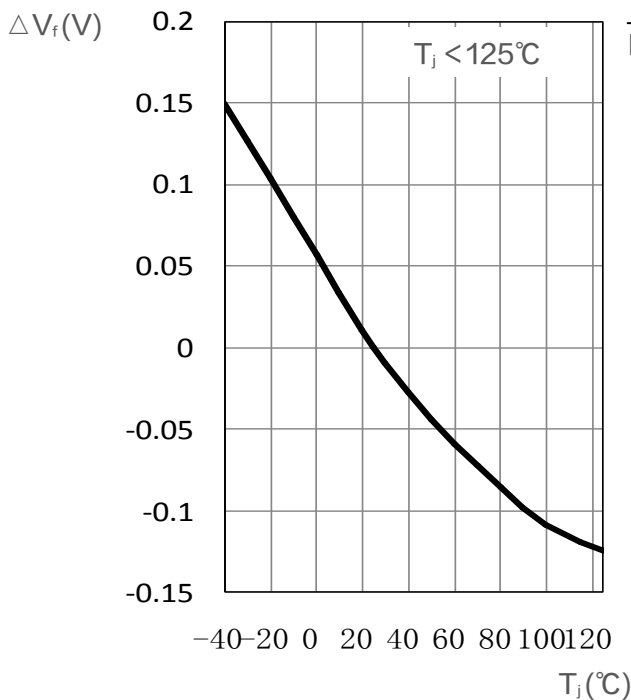

相对发光强度 / Relative Luminous Intensity
 $I_v / I_v(25^\circ\text{C}) = f(T_j); I_f = 20\text{mA}$

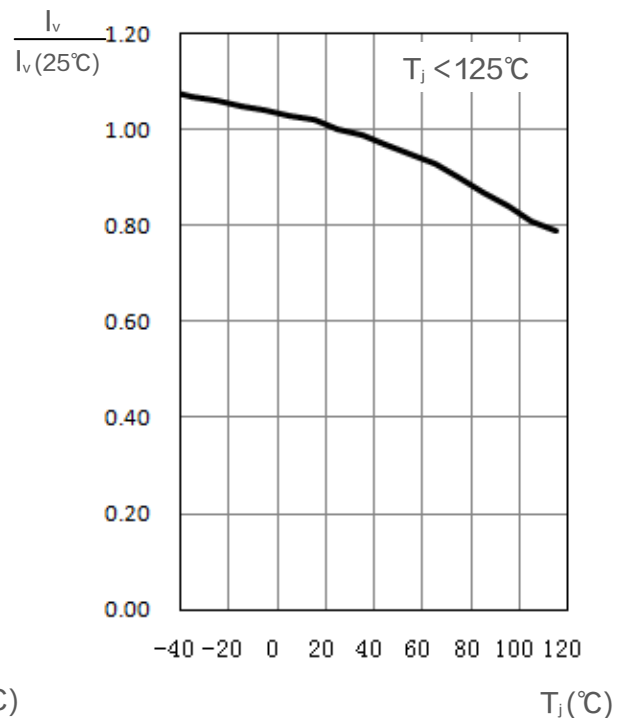

环境温度与正向电流

Ambient Temperature vs. Forward Current

$I_f = f(T_a)$

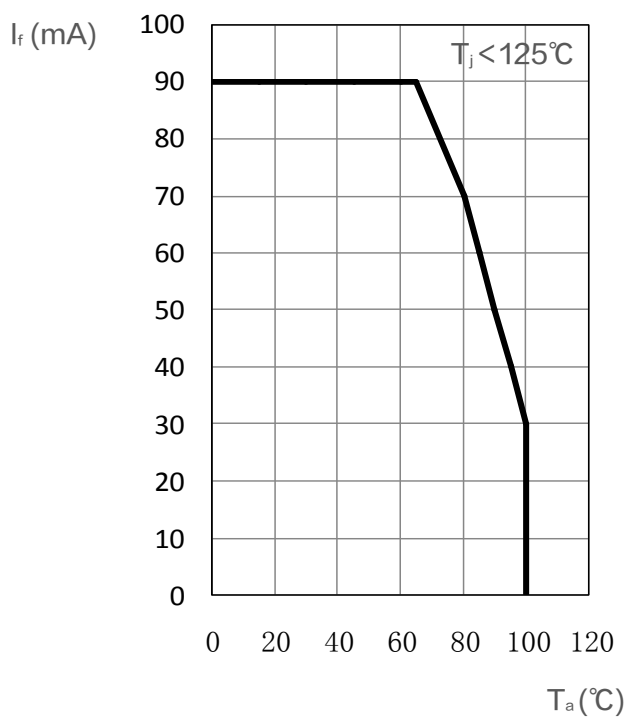

焊点温度与正向电流 / Solder Point Temperature vs. Forward Current

vs. Forward Current

$I_f = f(T_s)$

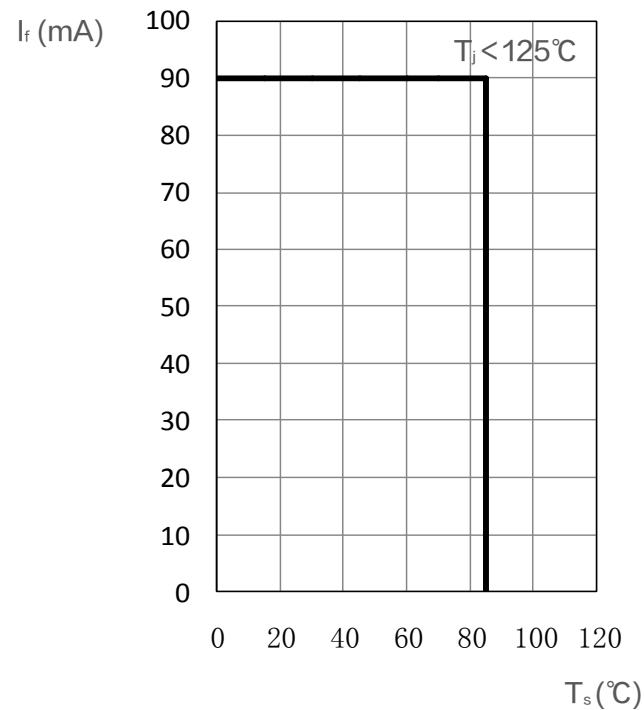

产品尺寸 / Package Outline

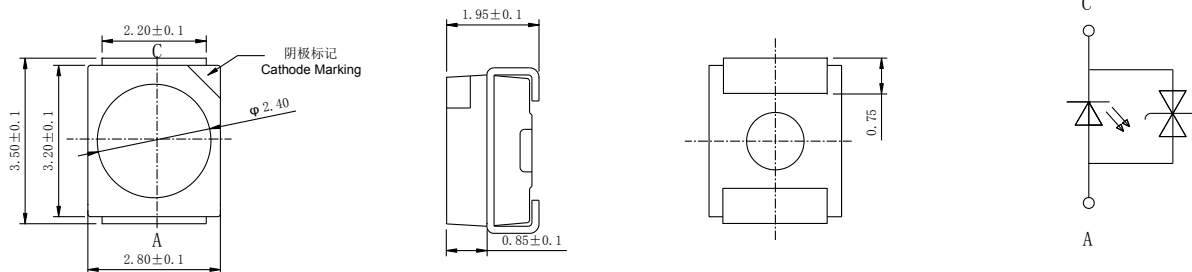

备注

■ 统计质量: 30mg

■ 标 记: 负极

NOTE

■ Approximate Weight: 30mg

■ Mark: Cathode

推荐焊盘 / Recommended Solder Pad

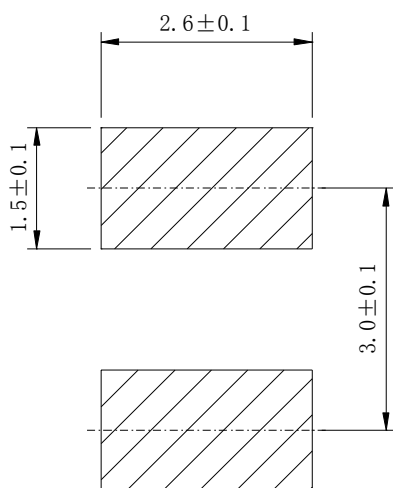

注释

■ 不适合超声波清洗的封装

NOTE

■ Package not suitable for ultrasonic cleaning

回流焊要求 / Reflow Soldering Profile

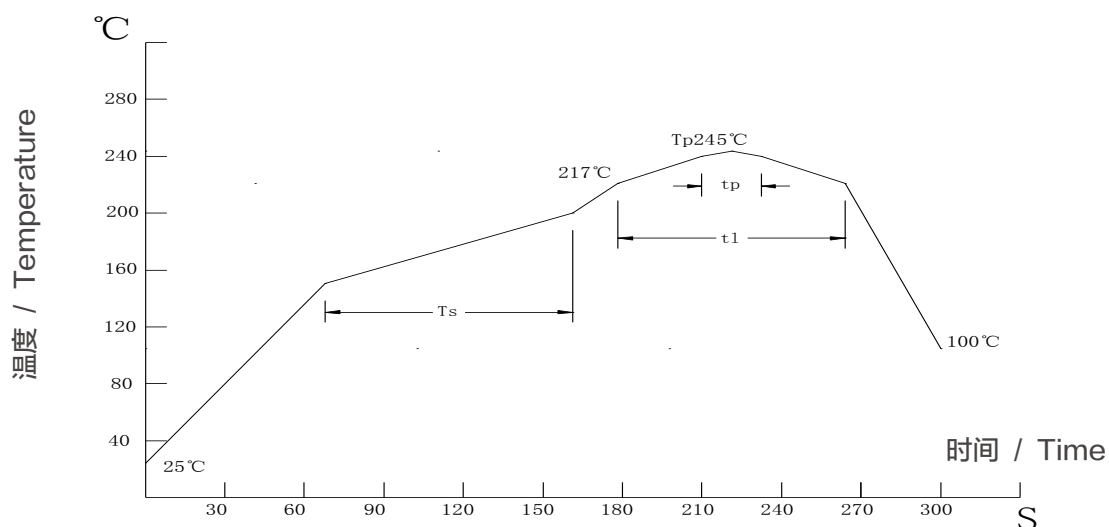

主要特性 Profile Feature	符号 Symbol	无铅焊接 Pb-Free Assembly			单位 Unit
		min.	rec.	max.	
预热升温速率 Ramp-up Rate to Preheat 25°C-150°C	-	-	2	3	°C/s
时间 / Time (T_{smin} to T_{smax})	T_s	60	100	120	s
峰值升温速率 Ramp-up Rate to Peak (T_{smax} to T_p)	-	-	2	3	°C/s
熔点温度 Liquidus Temperature	T_l		217		°C
高于熔点温度的时间 Time above Liquidus Temperature	t_l	-	80	100	s
峰值温度 / Peak Temperature	T_p	-	245	260	°C
规定的峰值温度 $\pm 5^\circ\text{C}$ 以内的时间 Time within 5°C of the Specified Peak Temperature	t_p	10	20	30	s
降温速率 / Ramp-down Rate (T_p to 100°C)	-	-	3	6	°C/s
时间 / Time (25°C to T_p)	-	-	-	480	s

卷带与卷盘 / Tape and Reel

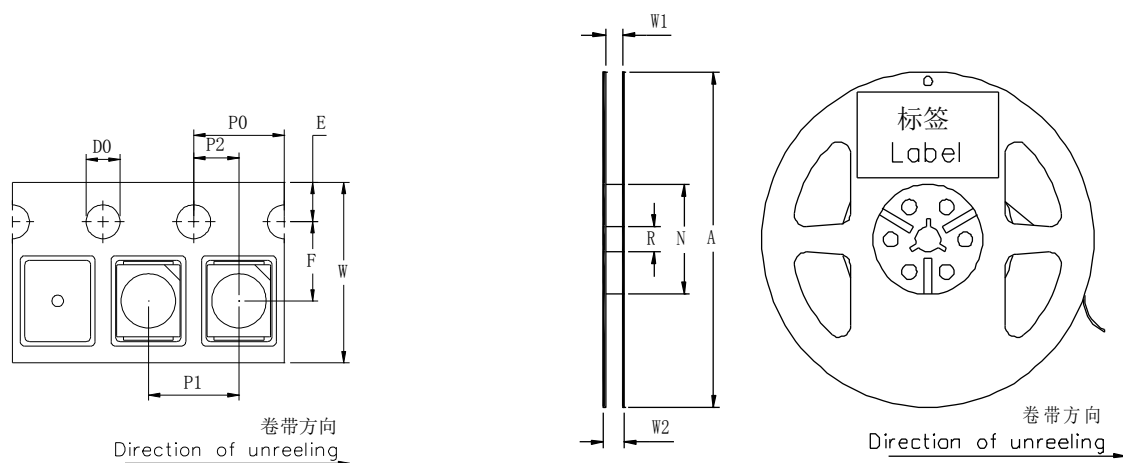

前端空带: 最小400 mm; 尾端空带: 最小160 mm; 尺寸符合: IEC 60286-3, EIA 481-D标准
 Leader: min. 400 mm; Trailer: min. 160 mm; Requirement acc. to IEC 60286-3, EIA

卷带尺寸 / Tape Dimensions (mm)

W	P0	P1	P2	D0	E	F
8±0.1	4±0.1	4±0.1	2±0.05	1.5±0.1	1.75±0.1	3.5±0.05

卷盘尺寸 / Reel Dimensions (mm)

A	W1	W2	N	R
177.8	9.3±0.3	11.2±0.3	58.5±0.2	13.5±0.2

数量 (颗/卷) / Quantity (pcs/reel)

2000

条形码标签 / Barcode-Product-Label (BPL)



包装材料及过程 / Dry Packing Process and Materials

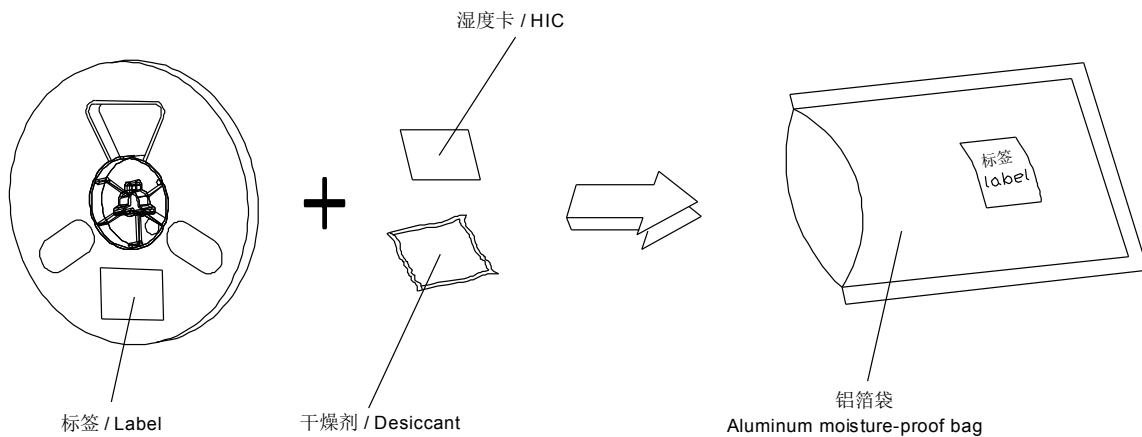

备注

产品包装在一个干燥的铝箔袋里，同时内附有干燥剂和湿度卡。
对于干燥包装，您可以从网络或JEDEC标准里获取。

NOTE

Moisture-sensitive product is packed in a dry bag containing desiccant and HIC (humidity indicator card).
Regarding dry pack you may find further information in the internet or JEDEC.

出货包装及材料 / Transportation Packing and Materials

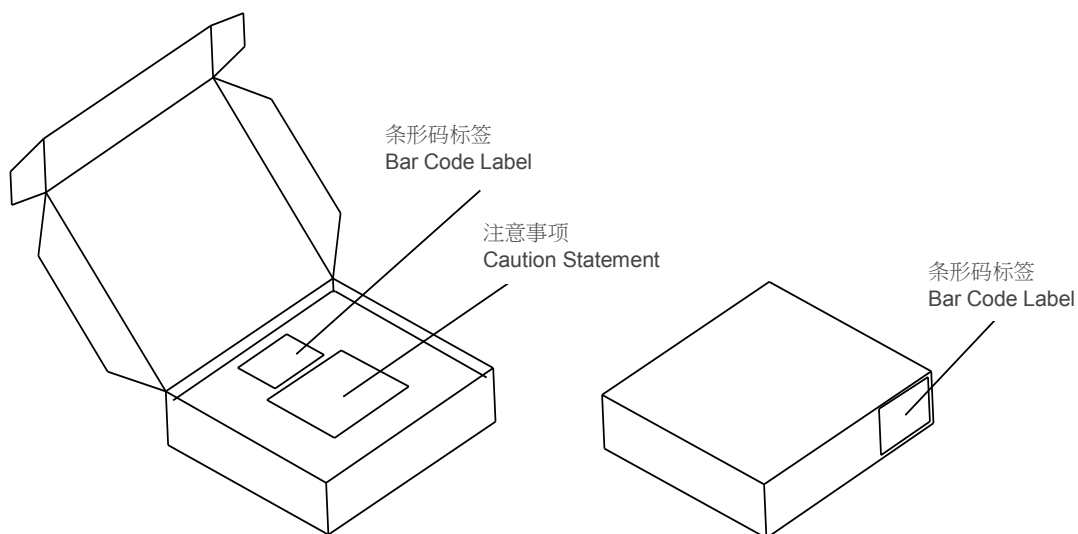

出货箱尺寸 / Dimensions of Transportation Box (mm)

宽度 / Width	长度 / Length	高度 / Height
256 ± 5	223 ± 5	62 ± 5
256 ± 5	223 ± 5	124 ± 5

注释

典型值: 每个产品的实际值可能与这些统计出的典型值不同。

公差: 除非图纸中有说明, 公差默认为 ± 0.1 mm。

正向电压: 正向电压是在8ms脉冲电流并且内部在线性为 ± 0.05 V和一个 ± 0.1 V的外在不确定性 (按照GUM K=3因子) 来进行测试的。

色度坐标: 色度坐标是在25ms脉冲电流并且内部在线性为 ± 0.005 和一个 ± 0.01 的外在不确定性 (按照GUM K=3因子) 来进行测试的。

亮度: 亮度是在25ms脉冲电流并且内部在线性为 $\pm 8\%$ 和一个 $\pm 11\%$ 的外在不确定性 (按照GUM K=3因子) 来进行测试的。

特殊声明: 本版本最终解释权归属鸿利智汇, 当中英文意思发生歧义时, 以中文为准。

Glossary

Typical Values: Actual values of each product may differ from these statistical values .

Tolerance of Measure: Unless otherwise noted in drawing, tolerances are specified with $+/-0.1$ mm.

Forward Voltage: The forward voltage is measured during a current pulse of typically 8 ms, with an internal reproducibility of ± 0.05 V and an expanded uncertainty of ± 0.1 V (acc. to GUM with a coverage factor of $k = 3$).

Chromaticity coordinate groups: Chromaticity coordinate groups is measured at a current pulse of typically 25 ms, with an internal reproducibility of ± 0.005 and an expanded uncertainty of ± 0.01 (acc. to GUM with a coverage factor of $k = 3$).

Brightness: Brightness values are measured during a current pulse of typically 25 ms, with an internal reproducibility of $\pm 8\%$ and an expanded uncertainty of $\pm 11\%$ (acc. to GUM with a coverage factor of $k = 3$).

Special Statement: The final interpretation of this specification shall be vested in Honglitronic, in the case of ambiguity, the Chinese version shall prevail.