

DESCRIPTION:

TVS diodes can be used in a wide range of applications which like consumer electronic products, automotive industries, munitions, telecommunications, aerospace industries, and intelligent control systems.

FEATURES:

- ✧ Low profile package.
- ✧ Low inductance.
- ✧ Excellent clamping capability.
- ✧ 200W peak pulse power capability at 10×1000μs waveform.
- ✧ Typical I_R less than 1μA above 10V.
- ✧ Fast response time: typically less than 1.0ps from 0V to V_{BR} min.
- ✧ High temperature reflow soldering: 260°C/40s at terminals.
- ✧ Plastic package has underwriters laboratory flammability 94V-0.
- ✧ Meets MSL level 1, per J-STD020, LF maximum peak of 260°C.
- ✧ For surface mounted applications in order to optimize board space.

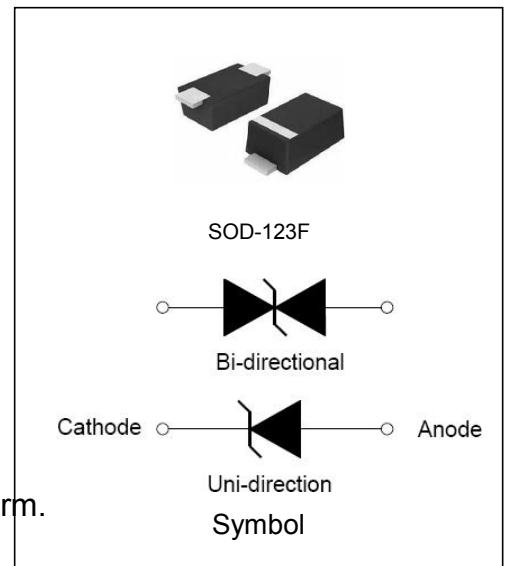

ABSOLUTE MAXIMUM RATINGS (TA=25°C, RH=45%-75%, unless otherwise noted)

Parameter	Symbol	Value	Unit
Storage and operating junction temperature range	T_{STG}/T_J	-55 to +150	°C
Steady state power dissipation at $T_L=75^\circ\text{C}$	$P_{M(AV)}$	2.8	W
Peak pulse power dissipation on 10/1000μs waveform	P_{PP}	200	W
Maximum instantaneous forward voltage at 20A for unidirectional	V_F	3.5	V
Typical thermal resistance junction to lead	$R_{\theta JL}$	100	°C/W
Typical thermal resistance junction to ambient	$R_{\theta JA}$	220	°C/W

MARKING



KE : Device Marking Code

ELECTRICAL CHARACTERISTICS (TA=25°C)

Part Number		Marking		V _R	I _R @ V _R	V _{BR} @I _T		I _T	V _C @I _{PP}	I _{PP} ①
Uni-Polar	Bi-Polar	Uni	Bi	V	μA	min(V)	max(V)	mA	max(V)	A
SMF5.0A	SMF5.0CA	KE	5C	5.0	400	6.40	7.00	10	9.2	21.7
SMF6.0A	SMF6.0CA	KG	6C	6.0	400	6.67	7.37	10	10.3	19.4
SMF6.5A	SMF6.5CA	KK	6VC	6.5	250	7.22	7.98	10	11.2	17.9
SMF7.0A	SMF7.0CA	KM	7C	7.0	100	7.78	8.60	10	12.0	16.7
SMF7.5A	SMF7.5CA	KP	7VC	7.5	50	8.33	9.21	1	12.9	15.5
SMF8.0A	SMF8.0CA	KR	8C	8.0	25	8.89	9.83	1	13.6	14.7
SMF8.5A	SMF8.5CA	KT	8VC	8.5	10	9.44	10.40	1	14.4	13.8
SMF9.0A	SMF9.0CA	KV	9C	9.0	5	10.00	11.10	1	15.4	13.0
SMF10A	SMF10CA	KX	10C	10.0	2	11.10	12.30	1	17.0	11.8
SMF11A	SMF11CA	KZ	11C	11.0	2	12.20	13.50	1	18.2	11.0
SMF12A	SMF12CA	LE	12C	12.0	2	13.30	14.70	1	19.9	10.1
SMF13A	SMF13CA	LG	13C	13.0	1	14.40	15.90	1	21.5	9.3
SMF14A	SMF14CA	LK	14C	14.0	1	15.60	17.20	1	23.2	8.6
SMF15A	SMF15CA	LM	15C	15.0	1	16.70	18.50	1	24.4	8.2
SMF16A	SMF16CA	LP	16C	16.0	1	17.80	19.70	1	26.0	7.7
SMF17A	SMF17CA	LR	17C	17.0	1	18.90	20.90	1	27.6	7.2
SMF18A	SMF18CA	LT	18C	18.0	1	20.00	22.10	1	29.2	6.8
SMF20A	SMF20CA	LV	20C	20.0	1	22.20	24.50	1	32.4	6.2
SMF22A	SMF22CA	LX	22C	22.0	1	24.40	26.90	1	35.5	5.6
SMF24A	SMF24CA	LZ	24C	24.0	1	26.70	29.50	1	38.9	5.1
SMF26A	SMF26CA	ME	26C	26.0	1	28.90	31.90	1	42.1	4.8
SMF28A	SMF28CA	MG	28C	28.0	1	31.10	34.40	1	45.4	4.4
SMF30A	SMF30CA	MK	30C	30.0	1	33.30	36.80	1	48.4	4.1
SMF33A	SMF33CA	MM	33C	33.0	1	36.70	40.60	1	53.3	3.8
SMF36A	SMF36CA	MP	36C	36.0	1	40.00	44.20	1	58.1	3.4
SMF40A	SMF40CA	MR	40C	40.0	1	44.40	49.10	1	64.5	3.1
SMF43A	SMF43CA	MT	43C	43.0	1	47.80	52.80	1	69.4	2.8
SMF45A	SMF45CA	MV	45C	45.0	1	50.00	55.30	1	72.7	2.7
SMF48A	SMF48CA	MX	48C	48.0	1	53.30	58.90	1	77.4	2.6

ELECTRICAL CHARACTERISTICS (TA=25°C,continued)

Part Number		Marking		V _R	I _R @ V _R	V _{BR} @I _T		I _T	V _C @I _{PP}	I _{PP} ①
Uni-Polar	Bi-Polar	Uni	Bi	V	μA	min(V)	max(V)	mA	max(V)	A
SMF51A	SMF51CA	MZ	51C	51.0	1	56.70	62.70	1	82.4	2.4
SMF54A	SMF54CA	NE	54C	54.0	1	60.00	66.30	1	87.1	2.3
SMF58A	SMF58CA	NG	58C	58.0	1	64.40	71.20	1	93.6	2.1
SMF60A	SMF60CA	NK	60C	60.0	1	66.70	73.70	1	96.8	2.0
SMF64A	SMF64CA	NM	64C	64.0	1	71.10	78.60	1	103.0	1.9
SMF70A	SMF70CA	NP	70C	70.0	1	77.80	86.00	1	113.0	1.8
SMF75A	SMF75CA	NR	75C	75.0	1	83.30	92.10	1	121.0	1.7
SMF78A	SMF78CA	NV	78C	78.0	1	86.70	95.80	1	126.0	1.6
SMF85A	SMF85CA	NX	85C	85.0	1	94.40	104.0	1	137.0	1.5
SMF90A	SMF90CA	NZ	90C	90.0	1	100.0	111.0	1	146.0	1.4
SMF100A	SMF100CA	PE	100C	100.0	1	111.0	123.0	1	162.0	1.2
SMF110A	SMF110CA	PG	110C	110.0	1	122.0	135.0	1	177.0	1.1
SMF120A	SMF120CA	PK	120C	120.0	1	133.0	147.0	1	193.0	1.0
SMF130A	SMF130CA	PM	130C	130.0	1	144.0	159.0	1	209.0	0.9
SMF150A	SMF150CA	PR	150C	150.0	1	167.0	185.0	1	243.0	0.8
SMF160A	SMF160CA	PV	160C	160.0	1	178.0	197.0	1	259.0	0.8
SMF170A	SMF170CA	PX	170C	170.0	1	189.0	209.0	1	275.0	0.7
SMF180A	SMF180CA	PZ	180C	180.0	1	201.0	222.0	1	292.0	0.7
SMF200A	SMF200CA	QE	200C	200.0	1	224.0	247.0	1	324.0	0.6
SMF220A	SMF220CA	QR	220C	220.0	1	246.0	272.0	1	356.0	0.5

① Surge waveform:10/1000μs

V_R: Stand-off voltage -- maximum voltage that can be applied

V_{BR}: Breakdown voltage

V_C: Clamping voltage -- peak voltage measured across the suppressor at a specified I_{PP}

I_R: Reverse leakage current

ORDERING INFORMATION

<p>SMF</p> <p>200W SOD-123FL Series</p>	<p>XX</p> <p>V_R Voltage</p>	<p>C</p> <p>C: Bi-directional</p>	<p>A</p> <p>5% V_{BR} voltage tolerance</p>
--	--	--	---

RATINGS AND V-I CHARACTERISTICS CURVES ($T_A=25^\circ\text{C}$, unless otherwise noted)

FIG.1:V- I curve characteristics (Uni-directional)

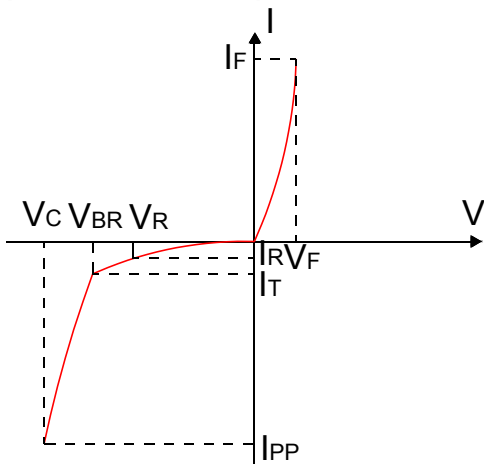

FIG.2:V- I curve characteristics (Bi-directional)

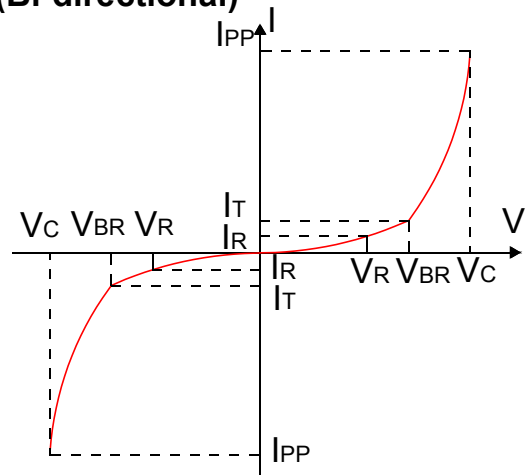

FIG.3: Pulse waveform

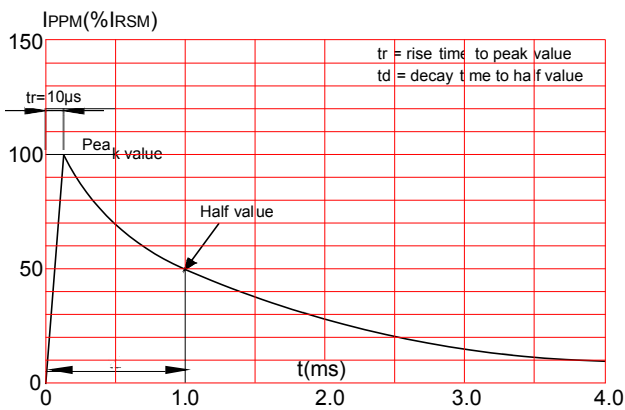
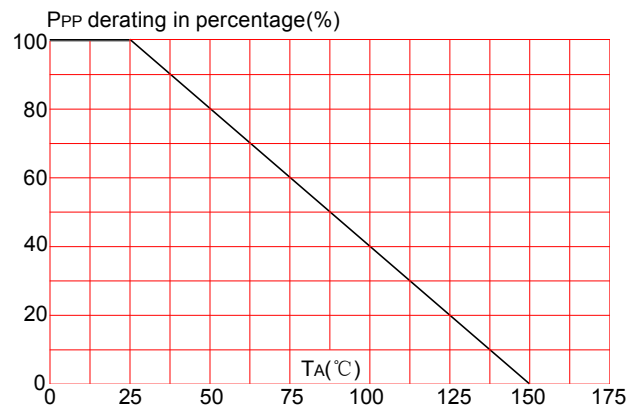
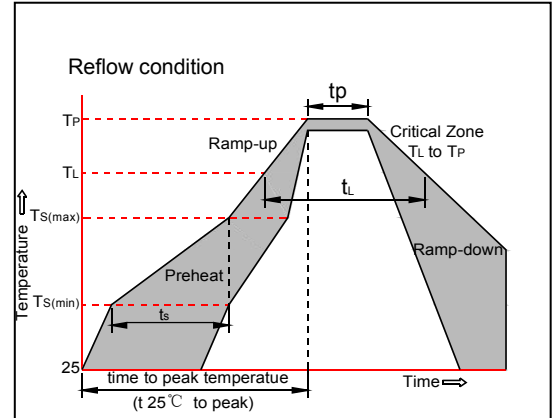
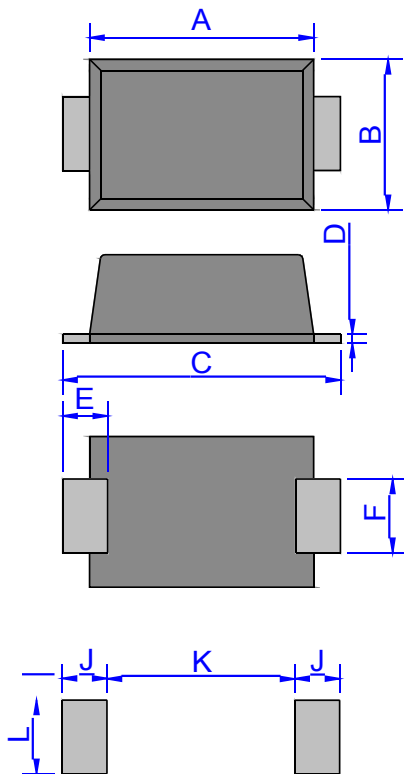

FIG.4: Pulse derating curve



SOLDERING PARAMETERS

Reflow Condition		Pb-Free assembly (see figure at right)
Pre Heat	-Temperature Min ($T_{s(min)}$)	+150°C
	-Temperature Max($T_{s(max)}$)	+200°C
	-Time (Min to Max) (t_s)	60-180 secs.
Average ramp up rate (Liquidus Temp (T_L) to peak)		3°C/sec. Max
$T_{s(max)}$ to T_L - Ramp-up Rate		3°C/sec. Max
Reflow	-Temperature(T_L)(Liquidus)	+217°C
	-Temperature(t_L)	60-150 secs.
Peak Temp (T_p)		+260(+0/-5)°C
Time within 5°C of actual Peak Temp (t_p)		20-40secs.
Ramp-down Rate		6°C/sec. Max
Time 25°C to Peak Temp (T_p)		8 min. Max
Do not exceed		+260°C

PACKAGE MECHANICAL DATA

SOD-123FL

Ref.	Dimensions			
	Millimeters		Inches	
	Min.	Max.	Min.	Max.
A	2.60	3.00	0.102	0.118
B	1.60	2.00	0.063	0.079
C	3.45	3.95	0.136	0.156
D	0.10	0.25	0.004	0.01
E	0.3	0.9	0.012	0.035
F	0.80	1.20	0.031	0.047
G	0.95	1.35	0.037	0.053
J	1.30		0.051	
K		1.70		0.067
L	1.30		0.051	

TAPE AND REEL SPECIFICATION-SOD-123FL

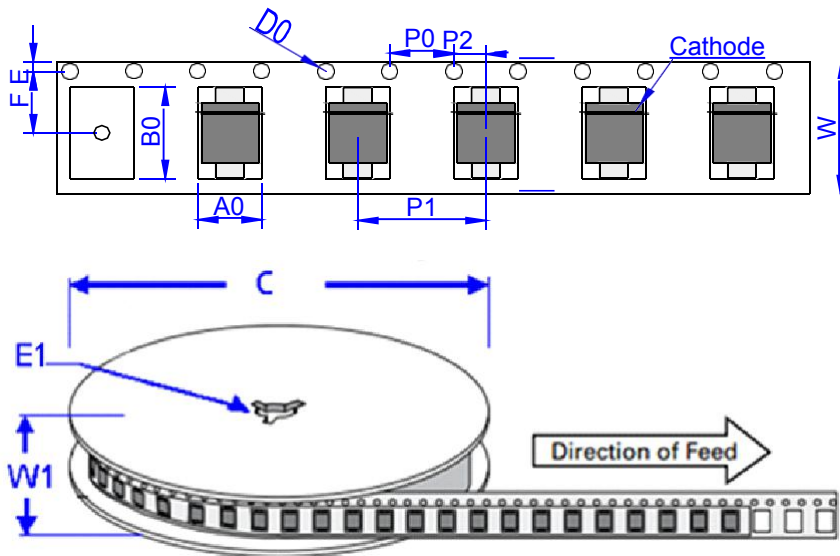

Ref.	Dimensions	
	Millimeters	Inches
A0	1.95 ± 0.3	0.077 ± 0.012
B0	3.95 ± 0.3	0.156 ± 0.012
C	178	7.0
D0	1.55 ± 0.1	0.061 ± 0.004
E	1.75 ± 0.2	0.069 ± 0.008
E1	13.3 ± 0.3	0.524 ± 0.012
F	3.50 ± 0.2	0.138 ± 0.008
P0	4.00 ± 0.2	0.157 ± 0.008
P1	4.00 ± 0.2	0.157 ± 0.008
P2	2.00 ± 0.2	0.079 ± 0.008
W	8.0 ± 0.2	0.315 ± 0.008
W1	11.5 ± 1.0	0.453 ± 0.039

OUTLINE	UNIT WEIGHT (g/PCS) typ.	PACKAGE TYPE	QUANTITY	DESCRIPTION
TAPING	0.0136	SOD-123FL	3000	7 inch reel pack
TAPING	0.0136	SOD-123FL	10000	13 inch reel pack

Website: <http://www.jksemi.com>

For additional information, please contact your local Sales Representative.

©Copyright 2021, jksemi