

3838带透镜单波紫外杀菌贴片式发光二极管**特点 (Characteristics) :**

- * 外观尺寸 (L/W/H) :3.9*3.9*3.25mm
Outline Dimensions (L / w / h): 3.9 x 3.9 x 3.25 mm
- * 发光颜色及胶体: 紫色/透明胶体
Luminous color and colloid: Purple /Transparent colloid
- * 高光输出功率
High light output power
- * 寿命长, 低光衰
Long life and low light attenuation
- * 节能, 高可靠性
Energy saving and high reliability
- * 内置UVC波长芯片, 独特设计应用更广泛
Built in UVC wavelength chip, unique design and wider application
- * 环保工艺符合ROHS要求
Environmental protection products Complied With ROHS Directive

**应用领域 (Product application) :**

- * 杀毒消菌
Disinfect toxin and bacteria
- * 空气和水净化
Air and water purification
- * 紫外探测与通讯技术
Ultraviolet detection and communication technology
- * 食品加工保鲜、食品饮料的包装, 生鲜储存等
Food processing and preservation, packaging of food and beverage, fresh storage, etc
- * 医疗卫生, 皮肤病治疗等
Medical health, skin disease treatment, etc



目录

Catalogue

电性参数	
Electrical Characteristics.....	3
典型特性曲线	
Typical Characteristic Curves.....	4
外形尺寸	
Outline Dimensions.....	5
包装	
Packaging.....	6
焊接指导	
Guideline for Soldering.....	8
使用注意事项	
Precautions.....	10

电性参数

Electrical Characteristics

◇极限参数（温度=25℃）：Absolute Maximum Ratings(Temperature=25℃):

项目 Item	符号 Symbol	最大额定值 Absolute Maximum Rating	单位 Unit
正向电流 Forward Current	IF	100	mA
正向峰值电流 Pulse Forward Current	IFP	120	mA
反向电压 Reverse Voltage	VR	5	V
功率消耗 Power Dissipation	PD	0.5	W
工作温度 Operating Temperature	Topr	-20℃ TO +80℃	℃
贮藏温度 Storage Temperature	Tstf	-20℃ TO +65℃	℃
焊接温度 Soldering Temperature	Tsld	Roflow Soldering:260	for 3sec

光电参数（温度=25℃）：Electro-Optical Characteristics(Temperature=25℃):

参数名称 Parameter	符号 Symbol	测试条件 Condition	数值 Value			单位 Unit
			最小Min	典型Typ	最大Max	
正向电压 Forward Voltage	Vf	IF=100mA	5	-	7	V
辐射功率 Radiation Flux	Φe	-	-	-	-	mW
		UVC	7	-	15	
峰值波长 Peak wavelength	WLP	IF=100mA	270	-	280	nm
反向电流 Reverse Current	IR	VR=-5V	-	-	5	uA
全视角 Viewing angle	2θ1/2	IF=100mA	-	60	-	Deg
晶片节温 Junction temperature	Tj	IF=100mA	-	-	90	℃
热阻 Thermal resistance	Rthj-s	IF=100mA	-	-	3-5	℃/W
抗静电 Antistatic ability	ESD	IF=100mA	2000V			

电压分档:

Voltage grading

代码 Code	最小值 Min	最大值 Max	单位 Unit	测试条件 Test conditions
A21	5.4	5.6	V	IF=100mA
A22	5.6	5.8		
A23	5.8	6.0		

典型特性曲线

Typical Characteristics Curves

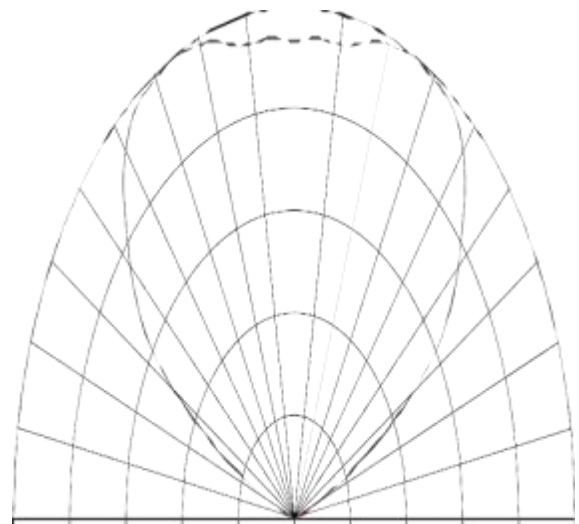
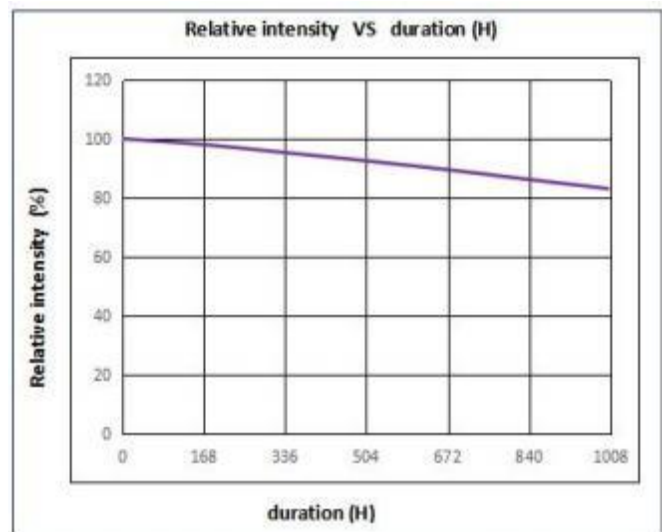
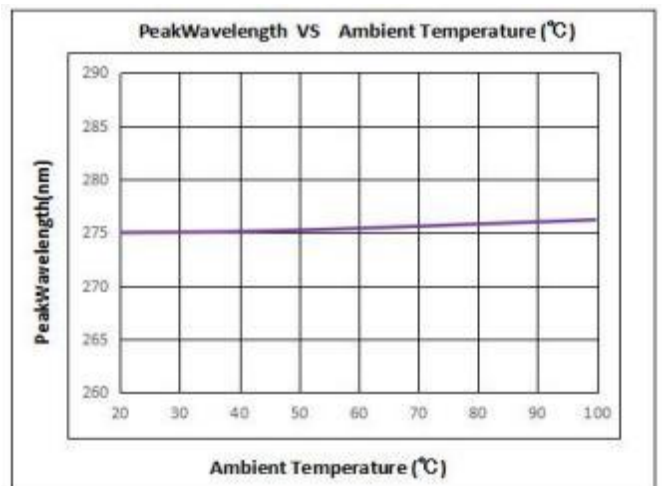
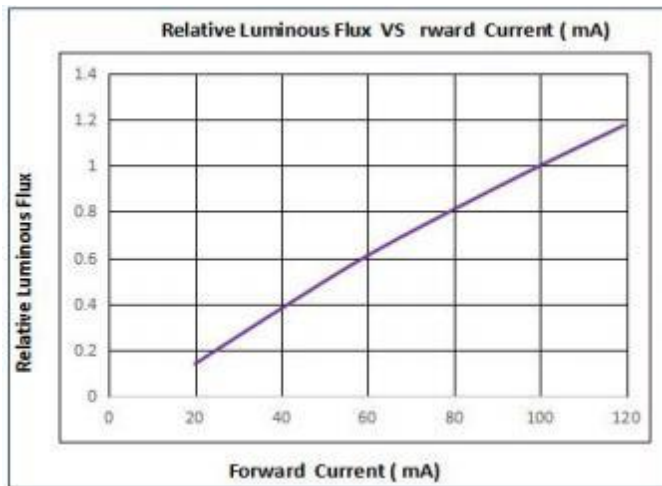
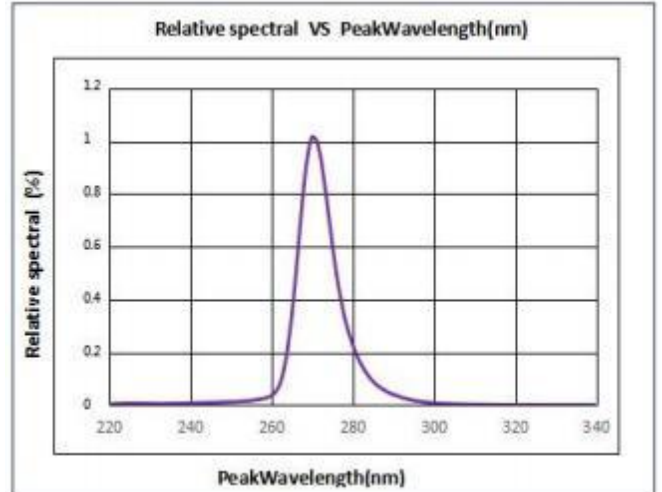
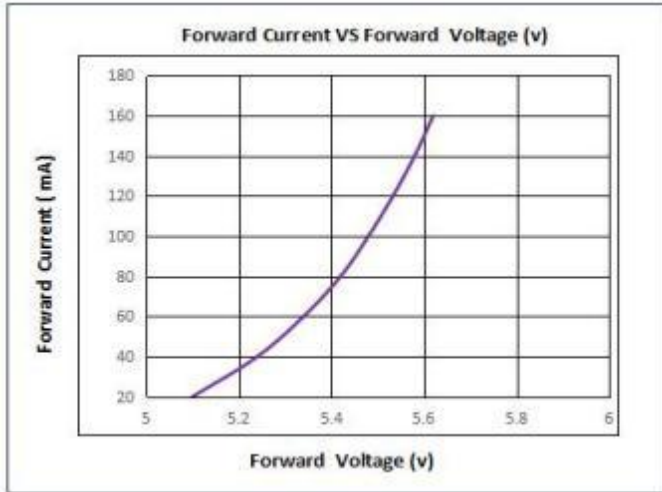

外形尺寸

Outline Dimension

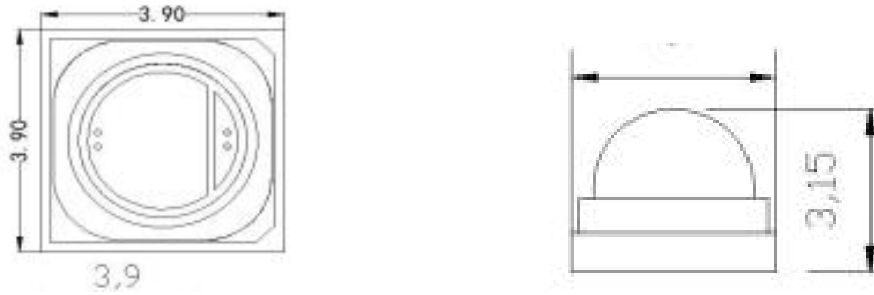

建议焊盘尺寸图
Recommended Soldering Pattern

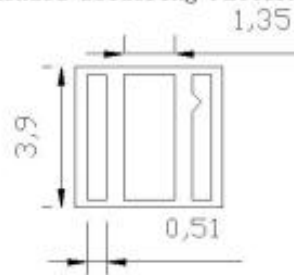

Notes 备注:

- ◆ 1. All dimensions units are millimeters. 所有尺寸标注单位为毫米
- ◆ 2. All dimensions tolerances are $\pm 0.2\text{mm}$ unless otherwise noted. 除特别标注外，所有尺寸公差为 ± 0.2 毫米

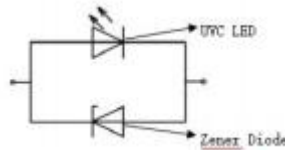

齐纳二极管仅用于提供ESD防护，以免UVC LED芯片遭受静电击穿。同时，我们致力于提高UVC LED芯片自身的抗静电能力，直至无需齐纳二极管防护。若此种结构发生变更，恕不另行通知。

Zener diode is only used to provide ESD protection to avoid electrostatic breakdown of UVC LED chip. At the same time, we are committed to improving the anti-static capability of UVC LED chips until Zener diode protection is not required. This structure is subject to change without notice.

包装 (1)

Packaging (1)

编带包装 Fabric with packaging

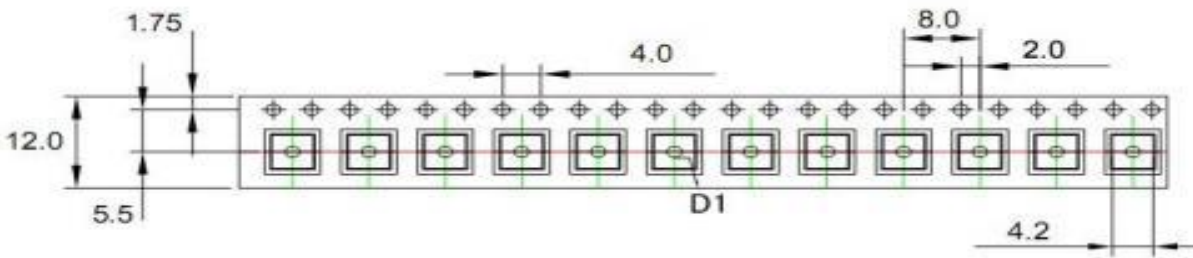

注 (Note) :

1. 尺寸单位为毫米(mm)。
1. Size unit is mm (mm).
2. 尺寸公差是±0.1mm。
2. The dimensional tolerance is ± 0.1mm.

卷轴尺寸 Scroll size

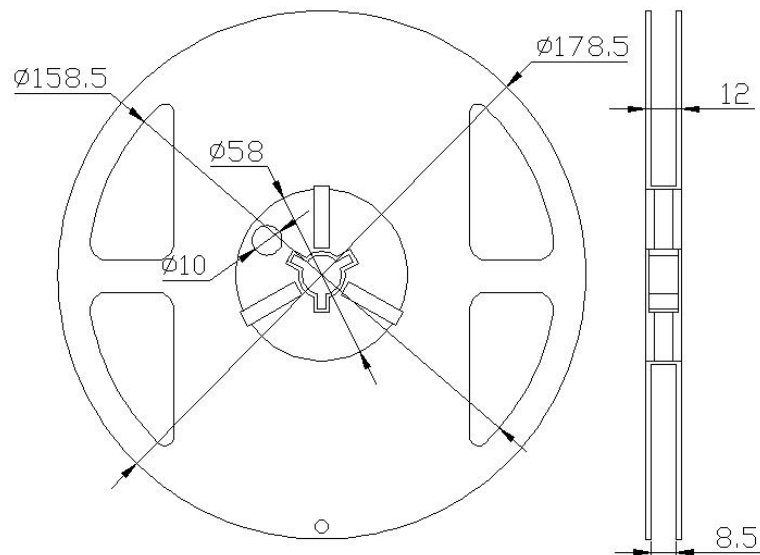

包装 (2)

Packaging (2)

◇ 防潮防静电包装 Moisture Proof and Anti-Electrostatic Foil Bag

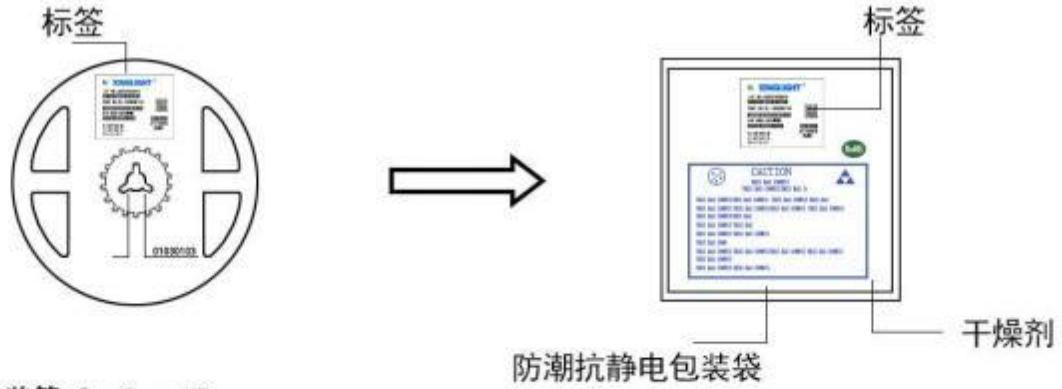

◇ 外包装箱 Cardboard Box

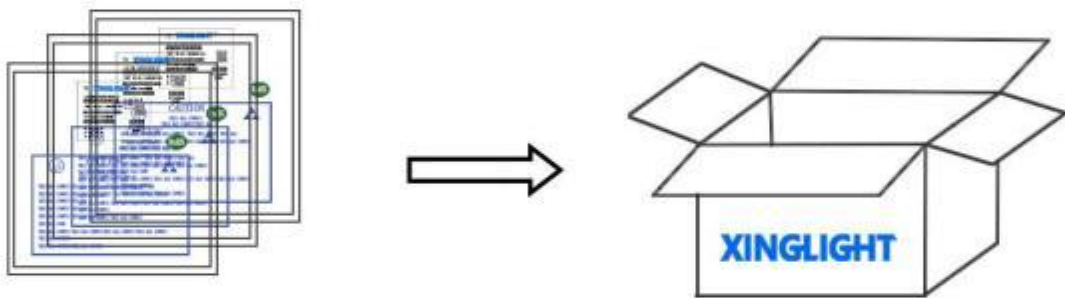

Capacity 5 or 10 reels per box (内箱容量: 50或100卷)

◇ 标签说明: Label Explanation

- LOT NO: 批次信息
- PART NO: 产品型号
- BIN CODE: 产品名称
- WL: 波长范围
- IV: 光强范围
- VF: 电压范围



焊接指导（1）

Guideline for Soldering (1)

建议采用低温锡膏回流焊接，温度曲线参考下图：

Low temperature solder paste reflow soldering is recommended, and the temperature curve is shown in the following figure:

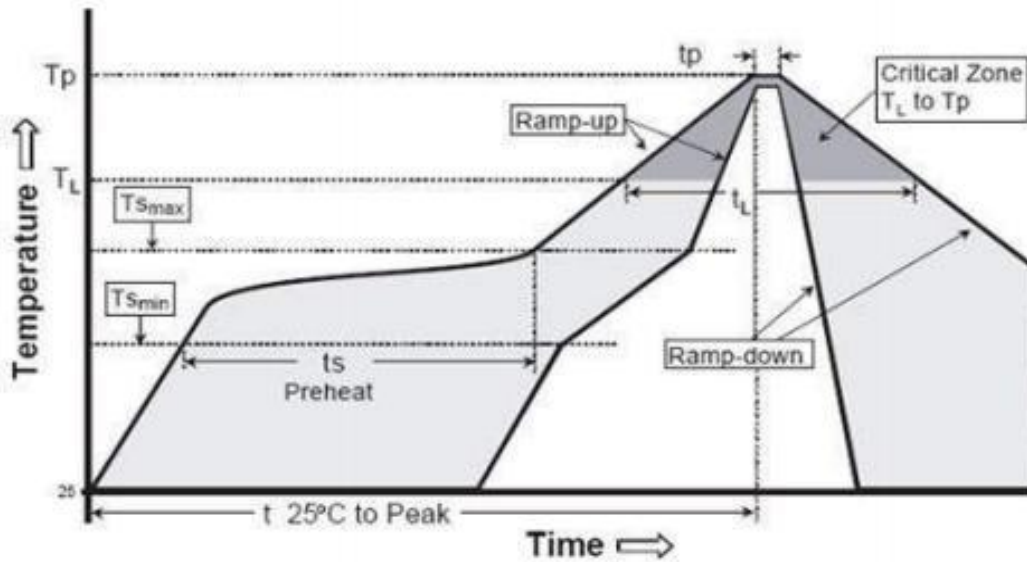

注：
notes

- 1: 实际温度曲线视锡膏的特性、设备性能、基板材料等的不同而可能存在显著不同；
The actual temperature curve may be significantly different depending on the characteristics of solder paste, equipment performance, substrate materials, etc;
- 2: 建议批量作业前多做焊接测试，以获得最佳工艺条件；
It is recommended to conduct more welding tests before batch operation to obtain the best process conditions;
- 3: 不恰当的回流焊条件可能导致焊接失败，或产品金属镀层褪色；
Improper reflow conditions may lead to welding failure or discoloration of product metal coating;
- 4: 灯珠在焊接后不建议再次返修。当修复不可避免时，必须使用双头烙铁，且需确认该方式是否损坏产品本身。
It is not recommended to repair the lamp beads after welding. When repair is unavoidable, a double ended soldering iron must be used, and it is necessary to confirm whether the method damages the product itself

焊接指导 (2)

Guideline for Soldering (2)

2.清洗 Cleaning

在焊接后推荐使用酒精进行清洗，在温度不高于 30°C 的条件下持续 3 分钟，不高于 50°C 的条件下持续 30 秒。使用其他类似溶剂清洗前，请先确认使用的溶剂不会对 LED 的封装和环氧树脂部分造成损伤。

超声波清洗也是有效的方法，一般最大功率不应超过 300W，否则可能对 LED 造成损伤。请根据具体的情况预先测试清洗条件是否会对 LED 造成损伤。

It is recommended that alcohol be used as a solvent for cleaning after soldering. Cleaning is to go under 30°C for 3 minutes or 50°C for 30 seconds. When using other solvents, it should be confirmed beforehand whether the solvents will dissolve the package and the resin or not.

Ultrasonic cleaning is also an effective way for cleaning. But the influence of Ultrasonic cleaning on LED depends on factors such as ultrasonic power. Generally, the ultrasonic power should not be higher than 300W. Before cleaning, a pretest should be done to confirm whether any damage to LEDs will occur.

- * **注意：** 此一般指导原则并不适用于所有 PCB 设计和焊接设备的配置。具体工艺受到诸多因素的影响，请根据特定的PCB设计和焊接设备来确定焊接方案。
- * **Note:** This general guideline may not apply to all PCB designs and configurations of all soldering equipment. The technics in practise is influenced by many factors, it should be specialized base on the PCB designs and configurations of the soldering equipment..

使用注意事项（1）

Precautions (1)

1. 产品的存放：Storage of products

本产品为湿敏性产品，建议存储温度5℃~30℃，湿度40%~65%，密封保存。为保证产品质量，外包装袋未打开的，建议出厂后一年内使用完；外包装袋打开的，建议于24小时内使用完，超过24小时需重新密封存放，下次使用前建议先采取除湿措施：温度：75℃ 时间：6H。

This product is a humidity sensitive product. It is recommended to store it at a temperature of 5 °C~30 °C and a humidity of 40%~65% in a sealed manner. In order to ensure the product quality, it is recommended to use the outer packaging bag that is not opened within one year after leaving the factory; It is recommended that the external packaging bag be used up within 24 hours if it is open. If it exceeds 24 hours, it should be resealed and stored. Before next use, it is recommended to take dehumidification measures: temperature: 75 °C, time: 6H.

2. 产品的取用与安装：How to choose the collet

本产品为静电敏感产品，请注意静电防护。产品在使用前请确认工作台面及生产设备是否接地，操作人员需佩戴静电手环和手套。

This product is electrostatic sensitive, please pay attention to electrostatic protection. Before using the product, please confirm whether the worktable and production equipment are grounded, and operators need to wear electrostatic bracelets and gloves.

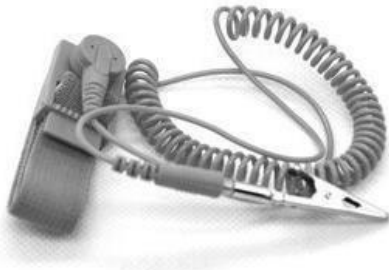

产品的取放应使用镊子夹持其两侧，避免夹持正面透镜，避免用手直接接触。透镜为易碎组件，敲击、震动、撬起、挤压等不当操作易导致透镜碎裂（特别注意）。

The product shall be taken and placed with tweezers on both sides to avoid clamping the front lens and direct contact with hands. The lens is a fragile component. Improper operations such as knocking, vibrating, prying and squeezing may cause the lens to break (special attention).

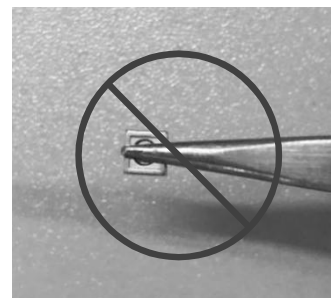
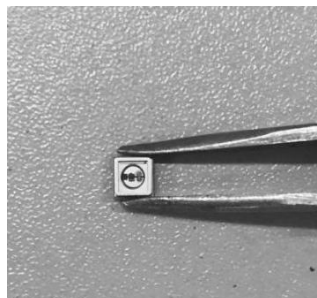
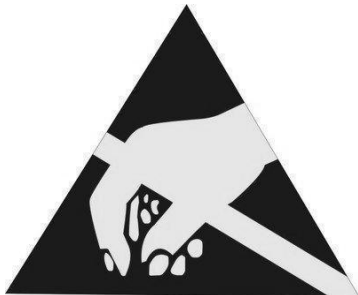

使用注意事项 (2)

Precautions (2)

3: 产品的清洁: Product cleaning

不必要的污染将导致产品光学参数受到剧烈影响。如清洗动作不可避免，推荐使用异丙醇（IPA）为清洗剂进行表面擦拭，请避免使用刷子或超声装置清洗本产品。

Unnecessary pollution will result in severe impact on the optical parameters of the product. If cleaning is unavoidable, it is recommended to use isopropyl alcohol (IPA) as the cleaning agent to wipe the surface. Please avoid using a brush or ultrasonic device to clean the product.

为避免本产品上的金属镀层、透镜被腐蚀，禁止使用任何酸类溶液清洗，尤其是氢氟酸。

To avoid corrosion of metal coating and lens on this product, it is prohibited to use any acid solution for cleaning, especially hydrofluoric acid.

4: 建议电路设计: Suggested circuit design

通常情况下，不同的产品其正向电压和辐射光通量可能存在差异，在电路设计中应充分考虑电流、电压的分配以避免超过本产品绝对最大额定参数。为确保最佳使用效果，建议在矩阵电路中为每一颗产品分配一颗电阻串联。

Generally, the forward voltage and radiant luminous flux of different products may be different. The distribution of current and voltage shall be fully considered in circuit design to avoid exceeding the absolute maximum rated parameters of the product. To ensure the best use effect, it is recommended to assign a resistor in series to each product in the matrix circuit.

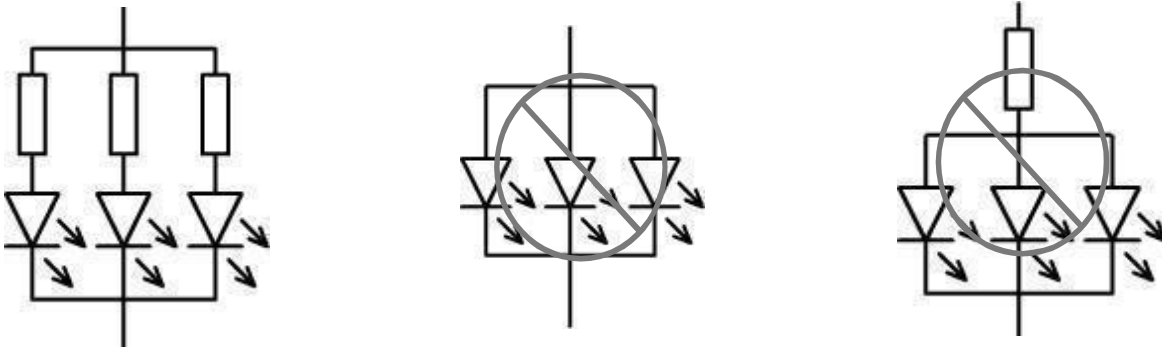

5: 重要安全提示: Important safety tips

本产品在正常通电后会发出深紫外线，直接照射可能对人体皮肤和眼睛造成伤害。建议在操作/使用时身穿防护服，佩戴防护手套和护目镜。严禁未采取防护措施直接照射紫外线或直视紫外线。

This product will emit deep ultraviolet light after normal power on, and direct exposure may cause harm to human skin and eyes. It is recommended to wear protective clothing, gloves and goggles during operation/use. It is strictly forbidden to directly irradiate or look at ultraviolet rays without taking protective measures.



免责声明

Disclaimer

1: 任何超出本规格书中建议的存放条件、使用条件、绝对最大额定参数条件而造成的产品的损坏或连带事故的发生, 深圳市成兴光电子科技有限公司不负任何责任赔偿或连带责任;

1: Shenzhen Chengxing Optoelectronic Technology Co., Ltd. will not be responsible for any compensation or joint liability for any product damage or joint and several accidents caused by exceeding the storage conditions, use conditions and absolute maximum rated parameters recommended in this specification;

2: 为避免任何可能的产品损坏或危害生命健康的风险, 在使用本产品前建议先咨询深圳市成兴光电子科技有限公司

2: In order to avoid any possible risk of product damage or harm to life and health, it is recommended to consult Shenzhen Chengxing Optoelectronic Technology Co., Ltd. before using this product

3: 未经深圳市成兴光电子科技有限公司书面许可, 禁止对本产品进行任何形式的拆解和逆向工程分析。所有有关本产品的分析测试报告, 必须报告给深圳市成兴光电子科技有限公司;

3: Without the written permission of Shenzhen Chengxing Optoelectronic Technology Co., Ltd., it is prohibited to disassemble and reverse engineer this product in any form. All analysis and test reports related to this product must be reported to Shenzhen Chengxing Optoelectronic Technology Co., Ltd;

4: 深圳市成兴光电子科技有限公司尊重并保护知识产权, 未经深圳市成兴光电子科技有限公司可的销售行为直接或间接引发的知识产权纠纷的, 深圳市成兴光电子科技有限公司不承担法律责任;

4: Shenzhen Chengxing Optoelectronic Technology Co., Ltd. respects and protects intellectual property rights. Shenzhen Chengxing Optoelectronic Technology Co., Ltd. will not bear legal liability for intellectual property disputes directly or indirectly caused by sales activities not permitted by Shenzhen Chengxing Optoelectronic Technology Co., Ltd;

5: 本产品任何形式的升级换代, 若非必要, 恕不另行通知;

5: This product is subject to upgrading in any form without notice unless necessary;

6: 本产品规格书中其他未尽事宜, 请致电或邮件咨询我司销售部门。

6: For other matters not covered in this product specification, please call or email our sales department.