

optical

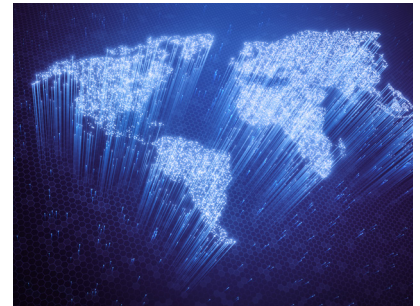
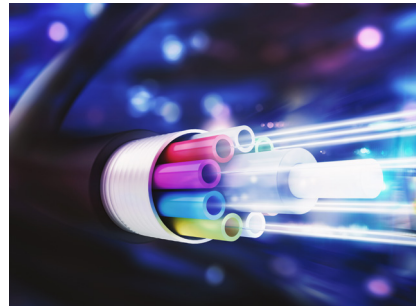

**FEATURING** High Performance Portfolio

# Optical & IC Selector Guide

- FiberEdge™ and PON TIAs
- FiberEdge™ and PON Laser and Modulator Drivers
- Laser and Modulator Drivers
- Single-Lane ClearEdge® CDRs
- Dual-Lane ClearEdge® CDRs
- Quad-Lane ClearEdge® CDRs
- Multi-Lane Signal Conditioners
- ROSAs
- Limiting Amplifiers
- Transceiver ICs
- Optical Reference Design Kits

[www.semtech.com](http://www.semtech.com)



---

## contents

---

Overview	2
Semtech Solutions	3
PAM4 Connected Data Center	5
New Products	6
Optical Applications	7
ClearEdge® CDRs	8
Transceiver ICs (LD and LA)	9
TIAs	10
Laser Drivers (LD) and Limiting Amplifiers (LA)	12
Backplane and Linecard Signal Conditioners	13
ROSAs	14
Optical Module Reference Design Kits	16

---

# High-Performance Optical & Copper Products

Semtech designs the industry's most innovative optical, analog and mixed-signal semiconductor solutions to serve the rising global demand for high-speed data transmission products.

Semtech is an active contributor to networking standards development and has shipped over a billion optical ICs. This combination of real-world experience and industry leadership enables us to deliver best-in-class solutions for our customers' designs.

Semtech offers one of the industry's most comprehensive portfolios of optical transceiver IC products ranging from 100Mbps to over 100Gbps, supporting key industry standards such as Fibre Channel, InfiniBand®, Ethernet, CPRI, PON, OTN, SONET, and PCI Express®. Semtech is also investing in leading-edge technologies to enable communication systems at 400Gbps and beyond.

For our optical component and module customers, this highly differentiated set of products provides a unique roadmap that improves performance and reliability, while simplifying design, lowering costs and speeding time-to-market.

For systems designers and manufacturers working on the next generation of high-speed networks, Semtech's multi-lane and multi-rate 10Gbps-100Gbps backplane solutions provide cost-effective, low power, high-performance products to enable next-generation networks.



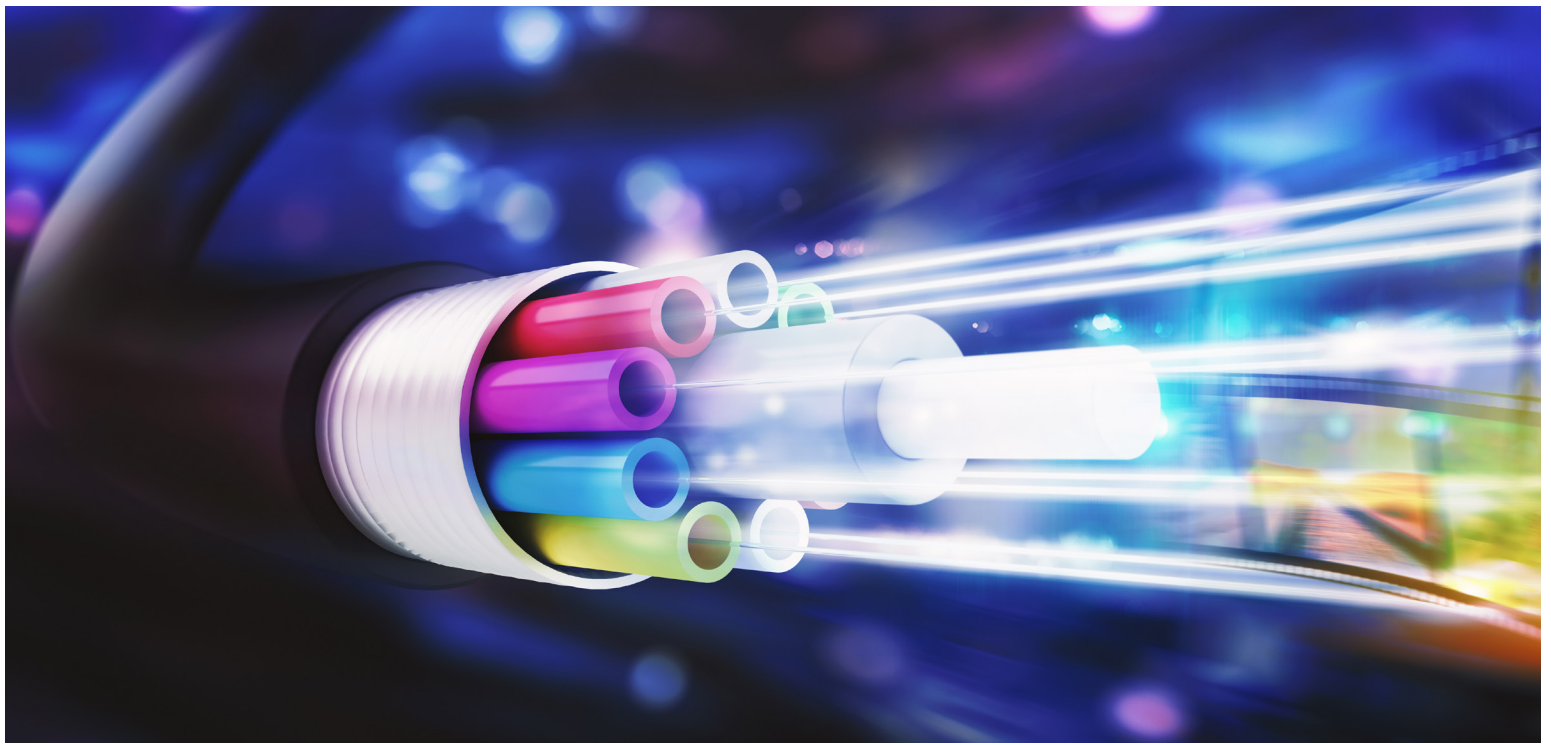

# Semtech Solutions

## Enabling High Performance, High-Speed

- Class leading IC solutions for 10G, 25G, 100G and 400G applications, including SFP28, QSFP28, CFPx, FRx, DRx SRx and AOCs
- Full portfolio of integrated solutions for all PON applications and complete reference designs
- Semtech's ClearEdge® CDR with low power, reference-free technology
- Transimpedance Amplifiers (TIAs) that exceed the IEEE Stressed Receiver Sensitivity (SRS) specifications
- High performance, low power laser drivers
- Receive Optical Sub-Assembly (ROSA) based on Semtech's Rchip technology
- Industry's first single-chip 10G PON OLT transceivers for XGSPON and 10GEPON applications
- Industry's first quad CDRs enabling long reach Infiniband® QDR, 40GbE and 100GbE applications
- Full portfolio of integrated solutions to address all SFP+ and XFP modules
- Dual-lane CDRs (Tx / Rx) with integrated DML or EML driver
- Protocol-independent repeaters / redrivers
- Limiting Amplifiers (LA) that provide wideband, low noise post-amplification
- SFP+ reference design kits for optical modules to decrease design time

## Building the Future Together

As networking requirements continue to evolve, so will Semtech, by working with customers to provide solutions for tomorrow's networking challenges. One thing that won't change, however, is Semtech's commitment to being a reliable supplier and providing innovative approaches that deliver unrivaled performance for the most sophisticated applications.

# Technology Leadership for the Future of Optical Communications

## TECHNOLOGIES

### PAM4

- Chipsets for both 28 and 56 Gbaud applications
- Industry leading linear performance
- Data Center and Wireless markets served

### ClearEdge® CDRs

- Market leader in CDRs
- Reference-free operation
- Integrated solutions enable best performance and lowest power

### TIA

Industry leading performance and proven reliability with over 400 million sold

### Laser Drivers & Limiting Amplifiers

High-performance integrated solutions for single- and multi-channel applications

### ROSAs

Best-in-class sensitivity, based on Semtech's patented Rchip technology

## MARKETS

### 56Gb & 28Gb PAM4 Ethernet

Solutions for 50G, 100G, 200G and 400G as well as AOCs and SRx modules

### 100G Ethernet

Solutions for QSFP28 and CFPx modules as well as 100G AOCs

### 25G Ethernet & eCPRI

Market leading IC and ROSA solutions for SFP28 modules and AOCs

### 10G Ethernet & CPRI

- Complete portfolio of module IC and backplane solutions
- Solutions for XFP, SFP+, QSFP+ modules

### PON / FTTH

- Industry's first fully integrated 10G PON OLT solutions
- Highly integrated chipset solutions for 10G PON ONU

### 16G Fibre Channel

Industry's first complete integrated IC solution for 16G Fibre Channel



# PAM4 Connected Data Center

Over the past several years, PAM4 has emerged as the leading technology for implementation of a new generation of Data Center and Wireless optical links.

Standards such as IEEE 802.3bs and 802.3cd provide a common understanding of link requirements enabling interoperability that will drive the PAM4 communications market to scale, thereby reducing costs. Concurrently, applications such as machine learning and 4K video apply continuous pressure on service providers to provide more, and more bandwidth. Semtech is uniquely positioned to meet the challenges of this market by providing its customers a wide range of solutions specifically tailored to individual application needs.

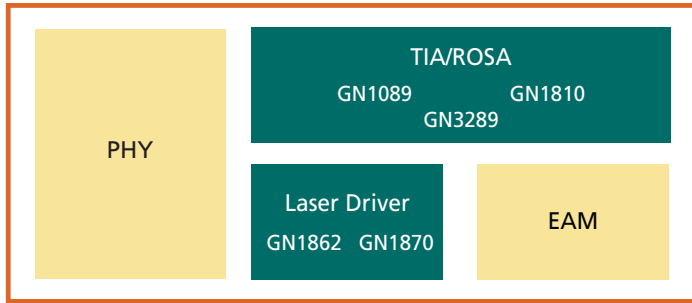

**SINGLE MODE OPTICAL MODULE**

Comprised of Semtech’s market-leading, linear, Physical Media Dependent (PMD) FiberEdge™ products and advanced physical layer devices, our chipsets for single mode applications set the standard for data center applications. Semtech delivers 100Gbps, single lambda solutions that exceed stringent IEEE, OIF and MSA standards with world class electronics specifically designed and orchestrated for optimal performance.

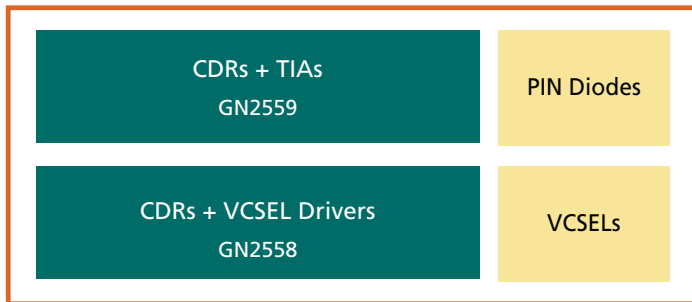

**MULTI-MODE OPTICAL MODULE / AOC**

Leveraging its dominant 25 Gbps ClearEdge® CDR and PMD technologies, Semtech’s highly-integrated, 56Gbps PAM4 devices provide an optimal mix of low power, high performance and cost effectiveness required to meet the demands of the multi-mode market. Whether utilized in Active Optical Cables (AOCs) or in standard optical transceivers, Semtech’s easy to design in multi-mode PAM4 solutions, are the ideal electronics solution for multi-mode optical links.

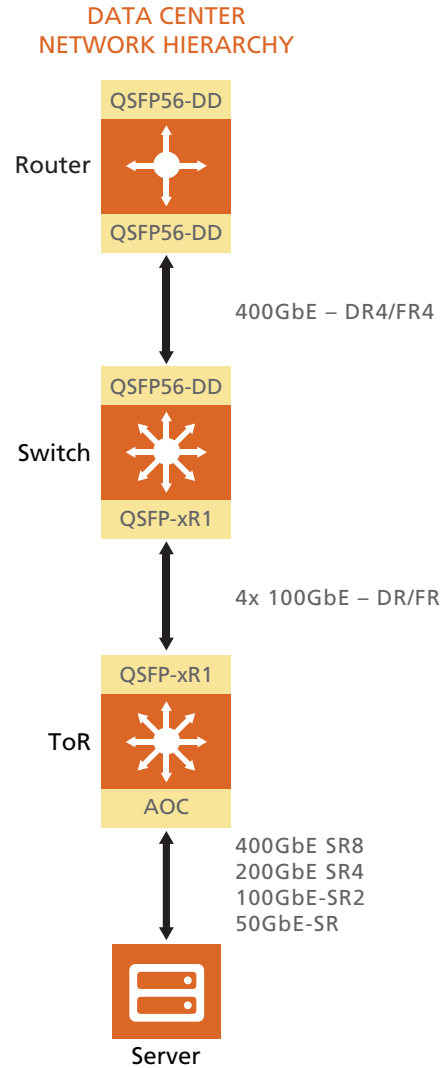

# New Products

---

## **GN2146:** Low-Power Bi-Directional 24-28Gbps ClearEdge® CDR with EML / MZM Driver

- Fully integrated EML / MZM driver and industry-leading ClearEdge® CDR
- Enables <1.5W SFP28 20km DWDM or Tunable modules
- Fully monolithic integrated EML / MZM Driver and ClearEdge® CDR with integrated Bias T components to allow easier layout
- Industry's smallest die size of 5mm x 4mm FC-LFBGA package (including passives) and ultra low power 550mW at 2VppSE (4VppD) swing

## **GN2142:** Low-Power Bi-Directional 24-28Gbps ClearEdge® CDR with DML Driver

- Fully integrated DML driver and industry-leading ClearEdge® CDR
- Enables <1W SFP28 300m / 10km modules
- Proprietary DML compensation technology maximizes performance with multiple DML laser vendors including low bandwidth lasers

## **GN2105B:** Low-Power Quad 24-28Gbps ClearEdge® CDR with DML Driver

- Fully integrated Quad DML driver and industry-leading ClearEdge® CDR
- Enables <3.5W 100G QSFP28 PSM4 to LR4 designs, when coupled with GN2104S or GN2110B
- DC Coupled DML driver allows for Chip-on-board and Passive DML TOSA applications
- Proprietary DML compensation technology maximizes performance with multiple DML laser vendors

## **GN2147 / GN2148 / GN2149:** Low-Power Dual 24-28Gbps ClearEdge® CDRs with Integrated VCSEL Driver and TIA

- GN2147 offers industry's higher integrated with Dual CDR + VCSEL Driver + TIA integrated in a compact single die size of 1.7 x 3.0mm
- GN2148 and GN2149 offers customer flexibility with CDR + VCSEL integration and CDR + TIA integration, respectively in a small die size of 1.2 x 2.9mm
- Enables low cost, high-performance 25Gbps AOCs and SFP28 SR modules

## **GN1196:** 1.0 to 12.5Gbps LR Transceiver Chip with Digital Diagnostics

- Based on industry proven GN1157 / B
- Full suite of flexible Digital Diagnostics modes
- Advanced eye-shaping features
- 100mA modulation and bias currents

## **GN2104S / SC:** Low-Power Quad ClearEdge® CDR 24-28Gbps

- Low power dissipation (340mW typical)
- Compact footprint ideal for QSFP28 and CFP4 modules

## **GN2106ST:** Low-Power Quad ClearEdge® CDR With Integrated SE EML Driver, 24-28Gbps with Integrated Bias T Components

- Fully monolithic integrated quad SE EML Driver and ClearEdge® CDR with integrated Bias T components to allow easier layout
- Industry's smallest die size of 6mm x 5mm FC-LFBGA package (including passives) and ultra low power of 790mW at 1.5VppSE swing
- Provides reference-free signal conditioning for QSFP28 modules

## **GN2504:** Low-Power Quad ClearEdge® CDR 25-28Gbps Reference-Free Repeater

- Provides reference-free signal conditioning on backplanes and linecards
- Low power dissipation (600mW typical)

## **GN2108S:** Quad 24-28Gbps Transmitter Array for SR4

- Integrated ClearEdge® CDR and VCSEL array driver
- Small die size of 3mm x 2mm
- Enable extended reach up to 300m on OM4, and 150m on OM3

## **GN2109S / 10S:** Quad 24-28Gbps Receiver Array for SR4

- Integrated TIA array and ClearEdge® CDR offers industry leading performance for both 850nm and 1310nm applications
- Small die size of 3mm x 2mm
- 250um channel pitch

## **GN7154 / 7056:** 10GEPON OLT Chipset

- 10G EML / CDR with dual output burst mode limiting amplifier
- GN7056 high sensitivity 10GEPON OLT TIA

## **GN25L99:** GPON OLT Combo IC

- 2.5G dual loop Tx, 1.25G burst mode Rx
- Highly integrated, low BOM cost and compact size

# Optical Applications

Semtech offers a comprehensive selection of optical transceiver ICs and components for all 1-10GbE, CPRI, OC-192, and 100G module form factors.

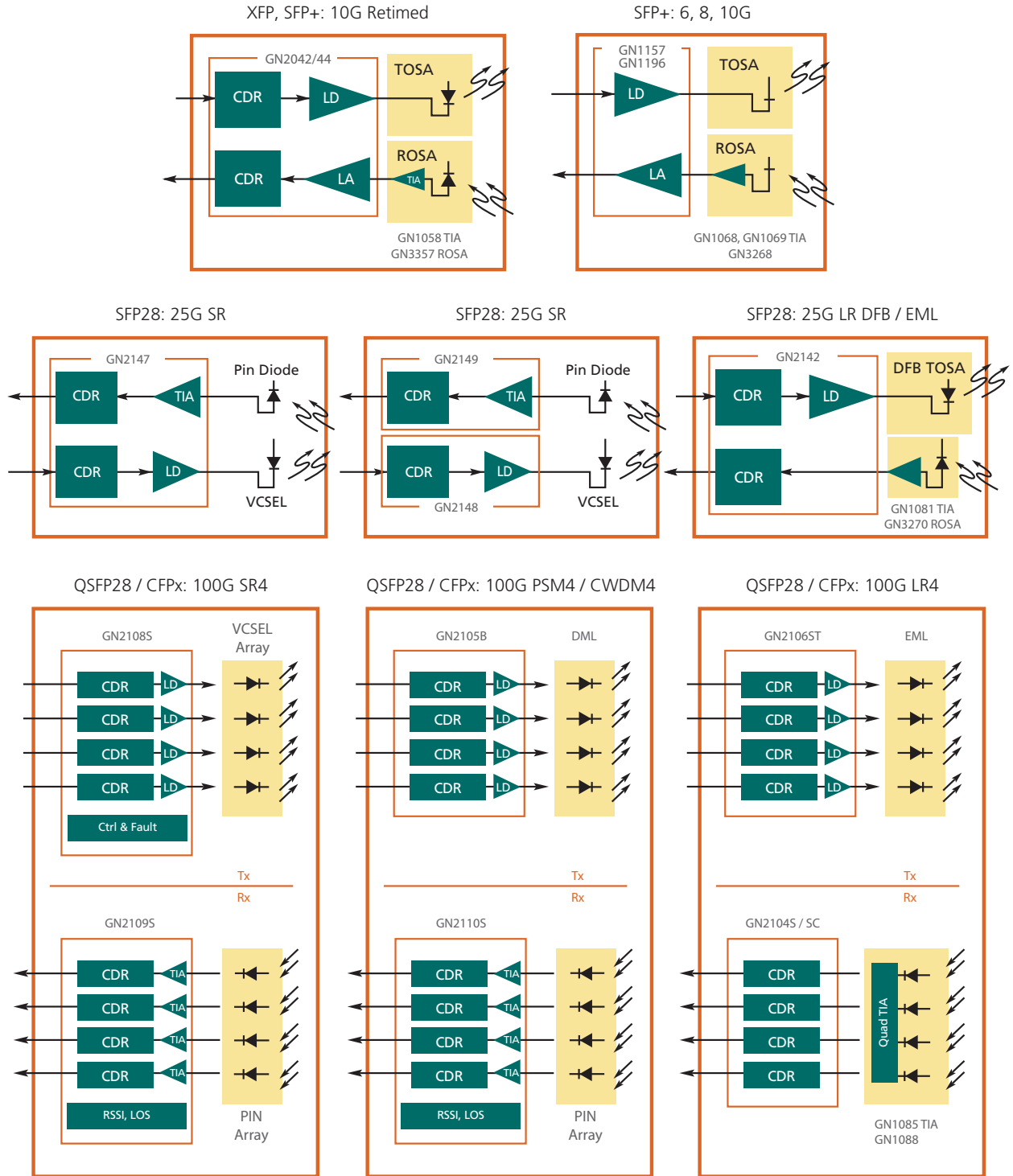

# ClearEdge® CDRs

Semtech's multi-lane signal conditioners, based on our reference-free ClearEdge® CDR platform with integrated drivers and TIAs, offer the lowest power, smallest footprint solutions for XFP, retimed SFP+, 25G and 100G modules, in addition to AOCs.

## ENABLING NEXT-GENERATION 100G MARKETS

Semtech's 100G ClearEdge® CDR portfolio integrates our proven Quad 24G-28G CDRs with VCSEL, DML or EML drivers for transmit with TIAs for receive, targeting both short reach and long reach modules. Our proven integration and the industry's lowest power and superior performance simplifies 100G designs and lowers cost.

## ENABLING SFP28 AND 25GBPS AOCs

The GN2147 dual CDR with integrated VCSEL driver and TIA enables high-performance and low cost SFP28 SR

modules and AOCs. The single chip design and advanced transmit compensation provides for low cost solutions using a single lens design as well as low bandwidth VCSELs for exceptional BOM savings.

## FEATURE SET FOR DWDM AND TUNABLE APPLICATIONS

The GN2040 family has a rich feature set to enable optimal performance in DWDM and Tunable applications. The features include slice level adjust, programmable peaking on the receive path input and sampling clock phase adjust.

ClearEdge® CDRs								
Part Number	Data Rate (Gbps)	Lanes	Laser Driver	TIA	Slice Level Adjust	Pin Compatibility	Package	Applications
GN2042*	9.95–11.3	2 (1Rx + 1Tx)	DML	–	Yes	GN2044	QFN-32	XFP and SFP+, 10GbE and OC-192 Enables 1W Retimed SFP+10km
GN2044*	9.95–11.3	2 (1Rx + 1Tx)	EML	–	Yes	GN1444, GN2042	QFN-32	XFP and SFP+ 10GbE, OC-192 and DWDM Enables 1.5W Retimed SFP+ 40 / 80km
GN2044S*	9.95–11.3	2 (1Rx + 1Tx)	EML	–	Yes	GN1444S	QFN-32	Tunable SFP+, OC-192 and DWDM Enables 1.5W Retimed TSFP+
GN2040*	9.95–11.3	2 (1Rx + 1Tx)	DML	–	Yes	GN204x	QFN-32	XFP and SFP+, 10GbE, OC-192 and DWDM
GN2017A*	9.95–11.7 14.025	2 (1Rx + 1Tx)	VCSEL	–	No	GN2010X	QFN-32	16G FC, 10G FCoE
GN2104S / SC*	24–28	4	–	–	Yes	–	FC-CSP	100Gbps Ethernet, Infiniband EDR
GN2106ST*	24–28	4	EML	–	Yes	–	BGA	100Gbps Ethernet / OTN, Infiniband EDR
GN2108S*	24-28	4	VCSEL	–	Yes	–	Die	100Gbps Ethernet SR4
GN2109S / 10S*	24–28	4	–	Yes	Yes	GN2109S	Die	100Gbps Ethernet / OTN PSM4, CWDM4, CLR4
GN2105B*	24–28	4	DML	–	Yes	–	FC-BGA	100Gbps Ethernet, PSM4, CWDM4, CLR4
GN2147*	24–28.1	2 (Rx + Tx)	VCSEL	Yes	–	–	Die	25Gbps AOC
GN2148*	24–28.1	1 Tx	VCSEL	–	–	–	Die	SFP28 SR
GN2149*	24–28.1	1 Rx	–	Yes	–	–	Die	SFP28 SR
GN2142*	24–28	2 (Rx + Tx)	DML	–	–	CSP	CSP	SFP28 LR
GN2146*	24–28	2 ( Rx + Tx)	EML / MZM	–	–	FC-BGA	–	SFP28 300m / 10km

\* Please contact your sales representative for more details.



# Transceiver ICs (LD & LA)

High-performance laser drivers and limiting amplifiers for optical communications.

## GN28L95

Combined 10Gbps limiting post amplifier and 2.5Gbps burst mode laser driver for cost critical 10GEPON and XG-PON asymmetric applications. GN28L95 features robust automatic ER control and integrated APD controller.

## GN28L96

10G PON combo for next-generation systems. The GN28L96 integrates a 10G burst mode laser driver with dual loop ER control and a 10G limiting amplifier. GN28L96 targets low cost for BoB ONU and module applications.

## GN1157 / 57B / 59 / 58 / 96

Semtech's latest, lowest power transceiver IC for SFP+ LR / SR applications with integrated APC and advanced eye shaping features.

## GN25L96

2.5Gbps CMOS programmable burst mode laser driver and post amplifier optimized for wide laser compatibility and SuperTIA sensitivity.

## GN25L98

2.5Gbps CMOS burst mode laser driver and limiting post amplifier with automatic ERC control and integrated APD controller.

## GN1444 / 44S

The GN1444 and GN44S are highly-integrated, low-power, small footprint transceivers that are ideal for SFP+ ER optical modules.

Transceiver IC (LD and LA)						
Part Number	Overview	Data Rate (Gbps)	Max Mod / Bias Current (mA)	Supply (V)	Package	Applications
GN25L95	Burst Mode DFB + Receive LA	to 2.5	90 / 100	3.3	QFN-28	EPON, GPON, BOSA-on-Board
GN25L96	Programmable Burst Mode DFB + Receive LA	to 2.5	90 / 100	3.3	QFN-28	EPON, GPON, BOSA-on-Board, SFP
GN25L98	Burst Mode DFB + Receive LA + APD Controller	to 2.5	90 / 100	3.3	QFN-28	EPON, GPON, BOSA-on-Board
GN25L95C	SFP Burst Mode DFB + Receive LA	3.1G to 125M	90 / 100	3.3	QFN-28	Single and multi-rate SFP
GN28L95	2.5Gbps Burst Mode DFB + 10Gbps Receive LA	Rx 10.3, Tx 2.4G	100 / 85	3.3	QFN-32	10GbE EPON, XG-PON (Asymmetric)
GN7355	Burst Mode DFB + Receive LA	10.3	120 / 120	3.3	QFN-32	10GbE EPON, XG-PON (Symmetric)
GN1444S*	EML Laser Driver + Receive LA	to 11.3	2.5Vpp / 120mA	1.8 and 3.3	QFN-32	10GbE, OC-192
GN1157	DML Laser Driver + Receive LA	to 11.3	90 / 120	3.3 (Optional 2.8)	QFN-28	10GbE LR SFP+, CPRI
GN1157B*	DML Laser Driver + Receive LA	to 12.5	90 / 120	2.4 and 3.3	QFN-28	10GbE LR SFP+, CPRI
GN1158	VCSEL Laser Driver + Receive LA	to 11.3	20 / 15	3.3 (Optional 2.8)	QFN-28	10GbE SR SFP+
GN1159*	1.0 to 12.5Gbps LR Transceiver Chip with Digital Diagnostics	to 12.5	90 / 120	2.4 and 3.3	QFN-32	10GbE LR SFP+, CPRI
GN1196*	1.0 to 12.5Gbps LR Transceiver Chip with Digital Diagnostics	to 12.5	100 / 100	2.4 and 3.3	QFN-32	10GbE LR SFP+, CPRI

\* Please contact your sales representative for more details.

# TIA's

Wideband, low noise transimpedance amplifiers (TIAs) for optical communication applications.

Semtech offers a portfolio of fully integrated BiCMOS and pure CMOS transimpedance amplifiers providing wideband, low noise pre-amplification of a current signal from a PIN photodiode or APD.

Semtech's TIAs offer best-in-class performance in limiting, linear or automatic gain control versions for use in high-performance optical receivers operating from 155Mbps to 100Gbps.

## FEATURES

- Wideband, low noise
- Limiting, linear and AGC versions
- Fully integrated on-chip de-coupling for low cost and best performance

## APPLICATIONS

- ITU / IEEE-based transmission systems
- 10G and 100G Ethernet
- SONET / SDH based transmission systems, test equipment and optical modules from OC-3 to OC-192
- 8G and 16G Fibre Channel
- Serial data systems up to 28Gbps
- PON / FTTH systems – EPON, GPON, 10GEPON, XGPON and XGSPON
- 6G and 1–12G CPRI modules for wireless front haul
- 100Gbps client side modules

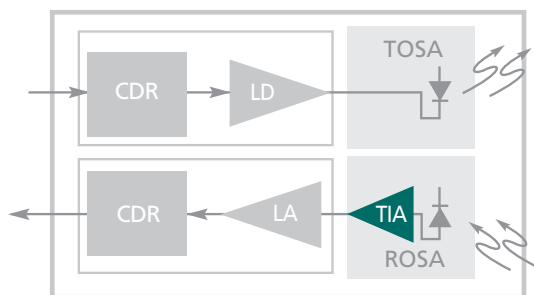

## GN1081, GN1084, GN1085, GN1088

1 x 28Gbps and 4 x 28Gbps limiting TIA optimized for 100GBASE-LR4 applications.

## GN7069

10Gbps limiting TIA designed for APD applications such as 5GHz WiFi immune 10G PON ONU's.

## GN7055, GN7056

Limiting TIA designed specifically for XGSPON and 10G EPON OLT applications.

## GN1068, GN1069

12.5-14Gbps multi-rate limiting TIA providing high gain and wideband performance for use in Ethernet and 16G Fibre Channel applications.

## GN1056

10Gbps linear TIA for high-performance APD applications such as ultra-long haul telecom and submarine applications.

## GN1058

10Gbps high gain TIA optimized for applications requiring AGC, such as 10GBASE-LRM and DWDM receivers for low OSNR environments.

## GN1090

Quad 14.5Gbps array receiver for parallel and multi-channel datacom and telecom modules. Advanced receiver design for excellent optical performance and very low power consumption (240mW total for 4 channels). Use with GN1190 Quad VCSEL Driver.

## GN25L54

2.5Gbps Super TIA for GPON ONU with low cost build.

### NT24L55

Ultra high sensitivity, high-performance CMOS 1.25Gbps TIA with 35dB of dynamic operating range designed for FTTH applications such as GEAPON transceivers and long haul telecom / datacom applications.

### NT24L50

1.25Gbps high sensitivity TIA with automatic gain control for FTTH and Datacom Fiber transceiver applications.

### NT23L50

622Mbps high sensitivity TIA for FTTH and Telecom Fiber transceiver applications.

### NT20R67

Low cost 3.3V to 5.0V CMOS PIN TIA with automatic gain control and more than 43dB dynamic range for Optical Fiber applications up to 200Mbps.

TIAs							
Part Number	Overview	Data Rate (Gbps)	Gain (k $\Omega$ )	BW (GHz)	Supply (V)	Noise	Applications
NT20R67	155Mbps AGC TIA	0.155	63	0.165	3.3 / 5.0	11nA	OC-3, Fast Ethernet
NT20067	155Mbps AGC TIA	0.155	23	0.165	3.3 / 5.0	11nA	OC-3, Fast Ethernet
NT23L50	622Mbps AGC TIA	0.622	50	0.32	3.3	60nA	OC-12, BPON
NT24L50	1.25Gbps AGC TIA	1.25	25	0.75	3.3	92nA	GbE, EPON
NT24L55	1.25Gbps High Sensitivity AGC TIA	1.25	46	0.75	3.3	74nA	EPON
NT25L51	2.5Gbps AGC TIA	2.5	8	1.7	3.3	230nA	OC-48, GPON (APD)
GN25L53	3.1Gbps AGC TIA	3.1	5.5	1.9	3.3	335nA	CPRI, GPON, OC-48 (APD)
GN25L54	2.5Gbps High Sensitivity AGC TIA	2.5	42	1.4	3.3	80nA	GPON (PD)
NT28L52	10G Limiting	to 10.3	2.35	7	3.3	1.2 $\mu$ A	PON, 10GBASE-SR
GN1056	10G Linear	to 11.3	500 / 1	12	3.3	1 $\mu$ A	OC-192
GN1058	10G Linear AGC	to 11.3	4	12	3.3	1 $\mu$ A	10GBASE-LRM and DWDM
GN7069	10G Limiting	to 11.3	8	10	3.3	0.9 $\mu$ A	APD ROSAs for 10G PON ONU
GN1068	14G Limiting	to 14.3	6.75	12	3.3	1.2 $\mu$ A	CPRI, 10GBASE-SR / LR / ER and 16G FC
GN1069	12.5G Limiting	to 12.5	9	11.5	3.3	0.86 $\mu$ A	-
GN1090	Quad 10G limiting	to 14.3	*	*	3.3	0.9 $\mu$ A	40Gbps Ethernet, Infiniband, QSFP+
GN7050*	1.25G Burst Mode Limiting	1.25	13	1.0	3.3	*	1G EPON OLT
GN7052*	Tri-rate PON TIA	1.25 / 2.5 / 10.3	13 / 1.2 / 2.3	1.1 / 2.5 / 8.7	3.3	*	1.25G EPON / 2.5G XG-PON / 10G EPON OLT
GN7053*	1G GPON Burst Mode Limiting	1.25	1.25	1.5	3.3	*	1G GPON OLT
GN1081*	28G Limiting	28	6	22	3.3	1.78 $\mu$ A	25Gbps and 100Gbps Ethernet / OTN, Infiniband EDR
GN1084*	25G Limiting	25	6	22	3.3	2.3 $\mu$ A	25Gbps and 100Gbps Ethernet
GN1085*	Quad 28G Limiting	28	6	22	3.3	1.78 $\mu$ A	100Gbps Ethernet / OTN, Infiniband EDR
GN1088*	Quad 28G Limiting	28	5	23	3.3	-	-

\* Please contact your sales representative for more details.

# Laser Drivers & Limiting Amplifiers

High-performance laser drivers and limiting amplifiers for optical communications.

## APPLICATIONS

- 100Gbps Ethernet
- 6Gbps and 10Gbps CPRI modules for wireless front haul
- 40G QSFP+ modules
- 8G Fibre Channel
- 9.95Gbps OC-192 and 10.70Gbps OC-192 with FEC
- 10.3Gbps Ethernet
- 10.52Gbps Fibre Channel
- 11.1Gbps Ethernet over SONET / SDH
- 11.3Gbps Fibre Channel with Forward Error Correction

## LIMITING AMPLIFIERS

### NT20045

Low cost 3.0V to 5.5V, 200Mbps limiting amplifier for SONET, SDH, ESCON and Fast Ethernet applications over optical fiber.

### NT24L73

1.25Gbps CMOS limiting amplifier with CML data outputs and signal status in an MSOP package.

## LASER DRIVERS

### GN1185

High-performance Quad 25–28Gbps DML driver for active TOSAs targeting 100G applications.

### NT20042

Low cost 3.3V / 5.0V 300 Mbps LED driver for SONET / SDH, ESCON and Fast Ethernet applications over optical fiber.

### NT22L33

3.3V / 5.0V CMOS laser driver for data rates of 125Mbps to 1.25Gbps.

### GN1163

Very low power laser drivers for DFB / VCSEL applications, RSSI feature for compatibility with our high gain ROSAs, enabling SFP+ modules without limiting amplifiers.

### GN1190

Quad VCSEL driver for parallel and multi-channel datacom and telecom modules. Low power consumption, 210mW typical for 4 channels. Use with GN1090 quad TIA.

LIMITING AMPLIFIERS							
Part Number	Overview	Data Rate (Gbps)	Gain (dB)	BW	Supply (V)	Noise Figure (uV)	Applications
NT20045	200Mbps Limiting Amp	0.2	60	0.125	3.3 / 5.0	80	OC-3, Fast Ethernet
NT24L73	1.25Gbps Limiting Amp	1.25	46	0.938	3.3	300	OC-3, OC-12, GbE

LASER DRIVERS						
Part Number	Overview	Data Rate (Gbps)	Max Mod / Bias Current (mA)	Supply (V)	Pkg	Applications
NT20042	300Mbps LED Driver	0.3	100	3.3 / 5.0	QSOP-16	OC-3, Fast Ethernet
NT22L33	1.25Gbps FP / DFB Laser Driver	1.25	70 / 80	3.3 / 5.0	QFN-24 (4mm)	OC-3, OC-12, GbE
GN1163*	DFB Driver	to 11.9	90 / 120	3.3 (Opt. 2.8)	QFN-24	QSFP+, 10GBASE-LR
GN1190	Quad VCSEL Driver	to 14.3	12 / 12	3.3	Bare Die	40Gbps Ethernet, Infiniband, QSFP+
GN1185*	Quad DFB driver	25-28	55m / 70	2.3 / 3.3	Bare Die	100GbE Ethernet active TOSA

\* Please contact your sales representative for more details.



# Backplane & Linecard Signal Conditioners

Semtech's multi-channel signal conditioners enhance the reach and robustness of high-speed serial links by compensating for transmission losses and resetting crosstalk and jitter budgets.

## HIGH LEVEL OF INTEGRATION AND SMALL FOOTPRINT

Semtech's backplane and linecard signal conditioners are ideal for small form factor modules or dense backplane / linecard applications.

## FULL PORTFOLIO

Semtech products offer solutions for Ethernet, Infiniband, Fibre Channel and PCI Express. Solutions are available with and without CDR functionality.

## DRIVE LONG BACKPLANES OR CABLES

A combination of Equalizer, DFE and ClearEdge® CDR technology allows for an optimal solution to drive long, dense backplanes or cables at high speeds.

## LOW POWER

Semtech's ClearEdge® CDR products require the lowest power in the industry, a key factor as densities increase.

## RESET THE JITTER AND CROSSTALK BUDGETS

Using CDRs reset jitter budgets, substantially increasing the robustness of the system and allowing for design flexibility. Using CDRs in multi-channel systems will also reset crosstalk budgets, an increasing concern at higher data rates.

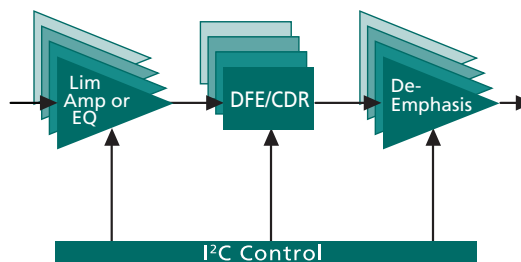

## Multi-Lane Signal Conditioners

Part Number	Data Rate (Gbps)	Lanes	CDR	Ref Clock	Input Stage	De-emphasis	Supply (V)	Pkg	Applications
GN2504*	25.6–28.1	4	Yes	Not Req.	Adaptive Equalizer	Yes	1.8	QFN-54	25G / 50G / 100G Linecards, nx28G Backplanes, 25G / 50G / 100G Active Copper Cables
GT1706 Family*	1.25–14.5	6	Yes	Req.	Adaptive Equalizer	Yes	0.9 1.8	BGA-144	HD / 3G / 4K / 8K Video Broadcast testing Fibre Channel / Infiniband / Ethernet Link Testing BERT Developments
GN2412 Family*	1.25–12.8	12	Yes	Req.	Adaptive Equalizer DFE	Yes	0.9 1.8	BGA-144	>nx10G Backplanes, 10G / 40G / 100G Linecards, 10G-KR, 40G-KR4, 40G-CR4, Crosspoint Switching, CPRI
GN2408 Family*	1.25–12.8	8	Yes	Req.	Adaptive Equalizer DFE	Yes	0.9 1.8	BGA-144	>nx10G Backplanes, 10G / 40G Linecards, 10G-KR, Crosspoint Switching, CPRI
GN2404 Family*	1.25–12.8	4	Yes	Req.	Adaptive Equalizer DFE	Yes	0.9 1.8	BGA-144	>nx10G Backplanes, 10G / 40G Linecards, 10G-KR, 40G-KR4, 40G-CR4, Crosspoint Switching, CPRI
GN2402*	10.3125	4	Yes	Not Req.	Equalizer	Yes	3.3	QFN-44	nx10G Backplanes, 10G / 40G Linecards, 10G / 40G Active cables
GX4002	9.9–11.3, 14.025	2	Yes	Not Req.	Equalizer	Yes	3.3	QFN-32	nx10G Backplanes, 10G / 40G Linecards, Infiniband FDR, 16G Fibre Channel, Crosspoint Switching
GN2405A / 5S*	9.95–11.3	4	Yes	Not Req.	Equalizer	Yes	3.3	QFN-48	nx10G Backplanes 10G / 40G Linecards 10G / 40G Active cables
GN2406 / 6S*	9.95–10.95	4	Yes	Not Req.	Limiting Amp	Yes	3.3	QFN-48	10G / 40G Linecards
GN1407	1–8	4	No	Not Req.	Equalizer	No	1.2 1.8	QFN-56	PCIe Gen 1 / 2 / 3, SNAP-12, POP-4 / LX-4 / CX-4 / KX-4, XAUI / RXAUI and Rapid I / O
GN1406	2.5, 3.125, 5.0, 6.25	4	Yes	Req.	Equalizer	Yes	1.2 1.8	QFN-56	PCIe Gen 1 / 2, SNAP-12, POP-4 / LX-4 / CX-4 / KX-4, XAUI / RXAUI and Rapid I / O

\* Please contact your sales representative for more details.

# ROSAs

Best-in-class receive optical sub-assemblies (ROSAs) based on patented Rchip technology.

Semtech's complete line of PIN and APD ROSA products spans 1310nm nanometer (nm) to 1550nm including limiting, linear and automatic gain control (AGC) functionality. Our PIN ROSAs operate at  $+3.3V \pm 10\%$  and from  $-40^{\circ}C$  to  $+85^{\circ}C$ , with highly accurate RSSI functionality and industry best dynamic range. The ROSA products feature patented Rchip technology packaged in a fully compliant SC or LC type optical subassembly and are available with optional flex circuits.

Super high gain Rchip ROSAs deliver  $35k\Omega$  of gain that eliminates the cost and power of the limiting amplifier for SFP+ applications.

## FEATURES

- Best-in-class stressed receiver sensitivity
- High gain to ensure exceptional crosstalk performance within the module
- Patented Rchip technology to ensure maximum module manufacturing yield
- Super high gain delivers most integrated, lowest power SFP+ solution

## APPLICATIONS

- 10GBASE-SR
- 10GBASE-LR
- 10GBASE-ER
- 10GBASE-LRM
- OC-192 SR-1
- OC-192 IR-2
- 10G EPON
- Low OSNR DWDM
- 8GFC and 10GFC
- 25G Ethernet
- 28GBd and 56GBd PAM4

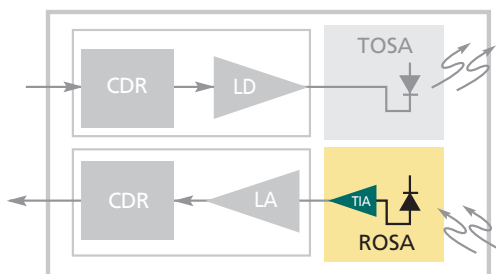

## GN3289

56GBd linear AGC ROSA for up to 100Gbps Ethernet operation using PAM4 modulation. Optimized for low group delay variation, high linearity, and designed to enable cost effective 100Gbps modules.

## GN3270

A limiting 25Gbps PIN ROSA in a TO-46 style co-axial package, with excellent sensitivity performance coupled with low power consumption.

## GN3358

11.3Gbps APD ROSA with high gain limiting TIA with pre-emphasis output designed to eliminate the need for the post amplifier.

## GN3357

11.3Gbps APD ROSA with high gain linear AGC TIA for both 80km limiting and DWDM applications requiring excellent OSNR performance.

## GN3257

10 / 40km linear AGC ROSA offering excellent performance in low-OSNR environments, coupled with low power consumption.

## GN3268

10 / 40km XMD compatible low power (94mW) limiting ROSA.



GN3289

## ROSAs and Super High Gain ROSAs

Part Number	Overview	Data Rate (Gbps)	Gain (kΩ)	Supply	RSSI	Unstressed Sensitivity	Comments	ORL
GN3155*	SR Super High Gain Rchip	to 11.3	35	+3.3V ±10%	Yes	-15dBm OMA	Eliminates LA in SFP+	-14dB
GN3055*	10km Super High Gain Rchip	to 11.3	35	+3.3V ±10%	Yes	-21dBm	Eliminates LA in SFP+	-14dB
GN3255*	40km Super High Gain Rchip	to 11.3	35	+3.3V ±10%	Yes	-21dBm	Eliminates LA in SFP+	-27dB
GN3068*	10km Low Power Limiting	to 11.3	7	+3.3V ±10%	Yes	-21dBm	94mW power dissipation	-14dB
GN3268*	40km Low Power Limiting	to 11.3	7	+3.3V ±10%	Yes	-21dBm	94mW power dissipation	-27dB
GN3257*	PIN with AGC	to 11.3	8.5	+3.3V ±10%	Yes	-19dBm	–	-27dB
GN3357*	High Gain APD with AGC	to 11.3	8.5	+3.3V ±10%	VAPD	-27dBm	–	-27dB
GN3358*	High Gain APD Rchip	to 11.3	13	+3.3V ± 10%	VAPD	-27dBm	Ideal for non-retimed SFP+	-27dB
GN3368*	Limiting APD Rchip	to 11.3	4	+3.3V ±10%	VAPD	-27dBm	–	-27dB
GN3270*	25G Limiting PIN ROSA	28	6	+3.3V ±10%	Yes	-14dBm	SFP28 LR applications	-27dB
GN3289*	56GBd Linear AGC ROSA	to 100	5	+3.3V ±10%	Yes	-7.7dBm OMA	100Gbps Ethernet operation using PAM4 modulation	-27dB

\* Please contact your sales representative for more details.

# Optical Module Reference Design Kits

Improve the performance and time to market of your SFP+ design with Semtech Optical Module Reference Design Kits.

## FAST TIME-TO-MARKET

Semtech's Reference Design Kits offer training through schematics, layout files and a design guide, as well as prompt support from our experienced applications engineers, reducing both design costs and time to market. This type of system is currently executed in the FTTx market, as the ability to reuse the 10G symmetric SFP+ design to address the 10G asymmetric market is incorporated.

## BROAD RANGE OF REFERENCE DESIGNS AVAILABLE

Reference Design Kits are offered to cover a wide variety of SFP+ applications, including symmetrical and asymmetrical PON, and 10GbE SR and LR applications.

For Ethernet SFP+, designs are available for both the traditional architecture (including a LA in the receive chain), as well as a new LA-free architecture enabled by Semtech's High Gain ROSA portfolio.

**GN1157B RDK (RDK-GN1157B-SFP+00)**

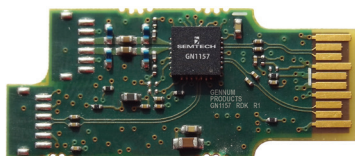

**GN28L96 RDK (GN28L96-10GS-OAM)**

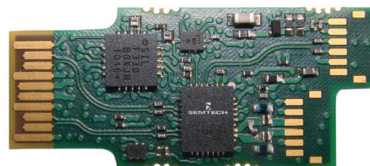

**GN1160 / GN3055 RDK (RDK-SFP+-Optical04)**

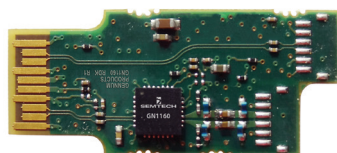

**RDK-SFP++LR**

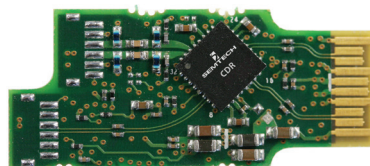

OPTICAL MODULE REFERENCE DESIGN KITS					
Part Number	Parts Demonstrated	Data Rate (Gbps)	Connector Type	Wavelength (nm)	Applications
RDK-SFP++LR	GN3068 / GN3268, GN2010D / GN2042	9.95–11.3	SFP+	1310	10GbE LR, OC-192
RDK-SFP++ER	GN3268, GN2010EA / GN2044	9.95–11.3	SFP+	1550	10GbE ER, OC-192
GN28L96-10GS-OAM	GN28L96	10.3	SFP+	1577 / 1270	10G PON
RDK-SFP+-Optical02	GN1157	1–11.3	SFP+	1310	10GbE LR and CPRI
RDK-GN1157B-SFP+00	GN1157B	1–12.5	SFP+	1310	10GbE LR and CPRI
RDK-SFP+-Optical03	GN1158	1–11.3	SFP+	850	10GbE SR
RDK-SFP+-Optical04	GN1160, GN3055	1–11.3	SFP+	1310	10GbE LR
RDK-SFP+GN1196-00	GN1196	1–12.5	-	-	-

*Design files and results available upon request.*



200 Flynn Road, Camarillo, California 93012 • phone: (805) 498-2111