

1. 适用范围 / SCOPE

6125SB 系列抗浪涌型慢断 (T) 保险丝, 适用于一般电子设备。

6125SB series High InruSB Time Lag Fuse, used in electronic equipment.

2. 产品编码 / Part Numbering

例「example」:

6125	SB	15A	250V/300V				
1	2	3	4	5			

- ① 系列号 / Series Number
- ② 慢断 SB / Slow break
- ③ 额定电流 / Rated Current
- ④ 额定电压 / Rated Voltage
- ⑤ 认证符号 / Approved Symbol

3. 额定电流和额定电压 / RATED CURRENT AND RATED VOLTAGE

额定电流 / Rated Current:

50mA~30A

额定电压 / Rated Voltage:

50mA~30A :65V/125V dc、125V/250V/300V ac

4. 标示 / MARKING

保险丝上需有下列标示 / The fuses SBall have the following marking

① 产品系列标识 / Series type Logo : LB

② 额定电流 / Rated Current (A): ___A

注意 / Note:

对标示的大小和位置没有规定 / Size and position of the markings SBall not be provided.

5. 外观及形状 / APPEARANCES AND CONFIGURATION

5-1 外观: 无显著的污点、铁锈或裂纹; 标示应容易辨识。

Appearances: There SBall not be any remarkable stain, rust or crack on the appearances; marking SBall be easily legible.

5-2 形状: 表面贴装式保险丝

Configuration: Surface Mount Fuse.

6. 工程图和结构 / OUTLINE DRAWING AND STRUCTURE

6-1 工程图（单位：mm） / Outline Drawing and Dimensions (Unit: mm)

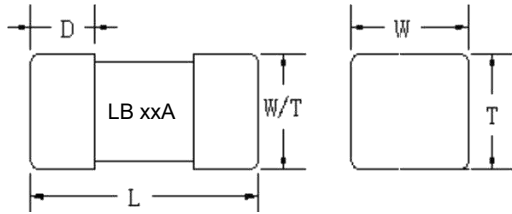

L (mm)	W (mm)	T (mm)	D (mm)
6.10±0.30	2.50±0.20	2.50±0.20	1.45±0.20

6-2 结构 / Structure

编号 No	元件 Component	材质 Material	数量 Quantity
①	熔丝 Wire	合金 Alloy	1
②	铜帽 Cap	黄铜镀银 Brass with silver plated	4
③	本体 Body	陶瓷管 Ceramic Tube	1
④	填充物 Lead	石英砂 Quartz sand	选装项

7. 产品特性 / PRODUCT CHARACTERISTICS

编号 No.	项目 Item	内容 Content	参考标准 Reference standard
1	绝缘阻抗 Insulation resistance	10,000 ohms minimum	MIL-STD-202G, Method 302 Test Condition A
2	可焊性 Solderability	T=240°C±5°C, t=3+0/-0.5s, Cover ≥95%	MIL-STD-202G, Method 208H
3	耐焊接热 Soldering heat resistance	10 sec at 260 °C ΔR :<10%	MIL-STD-202G, Method 210F Test Condition B
4	热冲击 Thermal Shock	100 cycles between -65°C/+125°C 60 minutes ; each extreme ΔR :<10%	IEC 60068-2-14
5	高/低温储存 High/Low Temperature Storage	T=125°C±2°C, 96hours , T=-55°C±3°C, 96hours ΔR : <10%	IEC60068-2-1 / IEC60068-2-2
6	高温操作 High Temperature Operating Life	T=70°C±2°C, 0.6In, 96hours ΔR : <10%	MIL-STD-202 Method 108
7	耐湿性 Humidity(steady state)	T=40°C±2°C, 90%~95%RH, 1000hours ΔR : <10%	MIL-STD-202 Method 103
8	盐雾实验 Salt spray	5% salt solution , 48hours ΔR : <10%	MIL-STD-202G,Method 101E, Test Condition B





8. 电气特性 / ELECTRICAL CHARACTERISTICS

8-1 熔断 / 电流特性: Pre-Arcing Time / Current Characteristic (limits)

In accordance with UL 248-1/-14 and IEC60127-4 standard / 遵循 UL 248-1/-14 和 IEC60127-4

RATED CURRENT	1 IN/倍	1.25 IN/倍	2 IN/倍	10 IN/倍	
	Min	Min	Max.	Min.	Max.
500mA to 30A	4Hr	1Hr	120s	10ms	60ms

8-2 产品规格/Specification

Rated Current 额定电流 (A)	Rated Voltage 额定电压(AC/DC)	Breaking Capacity(A) 分断能力	Safety Approvals 安全认证				
							
50mA	DC 65V/125V AC 125V/250V/300V		●	○	○	○	○
100mA	DC 65V/125V AC 125V/250V/300V		●	○	○	○	○
125mA	DC 65V/125V AC 125V/250V/300V		●	○	○	○	○
160mA	DC 65V/125V AC 125V/250V/300V		●	○	○	○	○
200mA	DC 65V/125V AC 125V/250V/300V		●	○	○	○	○
250mA	DC 65V/125V AC 125V/250V/300V		●	○	○	○	○
315mA	DC 65V/125V AC 125V/250V/300V		●	○	○	○	○
400mA	DC 65V/125V AC 125V/250V/300V	UL:	●	○	○	○	○
500mA	DC 65V/125V AC 125V/250V/300V	65V/125V DC 100A	●	●	●	○	●
630mA	DC 65V/125V AC 125V/250V/300V	250V/300V AC 100A	●	○	○	○	○
750mA	DC 65V/125V AC 125V/250V/300V		●	○	○	○	○
800mA	DC 65V/125V AC 125V/250V/300V	TUV&CQC:	●	○	○	○	○
1A	DC 65V/125V AC 125V/250V/300V	规格≤3.15A	●	●	●	●	●
1.25A	DC 65V/125V AC 125V/250V/300V	125V DC 35A	●	●	●	●	●
1.6A	DC 65V/125V AC 125V/250V/300V	250V AC 35A	●	●	●	●	●
2A	DC 65V/125V AC 125V/250V/300V	规格>3.15A	●	●	●	●	●
2.5A	DC 65V/125V AC 125V/250V/300V	10 IN/125V DC	●	●	●	●	○
3A	DC 65V/125V AC 125V/250V/300V	10 IN/250V AC	●	○	○	○	○
3.15A	DC 65V/125V AC 125V/250V/300V		●	●	●	●	●
4A	DC 65V/125V AC 125V/250V/300V	PSE	●	●	●	●	●
4.5A	DC 65V/125V AC 125V/250V/300V	250V AC 100A	●	○	○	○	○
5A	DC 65V/125V AC 125V/250V/300V		●	●	●	●	●
6.3A	DC 65V/125V AC 125V/250V/300V	KC:	●	●	●	●	●
7A	DC 65V/125V AC 125V/250V/300V	规格≤3.15A	●	○	○	○	○
8A	DC 65V/125V AC 125V/250V/300V	250V AC 35A	●	●	●	●	●
10A	DC 65V/125V AC 125V/250V/300V	规格>3.15A	●	●	●	●	●
12A	DC 65V/125V AC 125V/250V/300V	10 IN/250V AC	●	○	○	○	○
12.5A	DC 65V/125V AC 125V/250V/300V		●	●	●	●	○
15A	DC 65V/125V AC 125V/250V/300V		●	●	●	●	○
16A	DC 65V/125V AC 125V/250V/300V		●	○	○	○	○
18A	DC 65V/125V AC 125V/250V/300V		●	○	○	○	○
20A	DC 65V/125V AC 125V/250V/300V		●	○	○	○	○
25A	DC 65V/125V AC 125V/250V/300V		●	○	○	○	○
30A	DC 65V/125V AC 125V/250V/300V		●	○	○	○	○

8-3 I-t图/CHARACTERISTICS DIAGRAM(I-t)

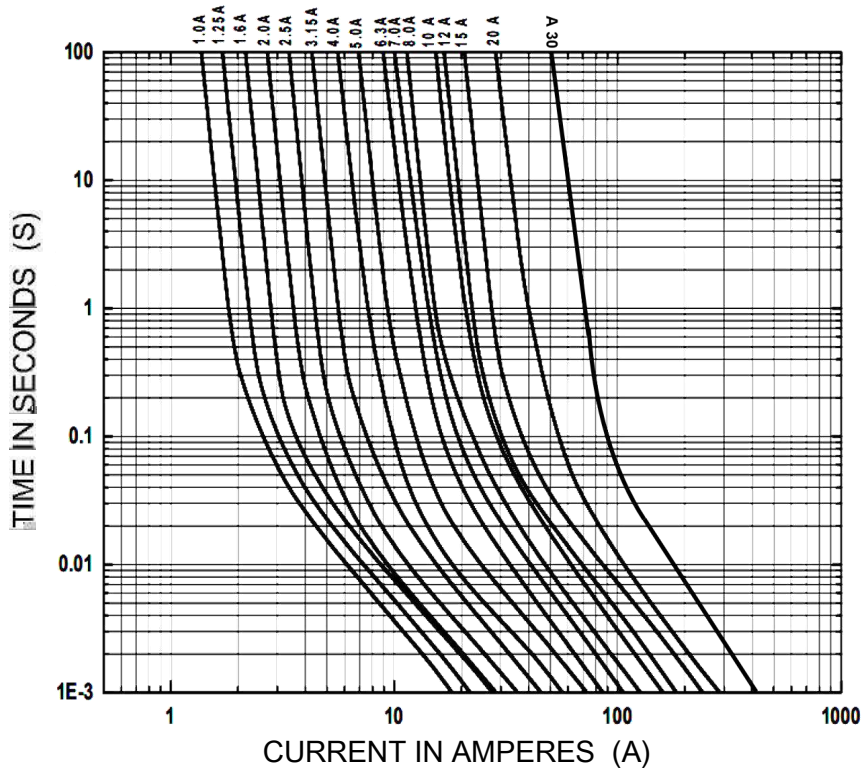

8-4 I²t-t图/CHARACTERISTICS DIAGRAM(I²t-t)

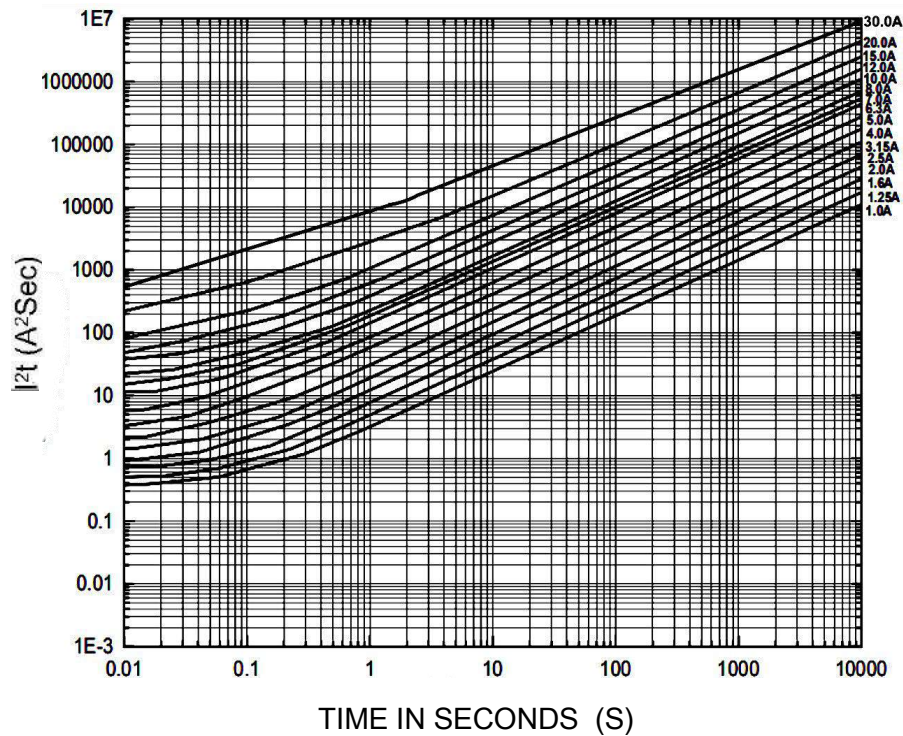

9. 环境特性 / ENVIRONMENTAL CHARACTERISTIC

操作温度范围: -55°C~125°C / Operating Temperature: -55°C~125°C

若贵司操作环境温度超出25±5°C范围, 在选用保险丝规格时, 需考虑操作环境温度对保险丝的影响。
请参照: 温度-电流曲线图。

When choosing the fuse's specification, if the operating environmental temperature beyond the scope from 20~30°C,
you Sould consider the environmental temperature's affection to fuses.
please refer:

Temperature-Current curve:

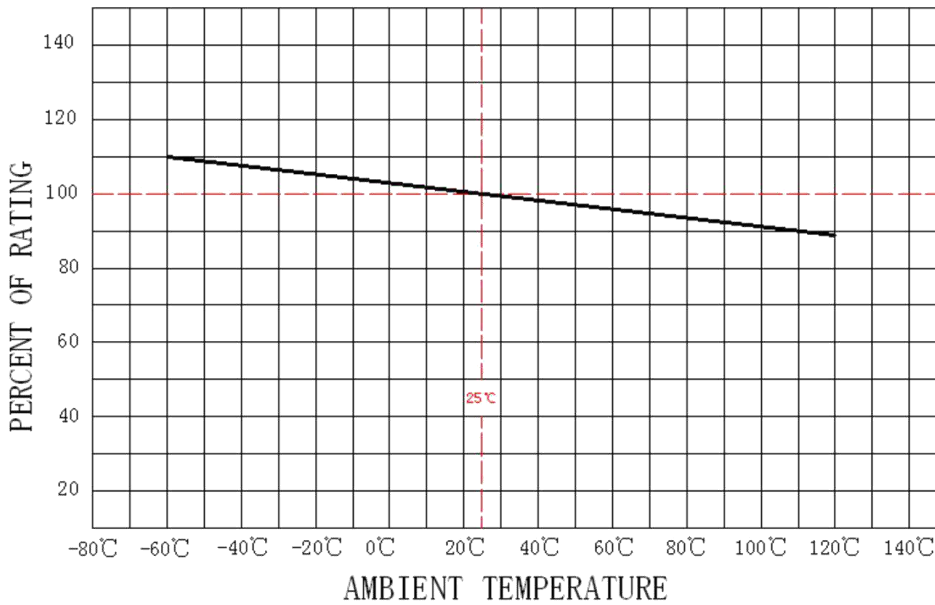

10. 安装方式及条件 / INSTALLATION WAY AND PARAMETERS

10-1 建议如下图安装方式安装 (含安装座), 并满足所要求的尺寸。
Propose that the following picture installation way is installed
(Including mounting base),
and satisfied the required size

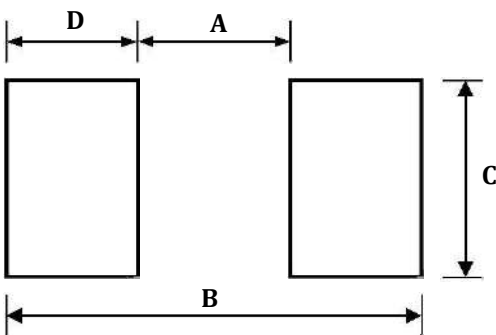

Dimensions	A (mm)	B (mm)	C (mm)	D (mm)
6125SB	3.00±0.30	8.00±0.30	3.00±0.30	2.50±0.30

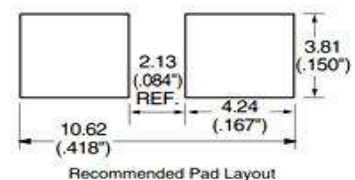
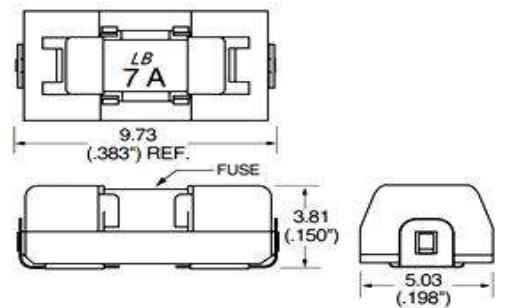

10-2 建议客户焊接参数 / Recommended Customer Soldering Parameters

1. Infrared Reflow:

Temperature: 260°C

Time: 5sec Max.

Recommend Reflow profile

Reflow Condition		Pb-Free assembly
Preheating	-Temperature Min (Ts(min))	150 °C
	-Temperature Max (Ts(max))	200 °C
	-Time	60~120 Secs
Soldering	-Temperature (TL)(Liquidus)	235 °C
	-Time Max (TL)	20~40Secs
	-Peak Temperature (Tp)	Max 260 °C
	-Time Max (Tp)	5 Secs

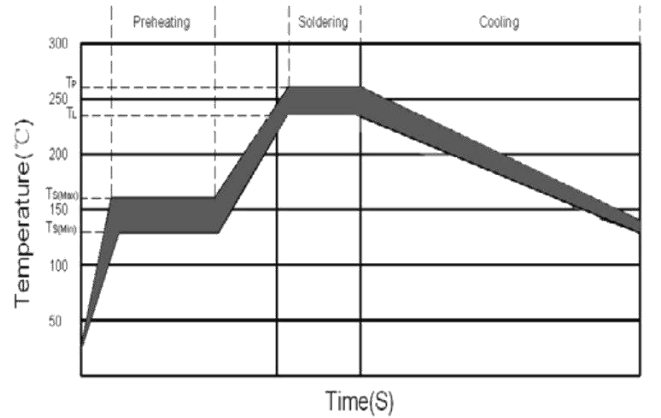

2. Wave soldering

Reservoir Temperature: 260°C

Time in Reservoir: 10sec Max.

3. Hand Soldering :

Temperature: 300°C

Time: 2sec Max.

Soldering iron avoid touch Brass Cap.

11. 其他使用注意事项 / OTHER NOTICE IN USED

符合本公司可能的其它文件的要求。

It could be in conformance with another file which made by our company.

12. 安全认证及编号 / STANDARDS AND APPROVALS

UL&C-UL	E213695
TUV	R504687690001
CQC	CQC20012246238
PSE	PSE21021896 (1A~5A) PSE21021895 (6.3A~15A)
KC	SU05063-21001 (1A~2.5A)
	SU05063-21002 (3.15~6.3A)
	SU05063-21003 (8A, 10A)
	SU05063-21004 (500mA)

13. 包装讯息 / PACKING INFORMATION

13-1 包装数量、重量 / QUANTITY & WEIGHT

型号 Type Number	数量(pcs) Quantity(pcs)
6125SB	1,000

13-2 卷轮规格/ Reel & Tape specifications

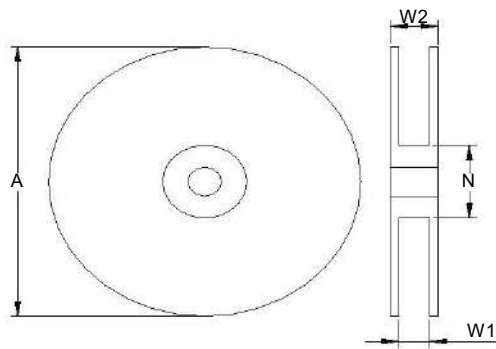

Unit(mm)

A ± 2	N ± 2	W1 ± 1	W2 ± 1.5
178	58	12.5	14.5

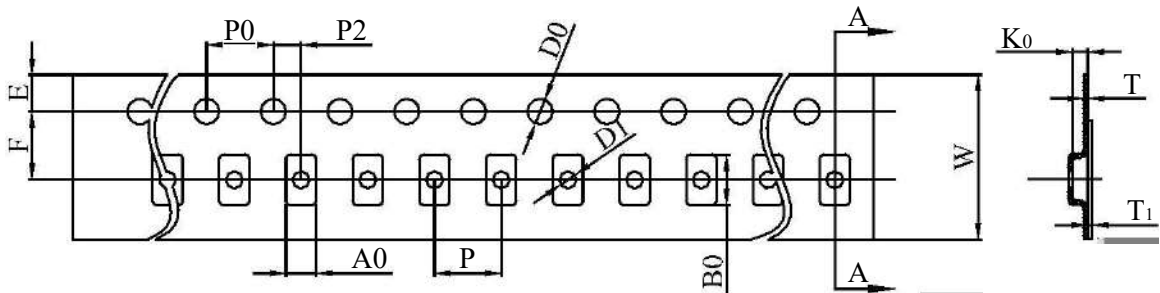

Unit(mm)

W	12.0 ± 0.15	D0	1.50 ± 0.10
P0	4.00 ± 0.10	F	5.50 ± 0.10
P	4.00 ± 0.10	E	1.75 ± 0.10
P2	2.00 ± 0.10	T	0.25 ± 0.05
A0	2.70 ± 0.10	T1	Max. 0.1
B0	6.40 ± 0.10	K0	2.70 ± 0.10

13-3 密封胶膜剥离强度要求 / Peeling Strength of Seal Tape

F = 剥离强度 : 0.1 – 1.0N (10 - 100gf)

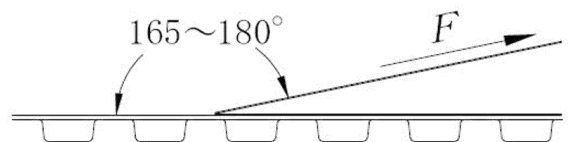

14. 其他 / OTHERS

14-1 如果在使用中有超出本规格书的要求，必须经由双方协商确认。

In the event that an impropriety is found beyond this specification ,it Sball be fixed by mutual agreement between the parties.

14-2 如果本规格书有不适当的情况，必须通过双方协商并由本公司修改。

In the event that an impropriety is found in this specification , LANBAO ELECTRICAL APPLIANCES CO. LTD. Sball amend it by mutual agreement between the parties.

版次	制作	确认	审核
第 1 版	赖秋莲 2020/11/20	谢海林 2020/11/20	熊士军 2020/11/20



UL iQ for Fuses



Fuses

E213695

Guide Information

ZHONG SHAN LANBAO ELECTRICAL APPLIANCES CO LTD

West Xing Pu Rd, Huang Pu, Zhongshan Guangdong 528429 CN

6125SB, 6125FA

Supplemental micro fuses: surface mount

<u>Size</u> mm(in)	<u>Amps</u> (A)	<u>Volts</u> (V)	<u>Interrupting</u> <u>Rating</u> (A)
6.5 x 2.8 x 2.8 (0.26 x 0.11 x 0.11)	0.05 - 30	300Vac	100
	0.05 - 30	250Vac	100
	0.05 - 30	125Vac	100
	0.05 - 30	125Vdc	100
	0.05 - 30	65Vdc	100

Report Date: 2019-08-15

Last Revised: 2019-08-21

© 2020 UL LLC



Zhongshan Lanbao Electrical
Appliances Co., Ltd.
Shijun Xiong

Date : 02.06.2020
Our ref. : YFC 05
Your ref.:

No.102 Xingpu Road, Huangpu Town
Zhongshan
528429 Guangdong
P.R. China

Ref : R TÜV-Mark Approval

Type of Equipment : Miniature fuse-links
Model Designation : See Certificate
Certificate No. : R 50468769 0001
Report No. : 60355661 001

Dear Shijun Xiong,

The above specified technical equipment has been tested and found to be in accordance with the relevant requirements.

Enclosed you will find the certificate of approval.

If cancellation of the certificate is submitted by November 15 in a given year, no fee will be charged for the following year.

We appreciate your kind support and would like to offer our assistance and continuous services in the future.

Please contact our office for approval of your new products.

With kind regards,

Certification Body

G. Yin

Enclosure

证书的详细资料请登陆www.tuvdotcom.com查阅,或拨打我司客服热线800 999 3668 / 400 883 1300咨询

Zertifikat

Certificate



Zertifikat Nr. *Certificate No.*
R 50468769

Blatt *Sheet*
0001

Ihr Zeichen *Client Reference*

Unser Zeichen *Our Reference*
05-YFC-60355661 001

Ausstellungsdatum
02.06.2020

Date of Issue
(day/mo/yr)

Genehmigungsinhaber *License Holder*

Zhongshan Lanbao Electrical
Appliances Co., Ltd.
No.102 Xingpu Road, Huangpu Town
Zhongshan
528429 Guangdong
P.R. China

Fertigungsstätte *Manufacturing Plant*

Zhongshan Lanbao Electrical
Appliances Co., Ltd.
No.102 Xingpu Road, Huangpu Town
Zhongshan
528429 Guangdong
P.R. China

Prüfzeichen *Test Mark*



Type Approved
Safety
Regular Production
Surveillance

www.tuv.com
ID 1111224142

Geprüft nach *Tested acc. to*

EN 60127-1:2006+A1+A2
EN 60127-7:2016
IEC 60127-1:2006+A1+A2
IEC 60127-7:2015

**Zertifiziertes Produkt (Geräteidentifikation)
*Certified Product (Product Identification)***

**Lizenzentgelte - Einheit
*License Fee - Unit***

Fuse Link (Miniature fuse-links)

Type Designation	: 6125SB 6125FA	15
Trademark	: LB	
Rated Voltage	: AC 250V, DC 125V	
Rated Current(In)	: 500mA; 1A; 1,25A; 1,6A; 2A; 2,5A 3,15A; 4A; 5A; 6,3A; 8A; 10A; 12,5A; 15A	
T/I Characteristic	: see appendix 1	
Rated Breaking Capacity	: 35A or 10In, whichever is greater	
Dimension	: 6,1mmx2,6mm, without pigtail	

Remark : The labelling requirements acc. to EU Directive 2001/95 have to be observed for distribution within the EEA. The installation has to be carried out according to installation instruction accompanying the products.

15

ANLAGE (Appendix): 1

Dem Zertifikat liegt unsere Prüf- und Zertifizierungsordnung zugrunde und es bestätigt die Konformität des Produktes mit den oben genannten Standards und Prüfgrundlagen. Zusätzliche Anforderungen in Ländern, in denen das Produkt in Verkehr gebracht werden soll, müssen zusätzlich betrachtet werden. Die Herstellung des zertifizierten Produktes wird überwacht.
This certificate is based on our Testing and Certification Regulation and states the conformity of the product with the standards and testing requirements as indicated above. Any additional requirements in countries where the product is going to be marketed have to be considered additionally. The manufacturing of the certified product is subject to surveillance.

TÜV Rheinland LGA Products GmbH, Tillystraße 2, 90431 Nürnberg

Tel.: +49 221 806-1371 e-mail: cert-validity@de.tuv.com
Fax: +49 221 806-3935 http://www.tuv.com/safety





产品认证证书

证书编号: CQC20012246238

申请人名称及地址

中山市蓝宝电器有限公司
中山市黄圃镇兴圃大道西 102 号之三

制造商名称及地址

中山市蓝宝电器有限公司
中山市黄圃镇兴圃大道西 102 号之三

生产企业名称及地址

中山市蓝宝电器有限公司 (V002199)
中山市黄圃镇兴圃大道西 102 号之三

产品名称和系列、规格、型号

特殊应用的小型熔断体

6125SB/6125FA 500mA a.c. 250V/d.c. 125V、6125SB/6125FA 1A a.c. 250V/d.c. 125V、6125SB/6125FA 1.25A a.c. 250V/d.c. 125V、6125SB/6125FA 1.6A a.c. 250V/d.c. 125V、6125SB/6125FA 2A a.c. 250V/d.c. 125V、6125SB/6125FA 2.5A a.c. 250V/d.c. 125V、6125SB/6125FA 3.15A a.c. 250V/d.c. 125V、6125SB/6125FA 4A a.c. 250V/d.c. 125V、6125SB/6125FA 5A a.c. 250V/d.c. 125V、6125SB/6125FA 6.3A a.c. 250V/d.c. 125V、6125SB/6125FA 8A a.c. 250V/d.c. 125V、6125SB/6125FA 10A a.c. 250V/d.c. 125V、6125SB/6125FA 12.5A a.c. 250V/d.c. 125V、6125SB/6125FA 15A a.c. 250V/d.c. 125V(额定分断能力: 35A 或 10In, 取较大值, 主要尺寸: 6.1mm×2.6mm×2.6mm)

产品标准和技术要求

GB/T 9364.1-2015; GB/T 9364.7-2016

认证模式

产品型式试验+获证后监督

上述产品符合 CQC11-462125-2018 认证规则的要求, 特发此证。

发证日期: 2020 年 05 月 12 日 有效期至: 2025 年 05 月 12 日

证书有效期内本证书的有效性依据发证机构的定期监督获得保持。

主任: _____

陆楠



中国质量认证中心

中国·北京·南四环西路 188 号 9 区 100070

<http://www.cqc.com.cn>

C 0256484



PRODUCT CERTIFICATE

CERTIFICATE NO.: CQC20012246238

NAME AND ADDRESS OF THE APPLICANT

Zhongshan Lanbao Electrical Appliances Co.,Ltd.
No.3, West 102, Xingpu Road, Huangpu Town, Zhongshan City, Guangdong Province

NAME AND ADDRESS OF THE MANUFACTURER

Zhongshan Lanbao Electrical Appliances Co.,Ltd.
No.3, West 102, Xingpu Road, Huangpu Town, Zhongshan City, Guangdong Province

NAME AND ADDRESS OF THE FACTORY

Zhongshan Lanbao Electrical Appliances Co.,Ltd. (V002199)
No.3, West 102, Xingpu Road, Huangpu Town, Zhongshan City, Guangdong Province

PRODUCT NAME, MODEL AND SPECIFICATION

Miniature fuse-links for special applications

6125SB/6125FA 500mA a.c. 250V/d.c. 125V、6125SB/6125FA 1A a.c. 250V/d.c. 125V、6125SB/6125FA 1.25A a.c. 250V/d.c. 125V、6125SB/6125FA 1.6A a.c. 250V/d.c. 125V、6125SB/6125FA 2A a.c. 250V/d.c. 125V、6125SB/6125FA 2.5A a.c. 250V/d.c. 125V、6125SB/6125FA 3.15A a.c. 250V/d.c. 125V、6125SB/6125FA 4A a.c. 250V/d.c. 125V、6125SB/6125FA 5A a.c. 250V/d.c. 125V、6125SB/6125FA 6.3A a.c. 250V/d.c. 125V、6125SB/6125FA 8A a.c. 250V/d.c. 125V、6125SB/6125FA 10A a.c. 250V/d.c. 125V、6125SB/6125FA 12.5A a.c. 250V/d.c. 125V、6125SB/6125FA 15A a.c. 250V/d.c. 125V(额定分断能力: 35A 或 10In, 取较大值, 主要尺寸:6.1mm×2.6mm×2.6mm)

THE STANDARDS AND TECHNICAL REQUIREMENTS FOR THE PRODUCTS

GB/T 9364.1-2015;GB/T 9364.7-2016

TYPE OF CERTIFICATION SCHEMES

Type Testing of Product + Follow up Factory Inspection

This is to certify that the above mentioned product(s) complies with the requirements of certification rules of CQC11-462125-2018 .

Valid from: May.12,2020

Valid until: May.12,2025

The validity of the certificate is subject to positive result of the regular follow up inspection by issuing certification body until the expiry date.

President: _____

Lu Mei



CHINA QUALITY CERTIFICATION CENTRE

Section 9, No.188, Nansihuan Xilu, Beijing 100070 P.R.China

<http://www.cqc.com.cn>

C 0256484



適合同等証明書

Statement of Conformity Assessment

証明書番号 Statement No.

PSE21021896

申請者照会番号 Applicant Reference

CJP2021102004-2357

発行年月日 Date of Issue

2021年6月2日

申請者 Applicant

ZHONGSHAN LANBAO ELECTRICAL
APPLIANCES CO., LTD.

NO.3, WEST 102, XINGPU ROAD, HUANGPU
TOWN, ZHONGSHAN CITY, GUANGDONG
PROVINCE, 528429, P. R. CHINA

製造工場 Factory

ZHONGSHAN LANBAO ELECTRICAL
APPLIANCES CO., LTD.

NO.3, WEST 102, XINGPU ROAD, HUANGPU
TOWN, ZHONGSHAN CITY, GUANGDONG
PROVINCE, 528429, P. R. CHINA

検査の方法 Technical standards

- 電気用品の技術上の基準を定める省令の解釈 別表第十二 国際規格等に準拠した基準
J60127-1(H28); J60127-4(H28)

- 施行規則別表第四

Appendix 4 of the Enforcement Regulations

特定電気用品名 :

Name of Specified Electrical
Appliance and Material

その他の包装ヒューズ

Other enclosed fuses

型式の区分 :

Type Classification

(「添付書類」参照)

(Refer to Attachment)

モデル名 :

6125SB/6125FA 1A a.c. 250V、6125SB/6125FA 1.25A a.c. 250V、
6125SB/6125FA 1.6A a.c. 250V、6125SB/6125FA 2A a.c. 250V、
6125SB/6125FA 2.5A a.c. 250V、6125SB/6125FA 3.15A a.c. 250V、
6125SB/6125FA 4A a.c. 250V、6125SB/6125FA 5A a.c. 250V

Model

証明書の有効期間 :

Validity of Statement

2028年6月1日まで有効です。

This statement will expire on Jun.1st,2028

電気用品安全法第8条第1項に規定する技術基準及び同法第9条第2項の経済産業省令で定める基準（法第9条第1項第2号に係る検査に係るものに限る）に適合していることを証明します

I hereby certify that the product mentioned above complies with the technical requirements stipulated in Paragraph 1 of Article 8 of Electrical Appliances and Materials Safety Act (here under referred to as the Act) and the requirements defined by the ordinance of the Ministry of Economy, Trade and Industry based on Paragraph 2 of Article 9 of the Act (limited to Item 2 of Paragraph 1 of Article 9 for Inspection of the Act).



氏名
Name

谢肇煦

発行者
Issued by



中国品質認証センター
CHINA QUALITY CERTIFICATION CENTRE



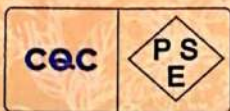

適合同等証明書

Statement of Conformity Assessment

添付書類 Attachment 1

証明書番号(Statement No.):

PSE21021896

発行日 Date of Issue:

2021年6月2日

【 型式の区分 Type Classification 】

特定電気用品:

(Name of Specified Electrical Appliance and Material)

その他の包装ヒューズ

Other enclosed fuses

要素	区分
定格電圧	(1) 125V以下のもの (2) 125Vを超えるもの
定格電流 (定格電流表示のあるものの場合に限る。)	(1) 5A以下のもの (2) 5Aを超え15A以下のもの (3) 15Aを超え30A以下のもの (4) 30Aを超え60A以下のもの (5) 60Aを超え100A以下のもの (6) 100Aを超えるもの
適用電動機の定格容量 (定格電流表示のないものの場合に限る。)	(1) 単相で200W以下のもの (2) 単相で200Wを超え400W以下のもの (3) 単相で400Wを超え750W以下のもの (4) 単相で750Wを超えるもの (5) 3相で750W以下のもの (6) 3相で750Wを超え2.2kW以下のもの (7) 3相で2.2kWを超え3.7kW以下のもの (8) 3相で3.7kWを超え7.5kW以下のもの (9) 3相で7.5kWを超えるもの
可溶体の主材料	(1) 銀のもの (2) アルミニウムのもの (3) 亜鉛のもの (4) 鉛のもの (5) 銅のもの (6) その他のもの

氏名
Name

谢肇煦

発行者
Issued by



中国品質認証センター
CHINA QUALITY CERTIFICATION CENTRE



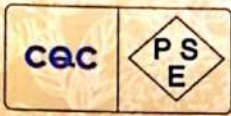

適合同等証明書

Statement of Conformity Assessment

添付書類 Attachment 2

証明書番号(Statement No.):

PSE21021896

発行日 Date of Issue :

2021年6月2日

【型式の区分 Type Classification】

特定電気用品:

(Name of Specified Electrical Appliance and Material)

その他の包装ヒューズ

Other enclosed fuses

可溶体の数	(1) 1のもの (2) 2以上のもの
再使用(管形ヒューズを除く。)	(1) できるもの (2) できないもの
内部充てん物	(1) あるもの (2) ないもの
筒(内筒を除く。)の材料	(1) フェノール樹脂のもの (2) ファイバーのもの (3) 磁器のもの又はガラスのもの (4) ポリエステル樹脂のもの (5) メラミン樹脂のもの (6) ユリア樹脂のもの (7) その他のもの
端子	(1) 刃形のもの (2) 筒形のもの (3) 締付け形のもの (4) リード線付きのもの (5) その他のもの
排気孔	(1) あるもの (2) ないもの
溶断の表示	(1) あるもの (2) ないもの
用途	(1) 電動機用のもの (2) 電子機器用のもの (3) 短絡保護専用のもの (4) その他のもの

氏名
Name

谢肇煦

発行者
Issued by



中国品質認証センター
CHINA QUALITY CERTIFICATION CENTRE



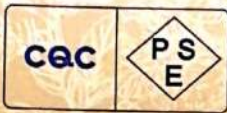

適合同等証明書

Statement of Conformity Assessment

添付書類 Attachment 3

証明書番号(Statement No.) :

PSE21021896

発行日 Date of Issue :

2021年6月2日

【型式の区分 Type Classification】

特定電気用品 :

(Name of Specified Electrical Appliance and Material)

その他の包装ヒューズ

Other enclosed fuses

定格遮断電流

- (1) 100A以下のもの
- (2) 100Aを超え300A以下のもの
- (3) 300Aを超え500A以下のもの
- (4) 500Aを超え1,000A以下のもの
- (5) 1,000Aを超え1,500A以下のもの
- (6) 1,500Aを超え2,500A以下のもの
- (7) 2,500Aを超え5,000A以下のもの
- (8) 5,000Aを超え7,500A以下のもの
- (9) 7,500Aを超え10,000A以下のもの
- (10) 10,000Aを超え15,000A以下のもの
- (11) 15,000Aを超え20,000A以下のもの
- (12) 20,000Aを超え25,000A以下のもの
- (13) 25,000Aを超え30,000A以下のもの
- (14) 30,000Aを超えるもの

氏名
Name

谢肇煦

発行者
Issued by



中国品質認証センター
CHINA QUALITY CERTIFICATION CENTRE



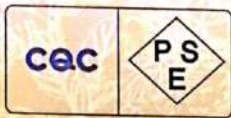

適合同等証明書

Statement of Conformity Assessment

証明書番号 Statement No.
PSE21021895

申請者照会番号 Applicant Reference
CJP2021102004-2365

発行年月日 Date of Issue
2021年6月2日

申請者 Applicant
ZHONGSHAN LANBAO ELECTRICAL
APPLIANCES CO., LTD.
NO.3, WEST 102, XINGPU ROAD, HUANGPU
TOWN, ZHONGSHAN CITY, GUANGDONG
PROVINCE, 528429, P. R. CHINA

製造工場 Factory
ZHONGSHAN LANBAO ELECTRICAL
APPLIANCES CO., LTD.
NO.3, WEST 102, XINGPU ROAD, HUANGPU
TOWN, ZHONGSHAN CITY, GUANGDONG
PROVINCE, 528429, P. R. CHINA

検査の方法 Technical standards

- 電気用品の技術上の基準を定める省令の解釈 別表第十二 国際規格等に準拠した基準
J60127-1(H28); J60127-4(H28)

- 施行規則別表第四

Appendix 4 of the Enforcement Regulations

特定電気用品名 : その他の包装ヒューズ
Name of Specified Electrical Appliance and Material Other enclosed fuses

型式の区分 : (「添付書類」参照)
Type Classification (Refer to Attachment)

モデル名 : 6125SB/6125FA 6.3A a.c. 250V、6125SB/6125FA 8A a.c. 250V、
6125SB/6125FA 10A a.c. 250V、6125SB/6125FA 12.5A a.c. 250V、
6125SB/6125FA 15A a.c. 250V

Model

証明書の有効期間 : 2028年6月1日まで有効です。
Validity of Statement This statement will expire on Jun.1st,2028

電気用品安全法第8条第1項に規定する技術基準及び同法第9条第2項の経済産業省令で定める基準（法第9条第1項第2号に係る検査に係るものに限る）に適合していることを証明します

I hereby certify that the product mentioned above complies with the technical requirements stipulated in Paragraph 1 of Article 8 of Electrical Appliances and Materials Safety Act (here under referred to as the Act) and the requirements defined by the ordinance of the Ministry of Economy, Trade and Industry based on Paragraph 2 of Article 9 of the Act (limited to Item 2 of Paragraph 1 of Article 9 for Inspection of the Act).



氏名
Name

谢肇煦

発行者
Issued by



中国品質認証センター
CHINA QUALITY CERTIFICATION CENTRE



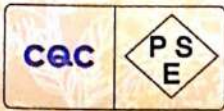

適合同等証明書

Statement of Conformity Assessment

添付書類 Attachment 1

証明書番号(Statement No.) :

PSE21021895

発行日 Date of Issue :

2021年6月2日

【 型式の区分 Type Classification 】

特定電気用品 :

(Name of Specified Electrical Appliance and Material)

その他の包装ヒューズ

Other enclosed fuses

要素	区分
定格電圧	(1) 125V以下のもの (2) 125Vを超えるもの
定格電流 (定格電流表示のあるものの場合に限る。)	(1) 5A以下のもの (2) 5Aを超え15A以下のもの (3) 15Aを超え30A以下のもの (4) 30Aを超え60A以下のもの (5) 60Aを超え100A以下のもの (6) 100Aを超えるもの
適用電動機の定格容量 (定格電流表示のないものの場合に限る。)	(1) 単相で200W以下のもの (2) 単相で200Wを超え400W以下のもの (3) 単相で400Wを超え750W以下のもの (4) 単相で750Wを超えるもの (5) 3相で750W以下のもの (6) 3相で750Wを超え2.2kW以下のもの (7) 3相で2.2kWを超え3.7kW以下のもの (8) 3相で3.7kWを超え7.5kW以下のもの (9) 3相で7.5kWを超えるもの
可溶体の主材料	(1) 銀のもの (2) アルミニウムのもの (3) 亜鉛のもの (4) 鉛のもの (5) 銅のもの (6) その他のもの

氏名
Name

谢肇煦

発行者
Issued by



中国品質認証センター
CHINA QUALITY CERTIFICATION CENTRE





適合同等証明書

Statement of Conformity Assessment

添付書類 Attachment 2

証明書番号(Statement No.):
PSE21021895

発行日 Date of Issue :
2021年6月2日

【 型式の区分 Type Classification 】

特定電気用品 :
(Name of Specified Electrical Appliance and Material)

その他の包装ヒューズ
Other enclosed fuses

可溶体の数	(1) 1のもの (2) 2以上のもの
再使用 (管形ヒューズを除く。)	(1) できるもの (2) できないもの
内部充てん物	(1) あるもの (2) ないもの
筒 (内筒を除く。) の材料	(1) フェノール樹脂のもの (2) ファイバーのもの (3) 磁器のもの又はガラスのもの (4) ポリエステル樹脂のもの (5) メラミン樹脂のもの (6) ユリア樹脂のもの (7) その他のもの
端子	(1) 刃形のもの (2) 筒形のもの (3) 締付け形のもの (4) リード線付きのもの (5) その他のもの
排気孔	(1) あるもの (2) ないもの
溶断の表示	(1) あるもの (2) ないもの
用途	(1) 電動機用のもの (2) 電子機器用のもの (3) 短絡保護専用のもの (4) その他のもの

氏名
Name

谢肇煦

発行者
Issued by



中国品質認証センター
CHINA QUALITY CERTIFICATION CENTRE



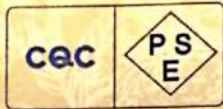

適合同等証明書

Statement of Conformity Assessment

添付書類 Attachment 3

証明書番号(Statement No.) :
PSE21021895

発行日 Date of Issue :
2021年6月2日

【型式の区分 Type Classification】

特定電気用品 :
(Name of Specified Electrical Appliance and Material)

その他の包装ヒューズ
Other enclosed fuses

定格遮断電流

- (1) 100A以下のもの
- (2) 100Aを超え300A以下のもの
- (3) 300Aを超え500A以下のもの
- (4) 500Aを超え1,000A以下のもの
- (5) 1,000Aを超え1,500A以下のもの
- (6) 1,500Aを超え2,500A以下のもの
- (7) 2,500Aを超え5,000A以下のもの
- (8) 5,000Aを超え7,500A以下のもの
- (9) 7,500Aを超え10,000A以下のもの
- (10) 10,000Aを超え15,000A以下のもの
- (11) 15,000Aを超え20,000A以下のもの
- (12) 20,000Aを超え25,000A以下のもの
- (13) 25,000Aを超え30,000A以下のもの
- (14) 30,000Aを超えるもの

氏名
Name

謝肇煦

発行者
Issued by



中国品質認証センター
CHINA QUALITY CERTIFICATION CENTRE



접 수 번 호 : 21-035920-04-1
(Receipt No.)



안 전 인 증 서

Safety Certificate

안 전 인 증 번 호 : SU05063-21004
(Certificate No.)

제 조 업 자/수 입 업 자 명 : Zhongshan Lanbao Electrical Appliances Co., Ltd.
(Manufacturer/importer)

주 소 : No.3, West 102, Xingpu Road, Huangpu Town, Zhongshan City,
(Address) Guangdong Province, 528429, P. R. China

제 품 명 : 퓨즈(Sub-miniature fuse-links)
(Product)

기 본 모 델 명 : 6125SB/6125FA 500mA a.c. 250V
(Basic Model)

파 생 모 델 명 : Not Applicable
(Series Model)

정 격/안 전 기 준 상 의 모 델 구 분 : AC250 V, 500 mA
(Rating)

시 험 기 준 : K60127-1(2011-12), KC60127-3(2015-09), IEC60127-7(2015)
(Standard)

본 인증서는 제조국명 : 중국
제조업자명 : Zhongshan Lanbao Electrical Appliances Co., Ltd.
제조공장의 주소 : No.3, West 102, Xingpu Road, Huangpu Town, Zhongshan City,
Guangdong Province, 528429, P. R. China
의 제품에만 해당함

「전기용품 및 생활용품 안전관리법 시행규칙」 제9조제2항, 제4항, 제10조제2항 또는 제15조제2항에 따라 안전인증서를 발급합니다.

We Issue This Safety Certificate for the above appliances in accordance with the Article 9(2),9(4),10(2) or 15(2) of the Enforcement Rule of the Electrical Appliances and Consumer Products Safety Control Act.

2021 년 06 월 23 일
Year month day

한국산업기술시험원장
KOREA TESTING LABORATORY



* 이 인증서는 「전기용품 및 생활용품 안전관리법 시행규칙」에 따른 제품의 안전성 확인에 한정된 것이며, 그 밖의 다른 법률이 적용되는 제품의 경우에는 해당 법률에 따라 추가로 인증·허가 등을 받아야 합니다.

첨부서류

1. 전기용품의 안전관리부품 및 재질목록(List of Critical Components)
2. 기본모델·파생모델의 내용 (Descriptions of the basic and series model)
3. 안전인증의 변경 현황 (Revisions Status)

첨부 1 : 전기용품의 안전관리부품 및 재질목록
List of Critical Components

부품명(회로기호) Component(Part no.)	제조사(상표명) Manufacturer(Brand)	모델명(형식) Model(Type)	정격 또는 특성 Rating or Characteristics	인증마크 Tested by
End cap	DONGGUAN FUSHI HARDWARE CO.,LTD.	-	Silver plated brass	-
Ceramic tube	Xinhua jinyi ceramic co. LTD	-	Ceramic	-
Fuse element	DONGGUAN DALINSHAN JINO HARDWARE FACTORY	-	TIN-SILVER-COPPER ALLOY	-

유의사항 (Attention) :

1. 안전관리부품은 전기적인 안전에 직접적인 영향을 주는 부품으로서 안전인증기관이 정기공장검사 시 확인 관리 하는 사항입니다. 따라서 상기목록에 기재된 사항을 변경하거나 또는 복수등재를 원하시는 경우는 안전인증기관에 인증변경신청을 하여야 합니다.

As the "Critical components" are parts in directly related with safety, these components shall be checked during a factory inspection by the certification body. In case of applying multiple listing or changing the items above, the certification revision shall be applied.

2. 인증변경신청 없이 임의로 변경하는 경우는, 전기용품 및 생활용품 안전관리법 시행규칙 제 21 조제 1 항 또는 제 38 조제 1 항 규정에 의한 안전인증 취소 혹은 안전확인신고 효력상실 사유가 됨을 유의하시기 바랍니다.

The Safety Certification will be cancelled under the Article 21(1), 38(1) of the Enforcement Rule of the Electrical appliances and Consumer Products Safety Control Act if the contents of the Certification is altered without our authorization.

첨부 2 : 기본모델 · 파생모델의 내용
Description of the basic and series model

파생모델명 Derivative model	기본모델과의 차이점 Differences between the basic and derivative model(s)
Not applicable	
제품특기사항 및 시험조건 Remarks & Test conditions	
<p>1. Review report No.: 21-035920-04-2</p> <p>2. Product Description</p> <ul style="list-style-type: none"> - a.c 250 V, 500 mA, Fuse-links for special applications - Rated breaking capacity: 35 A - Standard sheet 1 (IEC 60127-7 ed2: 2015) 	
<p><input type="checkbox"/> 본 제품의 검토내용에 관하여 문의하실 사항이 있으시면 아래 연락처로 문의하시기 바랍니다. 검토담당자 / 연락처 : BK 전략본부 인증관리센터 박종구 / (02)860-1470</p> <p><input type="checkbox"/> <i>If you have any question on product review, please contact the person below :</i> <i>Job holder : BK Strategy Division Certification Management Center, J.K.PARK/+82 2 8601-470</i></p>	

FP511-05

첨부 3 : 안전인증의 변경 현황
Revisions Status

변경발급 내용 Contents of Certificate Revisions
Not applicable

FP511-06

접 수 번 호 : 21-035920-01-1
(Receipt No.)



안 전 인 증 서

Safety Certificate

안 전 인 증 번 호 : SU05063-21001
(Certificate No.)

제 조 업 자/수 입 업 자 명 : Zhongshan Lanbao Electrical Appliances Co., Ltd.
(Manufacturer/importer)

주 소 : No.3, West 102, Xingpu Road, Huangpu Town, Zhongshan City,
(Address) Guangdong Province, 528429, P. R. China

제 품 명 : 퓨즈(Sub-miniature fuse-links)
(Product)

기 본 모 델 명 : 6125SB/6125FA 2.5A a.c. 250V
(Basic Model)

파 생 모 델 명 : See the attachment 2
(Series Model)

정 격/안 전 기 준 상 의 모 델 구 분 : AC250V, 2.5A
(Rating)

시 험 기 준 : K60127-1(2011-12), KC60127-3(2015-09), IEC60127-7(2015)
(Standard)

본 인증서는 제조국명 : 중국
제조업자명 : Zhongshan Lanbao Electrical Appliances Co., Ltd.
제조공장의 주소 : No.3, West 102, Xingpu Road, Huangpu Town, Zhongshan City,
Guangdong Province, 528429, P. R. China
의 제품에만 해당함

「전기용품 및 생활용품 안전관리법 시행규칙」 제9조제2항, 제4항, 제10조제2항 또는 제15조제2항에 따라 안전인증서를 발급합니다.

We Issue This Safety Certificate for the above appliances in accordance with the Article 9(2),9(4),10(2) or 15(2) of the Enforcement Rule of the Electrical Appliances and Consumer Products Safety Control Act.

2021 년 06 월 22 일
Year month day

한국산업기술시험원장
KOREA TESTING LABORATORY



* 이 인증서는 「전기용품 및 생활용품 안전관리법 시행규칙」에 따른 제품의 안전성 확인에 한정된 것이며, 그 밖의 다른 법률이 적용되는 제품의 경우에는 해당 법률에 따라 추가로 인증·허가 등을 받아야 합니다.

첨부서류

1. 전기용품의 안전관리부품 및 재질목록(List of Critical Components)
2. 기본모델·파생모델의 내용 (Descriptions of the basic and series model)
3. 안전인증의 변경 현황 (Revisions Status)

첨부 1 : 전기용품의 안전관리부품 및 재질목록
List of Critical Components

부품명(회로기호) Component(Part no.)	제조사(상표명) Manufacturer(Brand)	모델명(형식) Model(Type)	정격 또는 특성 Rating or Characteristics	인증마크 Tested by
End cap	DONGGUAN FUSHI HARDWARE CO.,LTD.	-	Silver plated brass	-
Ceramic tube	Xinhua jinyi ceramic co. LTD	-	Ceramic	-
Fuse element	DONGGUAN DALINSHAN JINO HARDWARE FACTORY	-	TIN-SILVER-COPPER ALLOY	-

유의사항 (Attention) :

1. 안전관리부품은 전기적인 안전에 직접적인 영향을 주는 부품으로서 안전인증기관이 정기공장검사 시 확인 관리 하는 사항입니다. 따라서 상기목록에 기재된 사항을 변경하거나 또는 복수등재를 원하시는 경우는 안전인증기관에 인증변경신청을 하여야 합니다.

As the "Critical components" are parts in directly related with safety, these components shall be checked during a factory inspection by the certification body. In case of applying multiple listing or changing the items above, the certification revision shall be applied.

2. 인증변경신청 없이 임의로 변경하는 경우는, 전기용품 및 생활용품 안전관리법 시행규칙 제 21 조제 1 항 또는 제 38 조제 1 항 규정에 의한 안전인증 취소 혹은 안전확인신고 효력상실 사유가 됨을 유의하시기 바랍니다.

The Safety Certification will be cancelled under the Article 21(1), 38(1) of the Enforcement Rule of the Electrical appliances and Consumer Products Safety Control Act if the contents of the Certification is altered without our authorization.

첨부 2 : 기본모델 · 파생모델의 내용
Description of the basic and series model

파생모델명 Derivative model	기본모델과의 차이점 Differences between the basic and derivative model(s)
6125SB/6125FA 2A a.c. 250V	The Current is different it' s 2A
6125SB/6125FA 1.6A a.c. 250V	The Current is different it' s 1.6A
6125SB/6125FA 1.25A a.c. 250V	The Current is different it' s 1.25A
6125SB/6125FA 1A a.c. 250V	The Current is different it' s 1A
제품특기사항 및 시험조건 Remarks & Test conditions	
<p>1. Review report No.: 21-035920-01-2</p> <p>2. Product Description</p> <ul style="list-style-type: none"> - a.c 250 V, 2.5 A, Fuse-links for special applications - Rated breaking capacity: 35 A - Standard sheet 1 (IEC 60127-7 ed2: 2015) 	
<p><input type="checkbox"/> 본 제품의 검토내용에 관하여 문의하실 사항이 있으시면 아래 연락처로 문의하시기 바랍니다. 검토담당자 / 연락처 : BK 전략본부 인증관리센터 박종구 / (02)860-1470</p> <p><input type="checkbox"/> <i>If you have any question on product review, please contact the person below :</i> <i>Job holder : BK Strategy Division Certification Management Center, J.K.PARK/+82 2 8601-470</i></p>	

FP511-05

첨부 3 : 안전인증의 변경 현황
Revisions Status

변경발급 내용 Contents of Certificate Revisions
Not applicable

FP511-06

접수번호 : 21-035920-02-1
(Receipt No.)



안전인증서

Safety Certificate

안전인증번호 : SU05063-21002
(Certificate No.)

제조사/수입업자명 : Zhongshan Lanbao Electrical Appliances Co., Ltd.
(Manufacturer/importer)

주소 : No.3, West 102, Xingpu Road, Huangpu Town, Zhongshan City,
(Address) Guangdong Province, 528429, P. R. China

제품명 : 퓨즈(Sub-miniature fuse-links)
(Product)

기본모델명 : 6125SB/6125FA 6.3A a.c. 250V
(Basic Model)

파생모델명 : See the attachment 2
(Series Model)

정격/안전기준상의 모델구분 : AC250 V, 6.3 A
(Rating)

시험기준 : K60127-1(2011-12), KC60127-3(2015-09), IEC60127-7(2015)
(Standard)

본 인증서는 제조국명 : 중국
제조사명 : Zhongshan Lanbao Electrical Appliances Co., Ltd.
제조공장의 주소 : No.3, West 102, Xingpu Road, Huangpu Town, Zhongshan City,
y, Guangdong Province, 528429, P. R. China
의 제품에만 해당함

「전기용품 및 생활용품 안전관리법 시행규칙」 제9조제2항, 제4항, 제10조제2항 또는 제15조제2항에 따라 안전인증서를 발급합니다.

We Issue This Safety Certificate for the above appliances in accordance with the Article 9(2),9(4),10(2) or 15(2) of the Enforcement Rule of the Electrical Appliances and Consumer Products Safety Control Act.

2021년 06월 22일
Year month day

한국산업기술시험원장
KOREA TESTING LABORATORY



* 이 인증서는 「전기용품 및 생활용품 안전관리법 시행규칙」에 따른 제품의 안전성 확인에 한정된 것이며, 그 밖의 다른 법률이 적용되는 제품의 경우에는 해당 법률에 따라 추가로 인증·허가 등을 받아야 합니다.

첨부서류

1. 전기용품의 안전관리부품 및 재질목록(List of Critical Components)
2. 기본모델·파생모델의 내용 (Descriptions of the basic and series model)
3. 안전인증의 변경 현황 (Revisions Status)

첨부 1 : 전기용품의 안전관리부품 및 재질목록
List of Critical Components

부품명(회로기호) Component(Part no.)	제조사(상표명) Manufacturer(Brand)	모델명(형식) Model(Type)	정격 또는 특성 Rating or Characteristics	인증마크 Tested by
End cap	DONGGUAN FUSHI HARDWARE CO.,LTD.	-	Silver plated brass	-
Ceramic tube	Xinhua jinyi ceramic co. LTD	-	Ceramic	-
Fuse element	DONGGUAN DALINSHAN JINO HARDWARE FACTORY	-	TIN-SILVER-COPPER ALLOY	-

유의사항 (Attention) :

1. 안전관리부품은 전기적인 안전에 직접적인 영향을 주는 부품으로서 안전인증기관이 정기공장검사 시 확인 관리 하는 사항입니다. 따라서 상기목록에 기재된 사항을 변경하거나 또는 복수등재를 원하시는 경우는 안전인증기관에 인증변경신청을 하여야 합니다.

As the "Critical components" are parts in directly related with safety, these components shall be checked during a factory inspection by the certification body. In case of applying multiple listing or changing the items above, the certification revision shall be applied.

2. 인증변경신청 없이 임의로 변경하는 경우는, 전기용품 및 생활용품 안전관리법 시행규칙 제 21 조제 1 항 또는 제 38 조제 1 항 규정에 의한 안전인증 취소 혹은 안전확인신고 효력상실 사유가 됨을 유의하시기 바랍니다.

The Safety Certification will be cancelled under the Article 21(1), 38(1) of the Enforcement Rule of the Electrical appliances and Consumer Products Safety Control Act if the contents of the Certification is altered without our authorization.

FP511-04

첨부 2 : 기본모델 · 파생모델의 내용
Description of the basic and series model

파생모델명 Derivative model	기본모델과의 차이점 Differences between the basic and derivative model(s)
6125SB/6125FA 5A a.c. 250V	The Current is different it' s 5A and breaking capacity is 50A
6125SB/6125FA 4A a.c. 250V	The Current is different it' s 4A and breaking capacity is 40A
6125SB/6125FA 3.15A a.c. 250V	The Current is different it' s 3.15A and breaking Capacity is 35A
제품특기사항 및 시험조건 Remarks & Test conditions	
<p>1. Review report No.: 21-035920-02-2</p> <p>2. Product Description</p> <ul style="list-style-type: none"> - a.c 250 V, 6.3 A, Fuse-links for special applications - Rated breaking capacity: 63 A - Standard sheet 1 (IEC 60127-7 ed2: 2015) 	
<p><input type="checkbox"/> 본 제품의 검토내용에 관하여 문의하실 사항이 있으시면 아래 연락처로 문의하시기 바랍니다. 검토담당자 / 연락처 : BK 전략본부 인증관리센터 박종구 / (02)860-1470</p> <p><input type="checkbox"/> <i>If you have any question on product review, please contact the person below :</i> <i>Job holder : BK Strategy Division Certification Management Center, J.K.PARK/+82 2 8601-470</i></p>	

FP511-05

첨부 3 : 안전인증의 변경 현황
Revisions Status

변경발급 내용 Contents of Certificate Revisions
Not applicable

FP511-06

접수번호 : 21-035920-03-1
(Receipt No.)



안전인증서

Safety Certificate

안전인증번호 : SU05063-21003
(Certificate No.)

제조사/수입업자명 : Zhongshan Lanbao Electrical Appliances Co., Ltd.
(Manufacturer/importer)

주소 : No.3, West 102, Xingpu Road, Huangpu Town, Zhongshan City,
(Address) Guangdong Province, 528429, P. R. China

제품명 : 퓨즈(Sub-miniature fuse-links)
(Product)

기본모델명 : 6125SB/6125FA 10A a.c. 250V
(Basic Model)

파생모델명 : 6125SB/6125FA 8A a.c. 250V
(Series Model)

정격/안전기준상의 모델구분 : AC250 V, 10 A
(Rating)

시험기준 : K60127-1(2011-12), KC60127-3(2015-09), IEC60127-7(2015)
(Standard)

본 인증서는 제조국명 : 중국
제조사명 : Zhongshan Lanbao Electrical Appliances Co., Ltd.
제조공장의 주소 : No.3, West 102, Xingpu Road, Huangpu Town, Zhongshan City,
y, Guangdong Province, 528429, P. R. China
의 제품에만 해당함

「전기용품 및 생활용품 안전관리법 시행규칙」 제9조제2항, 제4항, 제10조제2항 또는 제15조제2항에 따라 안전인증서를 발급합니다.

We Issue This Safety Certificate for the above appliances in accordance with the Article 9(2),9(4),10(2) or 15(2) of the Enforcement Rule of the Electrical Appliances and Consumer Products Safety Control Act.

2021 년 06 월 23 일
Year month day

한국산업기술시험원장
KOREA TESTING LABORATORY



* 이 인증서는 「전기용품 및 생활용품 안전관리법 시행규칙」에 따른 제품의 안전성 확인에 한정된 것이며, 그 밖의 다른 법률이 적용되는 제품의 경우에는 해당 법률에 따라 추가로 인증·허가 등을 받아야 합니다.

첨부서류

1. 전기용품의 안전관리부품 및 재질목록(List of Critical Components)
2. 기본모델·파생모델의 내용 (Descriptions of the basic and series model)
3. 안전인증의 변경 현황 (Revisions Status)

첨부 1 : 전기용품의 안전관리부품 및 재질목록
List of Critical Components

부품명(회로기호) Component(Part no.)	제조사(상표명) Manufacturer(Brand)	모델명(형식) Model(Type)	정격 또는 특성 Rating or Characteristics	인증마크 Tested by
End cap	DONGGUAN FUSHI HARDWARE CO.,LTD.	-	Silver plated brass	-
Ceramic tube	Xinhua jinyi ceramic co. LTD	-	Ceramic	-
Fuse element	DONGGUAN DALINSHAN JINO HARDWARE FACTORY	-	TIN-SILVER-COPPER ALLOY	-

유의사항 (Attention) :

1. 안전관리부품은 전기적인 안전에 직접적인 영향을 주는 부품으로서 안전인증기관이 정기공장검사 시 확인 관리 하는 사항입니다. 따라서 상기목록에 기재된 사항을 변경하거나 또는 복수등재를 원하시는 경우는 안전인증기관에 인증변경신청을 하여야 합니다.

As the "Critical components" are parts in directly related with safety, these components shall be checked during a factory inspection by the certification body. In case of applying multiple listing or changing the items above, the certification revision shall be applied.

2. 인증변경신청 없이 임의로 변경하는 경우는, 전기용품 및 생활용품 안전관리법 시행규칙 제 21 조제 1 항 또는 제 38 조제 1 항 규정에 의한 안전인증 취소 혹은 안전확인신고 효력상실 사유가 됨을 유의하시기 바랍니다.

The Safety Certification will be cancelled under the Article 21(1), 38(1) of the Enforcement Rule of the Electrical appliances and Consumer Products Safety Control Act if the contents of the Certification is altered without our authorization.

첨부 2 : 기본모델 · 파생모델의 내용
Description of the basic and series model

파생모델명 Derivative model	기본모델과의 차이점 Differences between the basic and derivative model(s)
6125SB/6125FA 8A a.c. 250V	The Current is different. it' s 8A and rated breaking capacity is 80A
제품특기사항 및 시험조건 Remarks & Test conditions	
<p>1. Review report No.: 21-035920-03-2</p> <p>2. Product Description</p> <ul style="list-style-type: none"> - a.c 250 V, 10 A, Fuse-links for special applications - Rated breaking capacity: 100 A - Standard sheet 1 (IEC 60127-7 ed2: 2015) 	
<p><input type="checkbox"/> 본 제품의 검토내용에 관하여 문의하실 사항이 있으시면 아래 연락처로 문의하시기 바랍니다. 검토담당자 / 연락처 : BK 전략본부 인증관리센터 박종구 / (02)860-1470</p> <p><input type="checkbox"/> <i>If you have any question on product review, please contact the person below :</i> <i>Job holder : BK Strategy Division Certification Management Center, J.K.PARK/+82 2 8601-470</i></p>	

FP511-05

첨부 3 : 안전인증의 변경 현황
Revisions Status

변경발급 내용 Contents of Certificate Revisions
Not applicable

FP511-06