

1. 适用范围 / SCOPE

此份规格书仅涵盖1206TDF系列产品.

This specification covers 1206TD series devices, which is SMD Fuse.

2. 产品名称及编码 / TYPE NUMBER & PART NUMBER

产品名称/ TYPE NUMBER

1206TD	****A	****V
1	2	3

- (1) 系列号: 1206TD (尺寸: 0.12×0.06; 熔断特性:快断)
Series Number: 1206TD (Size: 0.12×0.06; Melting characteristic: Fast Acting)
- (2) 额定电流: (例如:3.5A=3.5 安培)
Rating Current : (Ex. :3.5A = 3.5 Ampere)
- (3) 额定电压: (例如:63V=63 伏特)
Rating Voltage : (Ex. :63V = 63 Volt)

3. 产品尺寸和结构 / SIZE AND STRUCTURE

3-1 尺寸 (单位: mm) / SIZE (Unit: mm)

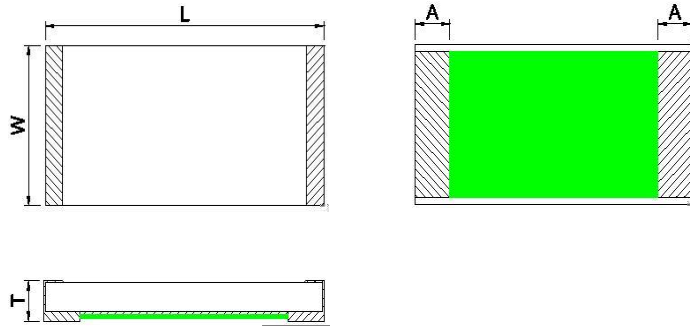

型号 / Type	w	L	T	A
1206TD****A***V	1.60±0.2	3.20±0.20	0.65±0.20	0.5±0.2

3-2 产品结构及使用材料说明 / STRUCTURE & MATERIAL

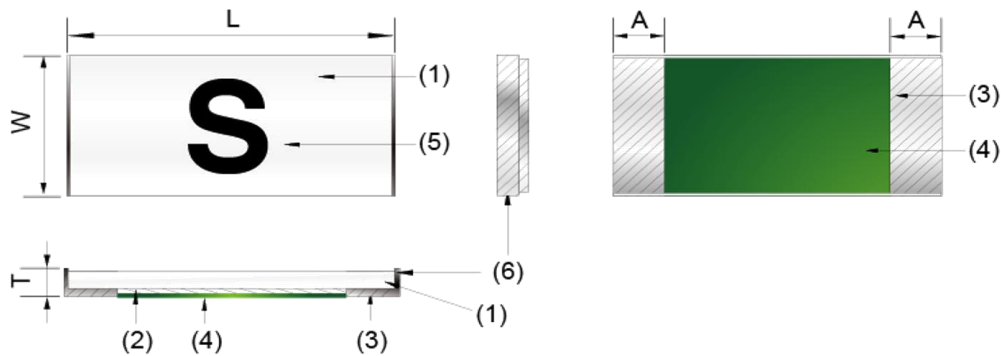

编码 No.	元件 Component	材质 Material	数量 Quantity
(1)	基板 Substrate	氧化铝陶瓷 Alumina Ceramic	1
(2)	涂层 Coating	玻璃 Glass	1
(3)	熔丝 Fuse element	银 Silver	1
(4)	保护层 Protective layer	玻璃 Glass	1
(5)	标识 Marking	玻璃 Glass	1
(6)	端电极 Terminal electrode	银/镍/锡 Ag / Ni / Sn	2

4. 基本信息/ ORDERING INFORMATION

Part NO. 料号	Rated voltage 额定电压 (DC)	Rated Current 额定电 流 (A)	Breaking Capacity 分断电流	Typical Cold Resistance (mOhms) ² 标准冷电阻	Typical Pre-Arcing I ² T (A ² Sec) 熔化热值	Marking 标记
1206TD630mA	24VDC 32VDC 36VDC 48VDC 63VDC 72VDC 125VDC 125VAC	0.63	48VDC@200A 125VDC@50A 125VAC@50A	1080	0.0004	B
1206TD750mA		0.75		850	0.0057	.75
1206TD1A		1		480	0.1	H
1206TD1.5A		1.5		230	0.15	K
1206TD2A		2		135	0.41	N
1206TD2.5A		2.5		75	0.65	O
1206TD3A		3		47	1.39	P
1206TD3.5A		3.5		38	1.68	R
1206TD4A		4		34	1.73	S
1206TD4.5A		4.5		29	2.62	X
1206TD5A		5		24	2.89	T
1206TD6A		6		16	11	F
1206TD7A		7		12.3	12.5	7
1206TD8A		8		8	14	M
1206TD10A		10		6.5	20	U
1206TD12A	24VDC 32VDC 36VDC 48VDC	12	48VDC@200A	5	11.5	12
1206TD15A		15		3.7	16.5	15
1206TD20A		20		2.4	47.17	Q
1206TD25A		25		1.6	32	L
1206TD30A		30		1.30	43	Z
1206TD40A	24/32/36VDC	40	36VDC@200A	0.85	160	XL

说明/Notes :

- a. “典型电阻”是在通以小于额定电流的 10%的弱电流条件下量测的阻抗。
Nominal Resistance measured with < 10% rated current ;
- b. “典型 I²t ”是指自通电至作动时间为 8ms 的过程所对应的 I²t。
Nominal Melting I²t measured at 8 m sec opening time ;
- b. 标准冷电阻公差范围+/-25%. Standard cold resistance tolerance range +/-25% ;
- c.

5. 电气特性 / ELECTRICAL CHARACTERISTICS

5-1 时间-电流特性/ Pre-Arcing Time-Current Characteristics (limits)

RATED CURRENT	1.0 IN/倍	2.0 IN/倍		3.5 IN/倍
250mA to 40A	Min	Min	Max	Max
	4 hrs	1s	120s	3s

In : 25°C下额定电流 / Rating Current at 25°C

5-2 时间-电流特性曲线 / Time-Current Curve:

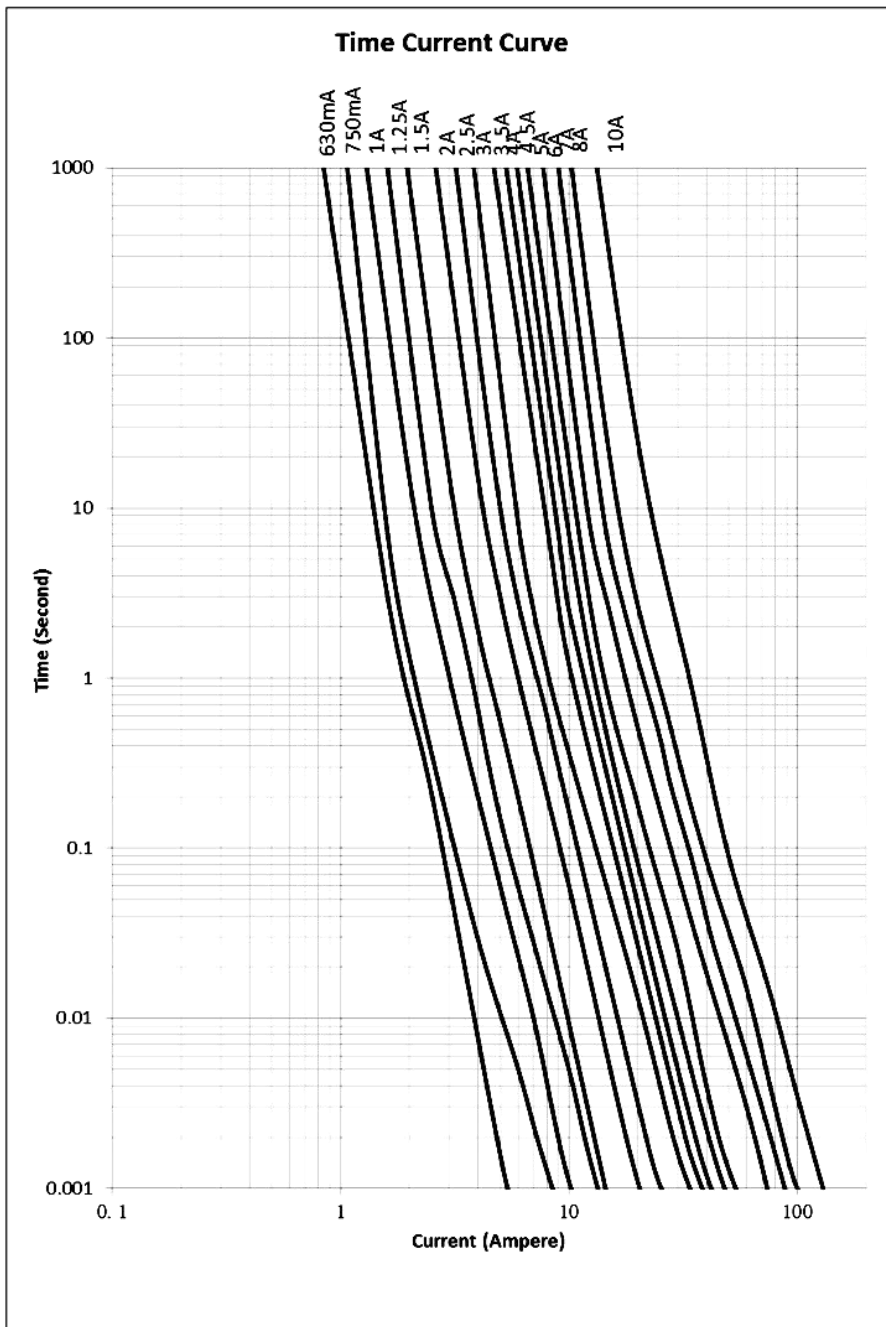

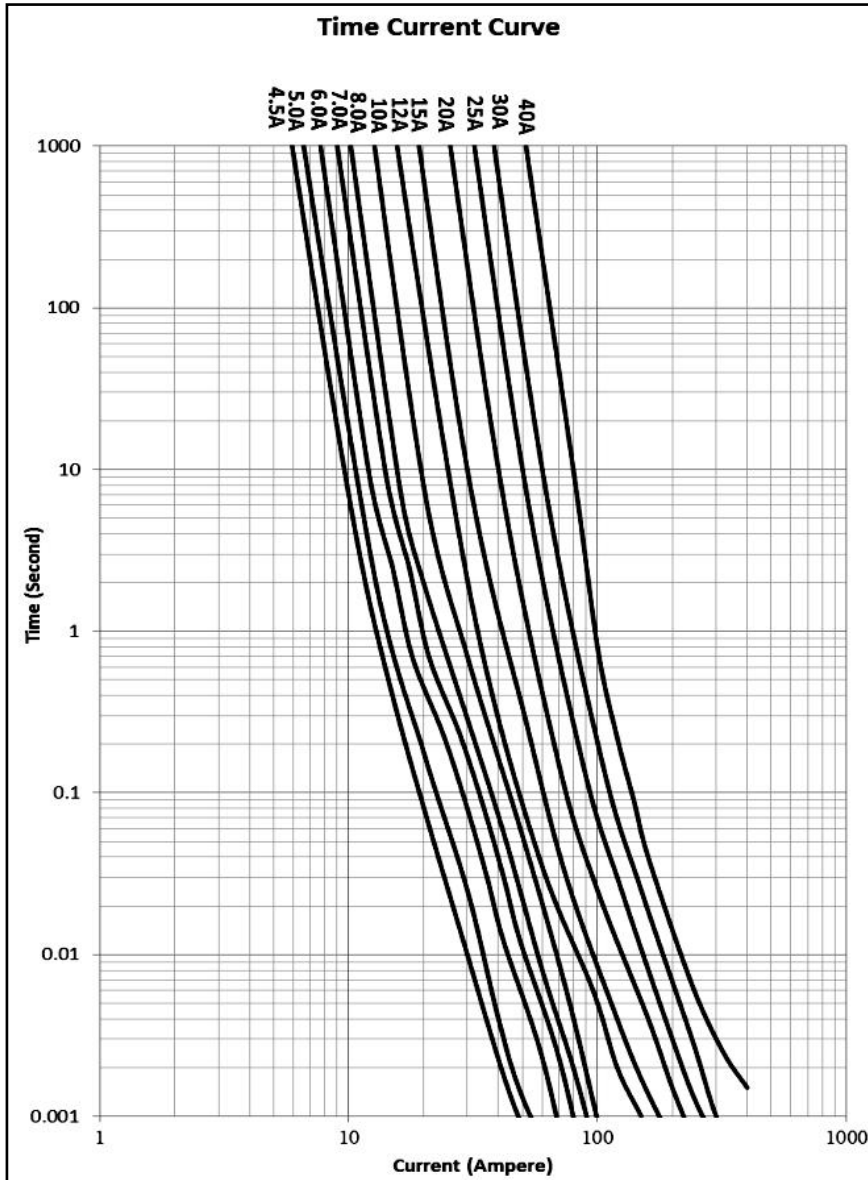

5-3 时间T—I²T特性曲线/Time-I²T Curve:

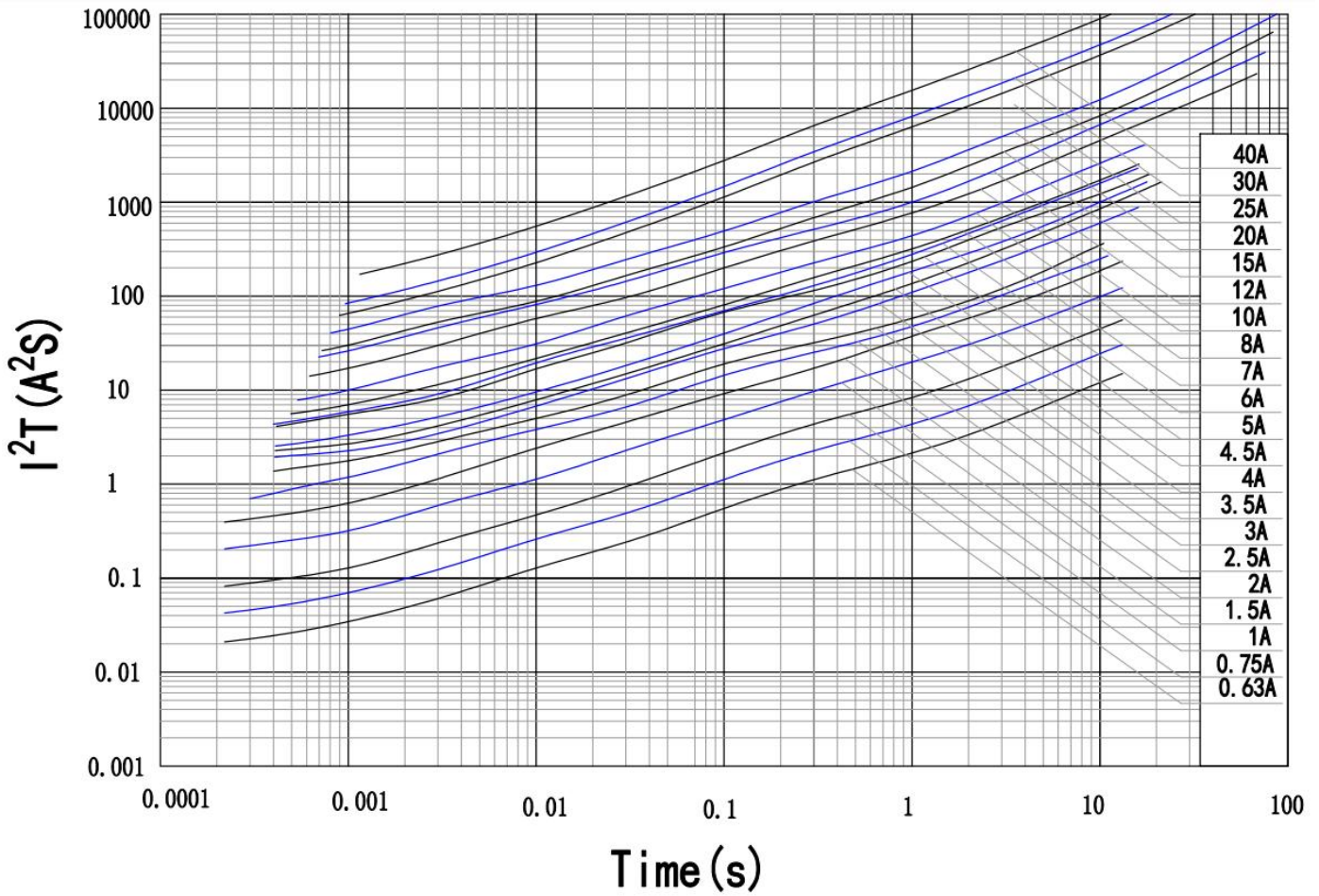

5-4 分断能力 / Breaking Capacity

RATED CURRENT 额定电流	BREAKING APACITY 分断电流
250mA to 10A	48VDC@200A 125VDC@50A 125VAC@50A
12A-30A	48VDC@200A
40A	36VDC@200A

6. 产品特性及信赖性测试规范/PRODUCT CHARACTERISTICS AND RELIABILITY TEST STANDARD

序号 NO	项目 Item	内容 Contain	判断标准 Criteria
1	时间/电流特性 Time/current characteristics	通1.0In、2.0In、3.5In电流，测试熔断时间 I=1.0In、2.0In、3.5In Test time	各电流条件下测试时间符合规定值 Value of time measured in different currents is within spec. UL248-1/-14
2	分断能力测试 Breaking capacity	250mA-10A: 48VDC@200A; 125VDC@50A; 125VAC@50A 12A-30A:48VDC@200A 40A:36VDC@200A	没有持续电弧、燃烧、爆炸现象 No a permanent arcing, ignition, bursting UL248-1/-14
3	可焊性 Solder ability	锡炉温度 245℃±5℃，浸入深度 2.0mm±0.5mm，浸锡时间 5±0.5s，放在20X的放大镜下检查湿润率 T=245℃±5℃，t=5s±0.5s; magnifier : 20X	湿润率盖率≥95% Cover ≥95% MIL-STD-202 Method 208
4	抗焊性测试 Soldering heat resistance	锡炉温度T =250℃±5℃，浸锡时间t =30±5s T=250±5℃，t=30±5s	外观无裂纹/损伤，标识清晰可辨；前后阻值偏差≤15%； No crack and damage, Marking is easily legible △R<15% MIL-STD-202, Method 210F, Condition K
5	冷热冲击 Thermal Shock	-65℃，停留 15min，→25℃，停留 5min→125℃停留15min；循环次数为100次 -65℃ 15min→25℃ 5min→+125℃ 15min； 100 cycles	外观无裂纹/损伤，前后阻值偏差<10% No crack and damage, △R<10% MIL-STD-202, Method 213B
6	机械冲击 Mechanica Shock	峰值100 G,持续时间11ms,波形：半正弦，五次脉冲 a=100G for 11ms, 5pulses	外观无裂纹和损伤，前后阻值偏差<±10%。 No crack and damage, △R<10% MIL-STD-202, Method 213B
7	振动测试 Vibration	承受振幅为0.03英寸(全程最大0.06英寸),频率在大约10Hz到55Hz的范围均匀地变化的简谐运动)	MIL-STD-202, Method 201A
8	高频振动测试 Vibration, High Frequency	20g's峰值，公差值为±10%，振动频率10Hz-2000Hz，总计时间为12h	MIL-STD-202, Method 204D, Condition D
9	盐雾试验 Salt spray test	1.溶液浓度：5±0.1% 2.PH值：6.5~7.2 3.试验箱温度：35±2℃，压力桶温度：47±1℃ 4.连续放置48小时	1.外观正常，无明显变色等变化 2.冷电阻值变化小于±10% 3.测试后从中抽取样品校正额定电流，运行4h不熔断。 GB/T2423.17-2008
10	弯曲试验 Bending test	1.将保险丝焊接在测试板上 2.将试验板放在弯曲夹具上，试验板3.以1mm/s的速度将试验板弯曲1mm，保持时间60s	1.保险丝焊盘无明显的裂缝； 3.试验前后阻值变化≤15% 3.通100%In电流，4H内不熔断 IEC 60127

7. 环境特性 / ENVIRONMENTAL CHARACTERISTIC

7-1 操作温度范围: $-55^{\circ}\text{C} \sim 125^{\circ}\text{C}$ / Operating Temperature: $-55^{\circ}\text{C} \sim 125^{\circ}\text{C}$, 若贵司操作环境温度超出 $23 \pm 3^{\circ}\text{C}$ 范围, 在选用保险丝规格时, 需考虑操作环境温度对保险丝的影响。请参照: 温度-电流曲线图。

When choosing the fuse's specification, if the operating environmental temperature beyond the scope from $20 \sim 26^{\circ}\text{C}$, you should consider the environmental temperature's affection to fuses.

please refer:

Temperature-Current curve:

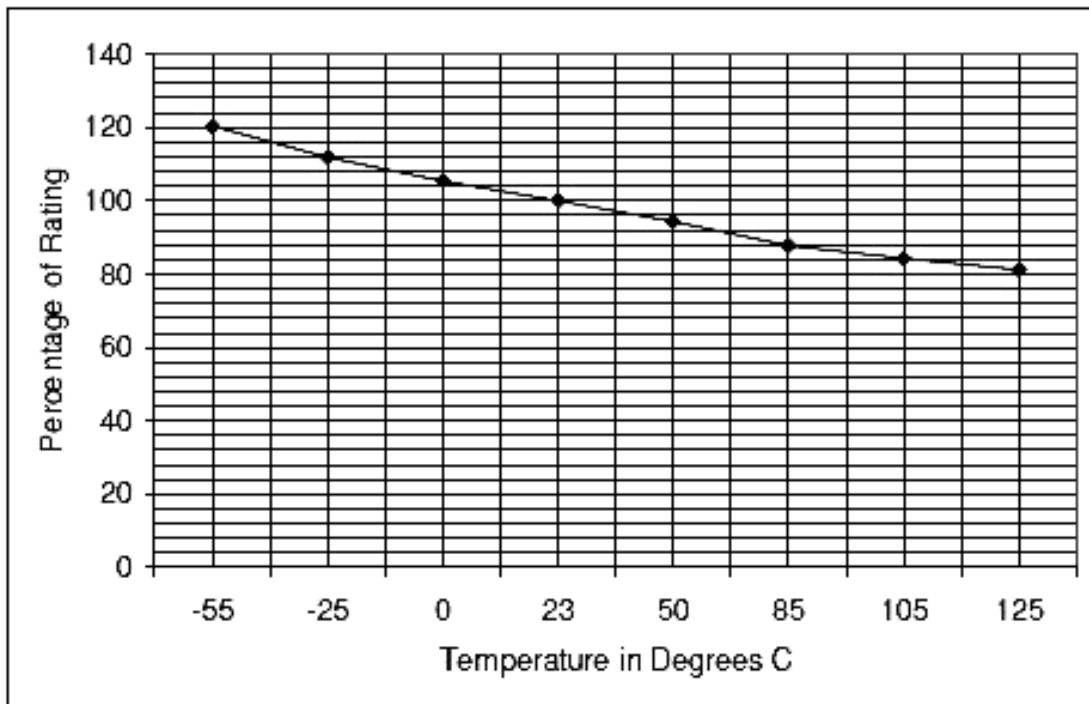

7-2 存储条件 / Storage Conditions

在温度 $10^{\circ}\text{C} \sim 40^{\circ}\text{C}$ 、相对湿度 $\leq 75\%$ 的密闭条件下可存放 2 年。

Under airtight in temperature $10^{\circ}\text{C} \sim 40^{\circ}\text{C}$ 、relative humidity $\leq 75\%$ can store 2 years.

在温度 $10^{\circ}\text{C} \sim 40^{\circ}\text{C}$ 、相对湿度为 95% 的非露天下最多可存放 30 天。

Without dew in temperature $10^{\circ}\text{C} \sim 40^{\circ}\text{C}$ 、relative humidity be 95% maximum value for 30days.

8. 焊垫尺寸及焊接条件 / SOLDER PAD SIZE AND WELDING CONDITIONS

8-1 焊垫尺寸建议 / Recommended Size of the Pad.

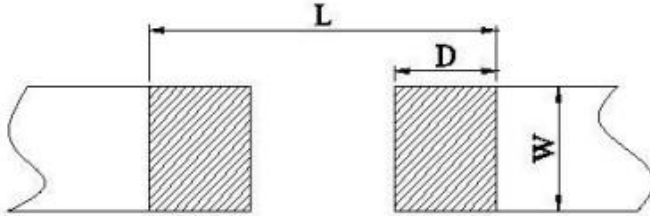

L	W	D	t
4.56mm	2.03mm	1.52mm	≥ 35μm

t : 元件焊垫金属层厚度 (min.) / t : Thickness of pad metal (min.)

8-2 焊接参数建议 / Recommended Customer Soldering Parameters

温度曲线 Temperature Condition

预热段 : 145 ± 15°C, max. 120 sec

Preheating : 145 ± 15°C, max.120 sec.

焊锡段 : min. 220°C, max. 60 sec.

Soldering: min. 220°C, max. 60 sec.

允许最高温度 : 260±5°C, max. 10sec.

Maximum temperature : 260±5°C, max. 10sec.

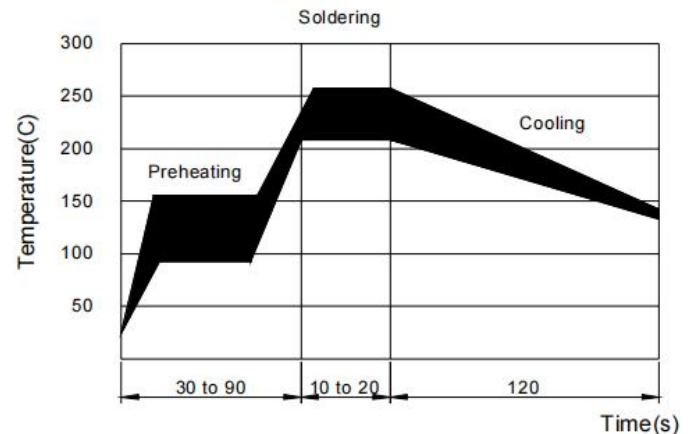

允许烙铁焊接条件(热风设备): 350°C, 3~5seconds

Rework Temperature (hot air equipment) : 350°C, 3~5seconds

8-3 焊接方法建议 / Recommended Reflow Methods

焊接热源方式可用红外线, 热蒸气, 热风

IR, vapor phase oven, hot air oven.

如果焊锡温度超过允许最高温度, 则产品本身会有功能损坏的疑虑

If reflow temperatures exceed the recommended profile, devices may not meet the performance requirements.

9. 批量生产出货测试项目 / LOT ACCEPTANCE TEST REQUIREMENTS

9-1 外观 / Visual

方法：利用放大镜进行检查

Procedure: Visual

标准：不能有脏污、不洁、文印错误、破损等

Acceptance Criteria: No parts are outstandingly stained.

9-2 尺寸 / Dimensions

方法：使用合适且经校正的标尺

Procedure: As appropriate, calipers, micrometers, optical comparator, or approved gages.

标准：尺寸均在标准范围内

Acceptance Criteria: No parts outside specific dimensions.

9-3 时间-电流特性 / Time-Current Characteristics

方法：测试电流 $I=1.0I_n; 2.0I_n; 3.5I_n$ ；量测出个别电流下的对应时间

Procedure : $I=1.0I_n; 2.0I_n; 3.5I_n$; and measure the value of time individually by meter at 25°C

标准：对应时间值均在标准范围内/Acceptance Criteria: All parts must within the specific .

9-4 分断能力 / Breaking Capacity

方法：测试电压\电流为

250mA-10A: 48VDC@200A, 125VDC@50A, 125VAC@50A; 12A-30A:48VDC@200A;
40A:36VDC@200A;

利用此条件冲击元件

Procedure:

250mA-10A: 48VDC@200A, 125VDC@50A, 125VAC@50A; 12A-30A:48VDC@200A;
40A:36VDC@200A;

标准：元件不发生持续电弧燃烧及爆裂

Acceptance Criteria: No permanent arcing, ignition, bursting

10. 安全认证及编号 / STANDARDS AND APPROVALS

UL

E213695

11. 包装讯息 / PACKING INFORMATION

11-1 包装数量、重量 / QUANTITY & WEIGHT

编码 Part Number	数量 (pcs) Quantity(pcs)	重量(g) Weight(g)
1206 TD * A *V	3,000	84±20

11-2 卷轮规格 / Reel & Tape specifications

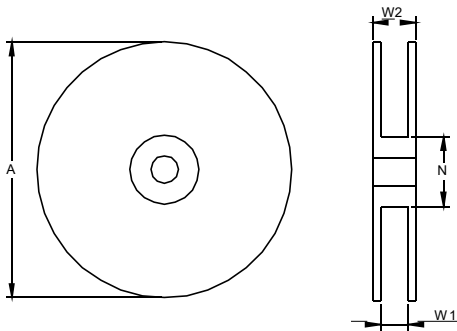

A ± 5	N ± 2	W1 +1/-0	W2 Max.
178	60	8.4	12.4

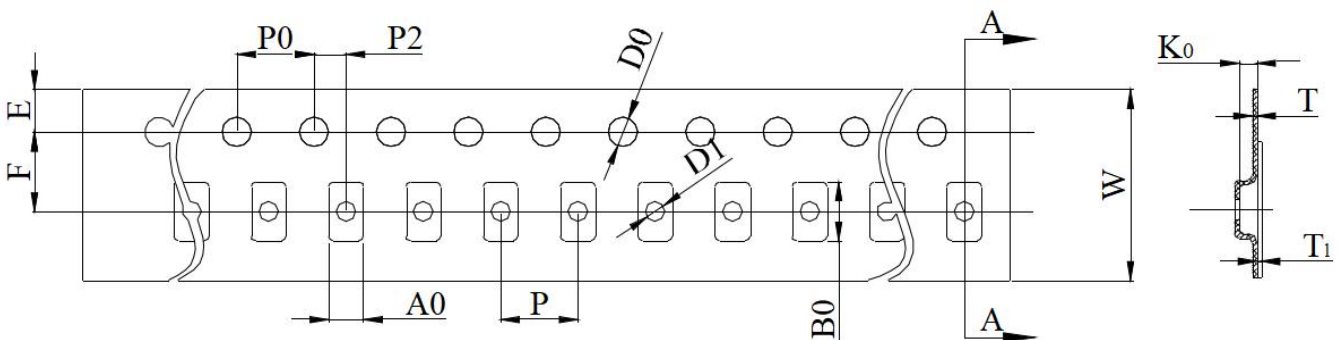

W	8.00 ± 0.30	D0	1.50 ± 0.10
P0	4.00 ± 0.10	F	3.50 ± 0.10
P	4.00 ± 0.10	E	1.75 ± 0.10
P2	2.00 ± 0.10	T	0.20 ± 0.05
A0	1.82 ± 0.15	T1	Max. 0.1
B0	3.53 ± 0.15	K0	0.85 ± 0.15

11-3 密封胶膜剥离强度要求 / Peeling Strength of Seal Tape

F = 剥离强度 : 0.3 – 1.0N (30 - 100gf)

F = Peeling Strength: 0.3 – 1.0N (30 - 100gf)

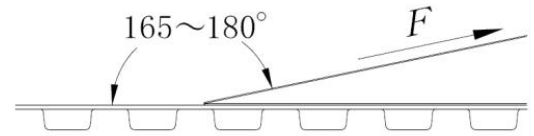

12. 其他 / OTHERS

12-1 如果在使用中有超出本规格书的要求，必须经由双方协商确认.

In the event that an impropriety is found beyond this specification ,it shall be fixed by mutual agreement between the parties.

12-2 如果本规格书有不适当的情况，必须通过双方协商并由本公司修改.

In the event that an impropriety is found in this specification , LANBAO ELECTRICAL APPLIANCES CO. LTD. shall amend it by mutual agreement between the parties.

版次	制作	确认	审核
第二版	赖秋莲 2022/09/18	谢海林 2022/09/18	熊士军 2022/09/18



JDYX2.E213695 - Fuses, Supplemental - Component

Fuses, Supplemental - Component

ZHONG SHAN LANBAO ELECTRICAL APPLIANCES CO LTD

E213695

West Xing Pu Rd

Huang Pu

Zhongshan, Guangdong 528429 China

Cat. No.	Size mm(in)	Amps (A)	Volts (V)	Interrupting Rating (A)
Supplemental fuses				
2C	5 x 20 (0.20 x 0.79)	0.1-2.5	250Vac	100
		5-12.5	250Vac	100
2F	5.2 x 20 (0.20 x 0.79)	2.5-6.3	250Vac	100
		0.1-2	250Vac	35
2T	5.2 x 20 (0.20 x 0.79)	0.1-0.4	250Vac	35
		0.5-1.0	250Vac	35
		1.1-5.0	250Vac	100
		6.0-15	250Vac	100
3F	6.3 x 32 (0.25 x 1.26)	0.1-10	250Vac	100
		12-15	250Vac	100
3T	6.3 x 32 (0.25 x 1.26)	0.1-10	350Vac	100
		10.1-20	350Vac	100
RFI-20	5.2 x 20 (0.20 x 0.79)	0.1-2.0	250Vac	35
		2.5-6.3	250Vac	100
RFI-30	6.3 x 32 (0.25 x 1.26)	0.1-10	250Vac	100
		12-15	250Vac	100
RTC-20	5 x 20 (0.20 x 0.79)	0.1-2.5	250Vac	100
		5-12.5	250Vac	100

RTI-20	5.2 x 20 (0.20 x 0.79)	0.1-0.4	250Vac	35
		0.5-1.0	250Vac	35
		1.1-5.0	250Vac	100
		6.0-15	250Vac	100
RTI-30	6.3 x 32 (0.25 x 1.26)	0.1-10	250Vac	100
		10.1-20	250Vac	100
Supplemental fuses: pigtail leads				
2P	5.2 x 20 (0.20 x 0.79)	2.5-6.3	250Vac	100
		0.1-2	250Vac	35
RFP-20	5.2 x 20 (0.20 x 0.79)	0.1-2.0	250Vac	35
		2.5-6.3	250Vac	100
Supplemental fuses: filled-tube, cartridge enclosed				
LB630	6.4 x 31.8 (0.25 x 1.25)	0.1-30	750Vac	500
		0.1-30	750Vdc	500
		0.1-30	500Vac	500
		0.1-30	500Vdc	500
		0.1-30	250Vac	500
		0.1-30	250Vdc	500
Supplemental fuses: pigtail leads, filled-tube, cartridge enclosed				
LB630(P)	6.8 x 32.5 (0.27 x 1.28)	0.1-30	750Vac	500
		0.1-30	750Vdc	500
		0.1-30	500Vac	500
		0.1-30	500Vdc	500
		0.1-30	250Vac	500
		0.1-30	250Vdc	500
Supplemental micro fuses: pigtail leads, surface mount				
TB, TR	8.5 x 4 x 5 (0.33 x 0.16 x 0.20)	0.05-10	400Vac	100
		0.05-10	300Vac	100
		0.05-10	250Vac	100

		0.05-10	125Vac	100
		0.05-10	125Vdc	100
Supplemental micro fuses: surface mount				
0603FF, 0603HI or 0603TD	1.6 x 0.8 x 0.5 (0.06 x 0.03 x 0.02)	0.25-8	24Vdc	50
		0.25-8	32Vdc	50
		0.25-8	48Vdc	50
		0.25-8	63Vdc	50
1206FF, 1206HI, 1206HV or 1206TD	3.2 x 1.6 x 0.5 (0.13 x 0.06 x 0.02)	0.25-10	125Vac	50
		0.25-10	63Vdc	50
		0.25-10	72Vdc	50
		0.25-10	125Vdc	50
		0.25-30	48Vdc	200
		0.25-50	24Vdc	200
		0.25-50	32Vdc	200
		0.25-50	36Vdc	200

Marking: Company name or trademark  and model designation.

Last Updated on 2022-01-07

并不是所有出现在本数据库中的公司名称和产品都满足了UL跟踪检验服务的要求。只有带有UL标志的产品，才应该被视为经过UL认证，并满足UL跟踪检验服务的要求。注意查看产品上的标志。

UL允许在线认证目录中所含材料的复制遵循以下条件：1.指南信息、装配、构造、设计、系统和/或认证（文件）必须在不篡改任何数据（或图纸）的情况下完整且无误导性地呈现。2.经UL允许从在线认证目录转载“声明必须出现在所摘取材料的邻近位置。此外，转载材料必须包含以下格式的版权声明：“© 2022 UL LLC”