

*Operational Amplifier, Rail-to-Rail, Low Voltage,
Single and Dual(compatible to LMV93X)*

The HT8931 Single and HT8932 Dual are CMOS low-voltage operational amplifiers which can operate on single-sided power supplies (1.8 V to 5.0 V) with rail-to-rail input and output swing. Both devices come in small state-of-the-art packages and require very low quiescent current making them ideal for battery-operated, portable applications such as notebook computers and hand-held instruments. Rail-to-Rail operation provides improved signal-to-noise performance plus the small packages allow for closer placement to signal sources thereby reducing noise pickup.

The single HT8931 is offered in space saving SC70-5 package. The dual HT8932 is in either a Micro8 or SOIC package. These small packages are very beneficial for crowded PCB's.

Features

- Performance Specified on Single-Sided Power Supply: 1.8 V, 2.7 V, and 5 V
- Small Packages:
 - HT8931 in a SC-70
 - HT8932 in a Micro8 or SOIC-8
- No Output Crossover Distortion
- Extended Industrial Temperature Range: -40°C to +125°C
- Low Quiescent Current 210 μ A, Max Per Channel
- No Output Phase-Reversal from Overdriven Input
- These are Pb-Free Devices

Typical Applications

- Notebook Computers, Portable Battery-Operated Instruments, PDA's
- Active Filters, Low-Side Current Monitoring

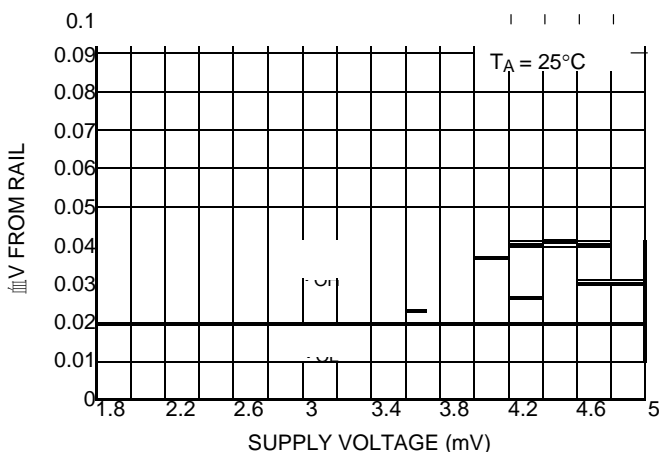
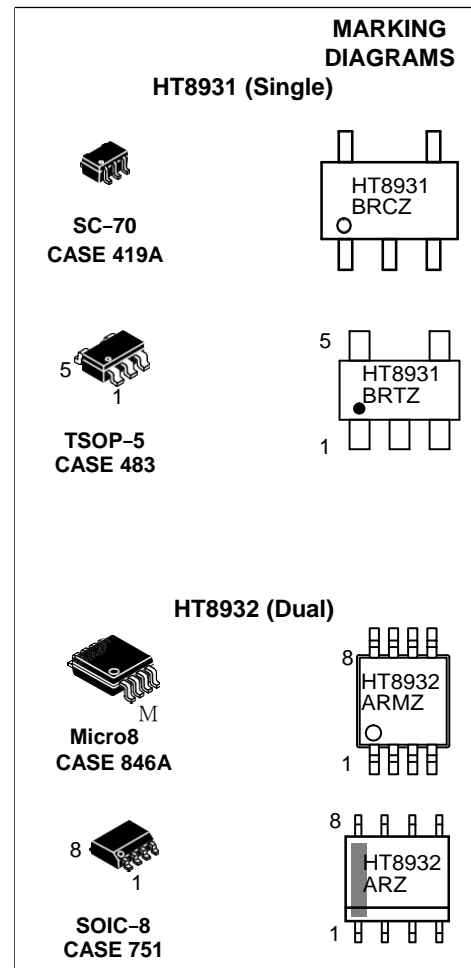
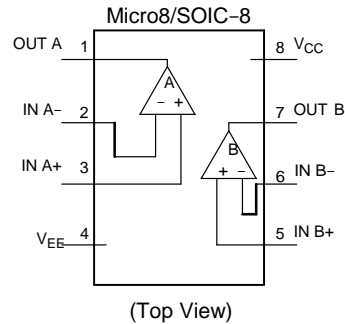
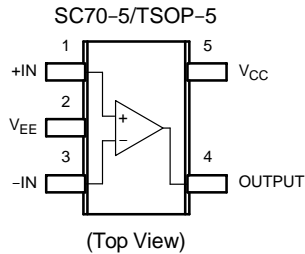

Figure 1. Output Voltage Swing vs. Supply Voltage



PIN CONNECTIONS

MAXIMUM RATINGS

Symbol	Rating	Value	Unit
V_S	Supply Voltage (Operating Range $V_S = 1.8\text{ V to }5.5\text{ V}$)	5.5	V
V_{IDR}	Input Differential Voltage	\pm Supply Voltage	V
V_{ICR}	Input Common Mode Voltage Range	$-0.5\text{ to }(V_{CC}) + 0.5$	V
	Maximum Input Current	10	mA
t_{SO}	Output Short Circuit (Note 1)	Continuous	
T_J	Maximum Junction Temperature (Operating Range $-40^\circ\text{C to }85^\circ\text{C}$)	150	$^\circ\text{C}$
θ_{JA}	Thermal Resistance:	SC-70 TSOP-5 Micro8	$^\circ\text{C/W}$
T_{stg}	Storage Temperature	$-65\text{ to }150$	$^\circ\text{C}$
	Mounting Temperature (Infrared or Convection $\therefore 30\text{ sec}$)	260	$^\circ\text{C}$

Stresses exceeding Maximum Ratings may damage the device. Maximum Ratings are stress ratings only. Functional operation above the Recommended Operating Conditions is not implied. Extended exposure to stresses above the Recommended Operating Conditions may affect device reliability.

ESD data available upon request.

1. Continuous short-circuit operation to ground at elevated ambient temperature can result in exceeding the maximum allowed junction temperature of 150°C . Output currents in excess of 45 mA over long term may adversely affect reliability. Shorting output to either V_{CC} or V_{EE} will adversely affect reliability.

1.8 V DC ELECTRICAL CHARACTERISTICS (Note 2) Unless otherwise noted, all min/max limits are guaranteed for $T_A = 25^\circ\text{C}$, $V_S = 1.8\text{ V}$, $V_{CM} = V_S/2$, $V_O = V_S/2$ and $R_L > 1\text{ M}\Omega$. Typical specifications represent the most likely parametric norm.

Parameter	Symbol	Condition	Min	Typ	Max	Unit
Input Offset Voltage	V_{IO}	HT8931 (Single) (-40°C to $+125^\circ\text{C}$)		1	6	mV
		HT8932 (Dual) (-40°C to $+125^\circ\text{C}$)		1	7.5	
Input Offset Voltage Average Drift	TCV_{IO}			5.5		$\mu\text{V}/^\circ\text{C}$
Input Bias Current	I_B	-40°C to $+125^\circ\text{C}$		< 1		nA
Input Offset Current	I_{IO}	-40°C to $+125^\circ\text{C}$		< 1		nA
Supply Current (per Channel)	I_{CC}	In Active Mode		75	185	μA
		-40°C to $+125^\circ\text{C}$			205	
Common Mode Rejection Ratio	CMRR	$0\text{ V} :: V_{CM} :: 0.6\text{ V}, 1.4\text{ V} :: V_{CM} :: 1.8\text{ V}$	50	70		dB
		-40°C to $+125^\circ\text{C}$	50			
		$-0.2\text{ V} :: V_{CM} :: 0\text{ V}, 1.8\text{ V} :: V_{CM} :: 2\text{ V}$	50	70		
Power Supply Rejection Ratio	PSRR	$1.8\text{ V} :: V^+ :: 5\text{ V}, V_{CM} = 0.5\text{ V}$	50	70		dB
		-40°C to $+125^\circ\text{C}$	50			
Input Common-Mode Voltage Range	V_{CM}	For CMRR $\geq 50\text{ dB}$ and $T_A = 25^\circ\text{C}$	V_{EE} -0.2	-0.2 to 2.1	V_{CC} $+0.2$	V
		For CMRR $\geq 50\text{ dB}$ and $T_A = -40^\circ\text{C}$ to $+85^\circ\text{C}$	V_{EE}		V_{CC}	
		For CMRR $\geq 50\text{ dB}$ and $T_A = -40^\circ\text{C}$ to $+125^\circ\text{C}$	V_{EE} $+0.2$		V_{CC} -0.2	
Large Signal Voltage Gain HT8931 (Single)	A_V	$R_L = 600\ \Omega$ to 0.9 V , $V_O = 0.2\text{ V}$ to 1.6 V , $V_{CM} = 0.5\text{ V}$	77	101		dB
		-40°C to $+125^\circ\text{C}$	73			
		$R_L = 2\text{ k}\Omega$ to 0.9 V , $V_O = 0.2\text{ V}$ to 1.6 V , $V_{CM} = 0.5\text{ V}$	80	105		
		-40°C to $+125^\circ\text{C}$	75			
Large Signal Voltage Gain HT8932 (Dual)	A_V	$R_L = 600\ \Omega$ to 0.9 V , $V_O = 0.2\text{ V}$ to 1.6 V , $V_{CM} = 0.5\text{ V}$	75	90		dB
		-40°C to $+125^\circ\text{C}$	72			
		$R_L = 2\text{ k}\Omega$ to 0.9 V , $V_O = 0.2\text{ V}$ to 1.6 V , $V_{CM} = 0.5\text{ V}$	78	100		
		-40°C to $+125^\circ\text{C}$	75			
Output Swing	V_{OH}	$R_L = 600\ \Omega$ to 0.9 V , $V_{IN} = \pm 100\text{ mV}$	1.65	1.72		V
		-40°C to $+125^\circ\text{C}$	1.63			
	V_{OL}	$R_L = 600\ \Omega$ to 0.9 V , $V_{IN} = \pm 100\text{ mV}$		0.077	0.105	
		-40°C to $+125^\circ\text{C}$			0.12	
	V_{OH}	$R_L = 2\text{ k}\Omega$ to 0.9 V , $V_{IN} = \pm 100\text{ mV}$	1.75	1.77		
		-40°C to $+125^\circ\text{C}$	1.74			
	V_{OL}	$R_L = 2\text{ k}\Omega$ to 0.9 V , $V_{IN} = \pm 100\text{ mV}$		0.24	0.035	
		-40°C to $+125^\circ\text{C}$			0.04	
Output Short Circuit Current	I_O	Sourcing, $V_O = 0\text{ V}$, $V_{IN} = +100\text{ mV}$	4.0	30		mA
		-40°C to $+125^\circ\text{C}$	3.3			
		Sinking, $V_O = 1.8\text{ V}$, $V_{IN} = -100\text{ mV}$	7.0	60		
		-40°C to $+125^\circ\text{C}$	5.0			

2. Guaranteed by design and/or characterization.

1.8 V AC ELECTRICAL CHARACTERISTICS Unless otherwise specified, all limits are guaranteed for $T_A = 25^\circ\text{C}$, $V_S = 1.8\text{ V}$, $V_{CM} = V_S/2$, $V_O = V_S/2$ and $R_L > 1\text{ M}\Omega$. Typical specifications represent the most likely parametric norm. Min/Max specifications are guaranteed by testing, characterization, or statistical analysis.

Parameter	Symbol	Condition	Min	Typ	Max	Unit
Slew Rate	SR	(Note 3)		0.35		V/ μS
Gain Bandwidth Product	GBWP			1.4		MHz
Phase Margin	ϕ_m			67		$^\circ$
Gain Margin	Gm			7		dB
Input-Referred Voltage Noise	e_n	$f = 50\text{ kHz}$, $V_{CM} = 0.5\text{ V}$		60		nV/ $\sqrt{\text{Hz}}$
Total Harmonic Distortion	THD	$f = 1\text{ kHz}$, $A_V = +1$, $R_L = 600\ \Omega$, $V_O = 1\text{ V}_{PP}$		0.023		%
Amplifier-to-Amplifier Isolation		(Note 4)		123		dB

3. Connected as voltage follower with input step from V_{EE} to V_{CC} . Number specified is the slower of the positive and negative slew rates.
4. Input referred, $R_L = 100\text{ k}\Omega$ connected to $V_S/2$. Each amp excited in turn with 1 kHz to produce $V_O = 3\text{ V}_{PP}$. (For Supply Voltages $< 3\text{ V}$, $V_O = V_{CC}$).

2.7 V DC ELECTRICAL CHARACTERISTICS (Note 5) Unless otherwise noted, all min/max limits are guaranteed for $T_A = 25^\circ\text{C}$, $V_S = 2.7\text{ V}$, $V_{CM} = V_S/2$, $V_O = V_S/2$ and $R_L > 1\text{ M}\Omega$. Typical specifications represent the most likely parametric norm.

Parameter	Symbol	Condition	Min	Typ	Max	Unit
Input Offset Voltage	V_{IO}	HT8931 (Single) (-40°C to $+125^\circ\text{C}$)		1	6	mV
		HT8932 (Dual) (-40°C to $+125^\circ\text{C}$)		1	7.5	
Input Offset Voltage Average Drift	TCV_{IO}			5.5		$\mu\text{V}/^\circ\text{C}$
Input Bias Current	I_B	-40°C to $+125^\circ\text{C}$		< 1		nA
Input Offset Current	I_{IO}	-40°C to $+125^\circ\text{C}$		< 1		nA
Supply Current (per Channel)	I_{CC}	In Active Mode		80	190	μA
		-40°C to $+125^\circ\text{C}$			210	
Common Mode Rejection Ratio	CMRR	$0\text{ V} \therefore V_{CM} \therefore 1.5\text{ V}, 2.3\text{ V} \therefore V_{CM} \therefore 2.7\text{ V}$	50	70		dB
		-40°C to $+125^\circ\text{C}$	50			
		$-0.2\text{ V} \therefore V_{CM} \therefore 0\text{ V}, 2.7\text{ V} \therefore V_{CM} \therefore 2.9\text{ V}$	50	70		
Power Supply Rejection Ratio	PSRR	$1.8\text{ V} \therefore V^+ \therefore 5\text{ V}, V_{CM} = 0.5\text{ V}$	50	70		dB
		-40°C to $+125^\circ\text{C}$	50			
Input Common-Mode Voltage Range	V_{CM}	For CMRR $\geq 50\text{ dB}$ and $T_A = 25^\circ\text{C}$	V_{EE} -0.2	-0.2 to 3.0	V_{CC} $+0.2$	V
		For CMRR $\geq 50\text{ dB}$ and $T_A = -40^\circ\text{C}$ to $+85^\circ\text{C}$	V_{EE}		V_{CC}	
		For CMRR $\geq 50\text{ dB}$ and $T_A = -40^\circ\text{C}$ to $+125^\circ\text{C}$	V_{EE} $+0.2$		V_{CC} -0.2	
Large Signal Voltage Gain HT8931 (Single)	A_V	$R_L = 600\ \Omega$ to 1.35 V , $V_O = 0.2\text{ V}$ to 2.5 V	87	104		dB
		-40°C to $+125^\circ\text{C}$	86			
		$R_L = 2\text{ k}\Omega$ to 1.35 V , $V_O = 0.2\text{ V}$ to 2.5 V	92	110		
		-40°C to $+125^\circ\text{C}$	91			
Large Signal Voltage Gain HT8932 (Dual)	A_V	$R_L = 600\ \Omega$ to 1.35 V , $V_O = 0.2\text{ V}$ to 2.5 V	78	90		
		-40°C to $+125^\circ\text{C}$	75			
		$R_L = 2\text{ k}\Omega$ to 1.35 V , $V_O = 0.2\text{ V}$ to 2.5 V	81	100		
		-40°C to $+125^\circ\text{C}$	78			
Output Swing	V_{OH}	$R_L = 600\ \Omega$ to 1.35 V , $V_{IN} = \pm 100\text{ mV}$	2.55	2.62		V
		-40°C to $+125^\circ\text{C}$	2.53			
	V_{OL}	$R_L = 600\ \Omega$ to 1.35 V , $V_{IN} = \pm 100\text{ mV}$		0.083	0.11	
		-40°C to $+125^\circ\text{C}$			0.13	
	V_{OH}	$R_L = 2\text{ k}\Omega$ to 1.35 V , $V_{IN} = \pm 100\text{ mV}$	2.65	2.675		
		-40°C to $+125^\circ\text{C}$	2.64			
	V_{OL}	$R_L = 2\text{ k}\Omega$ to 1.35 V , $V_{IN} = \pm 100\text{ mV}$		0.025	0.04	
		-40°C to $+125^\circ\text{C}$			0.045	
Output Short Circuit Current	I_O	Sourcing, $V_O = 0\text{ V}$, $V_{IN} = \pm 100\text{ mV}$	20	65		mA
		-40°C to $+125^\circ\text{C}$	15			
		Sinking, $V_O = 0\text{ V}$, $V_{IN} = -100\text{ mV}$	18	75		
		-40°C to $+125^\circ\text{C}$	12			

5. Guaranteed by design and/or characterization.

2.7 V AC ELECTRICAL CHARACTERISTICS Unless otherwise specified, all limits are guaranteed for $T_A = 25^\circ\text{C}$, $V_S = 2.7\text{ V}$, $V_{CM} = V_S/2$, $V_O = V_S/2$ and $R_L > 1\text{ M}\Omega$. Typical specifications represent the most likely parametric norm. Min/Max specifications are guaranteed by testing, characterization, or statistical analysis.

Parameter	Symbol	Condition	Min	Typ	Max	Unit
Slew Rate	SR	(Note 6)		0.4		V/ μS
Gain Bandwidth Product	GBWP			1.4		MHz
Phase Margin	ϕ_m			70		$^\circ$
Gain Margin	Gm			7.5		dB
Input-Referred Voltage Noise	e_n	$f = 50\text{ kHz}$, $V_{CM} = 1.0\text{ V}$		57		$\text{nV}/\sqrt{\text{Hz}}$
Total Harmonic Distortion	THD	$f = 1\text{ kHz}$, $A_V = +1$, $R_L = 600\ \Omega$, $V_O = 1\text{ V}_{PP}$		0.022		%
Amplifier-to-Amplifier Isolation		(Note 7)		123		dB

6. Connected as voltage follower with input step from V_{EE} to V_{CC} . Number specified is the slower of the positive and negative slew rates.
 7. Input referred, $R_L = 100\text{ k}\Omega$ connected to $V_S/2$. Each amp excited in turn with 1 kHz to produce $V_O = 3\text{ V}_{PP}$. (For Supply Voltages $< 3\text{ V}$, $V_O = V_{CC}$).

5 V DC ELECTRICAL CHARACTERISTICS (Note 8) Unless otherwise noted, all min/max limits are guaranteed for $T_A = 25^\circ\text{C}$, $V_S = 5\text{ V}$, $V_{CM} = V_S/2$, $V_O = V_S/2$ and $R_L > 1\text{ M}\Omega$. Typical specifications represent the most likely parametric norm.

Parameter	Symbol	Condition	Min	Typ	Max	Unit
Input Offset Voltage	V_{IO}	HT8931 (Single) (-40°C to $+125^\circ\text{C}$)		1	6	mV
		HT8932 (Dual) (-40°C to $+125^\circ\text{C}$)		1	7.5	
Input Offset Voltage Average Drift	TCV_{IO}			5.5		$\mu\text{V}/^\circ\text{C}$
Input Bias Current	I_B	-40°C to $+125^\circ\text{C}$		< 1		nA
Input Offset Current	I_{IO}	-40°C to $+125^\circ\text{C}$		< 1		nA
Supply Current (per Channel)	I_{CC}	In Active Mode		95	210	μA
		-40°C to $+125^\circ\text{C}$			230	
Common-Mode Rejection Ratio	CMRR	0 V :: V_{CM} :: 3.8 V, 4.6 V :: V_{CM} :: 5.0 V	50	70		dB
		-40°C to $+125^\circ\text{C}$	50			
		-0.2 V :: V_{CM} :: 0 V, 5.0 V :: V_{CM} :: 5.2 V	50	70		
Power Supply Rejection Ratio	PSRR	1.8 V :: V^+ :: 5 V, $V_{CM} = 0.5\text{ V}$	50	70		dB
		-40°C to $+125^\circ\text{C}$	50			
Input Common-Mode Voltage Range	V_{CM}	For CMRR $\geq 50\text{ dB}$ and $T_A = 25^\circ\text{C}$	V_{EE} -0.2	-0.2 to 5.3	V_{CC} +0.2	V
		For CMRR $\geq 50\text{ dB}$ and $T_A = -40^\circ\text{C}$ to $+85^\circ\text{C}$	V_{EE}		V_{CC}	
		For CMRR $\geq 50\text{ dB}$ and $T_A = -40^\circ\text{C}$ to $+125^\circ\text{C}$	V_{EE} +0.3		V_{CC} -0.3	
Large Signal Voltage Gain HT8931 (Single)	A_V	$R_L = 600\ \Omega$ to 2.5 V, $V_O = 0.2\text{ V}$ to 4.8 V	88	102		dB
		-40°C to $+125^\circ\text{C}$	87			
		$R_L = 2\text{ k}\Omega$ to 2.5 V, $V_O = 0.2\text{ V}$ to 4.8 V	94	113		
		-40°C to $+125^\circ\text{C}$	93			
Large Signal Voltage Gain HT8932 (Dual)	A_V	$R_L = 600\ \Omega$ to 2.5 V, $V_O = 0.2\text{ V}$ to 4.8 V	81	90		dB
		-40°C to $+125^\circ\text{C}$	78			
		$R_L = 2\text{ k}\Omega$ to 2.5 V, $V_O = 0.2\text{ V}$ to 4.8 V	85	100		
		-40°C to $+125^\circ\text{C}$	82			
Output Swing	V_{OH}	$R_L = 600\ \Omega$ to 2.5 V, $V_{IN} = \pm 100\text{ mV}$	4.855	4.89		V
		-40°C to $+125^\circ\text{C}$	4.835			
	V_{OL}	$R_L = 600\ \Omega$ to 2.5 V, $V_{IN} = \pm 100\text{ mV}$		0.12	0.16	
		-40°C to $+125^\circ\text{C}$			0.18	
	V_{OH}	$R_L = 2\text{ k}\Omega$ to 2.5 V, $V_{IN} = \pm 100\text{ mV}$	4.945	4.967		
		-40°C to $+125^\circ\text{C}$	4.935			
	V_{OL}	$R_L = 2\text{ k}\Omega$ to 2.5 V, $V_{IN} = \pm 100\text{ mV}$		0.037	0.065	
		-40°C to $+125^\circ\text{C}$			0.075	
Output Short-Circuit Current	I_O	Sourcing, $V_O = 0\text{ V}$, $V_{IN} = +100\text{ mV}$	55	65		mA
		-40°C to $+125^\circ\text{C}$	45			
		Sinking, $V_O = 5\text{ V}$, $V_{IN} = -100\text{ mV}$	58	80		
		-40°C to $+125^\circ\text{C}$	45			

8. Guaranteed by design and/or characterization.

5 V AC ELECTRICAL CHARACTERISTICS Unless otherwise specified, all limits are guaranteed for $T_A = 25^\circ\text{C}$, $V_S = 5\text{ V}$, $V_{CM} = V_S/2$, $V_O = V_S/2$ and $R_L > 1\text{ M}\Omega$. Typical specifications represent the most likely parametric norm.

Parameter	Symbol	Condition	Min	Typ	Max	Unit
Slew Rate	SR	(Note 9)		0.48		V/ μS
Gain Bandwidth Product	GBWP			1.5		MHz
Phase Margin	ϕ_m			65		$^\circ$
Gain Margin	Gm			8		dB
Input-Referred Voltage Noise	e_n	$f = 50\text{ kHz}$, $V_{CM} = 2\text{ V}$		50		$\text{nV}/\sqrt{\text{Hz}}$
Total Harmonic Distortion	THD	$f = 1\text{ kHz}$, $A_V = +1$, $R_L = 600\ \Omega$, $V_O = 1\text{ V}_{PP}$		0.022		%
Amplifier-to-Amplifier Isolation		(Note 10)		123		dB

9. Connected as voltage follower with input step from V_{EE} to V_{CC} . Number specified is the slower of the positive and negative slew rates.

10. Input referred, $R_L = 100\text{ k}\Omega$ connected to $V_S/2$. Each amp excited in turn with 1 kHz to produce $V_O = 3\text{ V}_{PP}$. (For Supply Voltages $< 3\text{ V}$, $V_O = V_{CC}$).

TYPICAL CHARACTERISTICS

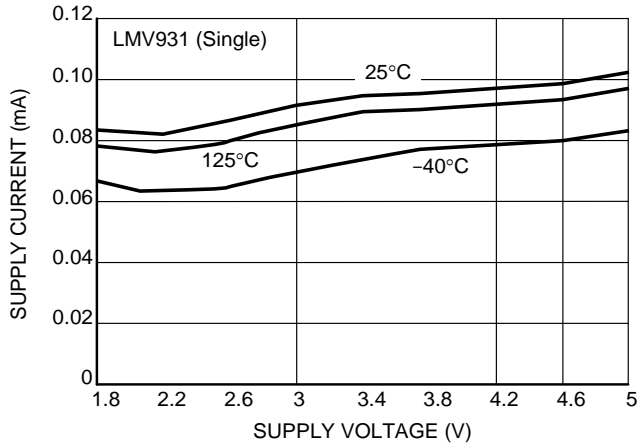
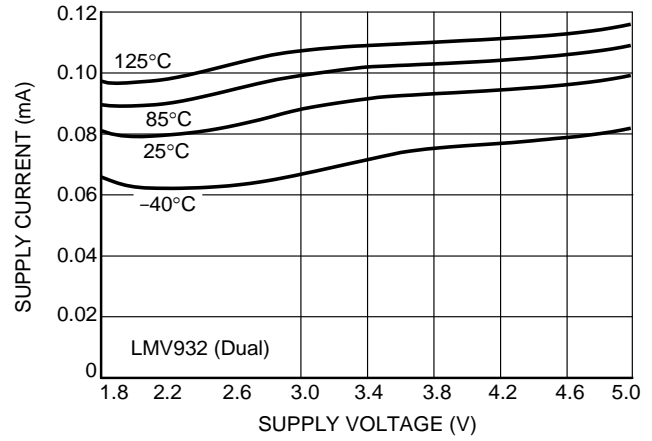
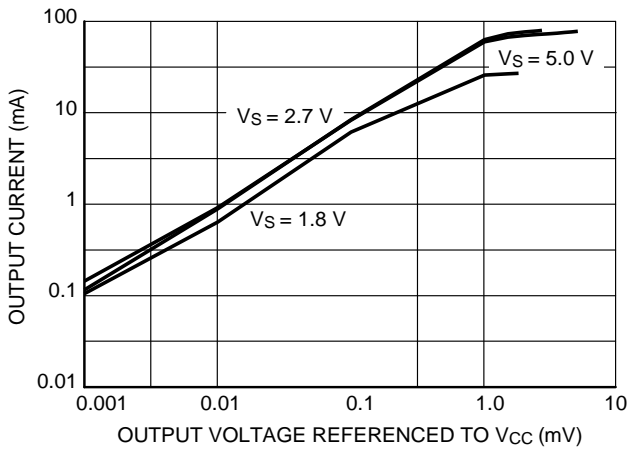
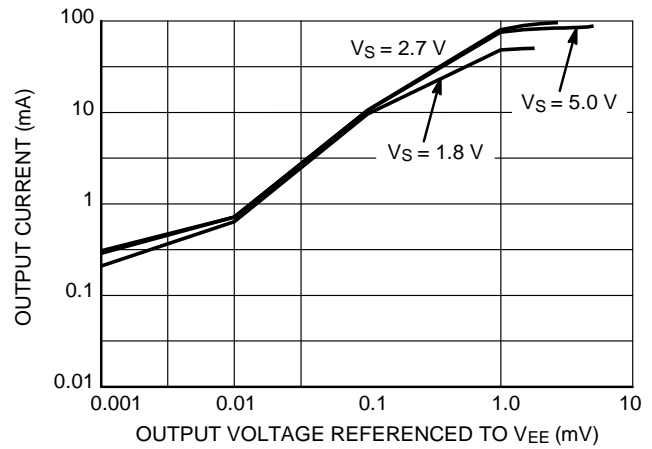
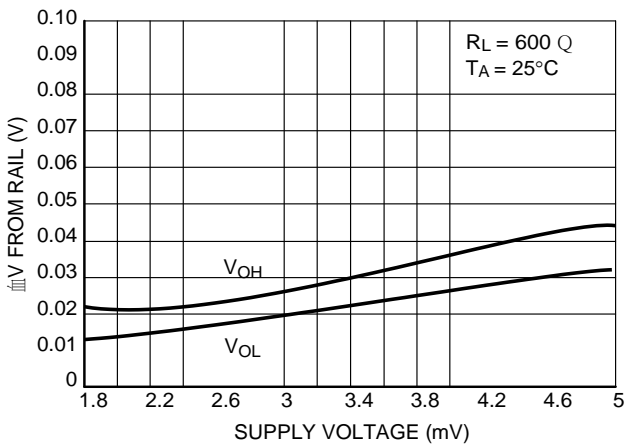
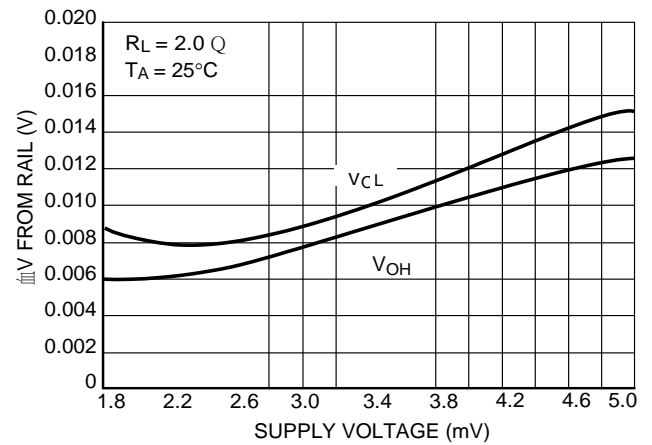
 ($T_A = 25^\circ\text{C}$ and $V_S = 5\text{ V}$ unless otherwise specified)

Figure 2. Supply Current vs. Supply Voltage

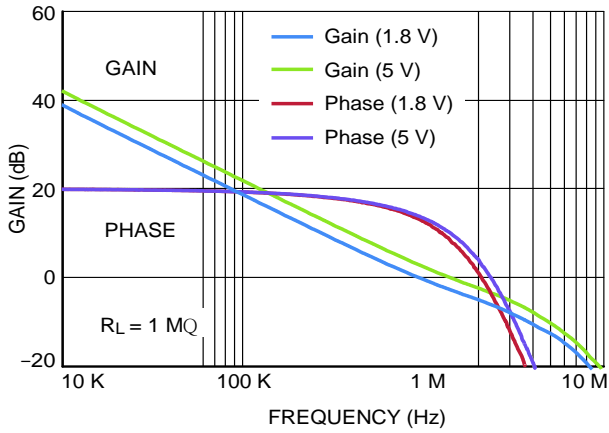
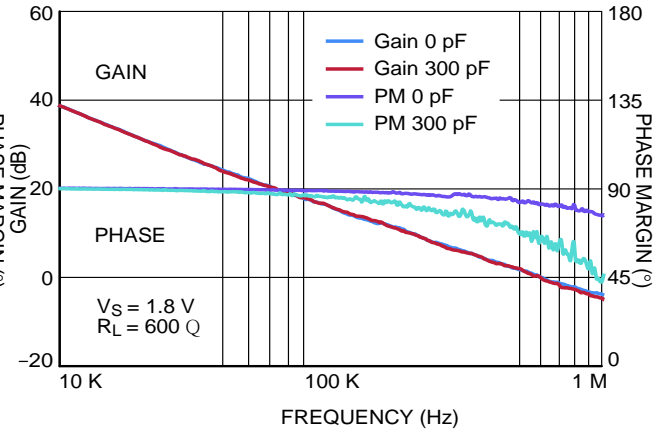
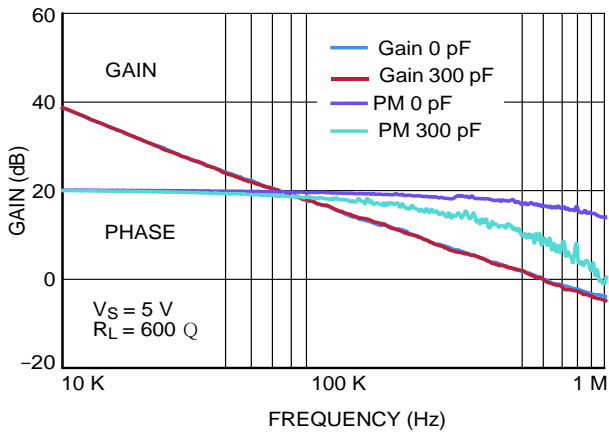
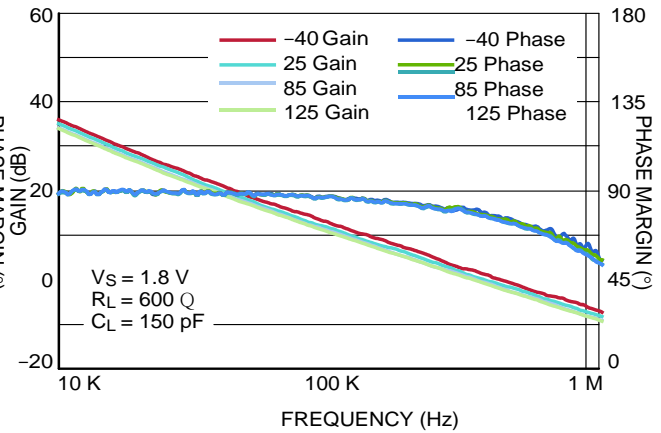
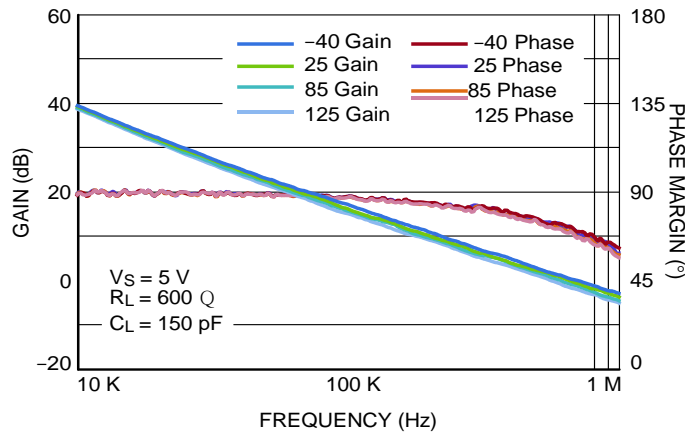
Figure 3. Supply Current vs. Supply Voltage

Figure 4. Sourcing Current vs. Output Voltage
 ($T_A = 25^\circ\text{C}$)

Figure 5. Sinking Current vs. Output Voltage
 ($T_A = 25^\circ\text{C}$)

Figure 6. Output Voltage Swing vs. Supply Voltage

Figure 7. Output Voltage vs. Supply Voltage

TYPICAL CHARACTERISTICS

 ($T_A = 25^\circ\text{C}$ and $V_S = 5\text{ V}$ unless otherwise specified)

Figure 8. Open Loop Gain and Phase

Figure 9. Frequency Response vs. CL

Figure 10. Frequency Response vs. CL

Figure 11. Gain and Phase vs. Temp

Figure 12. Gain and Phase vs. Temp

TYPICAL CHARACTERISTICS

($T_A = 25^\circ\text{C}$ and $V_S = 5\text{ V}$ unless otherwise specified)

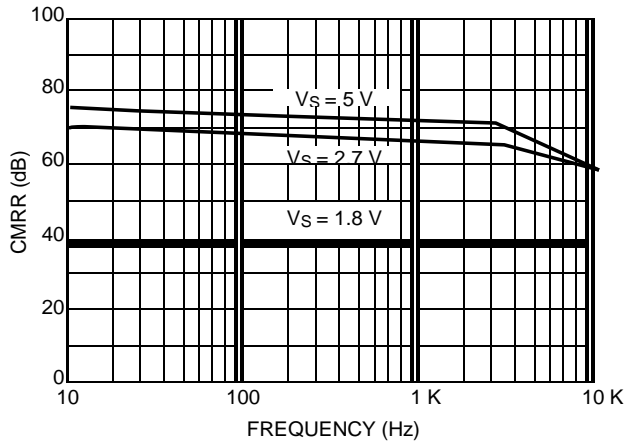

Figure 13. CMRR vs. Frequency

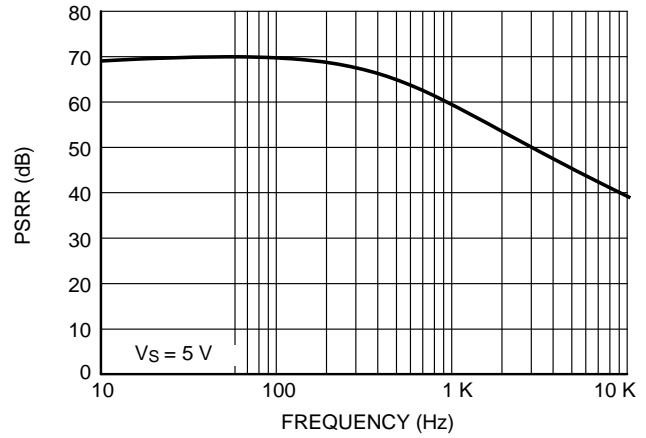

Figure 14. PSRR vs. Frequency

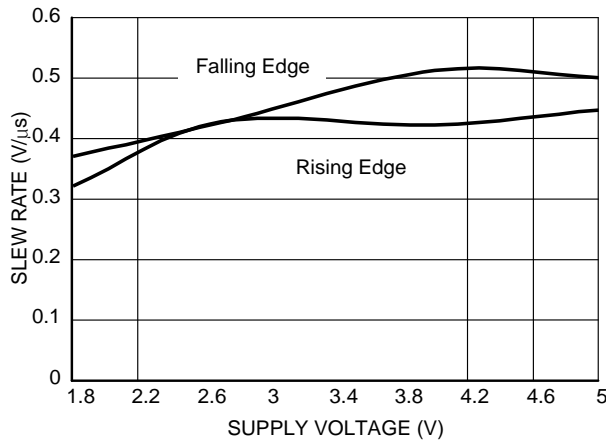
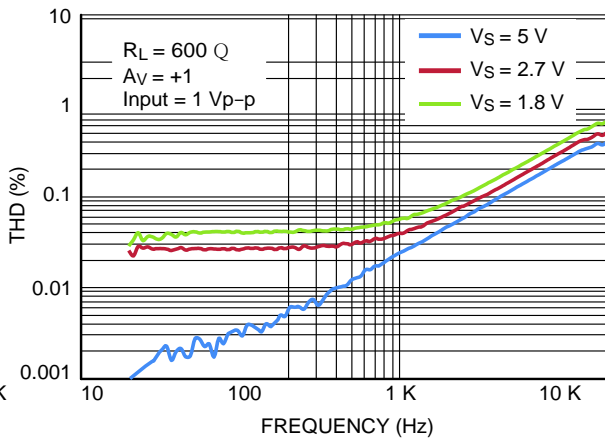
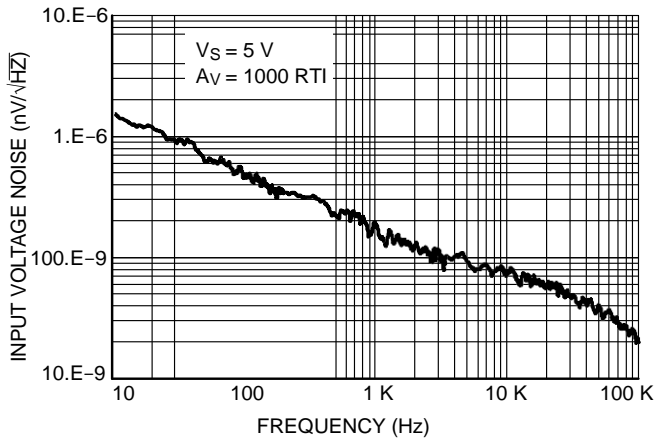
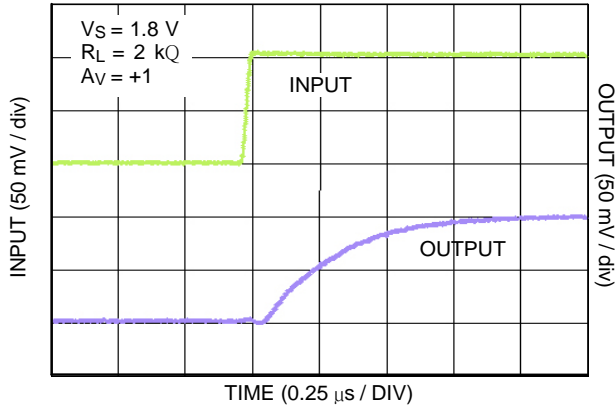
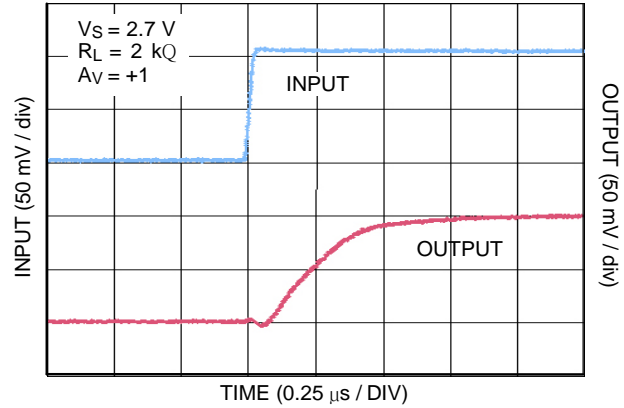
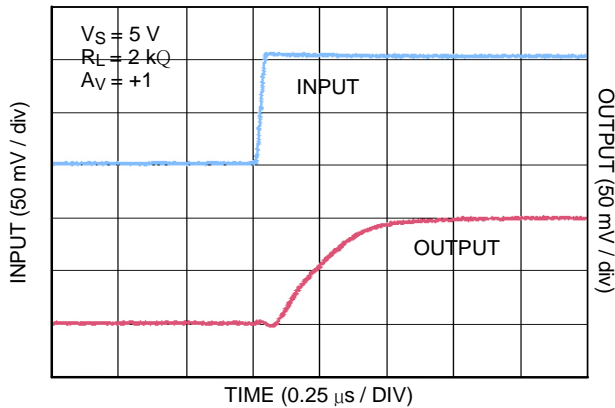
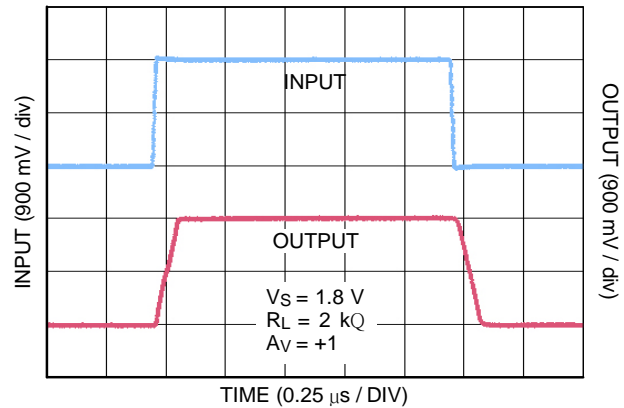
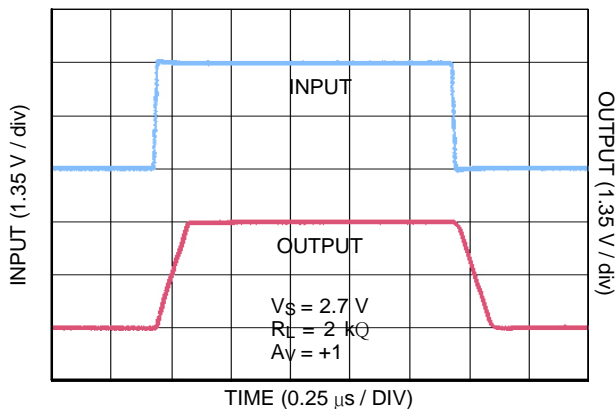
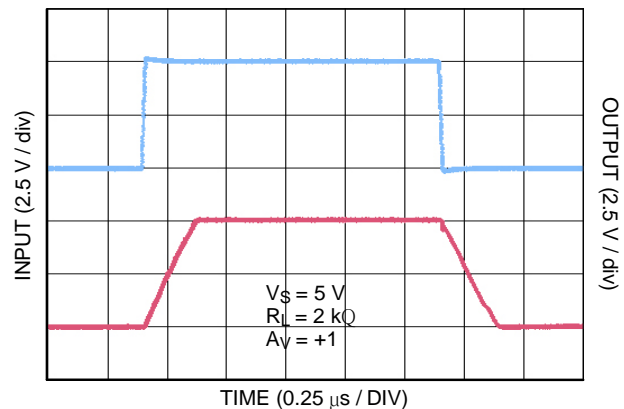

Figure 17. Slew Rate vs. Supply Voltage

TYPICAL CHARACTERISTICS

 ($T_A = 25^\circ\text{C}$ and $V_S = 5\text{ V}$ unless otherwise specified)

Figure 18. Small Signal Transient Response

Figure 19. Small Signal Transient Response

Figure 20. Small Signal Transient Response

Figure 21. Large Signal Transient Response

Figure 22. Large Signal Transient Response

Figure 23. Large Signal Transient Response

TYPICAL CHARACTERISTICS

($T_A = 25^\circ\text{C}$ and $V_S = 5\text{ V}$ unless otherwise specified)

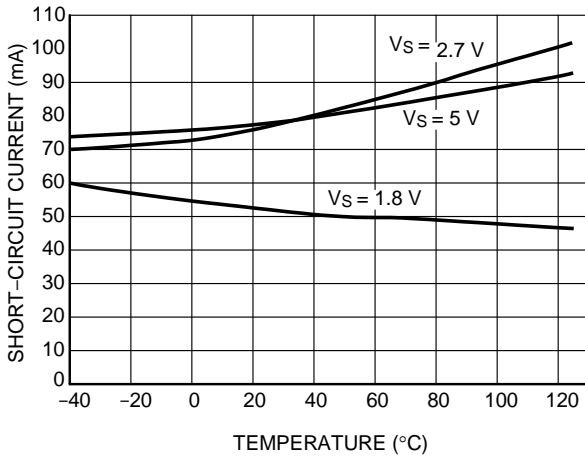

Figure 24. Short-Circuit vs. Temperature (Sinking)

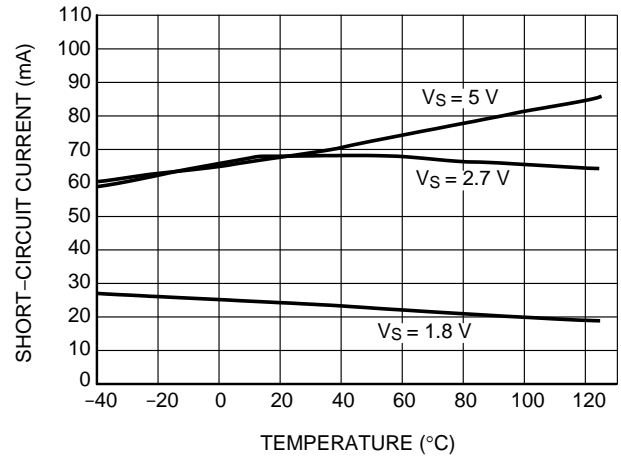

Figure 25. Short-Circuit vs. Temperature (Sourcing)

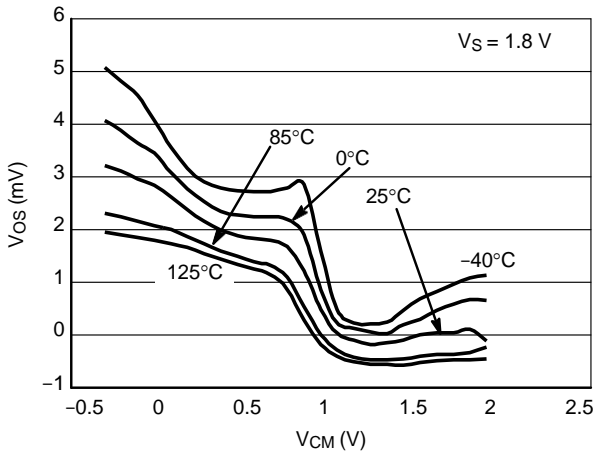

Figure 26. Offset Voltage vs. Common Mode Range V_{DD}

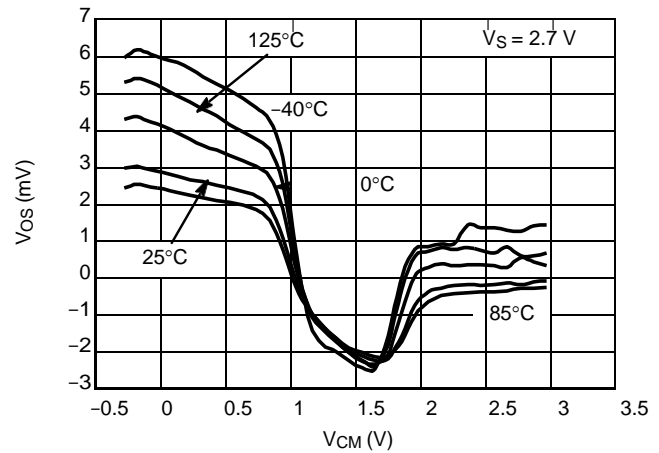

Figure 27. Offset Voltage vs. Common Mode Range

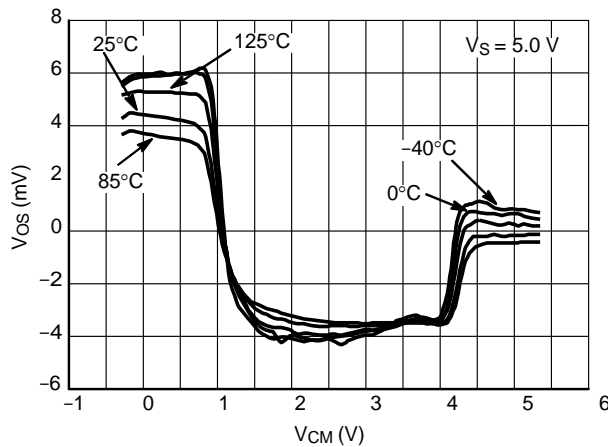

Figure 28. Offset Voltage vs. Common Mode Range

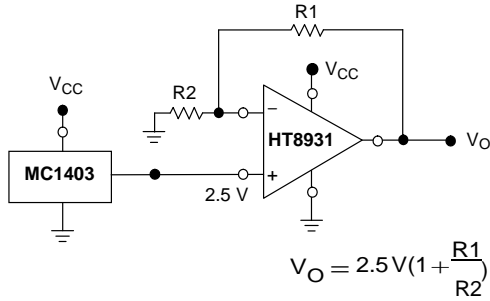

Figure 29. Voltage Reference

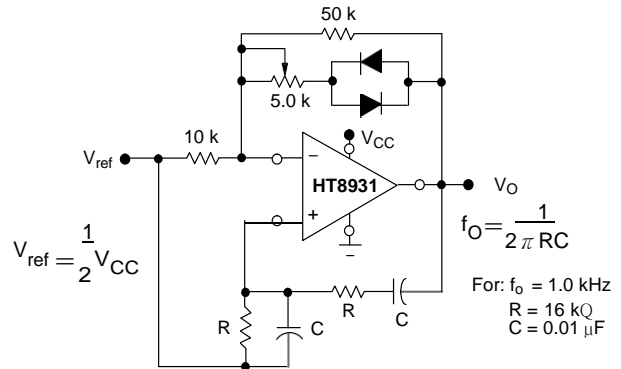

Figure 30. Wien Bridge Oscillator

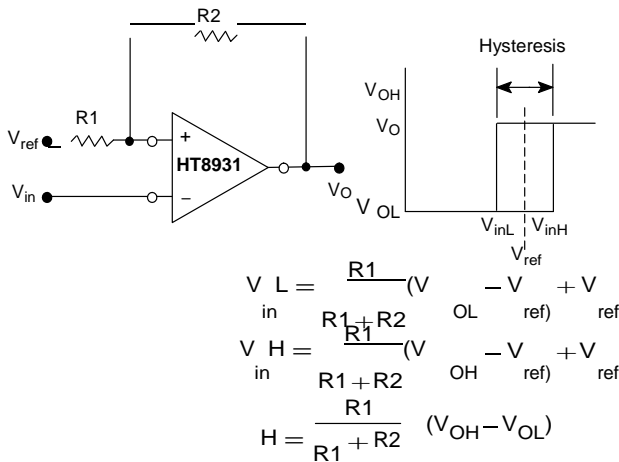
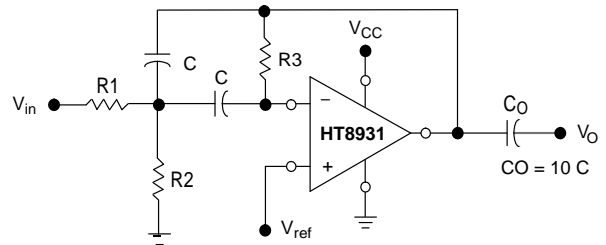

Figure 31. Comparator with Hysteresis



Given: f_o = center frequency
 $A(f_o)$ = gain at center frequency

Choose value f_o, Q

Then: $R3 = \frac{1}{\pi f_o C}$

$$R1 = \frac{R3}{2 A(f_o)}$$

$$R2 = \frac{R1 R3}{4Q^2 R1 - R3}$$

For less than 10% error from operational amplifier,
 $((Q_o f_o)/BW) < 0.1$ where f_o and BW are expressed in Hz.
 If source impedance varies, filter may be preceded with
 voltage follower buffer to stabilize filter parameters.

Figure 32. Multiple Feedback Bandpass Filter

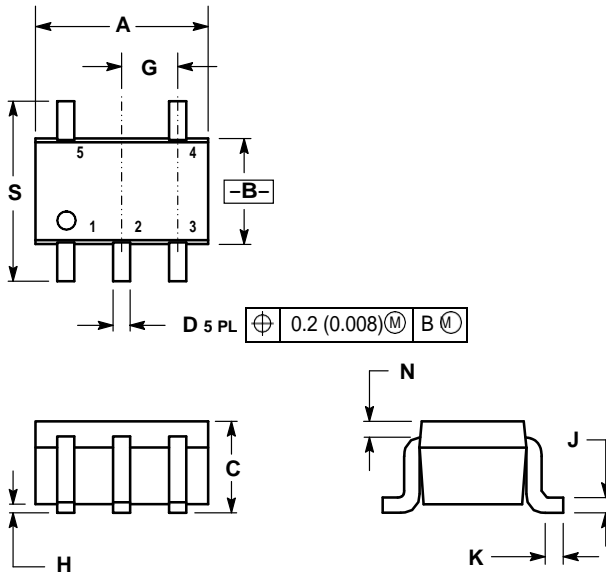

SCALE 2:1

SC-88A (SC-70-5/SOT-353)
 CASE 419A-02
 ISSUE L

NOTES:

1. DIMENSIONING AND TOLERANCING PER ANSI Y14.5M, 1982.
2. CONTROLLING DIMENSION: INCH.
3. 419A-01 OBSOLETE. NEW STANDARD 419A-02.
4. DIMENSIONS A AND B DO NOT INCLUDE MOLD FLASH, PROTRUSIONS, OR GATE BURRS.

DIM	INCHES		MILLIMETERS	
	MIN	MAX	MIN	MAX
A	0.071	0.087	1.80	2.20
B	0.045	0.053	1.15	1.35
C	0.031	0.043	0.80	1.10
D	0.004	0.012	0.10	0.30
G	0.026 BSC		0.65 BSC	
H	---	0.004	---	0.10
J	0.004	0.010	0.10	0.25
K	0.004	0.012	0.10	0.30
N	0.008 REF		0.20 REF	
S	0.079	0.087	2.00	2.20

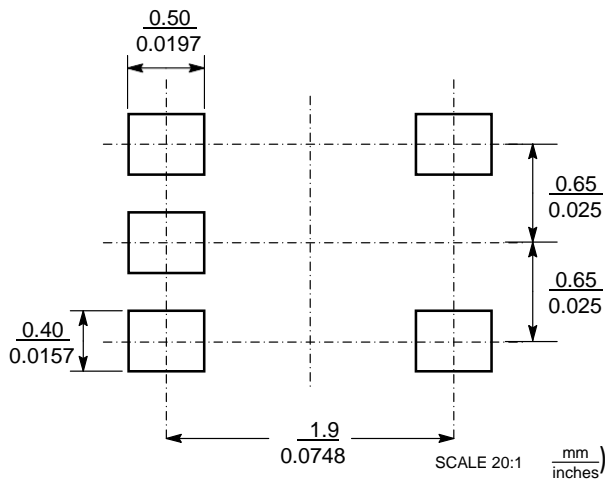
SOLDER FOOTPRINT

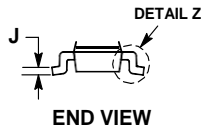
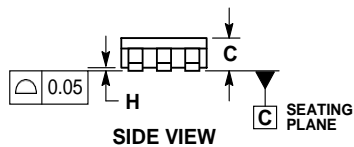
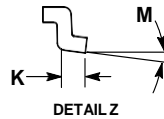
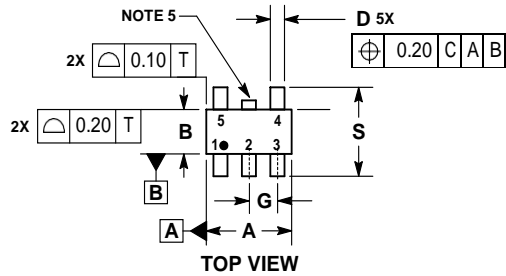

SCALE 2:1

SOT23 5 -
 CASE 483
 ISSUE N

NOTES:

1. DIMENSIONING AND TOLERANCING PER ASME Y14.5M, 1994.
2. CONTROLLING DIMENSION: MILLIMETERS.
3. MAXIMUM LEAD THICKNESS INCLUDES LEAD FINISH THICKNESS. MINIMUM LEAD THICKNESS IS THE MINIMUM THICKNESS OF BASE MATERIAL.
4. DIMENSIONS A AND B DO NOT INCLUDE MOLD FLASH, PROTRUSIONS, OR GATE BURRS. MOLD FLASH, PROTRUSIONS, OR GATE BURRS SHALL NOT EXCEED 0.15 PER SIDE. DIMENSION A.
5. OPTIONAL CONSTRUCTION: AN ADDITIONAL TRIMMED LEAD IS ALLOWED IN THIS LOCATION. TRIMMED LEAD NOT TO EXTEND MORE THAN 0.2 FROM BODY.

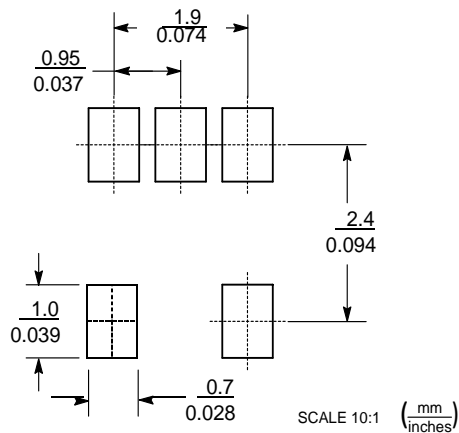
DIM	MILLIMETERS	
	MIN	MAX
A	2.85	3.15
B	1.35	1.65
C	0.90	1.10
D	0.25	0.50
G	0.95 BSC	
H	0.01	0.10
J	0.10	0.26
K	0.20	0.60
M	0	10
S	2.50	3.00

SOLDERING FOOTPRINT*

*For additional information on our Pb-Free strategy and soldering details, please download the ON Semiconductor Soldering and Mounting Techniques Reference Manual, SOLDERRM/D.

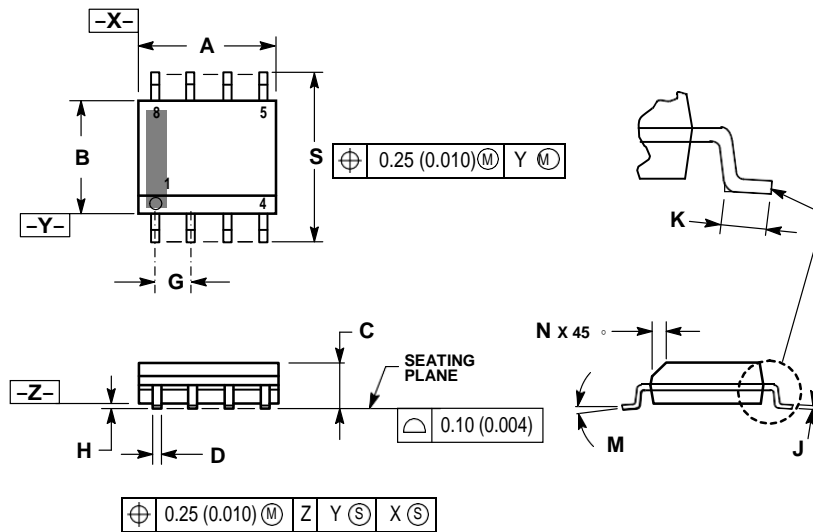

SCALE 1:1

SOIC-8 NB
 CASE 751-07
 ISSUE AK

NOTES:

1. DIMENSIONING AND TOLERANCING PER ANSI Y14.5M, 1982.
2. CONTROLLING DIMENSION: MILLIMETER.
3. DIMENSION A AND B DO NOT INCLUDE MOLD PROTRUSION.
4. MAXIMUM MOLD PROTRUSION 0.15 (0.006) PER SIDE.
5. DIMENSION D DOES NOT INCLUDE DAMBAR PROTRUSION. ALLOWABLE DAMBAR PROTRUSION SHALL BE 0.127 (0.005) TOTAL IN EXCESS OF THE D DIMENSION AT MAXIMUM MATERIAL CONDITION.
6. 751-01 THRU 751-06 ARE OBSOLETE. NEW STANDARD IS 751-07.

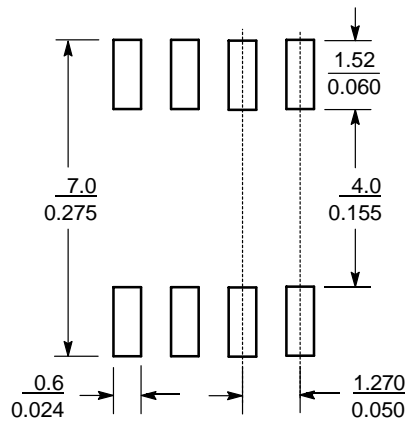
DIM	MILLIMETERS		INCHES	
	MIN	MAX	MIN	MAX
A	4.80	5.00	0.189	0.197
B	3.80	4.00	0.150	0.157
C	1.35	1.75	0.053	0.069
D	0.33	0.51	0.013	0.020
G	1.27 BSC		0.050 BSC	
H	0.10	0.25	0.004	0.010
J	0.19	0.25	0.007	0.010
K	0.40	1.27	0.016	0.050
M	0	8	0	8
N	0.25	0.50	0.010	0.020
S	5.80	6.20	0.228	0.244

SOLDERING FOOTPRINT*

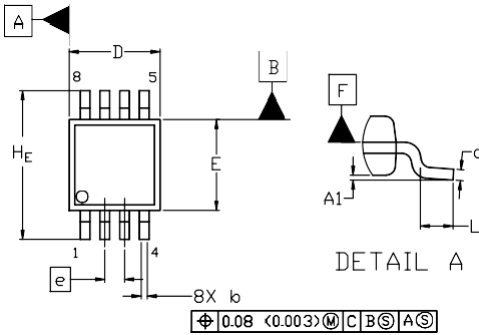
 SCALE 6:1 $\left(\frac{\text{mm}}{\text{inches}}\right)$

*For additional information on our Pb-Free strategy and soldering details, please download the ON Semiconductor Soldering and Mounting Techniques Reference Manual, SOLDERRM/D.

SCALE 2:1
Micro8
CASE 846A-02
ISSUE K

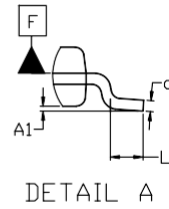
TOP VIEW

NOTE 3

DETAIL A
NOTES:

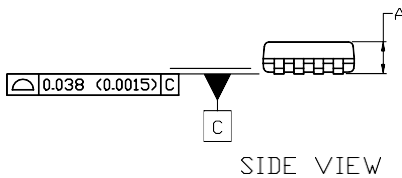
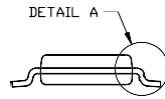
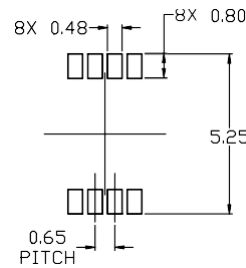
1. DIMENSIONING AND TOLERANCING PER ASME Y14.5M, 2009.
2. CONTROLLING DIMENSION: MILLIMETERS
3. DIMENSION *b* DOES NOT INCLUDE DAMBAR PROTRUSION. ALLOWABLE PROTRUSION SHALL BE 0.10 mm IN EXCESS OF MAXIMUM MATERIAL CONDITION.
4. DIMENSIONS D AND E DO NOT INCLUDE MOLD FLASH, PROTRUSION OR GATE BURRS. MOLD FLASH, PROTRUSIONS, OR GATE BURRS SHALL NOT EXCEED 0.15 mm PER SIDE. DIMENSION E DOES NOT INCLUDE INTERLEAD FLASH OR PROTRUSION. INTERLEAD FLASH OR PROTRUSION SHALL NOT EXCEED 0.25 mm PER SIDE. DIMENSIONS D AND E ARE DETERMINED AT DATUM F.
5. DATUMS A AND B ARE TO BE DETERMINED AT DATUM F.
6. A1 IS DEFINED AS THE VERTICAL DISTANCE FROM THE SEATING PLANE TO THE LOWEST POINT IN THE PACKAGE BODY.

SIDE VIEW

END VIEW

RECOMMENDED MOUNTING FOOTPRINT

DIM	MILLIMETERS		
	MIN.	NOM.	MAX.
A	---	---	1.10
A1	0.05	0.08	0.15
<i>b</i>	0.25	0.33	0.40
<i>c</i>	0.13	0.18	0.23
D	2.90	3.00	3.10
E	2.90	3.00	3.10
<i>e</i>	0.65 BSC		
H _E	4.75	4.90	5.05
L	0.40	0.55	0.70