

SMD CRYSTAL UNIT SPECIFICATIONS

Customer	
Customer P/N	
Product	3225 Seam Sealing Crystal
Nominal Frequency	25.000000MHz
HOSONIC P/N	E3SB25E00000GE
Version	10C0
Issue Date	2020/4/30

HOSONIC		
Drawn	Checked	Approved
LUCY	ZOE	JOHN

Approved By Customer : _____



HOSONIC ELECTRONIC CO., LTD.



Revised Record

Rev.	Rev. Date	Item	Content	Remark
1.0	2020-04-30		Initial released	

● ELECTRICAL PARAMETERS

Electrical characteristics measured by S&A250B or equivalent.

No.	Item	Symb.	Electrical Specification				Remark
			Min.	Typ.	Max.	Units	
1	Nominal Frequency	F0	25.000000			MHz	
2	Mode of Vibration		Fundamental				
3	Frequency Tolerance	$\Delta F/F0$	-20	-	20	ppm	At 25°C±3°C
4	Operating Temperature Range	T _{OPR}	-20	-	70	°C	
5	Frequency Stability (over operating temperature)	TC	-30	-	30	ppm	Ref. to 25°C
6	Storage Temperature	T _{STG}	-55	-	125	°C	
7	Load capacitance	CL	-	10	-	pF	
8	Equivalent Series Resistance	ESR	-	-	50	Ω	
9	Drive Level	DL	-	100	200	μW	
10	Insulation Resistance	IR	500	-	-	MΩ	At 100V _{DC}
11	Shunt Capacitance	C0	-	-	3	pF	
12	Aging Per Year	Fa	-2	-	2	ppm	First Year
13	Package type	E3SB					

NOTE: Storage Temperature is only for the product itself, the temperature for the packing material is -4~40°C.

● STORAGE REQUIREMENT

Storage environmental conditions: -4~40°C, 70%RH max.

Maximum storage time: 24 Months from date of manufacture.

● **OUTLINE DIMENSIONS (UNIT: mm)**

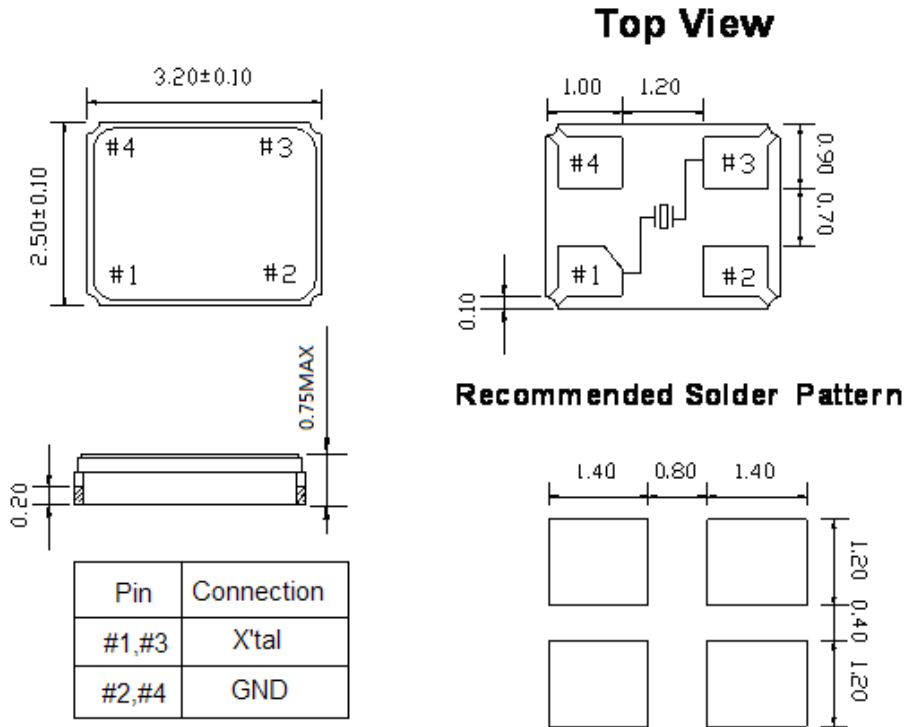

*unlabeled tolerance: $\pm 0.1\text{mm}$

● **MARKING:**

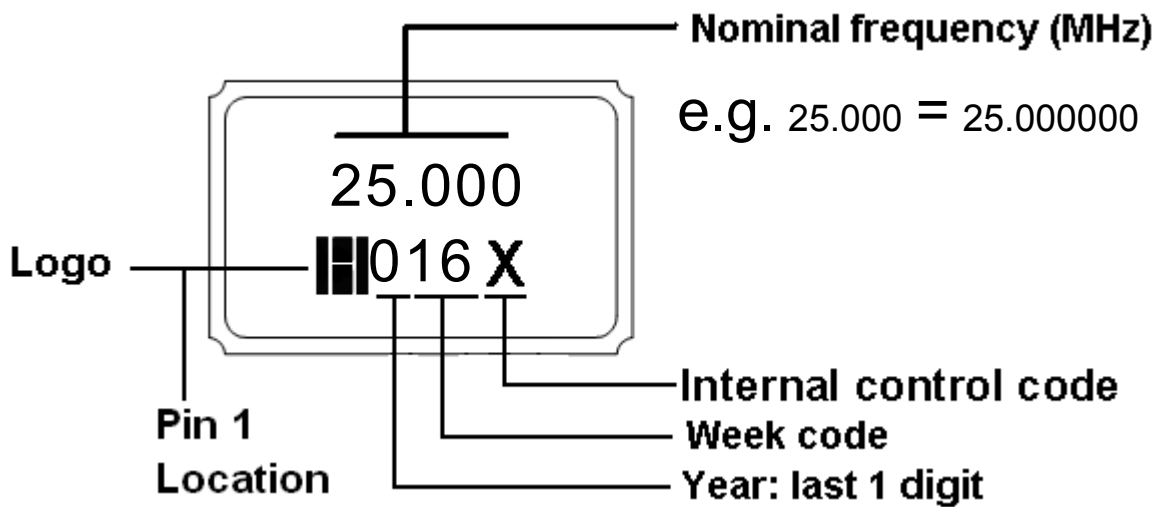

● **PRODUCT LAYOUT**

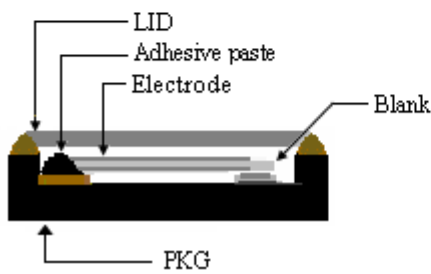
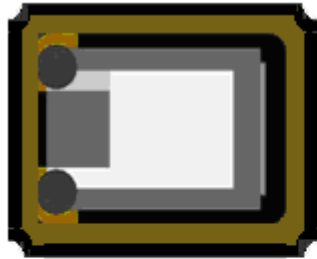

NO.	Part	Material	Remark
1	LID	KOVAR(Fe+Co+Ni alloy)	
2	PKG	Al ₂ O ₃	Base
3	Blank	SiO ₂	Quartz
4	Adhesive paste	Ag/Silicon	Support
5	Electrode	Noble metal	

REFLOW PROFILES

Profiles Feature	Pb-Free Assembly
Average Ramp-up Rate (Ts max to Tp)	3°C/second max.
Preheat	
■ Temperature Min (Ts min)	125°C
■ Temperature Max (Ts max)	200°C
■ Time (ts min to ts max)	60~180 seconds
Time maintained above	
■ Temperature (TL)	217°C
■ Time (tL)	60~150 seconds
Peak/Classification Temperature (Tp)	260°C
Time within 5°C of actual Peak Temperature (tp)	20~40 seconds
Ramp-down rate	6°C/second max.
Time 25°C to Peak Temperature	8 minutes max.
Suggest reflow times	3 Times max



Remark: To reference JEDEC J-STD-020

● **PACKAGE(reference to EIA-481)**

Tape Dimensions(unit : mm)

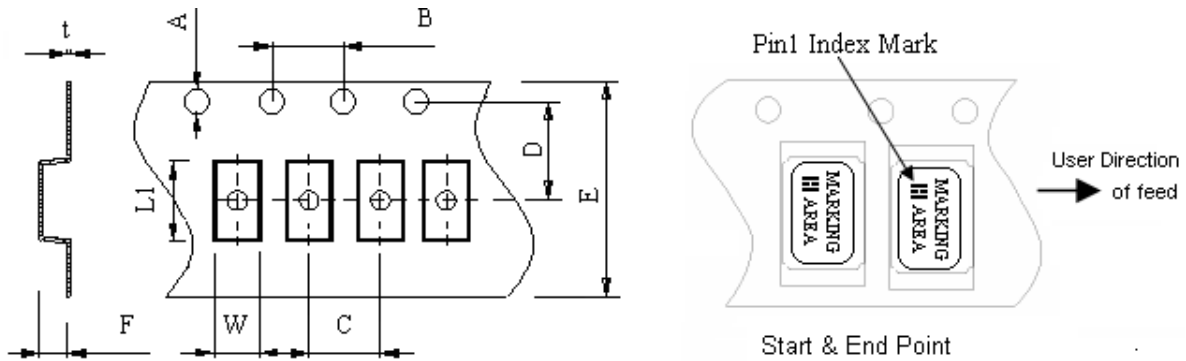

A	B	C	D	E	F	L1	W	t
1.50	4.0	4.0	3.5	8.0	1.0	3.4	2.7	0.3

Reel Dimensions(unit: mm)

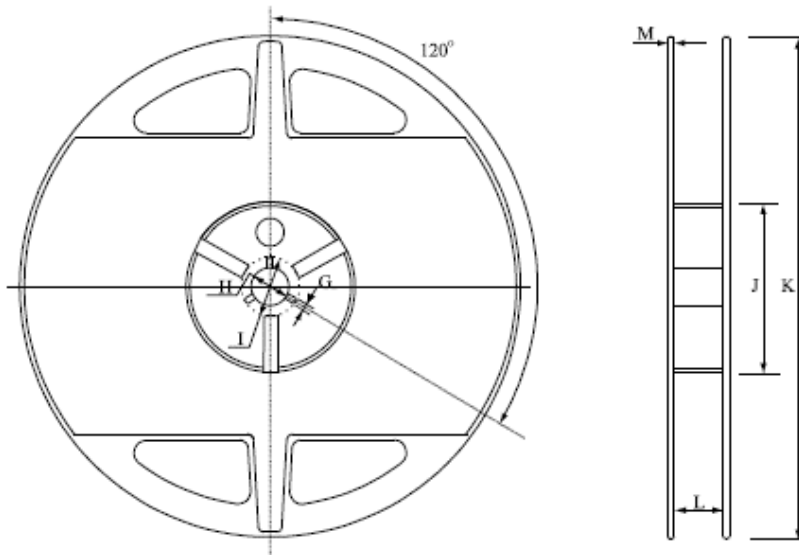

G	H	I	J	K	L	M
2.5	13.5	21.6	60.0	178	9.5	1.6

*3000pcs/Reel

Carton Dimension (unit : mm)



1 reel = 1 Inner box

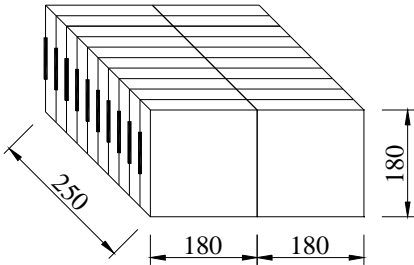

20 Inner boxes = 1 Carton

60kpcs = 1 Carton

- **RELIABILITY SPECIFICATIONS**

No.	Test Item	Test Conditions	Reference
1	High Temperature Storage	Temperature: 125°C ± 3°C Time: 1000 ± 12 Hours	MIL-STD-202 Method 108
2	Temperature Cycle	Temperature 1: -55°C ± 3°C Temperature 2: 125°C ± 3°C Temperature change between T1 and T2 at soonest Run 1000 cycles, maintain T1 and T2 5minutes each in one cycle	JESD22 Method JA-104
3	Solder Heat Resistance	Pre-heat: 125°C 60~120 Seconds Solder Temperature: 260°C ± 5°C Time: 30 Seconds	MIL-STD-202 Method 210
4	Drop Test	3 Times Free Fall from 150cm height to concrete floor.	IEC 68-2-32
5	High Temperature, High Humidity Storage	Temperature: 85°C ± 5°C Relative Humidity: 80%--85% Time: 250Hours ± 12 Hours	MIL-STD-202 Method 103
6	Steam Aging	Temperature: 97°C ± 3°C Time: 24 Hours 260°C solder pot to check solderability	J-STD-002
7	Solderability	Dip in flux 5~10 seconds Temperature: 245°C ± 5°C Time: 10 Seconds	J-STD-002
8	Aging	Temperature: 85°C ± 2°C Time: 250 ± 12Hours	MIL-STD-202 Method 108
9	Thermal Shock	Temperature 1: -55°C ± 3°C Temperature 2: 125°C ± 3°C Temperature change between T1 and T2: 5 seconds 100 cycles, maintain T1 and T2 for 30 minutes each in one cycle	MIL-STD-202 Method 107
10	Vibration	Frequency Range: 10Hz~2000Hz Amplitude: 1.5mm or 20G 4Hours in each direction, total 12Hours	MIL-STD-202 Method 204