

AT7812TO

3-Terminal Voltage Regulator

TO-220

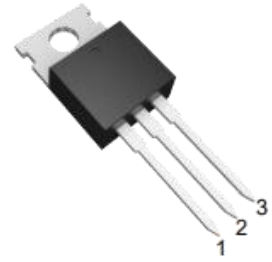

Features

- Output current up to 1.5A
- Output voltage of 12V
- Continuous total dissipation internally limited

Absolute Maximum Ratings($T_a=25^{\circ}\text{C}$)

1. Input 2. Ground 3. Output

Parameter	Symbols	Value	Units
Input Voltage	V_I	35	V
Output Current	I_O	1.5	A
Operating Virtual Junction Temperature	T_J	150	$^{\circ}\text{C}$
Power Dissipation	P_D	1.25	W
Storage Temperature Range	T_{STG}	-55~150	$^{\circ}\text{C}$

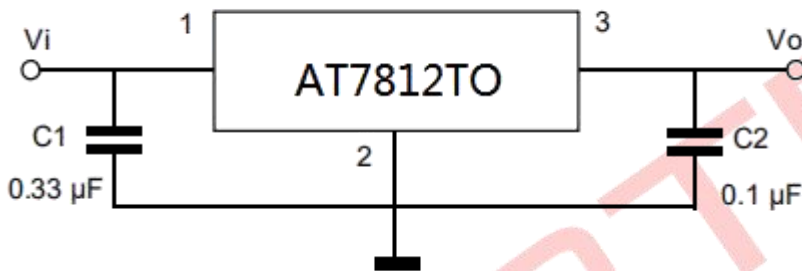

Electrical Characteristics($T_a=25^{\circ}\text{C}$, $V_I=10\text{V}$, $I_O=500\text{mA}$, $C_i=0.33\mu\text{F}$, $C_o=0.1\mu\text{F}$, unless otherwise specified)

Parameter	Symbols	Test Conditions	Min	Typ	Max	Unit
Output Voltage	V_O	$T_j=25^{\circ}\text{C}$	11.75	12	12.25	V
		$V_i=14.5\text{V to }25\text{V}, I_o=5\text{mA to }1\text{A}$	11.5	12	12.5	V
		$I_o=1\text{A}, V_i=25\text{V to }27\text{V}, T_j=25^{\circ}\text{C}$	11.5	12	12.5	V
Input Regulation	ΔV_O	$V_i=14.5\text{V to }30\text{V}, I_o=500\text{mA}, T_j=25^{\circ}\text{C}$			120	mV
		$V_i=14.5\text{V to }27\text{V}, T_j=25^{\circ}\text{C}$			120	mV
Output Regulation	ΔV_O	$I_o=5\text{mA to }1.5\text{A}, T_j=25^{\circ}\text{C}$			100	mV
		$I_o=250\text{mA to }750\text{mA}, T_j=25^{\circ}\text{C}$			50	mV
Ripple Rejection	RR	$V_i=15\text{V to }25\text{V}, T_j=25^{\circ}\text{C}, f=120\text{HZ}$		60		dB
Output Noise Voltage	V_N	$F=10\text{Hz}\sim 100\text{KHz}, T_j=25^{\circ}\text{C}$		10		μV
Dropout Voltage	V_D	$T_j=25^{\circ}\text{C}, I_o=1\text{A}$		2		V
Quiescent Current	I_Q	$T_j=25^{\circ}\text{C}$		4.4	6	mA
Quiescent Current Change	ΔI_Q	$I_o=5\text{mA to }1\text{A}$			0.5	mA
		$V_i=15\text{V to }30\text{V}, I_o=500\text{mA}$			0.8	mA
Short Circuit Current Limit	I_{SC}	$V_i=35\text{V}, T_j=25^{\circ}\text{C}$		200		mA

AT7812TO

Ratings and Characteristic Curves

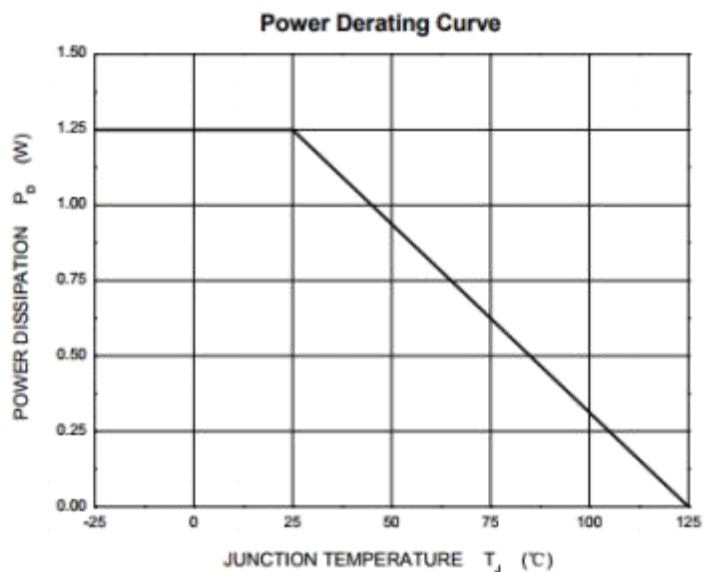
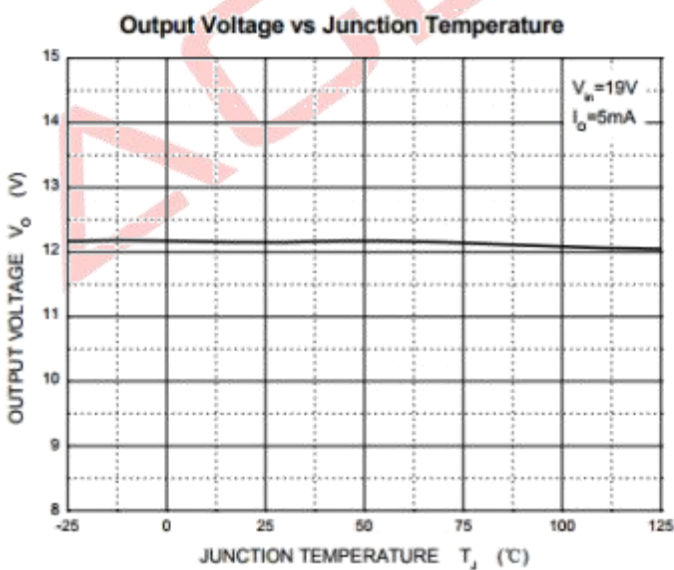
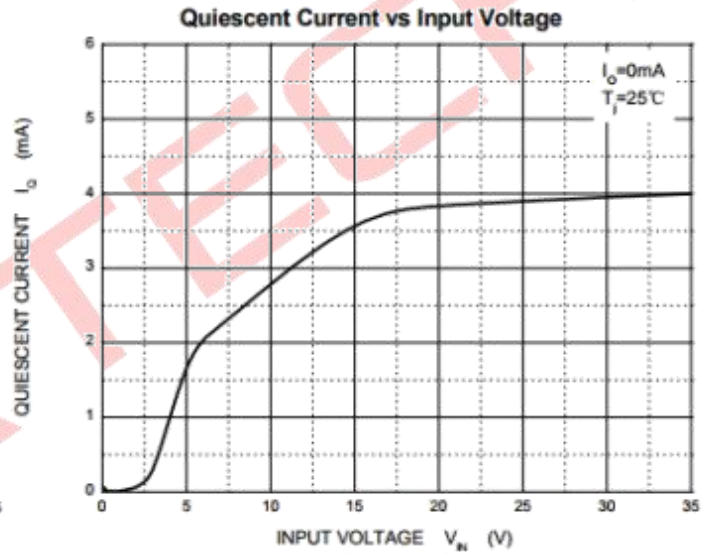
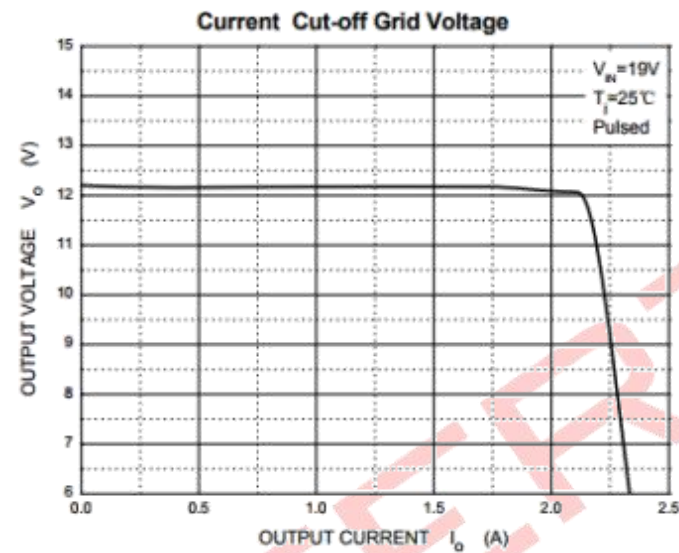
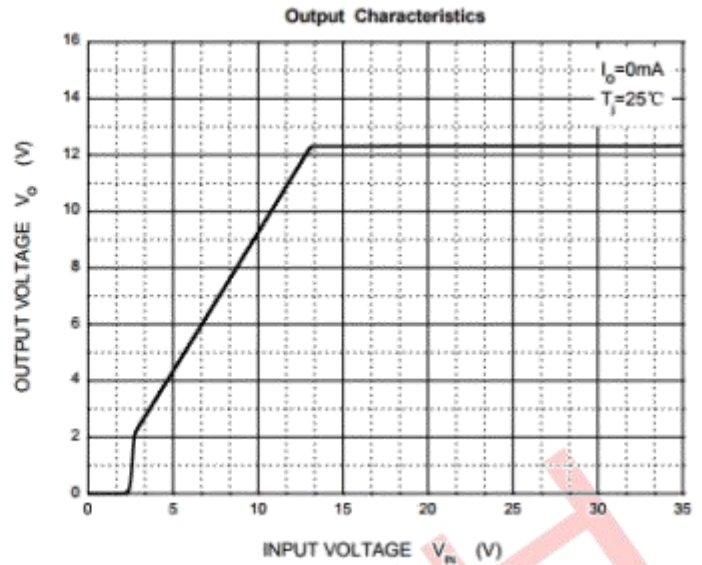
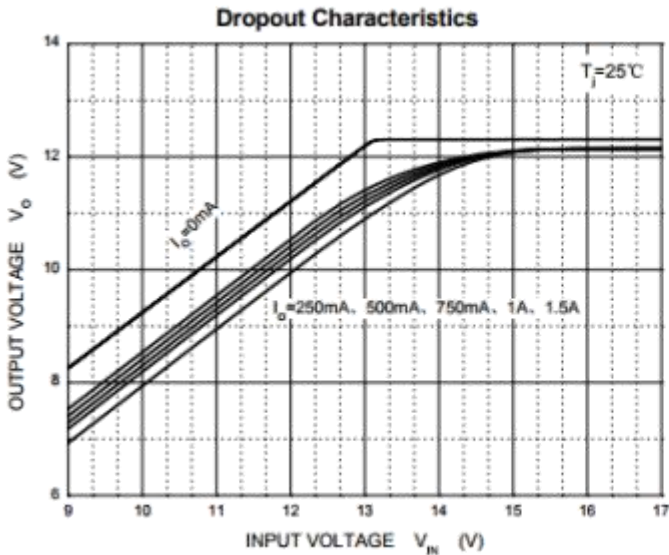

AT7812TO

Package Outline

TO-220

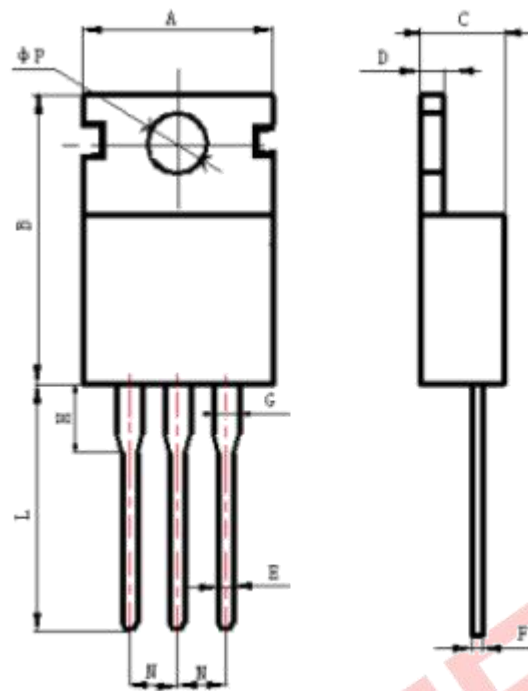

Dimensions in mm

Dimensions	Dimensions In Inches	
	Min.	Max.
A	9.90	10.10
B	15.60	15.90
C	4.40	4.60
D	1.30	1.35
E	0.65	0.85
F	0.5	0.6
G	1.26	1.29
H	3.00	3.38
L	13.0	13.67
N	2.24	2.54
ϕP	3.84	3.87