

# MSKSEMI

SEMICONDUCTOR



ESD



TVS



TSS



MOV



GDT



PLED

Product data sheet

**FEATURES**

- Extremely Fast Switching Speed
- Low forward voltage

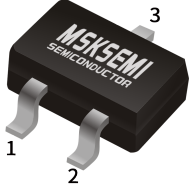

**SOT-323**

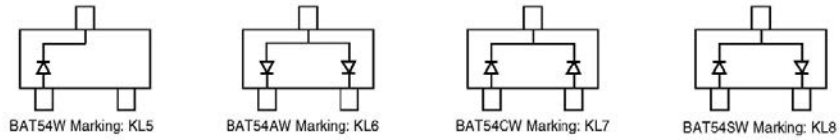

**MARKING:**

BAT54W	BAT54AW	BAT54CW	BAT54SW

**MAXIMUM RATINGS ( T<sub>a</sub>=25°C unless otherwise noted )**

Parameter	Symbol	Value	Unit
Peak Repetitive Reverse Voltage	V <sub>RRM</sub>	30	V
Working Peak Reverse Voltage	V <sub>RWM</sub>		
DC Blocking Voltage	V <sub>R</sub>		
Forward Continuous Current	I <sub>FM</sub>	200	mA
Non-repetitive Peak Forward Surge Current @t=8.3ms	I <sub>FSM</sub>	600	mA
Repetitive Peak Forward Current @ t≤1s, δ ≤0.5	I <sub>FRM</sub>	300	mA
Power Dissipation	P <sub>D</sub>	200	mW
Thermal Resistance from Junction to Ambient	R <sub>θJA</sub>	500	°C/W
Operating Junction Temperature Range	T <sub>j</sub>	-40 ~ +125	°C
Storage Temperature Range	T <sub>stg</sub>	-55 ~ +150	°C

**ELECTRICAL CHARACTERISTICS(T<sub>a</sub>=25°C unless otherwise specified)**

Parameter	Symbol	Test conditions	Min	Typ	Max	Unit
Reverse voltage	V <sub>(BR)</sub>	I <sub>R</sub> =100μA	30			V
Reverse current	I <sub>R</sub>	V <sub>R</sub> =25V			2	μA
Forward voltage	V <sub>F</sub>	I <sub>F1</sub> =0.1mA			0.24	V
		I <sub>F2</sub> =1mA			0.32	V
		I <sub>F3</sub> =10mA			0.40	V
		I <sub>F4</sub> =30mA			0.50	V
		I <sub>F5</sub> =100mA			1	V
Diode capacitance	C <sub>D</sub>	V <sub>R</sub> =1V, f=1MHz			10	pF
Reverse recovery time	t <sub>rr</sub>	I <sub>F</sub> =I <sub>R</sub> =10mA I <sub>rr</sub> =0.1×I <sub>R</sub> ,R <sub>L</sub> =100Ω			5	ns

**Forward Characteristics**

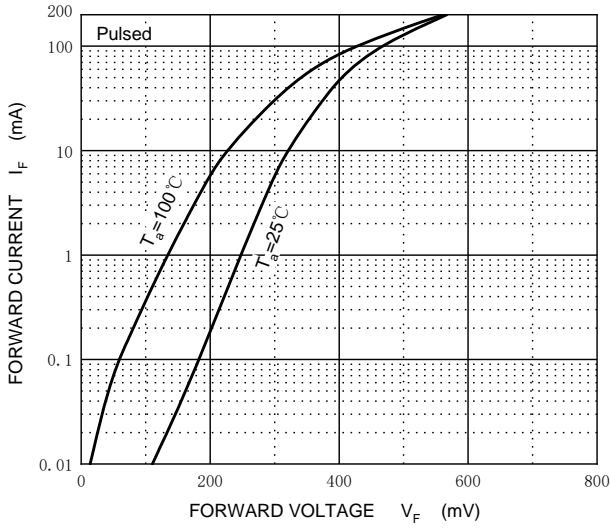

**Reverse Characteristics**

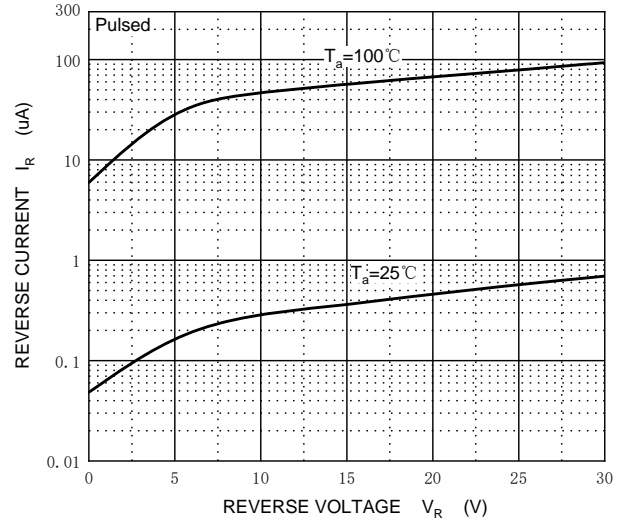

**Capacitance Characteristics**

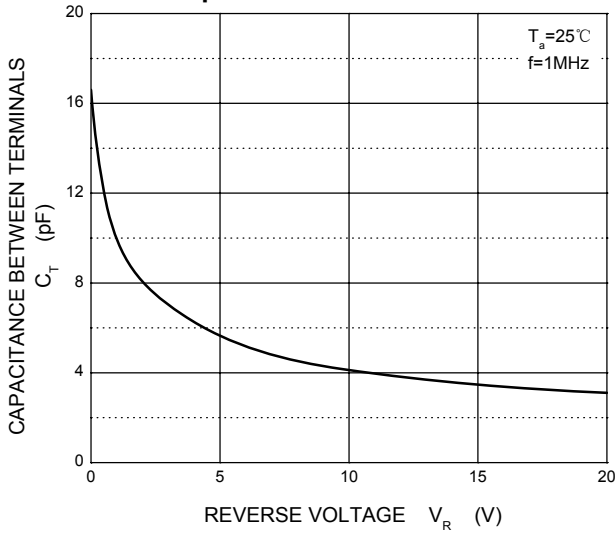

**Power Derating Curve**

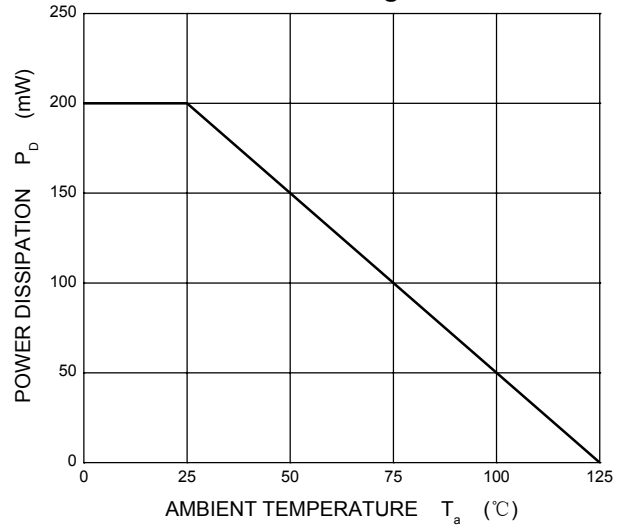

**PACKAGE MECHANICAL DATA**

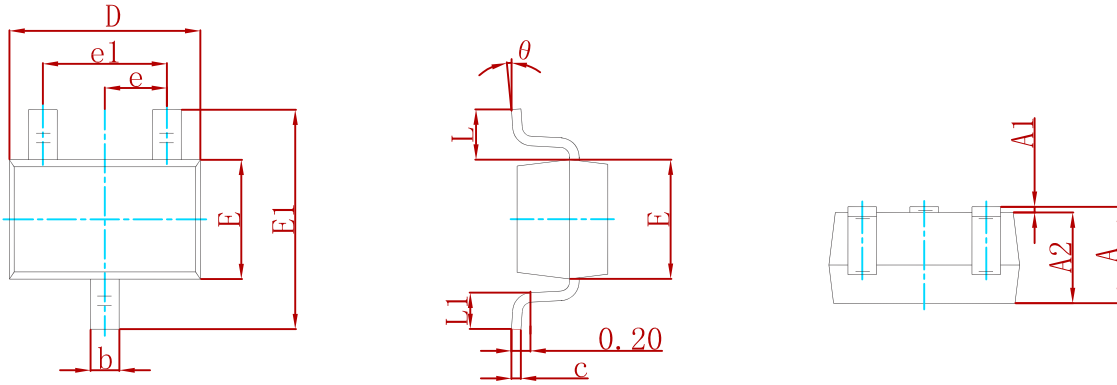

Symbol	Dimensions In Millimeters		Dimensions In Inches	
	Min	Max	Min	Max
A	0.900	1.100	0.035	0.043
A1	0.000	0.100	0.000	0.004
A2	0.900	1.000	0.035	0.039
b	0.200	0.400	0.008	0.016
c	0.080	0.150	0.003	0.006
D	2.000	2.200	0.079	0.087
E	1.150	1.350	0.045	0.053
E1	2.150	2.450	0.085	0.096
e	0.650 TYP		0.026 TYP	
e1	1.200	1.400	0.047	0.055
L	0.525 REF		0.021 REF	
L1	0.260	0.460	0.010	0.018
θ	0°	8°	0°	8°

**Suggested Pad Layout**

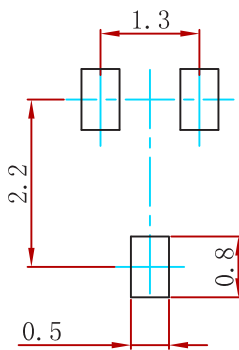

Note:  
 1. Controlling dimension: in millimeters.  
 2. General tolerance: ±0.05mm.  
 3. The pad layout is for reference purposes only.

**REEL SPECIFICATION**

P/N	PKG	QTY
BAT54AW	SOT-323	3000

## Attention

- Any and all MSKSEMI Semiconductor products described or contained herein do not have specifications that can handle applications that require extremely high levels of reliability, such as life-support systems, aircraft's control systems, or other applications whose failure can be reasonably expected to result in serious physical and/or material damage. Consult with your MSKSEMI Semiconductor representative nearest you before using any MSKSEMI Semiconductor products described or contained herein in such applications.
- MSKSEMI Semiconductor assumes no responsibility for equipment failures that result from using products at values that exceed, even momentarily, rated values (such as maximum ratings, operating condition ranges, or other parameters) listed in products specifications of any and all MSKSEMI Semiconductor products described or contained herein.
- Specifications of any and all MSKSEMI Semiconductor products described or contained herein stipulate the performance, characteristics, and functions of the described products in the independent state, and are not guarantees of the performance, characteristics, and functions of the described products as mounted in the customer's products or equipment. To verify symptoms and states that cannot be evaluated in an independent device, the customer should always evaluate and test devices mounted in the customer's products or equipment.
- MSKSEMI Semiconductor strives to supply high-quality high-reliability products. However, any and all semiconductor products fail with some probability. It is possible that these probabilistic failures could give rise to accidents or events that could endanger human lives, that could give rise to smoke or fire, or that could cause damage to other property. When designing equipment, adopt safety measures so that these kinds of accidents or events cannot occur. Such measures include but are not limited to protective circuits and error prevention circuits for safe design, redundant design, and structural design.
- In the event that any or all MSKSEMI Semiconductor products (including technical data, services) described or contained herein are controlled under any of applicable local export control laws and regulations, such products must not be exported without obtaining the export license from the authorities concerned in accordance with the above law.
- No part of this publication may be reproduced or transmitted in any form or by any means, electronic or mechanical, including photocopying and recording, or any information storage or retrieval system, or otherwise, without the prior written permission of MSKSEMI Semiconductor.
- Information (including circuit diagrams and circuit parameters) herein is for example only ; it is not guaranteed for volume production. MSKSEMI Semiconductor believes information herein is accurate and reliable, but no guarantees are made or implied regarding its use or any infringement of intellectual property rights or other rights of third parties.
- Any and all information described or contained herein are subject to change without notice due to product/technology improvement, etc. When designing equipment, refer to the "Delivery Specification" for the MSKSEMI Semiconductor product that you intend to use.