

MSKSEMI

SEMICONDUCTOR

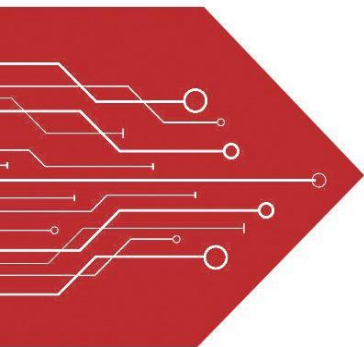

ESD



TVS



TSS



MOV



GDT



PLED

Product data sheet

PIN CONFIGURATION

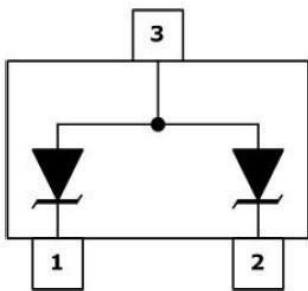
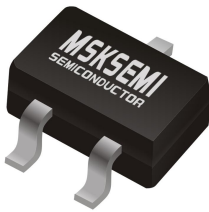

SOT-23

FEATURES

- SOT-23 package allows either two separate unidirectional configurations or a single bidirectional configuration.
- Working peak reverse voltage 3V to 22V
- Standard Zener breakdown voltage 5.6V to 27V
- Peak power 24 or 40 Watts @ 1.0ms (unidirectional) per Figure 6 Waveform
- ESD Rating:
 - Class 3B (>16kV) per the Human Body Model
 - Class C (>400V) per Machine Model
- ESD Rating of IEC61000-4-2 level 4, ± 30 kV contact Discharge
- Low leakage < 5.0 μ A

MACHANICAL DATA

- SOT-23 package
- Flammability Rating: UL 94V-0
- Packaging: Tape and Reel
- High temperature soldering guaranteed: 260°C/10s
- Reel size: 7 inch

APPLICATIONS

- Computers
- Printers
- Business Machines
- Communication systems
- Medical equipment

ABSOLUTE MAXIMUM RATING

Symbol	Parameter	Value	Units
P _{PK}	Peak Power Dissipation @1.0ms		
	MMBZ5V6AL-MS thru MMBZ9V1AL-MS	24	W
	MMBZ12VAL-MS thru MMBZ27VAL-MS	40	
P _D	Total Power Dissipation	200	mW
T _{OPT}	Operating Temperature	-55/+150	°C
T _{STG}	Storage Temperature	-55/+150	°C

24 WATTS
ELECTRICAL CHARACTERISTICS (T_{amb}=25°C)
UNIDIRECTIONAL (Circuit tied to Pins 1 and 3 or Pins 2 to 3)

P/N	Marking	V _{RWM}	I _R	V _{BR}			Z _{ZT}	Z _{ZK}		V _C		
		(V)	(μA)	(V)			(Ω)	(Ω)	(mA)	(V)	(A)	
			@ V _{RWM}	Min	Nom	Max	@ I _T	Max @I _{ZT}	Max	@ I _{ZK}	Max	@ I _{PP}
MMBZ5V6ALT1G-MS	5A6+code	3.0	5.0	5.32	5.6	5.88	20	11	1600	0.25	8.0	3.0
MMBZ6V2ALT1G-MS	6A2+code	3.0	0.5	5.89	6.2	6.51	1.0	--	--	--	8.7	2.76
MMBZ6V8ALT1G-MS	6A8+code	4.5	0.5	6.46	6.8	7.14	1.0	--	--	--	9.6	2.5
MMBZ9V1ALT1G-MS	9A1+code	6.0	0.3	8.65	9.1	9.56	1.0	--	--	--	14	1.7

 V_F=0.9V Max @ I_F=10mA

40 WATTS
ELECTRICAL CHARACTERISTICS (T_{amb}=25°C)
UNIDIRECTIONAL (Circuit tied to Pins 1 and 3 or Pins 2 to 3)

P/N	Marking	V _{RWM}	I _R	V _{BR}				V _C (note1)	
		(V)	(nA)	(V)			(mA)	(V)	(A)
			@ V _{RWM}	Min	Nom	Max	@ I _T	Max	@ I _{PP}
MMBZ12VALT1G-MS	12A+code	8.5	200	11.40	12	12.60	1	17	2.35
MMBZ15VALT1G-MS	15A+code	12.0	50	14.25	15	15.75	1	21	1.90
MMBZ18VALT1G-MS	18A+code	14.5	50	17.10	18	18.90	1	25	1.60
MMBZ20VALT1G-MS	20A+code	16.0	50	19	20	21	1	38	1.0
MMBZ27VALT1G-MS	27A+code	22.0	50	25.65	27	28.35	1	40	1.0

 V_F=0.9V Max @ I_F=10mA

Note 1: Surge Current waveform per Figure 5

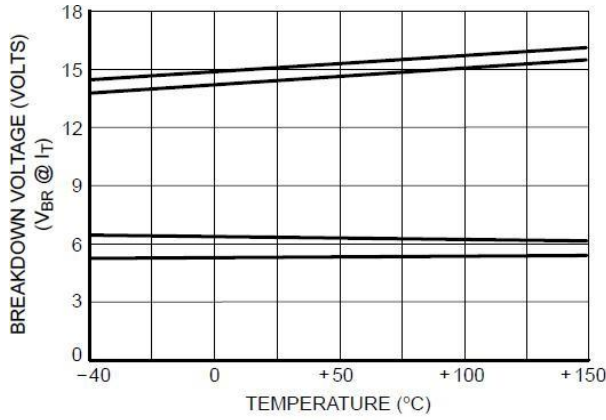

Figure 1. Typical Breakdown Voltage versus Temperature

(Upper curve for each voltage is bidirectional mode, lower curve is unidirectional mode)

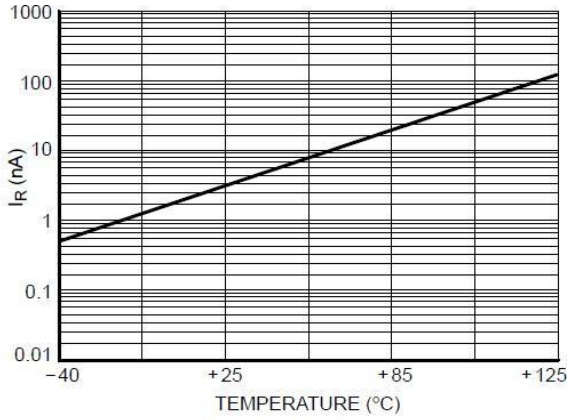

Figure 2. Typical Leakage Current versus Temperature

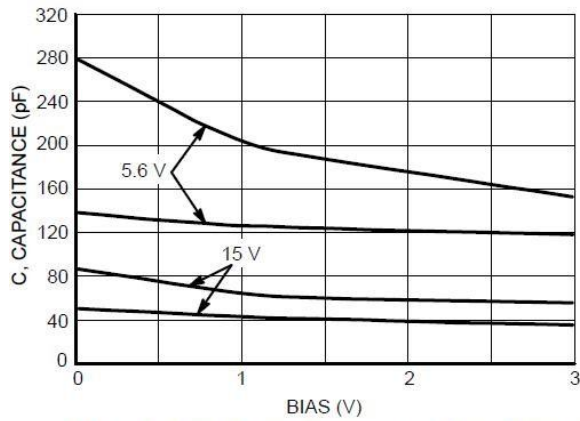

Figure 3. Typical Capacitance versus Bias Voltage

(Upper curve for each voltage is unidirectional mode, lower curve is bidirectional mode)

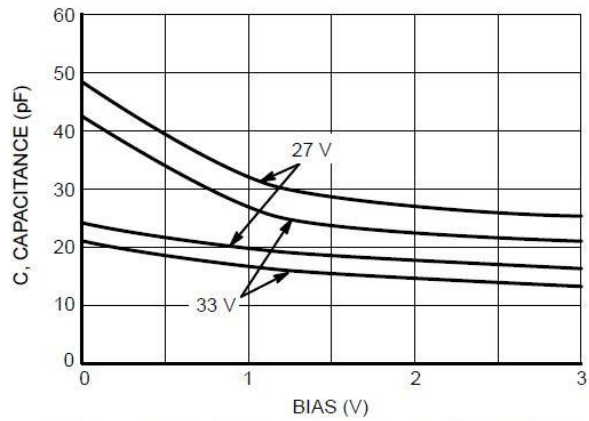

Figure 4. Typical Capacitance versus Bias Voltage

(Upper curve for each voltage is unidirectional mode, lower curve is bidirectional mode)

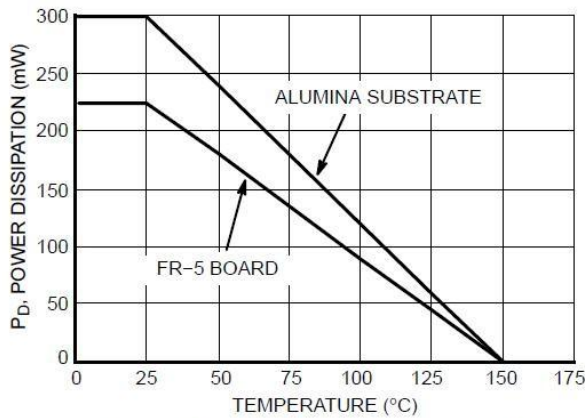
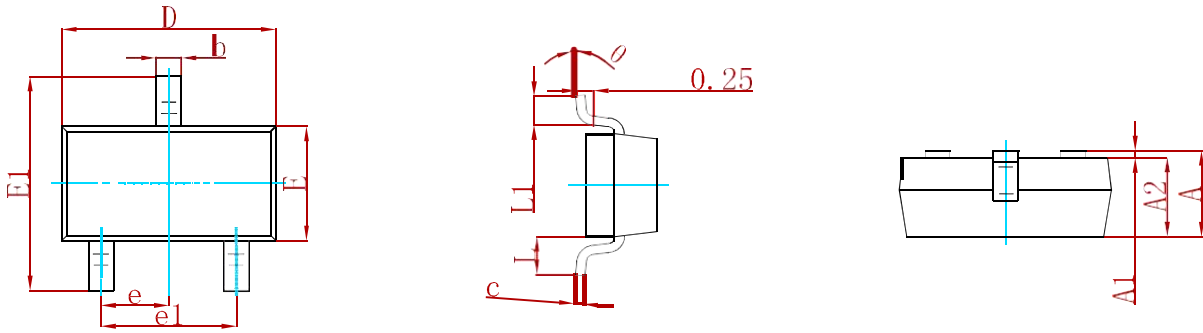

Figure 5. Steady State Power Derating Curve

PACKAGE MECHANICAL DATA



Symbol	Dimensions In Millimeters		Dimensions In Inches	
	Min	Max	Min	Max
A	0.900	1.150	0.035	0.045
A1	0.000	0.100	0.000	0.004
A2	0.900	1.050	0.035	0.041
b	0.300	0.500	0.012	0.020
c	0.080	0.150	0.003	0.006
D	2.800	3.000	0.110	0.118
E	1.200	1.400	0.047	0.055
E1	2.250	2.550	0.089	0.100
e	0.950 TYP		0.037 TYP	
e1	1.800	2.000	0.071	0.079
L	0.550 REF		0.022 REF	
L1	0.300	0.500	0.012	0.020
θ	0°	8°	0°	8°

Suggested Pad Layout

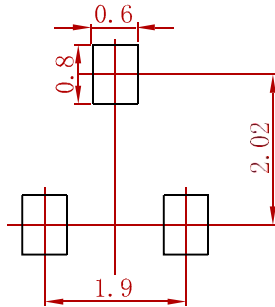

- Note:
1. Controlling dimension: in millimeters.
 2. General tolerance: ± 0.05mm.
 3. The pad layout is for reference purposes only.

REEL SPECIFICATION

P/N	PKG	QTY
MMBZXXXALT1G-MS	SOT-23	3000

Attention

- Any and all MSKSEMI Semiconductor products described or contained herein do not have specifications that can handle applications that require extremely high levels of reliability, such as life-support systems, aircraft's control systems, or other applications whose failure can be reasonably expected to result in serious physical and/or material damage. Consult with your MSKSEMI Semiconductor representative nearest you before using any MSKSEMI Semiconductor products described or contained herein in such applications.
- MSKSEMI Semiconductor assumes no responsibility for equipment failures that result from using products at values that exceed, even momentarily, rated values (such as maximum ratings, operating condition ranges, or other parameters) listed in products specifications of any and all MSKSEMI Semiconductor products described or contained herein.
- Specifications of any and all MSKSEMI Semiconductor products described or contained herein stipulate the performance, characteristics, and functions of the described products in the independent state, and are not guarantees of the performance, characteristics, and functions of the described products as mounted in the customer's products or equipment. To verify symptoms and states that cannot be evaluated in an independent device, the customer should always evaluate and test devices mounted in the customer's products or equipment.
- MSKSEMI Semiconductor strives to supply high-quality high-reliability products. However, any and all semiconductor products fail with some probability. It is possible that these probabilistic failures could give rise to accidents or events that could endanger human lives, that could give rise to smoke or fire, or that could cause damage to other property. When designing equipment, adopt safety measures so that these kinds of accidents or events cannot occur. Such measures include but are not limited to protective circuits and error prevention circuits for safe design, redundant design, and structural design.
- In the event that any or all MSKSEMI Semiconductor products (including technical data, services) described or contained herein are controlled under any of applicable local export control laws and regulations, such products must not be exported without obtaining the export license from the authorities concerned in accordance with the above law.
- No part of this publication may be reproduced or transmitted in any form or by any means, electronic or mechanical, including photocopying and recording, or any information storage or retrieval system, or otherwise, without the prior written permission of MSKSEMI Semiconductor.
- Information (including circuit diagrams and circuit parameters) herein is for example only ; it is not guaranteed for volume production. MSKSEMI Semiconductor believes information herein is accurate and reliable, but no guarantees are made or implied regarding its use or any infringements of intellectual property rights or other rights of third parties.
- Any and all information described or contained herein are subject to change without notice due to product/technology improvement, etc. When designing equipment, refer to the "Delivery Specification" for the MSKSEMI Semiconductor product that you intend to use.