

DESCRIPTION:

TVS diodes can be used in a wide range of applications which like consumer electronic products, automotive industries, munitions, telecommunications, aerospace industries, and intelligent control systems.

FEATURES:

- ✧ Glass passivated or planar junction.
- ✧ Excellent clamping capability.
- ✧ Repetition rate (duty cycle): 0.01%.
- ✧ Typical I_R less than $1\mu A$ above 10V.
- ✧ Low profile package and low inductance.
- ✧ 600W Peak Pulse power capability at $10 \times 1000\mu s$ waveform.
- ✧ Fast response time: typically less than 1.0ps from 0V to V_{BR} min.
- ✧ High temperature soldering: $260^\circ C/10s$ at terminals.
- ✧ Plastic package has Underwriters Laboratory Flammability 94V-0.
- ✧ For surface mounted applications in order to optimize board space.

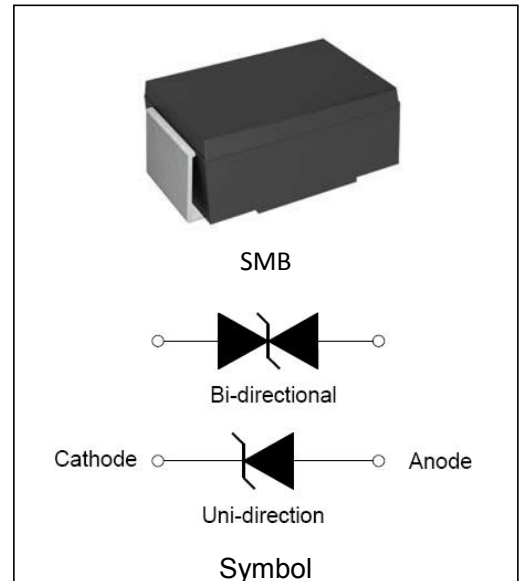

ABSOLUTE MAXIMUM RATINGS ($T_A=25^\circ C$, RH=45%-75%, unless otherwise noted)

Parameter	Symbol	Value	Unit
Storage temperature range	T_{stg}	-55 to +150	$^\circ C$
Operating junction temperature range	T_j	-55 to +150	$^\circ C$
Steady state power dissipation at $T_L=75^\circ C$	$P_{M(AV)}$	5.0	W
Peak pulse power dissipation on 10/1000 μs waveform	P_{PP}	600	W
Maximum Instantaneous Forward Voltage at 50A for Unidirectional	V_F	5.0	V

MARKING

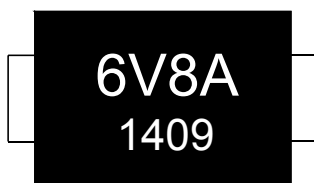

6V8A : Device Marking Code
 1409: In ninth week, 2014

ELECTRICAL CHARACTERISTICS (T_A=25°C)

Part Number		Marking		V _R	I _R @ V _R	V _{BR} @I _T		I _T	V _C @ I _{PP}	I _{PP} ®
Uni-polar	Bi-polar	Uni	Bi	(V)	μA	min(V)	max(V)	mA	V	A
P6SMB6.8A	P6SMB6.8CA	6V8A	6V8C	5.8	1000	6.45	7.14	10	10.5	58.1
P6SMB7.5A	P6SMB7.5CA	7V5A	7V5C	6.4	500	7.13	7.88	10	11.3	54.0
P6SMB8.2A	P6SMB8.2CA	8V2A	8V2C	7.02	200	7.79	8.61	10	12.1	50.4
P6SMB9.1A	P6SMB9.1CA	9V1A	9V1C	7.78	50	8.65	9.55	1	13.4	45.5
P6SMB10A	P6SMB10CA	10A	10C	8.55	10	9.50	10.50	1	14.5	42.1
P6SMB11A	P6SMB11CA	11A	11C	9.4	5	10.50	11.60	1	15.6	39.1
P6SMB12A	P6SMB12CA	12A	12C	10.2	5	11.40	12.60	1	16.7	36.5
P6SMB13A	P6SMB13CA	13A	13C	11.1	5	12.40	13.70	1	18.2	33.5
P6SMB15A	P6SMB15CA	15A	15C	12.8	1	14.30	15.80	1	21.2	28.8
P6SMB16A	P6SMB16CA	16A	16C	13.6	1	15.20	16.80	1	22.5	27.1
P6SMB18A	P6SMB18CA	18A	18C	15.3	1	17.10	18.90	1	25.2	24.2
P6SMB20A	P6SMB20CA	20A	20C	17.1	1	19.00	21.00	1	27.7	21.7
P6SMB22A	P6SMB22CA	22A	22C	18.8	1	20.90	23.10	1	30.6	19.7
P6SMB24A	P6SMB24CA	24A	24C	20.5	1	22.80	25.20	1	33.2	18.4
P6SMB27A	P6SMB27CA	27A	27C	23.1	1	25.70	28.40	1	37.5	16.3
P6SMB30A	P6SMB30CA	30A	30C	25.6	1	28.50	31.50	1	41.4	14.7
P6SMB33A	P6SMB33CA	33A	33C	28.2	1	31.40	34.70	1	45.7	13.3
P6SMB36A	P6SMB36CA	36A	36C	30.8	1	34.20	37.80	1	49.9	12.2
P6SMB39A	P6SMB39CA	39A	39C	33.3	1	37.10	41.00	1	53.9	11.3
P6SMB43A	P6SMB43CA	43A	43C	36.8	1	40.90	45.20	1	59.3	10.3
P6SMB47A	P6SMB47CA	47A	47C	40.2	1	44.70	49.40	1	64.8	9.3
P6SMB51A	P6SMB51CA	51A	51C	43.6	1	48.50	53.60	1	70.1	8.6
P6SMB56A	P6SMB56CA	56A	56C	47.8	1	53.20	58.80	1	77.0	7.8
P6SMB62A	P6SMB62CA	62A	62C	53.0	1	58.90	65.10	1	85.0	7.1
P6SMB68A	P6SMB68CA	68A	68C	58.1	1	64.60	71.40	1	92.0	6.6
P6SMB75A	P6SMB75CA	75A	75C	64.1	1	71.30	78.80	1	103.0	5.9
P6SMB82A	P6SMB82CA	82A	82C	70.1	1	77.90	86.10	1	113.0	5.4
P6SMB91A	P6SMB91CA	91A	91C	77.8	1	86.50	95.50	1	125.0	4.8
P6SMB100A	P6SMB100CA	100A	100C	85.5	1	95.00	105.0	1	137.0	4.4

ELECTRICAL CHARACTERISTICS (T_A=25°C, continued)

Part Number		Marking		V _R	I _R @ V _R	V _{BR} @I _T		I _T	V _C @ I _{PP}	I _{PP} [Ⓞ]
Uni-Polar	Bi-Polar	Uni	Bi	V	μA	min(V)	max(V)	mA	V	A
P6SMB110A	P6SMB110CA	110A	110C	94.0	1	105.0	116.0	1	152.0	4.0
P6SMB120A	P6SMB120CA	120A	120C	102	1	114.0	126.0	1	165.0	3.7
P6SMB130A	P6SMB130CA	130A	130C	111	1	124.0	137.0	1	179.0	3.4
P6SMB150A	P6SMB150CA	150A	150C	128	1	143.0	158.0	1	207.0	2.9
P6SMB160A	P6SMB160CA	160A	160C	136	1	152.0	168.0	1	219.0	2.8
P6SMB170A	P6SMB170CA	170A	170C	145	1	162.0	179.0	1	234.0	2.6
P6SMB180A	P6SMB180CA	180A	180C	154	1	171.0	189.0	1	246.0	2.5
P6SMB200A	P6SMB200CA	200A	200C	171	1	190.0	210.0	1	274.0	2.2
P6SMB220A	P6SMB220CA	220A	220C	185	1	209.0	231.0	1	328.0	1.9
P6SMB250A	P6SMB250CA	250A	250C	214	1	237.0	263.0	1	344.0	1.8
P6SMB300A	P6SMB300CA	300A	300C	256	1	285.0	315.0	1	414.0	1.5
P6SMB350A	P6SMB350CA	350A	350C	300	1	332.0	368.0	1	482.0	1.3
P6SMB400A	P6SMB400CA	400A	400C	342	1	380.0	420.0	1	548.0	1.1
P6SMB440A	P6SMB440CA	440A	440C	376	1	418.0	462.0	1	602.0	1.0
P6SMB480A	P6SMB480CA	480A	480C	408	1	456.0	504.0	1	658.0	0.9
P6SMB510A	P6SMB510CA	510A	510C	434	1	485.0	535.0	1	698.0	0.9
P6SMB550A	P6SMB550CA	550A	550C	460	1	513.0	567.0	1	740.0	0.8
P6SMB600A	P6SMB600CA	600A	600C	512	1	570.0	630.0	1	828.0	0.75

Ⓞ Surge waveform: 10/1000μs

V_R: Stand-off Voltage -- Maximum voltage that can be applied

V_{BR}: Breakdown Voltage

V_C: Clamping Voltage -- Peak voltage measured across the suppressor at a specified I_{pp}

I_R: Reverse Leakage Current

ORDERING INFORMATION

<p>P6SMB</p> <p>600W SMB Series</p> <p>V_{BR} Voltage</p>	<p>XX</p>	<p>C</p> <p>C: Bi-directional</p>	<p>A</p> <p>5% V_{BR} Voltage tolerance</p>
---	------------------	--	---

RATINGS AND V-I CHARACTERISTICS CURVES ($T_A=25^\circ\text{C}$, unless otherwise noted)

FIG.1: V- I curve characteristics (Uni-directional)

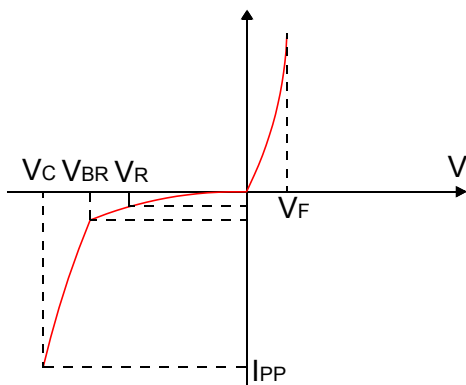

FIG.2: V- I curve characteristics (Bi-directional)

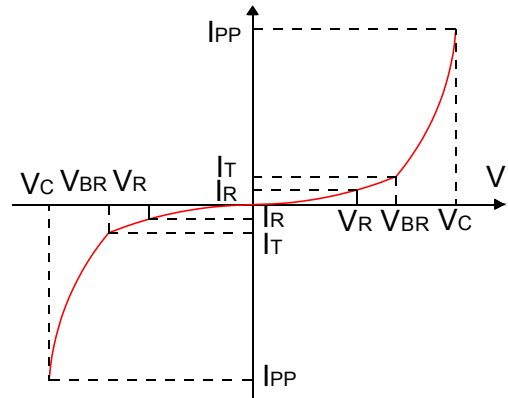

FIG.3: Pulse waveform

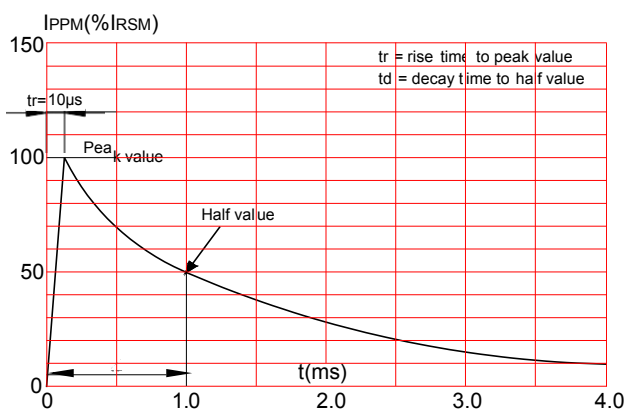
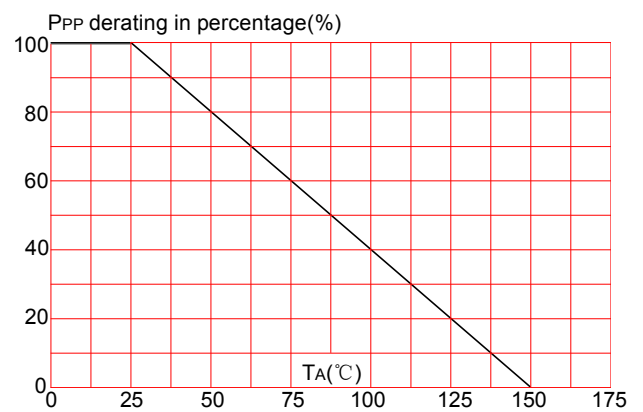
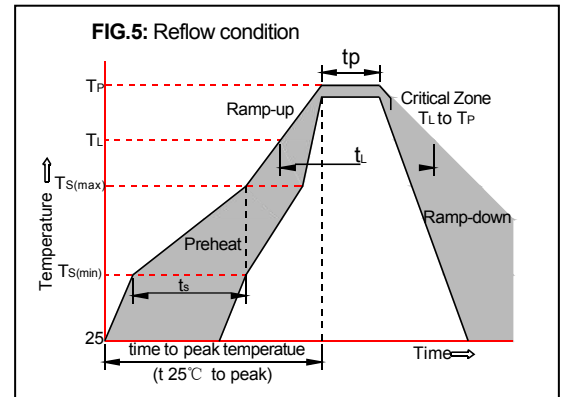
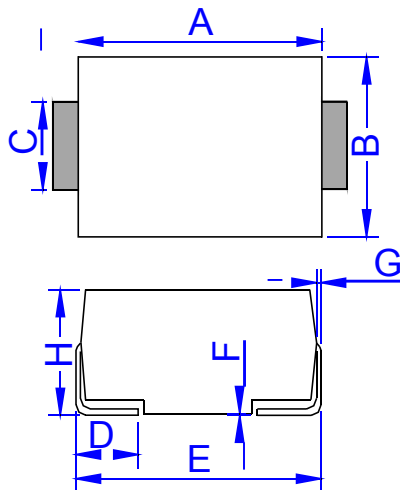

FIG.4: Pulse derating curve



SOLDERING PARAMETERS

Reflow Condition		Pb-Free assembly (see FIG.5)
Pre Heat	-Temperature Min ($T_{s(min)}$)	+150°C
	-Temperature Max($T_{s(max)}$)	+200°C
	-Time (Min to Max) (t_s)	60-180 secs.
Average ramp up rate (Liquid us Temp (T_L) to peak)		3°C/sec. Max
$T_{s(max)}$ to T_L - Ramp-up Rate		3°C/sec. Max
Reflow	-Temperature(T_L)(Liquid us)	+217°C
	-Temperature(t_L)	60-150 secs.
Peak Temp (T_p)		+260(+0/-5)°C
Time within 5°C of actual Peak Temp (t_p)		30 secs. Max
Ramp-down Rate		6°C/sec. Max
Time 25°C to Peak Temp (T_p)		8 min. Max
Do not exceed		+260°C

PACKAGE MECHANICAL DATA

DO-214AA (SMB)

Ref.	Dimensions			
	Millimeters		Inches	
	Min.	Max.	Min.	Max.
A	4.25	4.75	0.167	0.187
B	3.30	3.94	0.130	0.155
C	1.85	2.21	0.073	0.087
D	0.76	1.52	0.030	0.060
E	5.08	5.59	0.200	0.220
F	0.051	0.203	0.002	0.008
G	0.15	0.31	0.006	0.012
H	2.11	2.44	0.083	0.096
J	6.80		0.270	
K		2.60		0.100
L	2.40		0.090	

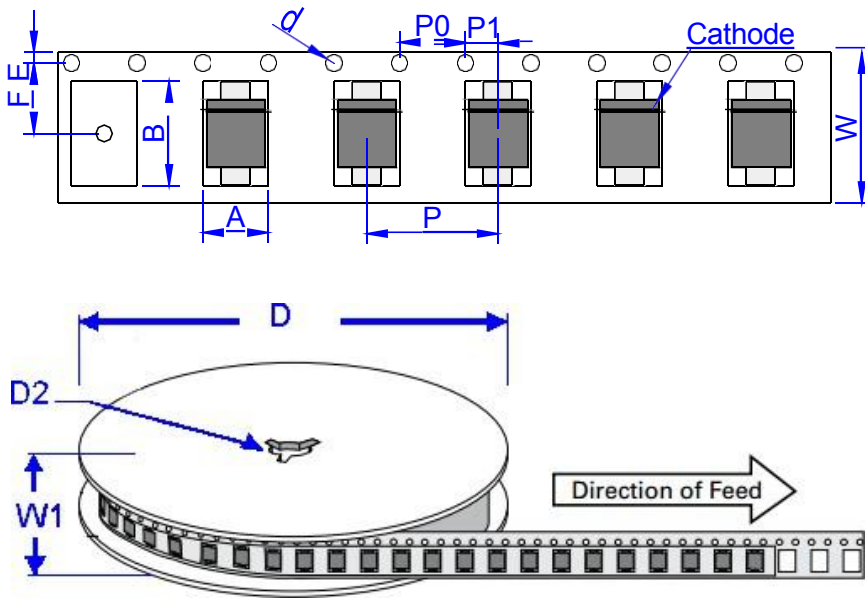
TAPE AND REEL SPECIFICATION-SMB

Ref.	Dimensions	
	Millimeters	Inches
A	3.76 ± 0.2	0.144 ± 0.012
B	5.69 ± 0.2	0.244 ± 0.012
d	1.5 ± 0.25	0.059 ± 0.004
D	330.0	13.0
D2	13 ± 1	0.512 ± 0.039
E	1.75 ± 0.2	0.059 ± 0.008
F	5.5 ± 0.1	0.222 ± 0.008
P	8.0 ± 0.2	0.315 ± 0.008
P0	4.0 ± 0.2	0.157 ± 0.008
P1	2.0 ± 0.2	0.079 ± 0.008
W	12.0 ± 0.3	0.472 ± 0.008
W1	16.8 ± 2.0	0.661 ± 0.079

OUTLINE	REEL (PCS)	PER CARTON (PCS)	REEL DIAMETERS (mm)
TAPING	3,000	48,000	330

Website: <http://www.jksemi.com>

For additional information, please contact your local Sales Representative.

©Copyright 2021, jksemi