

600 V, 2 X 30 A ultrafast high voltage rectifier

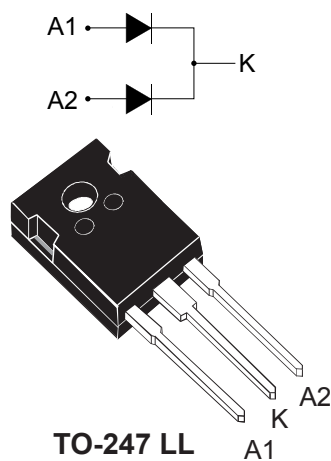

Features

- High junction temperature capability
- Ultrafast with soft recovery behavior
- Low reverse current
- Low thermal resistance
- Reduced switching and conduction losses
- **ECOPACK2** compliant component

Applications

- Solar boost diode
- Output rectification
- PFC
- UPS
- Air conditioning
- Charging station
- OBC in EV-HEV

Description

The **STTH60RQ06CWL** has been developed for applications requiring a high-voltage (HV) capability such as in secondary rectification in HV LLC full bridge topology or in high voltage boost function.

It is ideal for switching power supplies and industrial applications, as rectification function, or even freewheeling and clamping diode.

Product status link	
STTH60RQ06CWL	
Product summary	
Symbol	Value
$I_{F(AV)}$	2 X 30 A
V_{RRM}	600 V
$V_F(max.)$	1.45 V
$t_{rr}(max.)$	30 ns
$T_j(max.)$	175 °C

1 Characteristics

Table 1. Absolute ratings (limiting values at 25 °C, unless otherwise specified)

Symbol	Parameter		Value	Unit
V_{RRM}	Repetitive peak reverse voltage		600	V
$I_{F(RMS)}$	Forward rms current		50	A
$I_{F(AV)}$	Average forward current	Per diode	30	A
		Per device		
		$T_C = 103\text{ °C}$, $\delta = 0.5$ square		
I_{FSM}	Surge non repetitive forward current	$t_p = 10\text{ ms}$ sinusoidal	200	A
T_{stg}	Storage temperature range		-65 to +175	°C
T_j	Maximum operating junction temperature		175	°C

Table 2. Thermal resistance parameters

Symbol	Parameter		Max.	Unit
$R_{th(j-c)}$	Junction to case	Per diode	0.9	°C/W
		Per device	0.45	

For more information, please refer to the following application note:

- AN5088: Rectifiers thermal management, handling and mounting recommendations

Table 3. Static electrical characteristics

Symbol	Parameter	Test conditions		Min.	Typ.	Max.	Unit
$I_R^{(1)}$	Reverse leakage current	$T_j = 25\text{ °C}$	$V_R = 600\text{ V}$	-		40	μA
		$T_j = 150\text{ °C}$		-	80	800	
$V_F^{(2)}$	Forward voltage drop	$T_j = 25\text{ °C}$	$I_F = 15\text{ A}$	-		2.45	V
		$T_j = 150\text{ °C}$		-	1.15	1.45	
		$T_j = 25\text{ °C}$	$I_F = 30\text{ A}$	-		2.95	
		$T_j = 150\text{ °C}$		-	1.45	1.85	

1. Pulse test: $t_p = 5\text{ ms}$, $\delta < 2\%$

2. Pulse test: $t_p = 380\text{ }\mu\text{s}$, $\delta < 2\%$

To evaluate the conduction losses, use the following equation:

$$P = 1.05 \times I_{F(AV)} + 0.026 \times I_{F(RMS)}^2$$

For more information, please refer to the following application notes related to the power losses:

- AN604: Calculation of conduction losses in a power rectifier
- AN4021: Calculation of reverse losses on a power diode
- AN5028: Calculation of turn-off power losses generated by an ultrafast diode

Table 4. Dynamic electrical characteristics

Symbol	Parameter	Test conditions		Min.	Typ.	Max.	Unit
t_{rr}	Reverse recovery time	$T_j = 25\text{ °C}$	$I_F = 0.5\text{ A}, I_{rr} = 0.25\text{ A}, I_R = 1\text{ A}$	-		30	ns
			$I_F = 1\text{ A}, V_R = 30\text{ V}, dI_F/dt = -50\text{ A}/\mu\text{s}$	-	40	55	
I_{RM}	Reverse recovery current	$T_j = 125\text{ °C}$	$I_F = 30\text{ A}, V_R = 400\text{ V}, dI_F/dt = -200\text{ A}/\mu\text{s}$	-	8	11	A
Q_{rr}	Reverse recovery charge			-	485		nC
t_{rr}	Reverse recovery time			-	95		ns

1.1 Characteristics (curves)

Figure 1. Average forward power dissipation versus average forward current (square waveform)

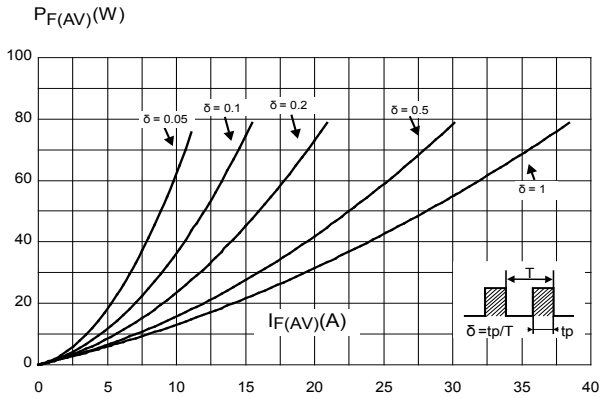

Figure 2. Average forward power dissipation versus average forward current (sinusoidal waveform)

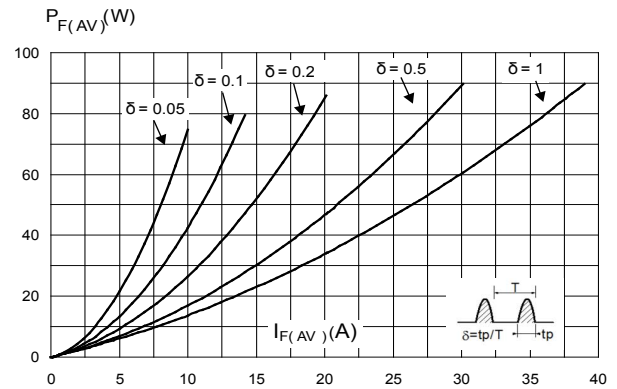

Figure 3. Forward voltage drop versus forward current (typical values)

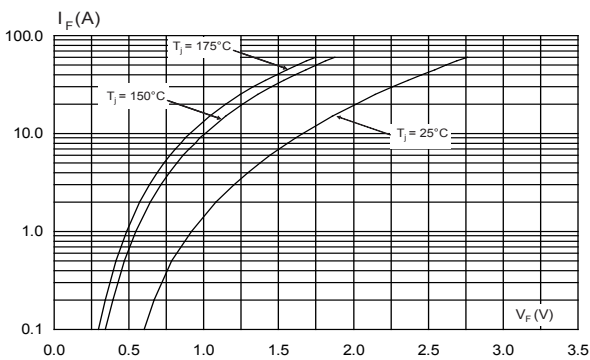

Figure 4. Forward voltage drop versus forward current (maximum values)

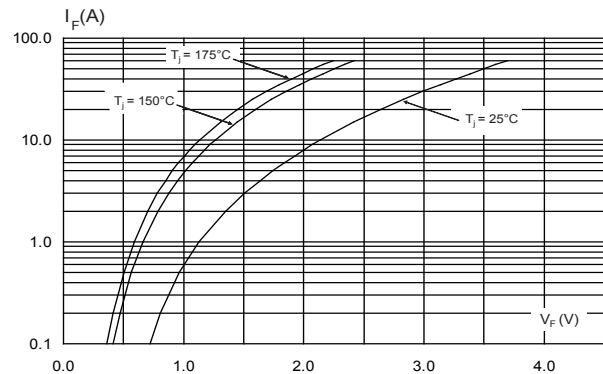

Figure 5. Relative variation of thermal impedance junction to case versus pulse duration

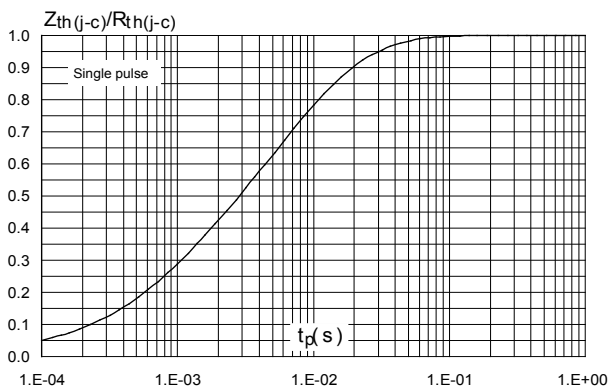

Figure 6. Peak reverse recovery current versus di_F/dt (typical values)

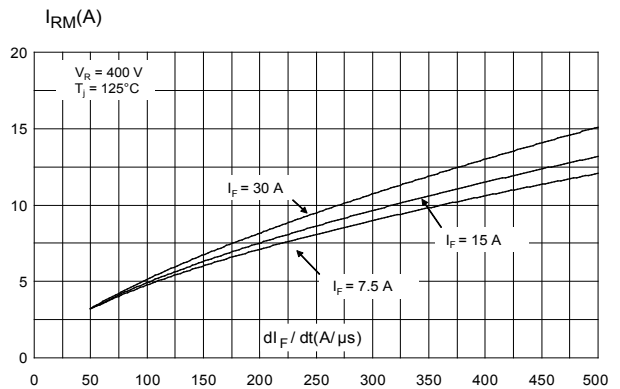

Figure 7. Reverse recovery time versus di_F/dt (typical values)

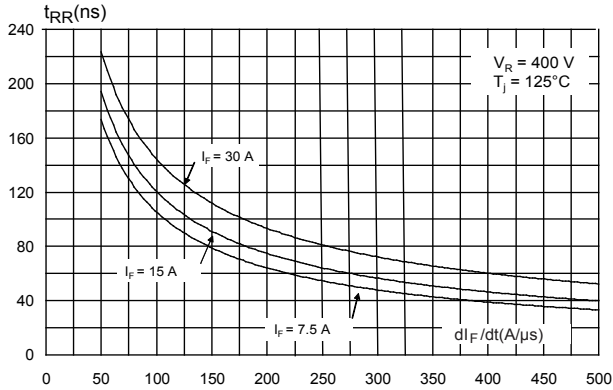

Figure 8. Reverse recovery charges versus di_F/dt (typical values)

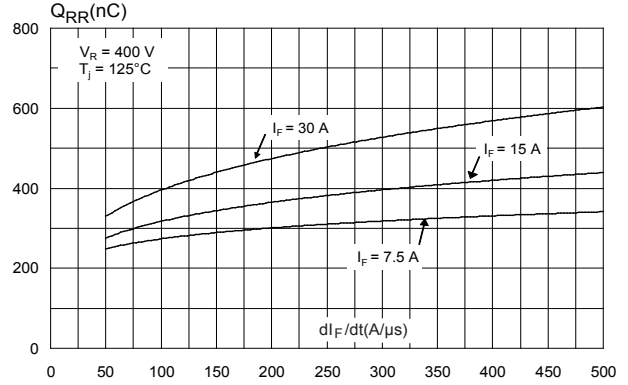

Figure 9. Reverse recovery softness factor versus di_F/dt (typical values)

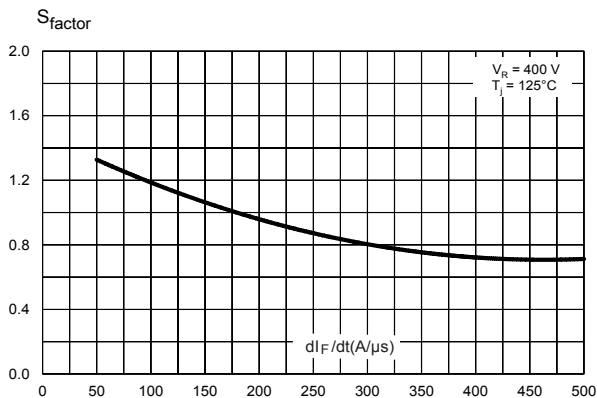

Figure 10. Relative variations of dynamic parameters versus junction temperature

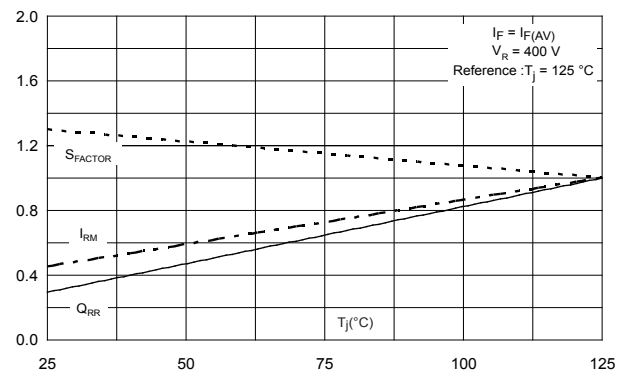

Figure 11. Junction capacitance versus reverse voltage applied (typical values)

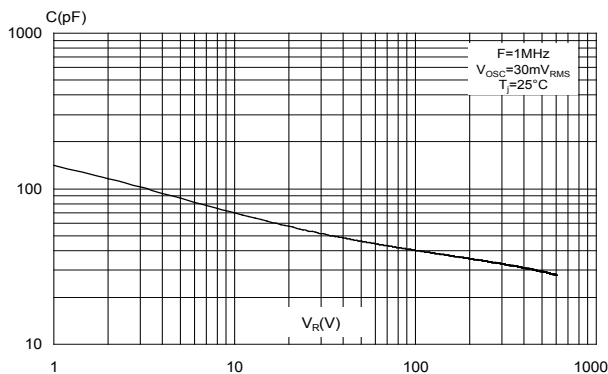

Figure 12. Relative variation of non-repetitive peak surge forward current versus pulse duration (sinusoidal waveform)

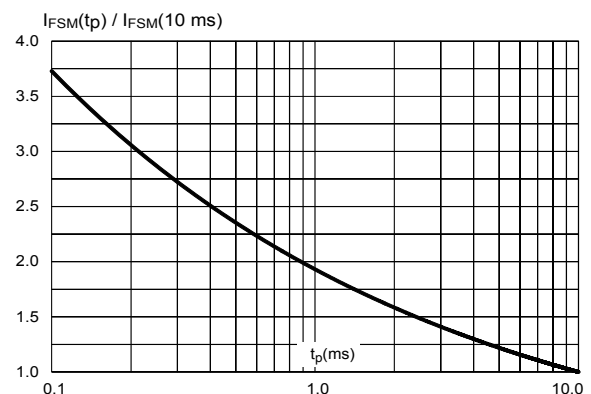
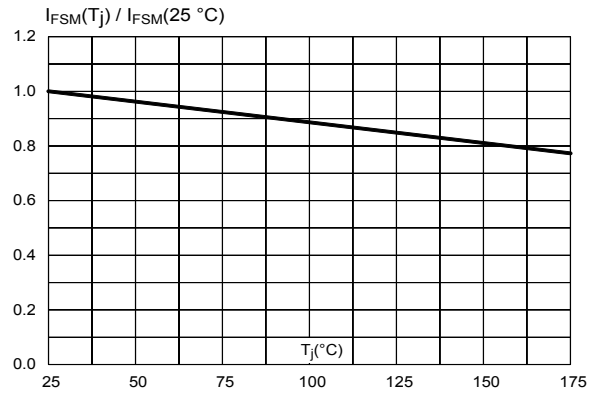

Figure 13. Relative variation of non-repetitive peak surge forward current versus initial junction temperature (sinusoidal waveform)



2 Package information

In order to meet environmental requirements, ST offers these devices in different grades of **ECOPACK** packages, depending on their level of environmental compliance. ECOPACK specifications, grade definitions and product status are available at: www.st.com. ECOPACK is an ST trademark.

2.1 TO-247 LL package information

- Epoxy meets UL94, V0
- Cooling method: by conduction (C)
- Recommended torque value: 0.8 N·m
- Maximum torque value: 1.0 N·m

Figure 14. TO-247 long leads package outline

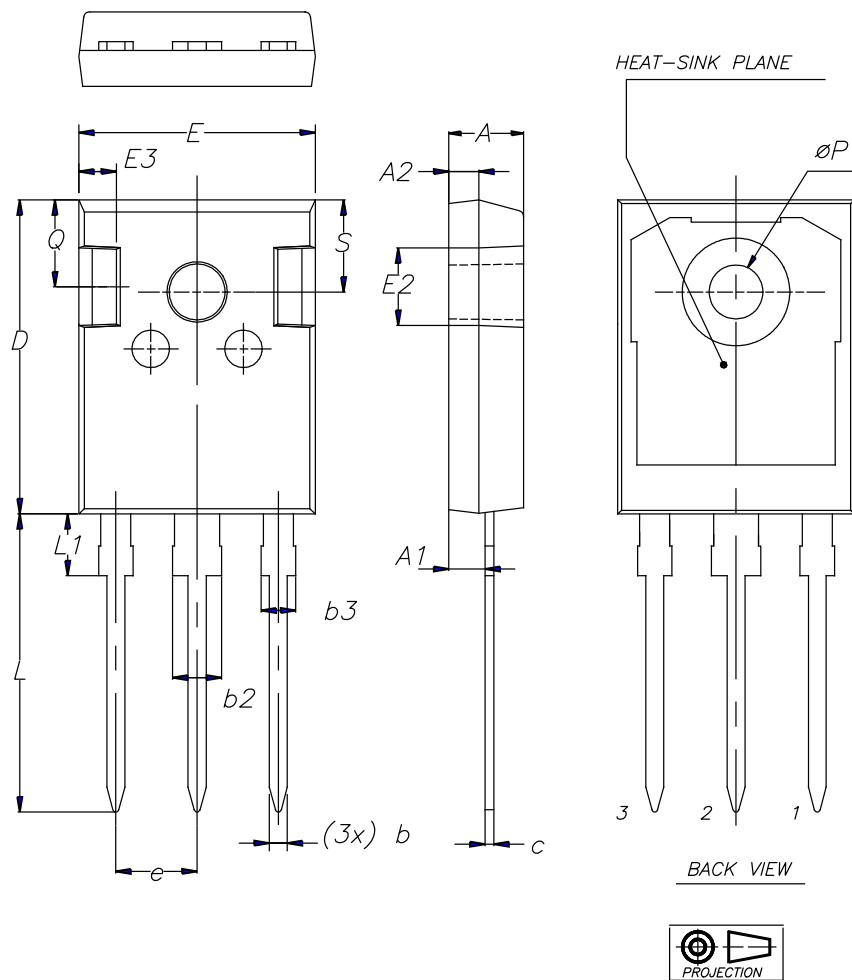

Table 5. TO-247 long leads package mechanical data

Dim.	mm.			Inches		
	Min.	Typ.	Max.	Min.	Typ.	Max.
A	4.90	-	5.15	0.192	-	0.203
A1	2.25	-	2.55	0.088	-	0.101
A2	1.85	-	2.10	0.072	-	0.083
B	1.07	-	1.32	0.042	-	0.052
B2	2.87	-	3.38	0.112	-	0.134
B3	1.90	-	2.38	0.074	-	0.094
C	0.55	-	0.67	0.021	-	0.027
D	20.82	-	21.10	0.819	-	0.831
E	15.70	-	16.02	0.618	-	0.631
E2	4.90	-	5.10	0.192	-	0.201
E3	2.40	-	2.60	0.094	-	0.103
e	5.34	-	5.54	0.210	-	0.219
L	19.80	-	20.30	0.779	-	0.800
L1	4.16	-	4.47	0.163	-	0.176
P	3.50	-	3.70	0.137	-	0.146
Q	5.49	-	6.00	0.216	-	0.237
S	6.04	-	6.29	0.237	-	0.248

3 Ordering information

Table 6. Ordering information

Order code	Marking	Package	Weight	Base qty.	Delivery mode
STTH60RQ06CWL	STTH60RQ06CWL	TO-247 LL	6.1 g	30	Tube

Revision history

Table 7. Document revision history

Date	Version	Changes
02-Mar-2020	1	Initial release.
30-Mar-2020	2	Updated Figure 1 and Figure 2 .

IMPORTANT NOTICE – PLEASE READ CAREFULLY

STMicroelectronics NV and its subsidiaries (“ST”) reserve the right to make changes, corrections, enhancements, modifications, and improvements to ST products and/or to this document at any time without notice. Purchasers should obtain the latest relevant information on ST products before placing orders. ST products are sold pursuant to ST’s terms and conditions of sale in place at the time of order acknowledgement.

Purchasers are solely responsible for the choice, selection, and use of ST products and ST assumes no liability for application assistance or the design of Purchasers’ products.

No license, express or implied, to any intellectual property right is granted by ST herein.

Resale of ST products with provisions different from the information set forth herein shall void any warranty granted by ST for such product.

ST and the ST logo are trademarks of ST. For additional information about ST trademarks, please refer to www.st.com/trademarks. All other product or service names are the property of their respective owners.

Information in this document supersedes and replaces information previously supplied in any prior versions of this document.

© 2020 STMicroelectronics – All rights reserved