

Zener Voltage Regulators

225 mW SOT-23 Surface Mount

This series of Zener diodes is offered in the convenient, surface mount plastic SOT-23 package. These devices are designed to provide voltage regulation with minimum space requirement. They are well suited for applications such as cellular phones, hand held portables, and high density PC boards.

Specification Features:

- 225 mW Rating on FR-4 or FR-5 Board
- Zener Voltage Range – 2.4 V to 91 V
- Small Package Size for High Density Applications
- ESD Rating of Class 3 (>8 KV) per Human Body Model
- We declare that the material of product compliance with RoHS requirements.
- S- Prefix for Automotive and Other Applications Requiring Unique Site and Control Change Requirements; AEC-Q101 Qualified and PPAP Capable.

Mechanical Characteristics:

CASE: Void-free, transfer-molded, thermosetting plastic case

FINISH: Corrosion resistant finish, easily solderable

MAXIMUM CASE TEMPERATURE FOR SOLDERING PURPOSES:

260°C for 10 Seconds

POLARITY: Cathode indicated by polarity band

FLAMMABILITY RATING:

UL94 V-0 MAXIMUM RATINGS

LMBZ5221BLT1G Series
S-LMBZ5221BLT1G Series

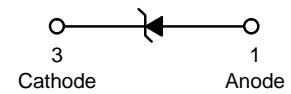
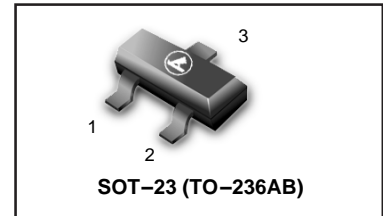

MARKING DIAGRAM

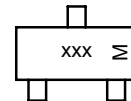

xxx = Specific Device Code
M = Date Code

Rating	Symbol	Max	Unit
Total Power Dissipation on FR-5 Board, (Note 1) @ T _A = 25°C Derated above 25°C	P _D	225 1.8	mW mW/°C
Thermal Resistance – Junction-to-Ambient	R _{θJA}	556	°C/W
Total Power Dissipation on Alumina Substrate, (Note 2) @ T _A = 25°C Derated above 25°C	P _D	300 2.4	mW mW/°C
Thermal Resistance – Junction-to-Ambient	R _{θJA}	417	°C/W
Junction and Storage Temperature Range	T _J , T _{stg}	-65 to +150	°C

1. FR-5 = 1.0 X 0.75 X 0.62 in.
2. Alumina = 0.4 X 0.3 X 0.024 in., 99.5% alumina

ORDERING INFORMATION

Device ¹	Package	Shipping
LMBZ5221BLT1G Series S-LMBZ5221BLT1G Series	SOT-23	3000/Tape&Reel
LMBZ5221BLT3G Series S-LMBZ5221BLT3G Series	SOT-23	10,000/Tape&Reel

LMBZ5221BLT1G Series , S-LMBZ5221BLT1G Series

ELECTRICAL CHARACTERISTICS

(Pinout: 1-Anode, 2-No Connection, 3-Cathode) ($T_A = 25^\circ\text{C}$ unless otherwise noted, $V_F = 0.95\text{ V Max. @ } I_F = 10\text{ mA}$)

Symbol	Parameter
V_Z	Reverse Zener Voltage @ I_{ZT}
I_{ZT}	Reverse Current
Z_{ZT}	Maximum Zener Impedance @ I_{ZT}
I_{ZK}	Reverse Current
Z_{ZK}	Maximum Zener Impedance @ I_{ZK}
I_R	Reverse Leakage Current @ V_R
V_R	Reverse Voltage
I_F	Forward Current
V_F	Forward Voltage @ I_F

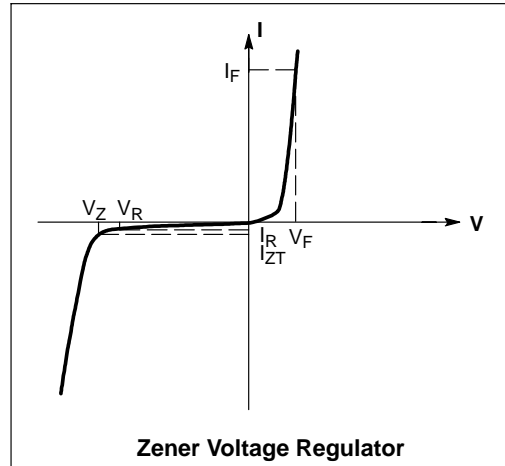

LMBZ5221BLT1G Series , S-LMBZ5221BLT1G Series

ELECTRICAL CHARACTERISTICS (Pinout: 1-Anode, 2-NC, 3-Cathode) ($V_F = 0.9\text{ V Max @ } I_F = 10\text{ mA}$ for all types.)

Device	Device Marking	Zener Voltage (Note 3)			Zener Impedance			Leakage Current		
		V_Z (Volts)			@ I_{ZT}	Z_{ZT} @ I_{ZT}	Z_{ZK} @ I_{ZK}		I_R @ V_R	
		Min	Nom	Max	mA	Ω	Ω	mA	μA	Volts
LMBZ5221BLT1G	18A	2.28	2.4	2.52	20	30	1200	0.25	100	1
LMBZ5222BLT1G	18B	2.37	2.5	2.63	20	30	1250	0.25	100	1
LMBZ5223BLT1G	18C	2.56	2.7	2.84	20	30	1300	0.25	75	1
LMBZ5224BLT1G	18D	2.66	2.8	2.94	20	30	1400	0.25	75	1
LMBZ5225BLT1G	18E	2.85	3	3.15	20	29	1600	0.25	50	1
LMBZ5226BLT1G	8A	3.13	3.3	3.47	20	28	1600	0.25	25	1
LMBZ5227BLT1G	8B	3.42	3.6	3.78	20	24	1700	0.25	15	1
LMBZ5228BLT1G	8C	3.70	3.9	4.10	20	23	1900	0.25	10	1
LMBZ5229BLT1G	8D	4.08	4.3	4.52	20	22	2000	0.25	5	1
LMBZ5230BLT1G	8E	4.46	4.7	4.94	20	19	1900	0.25	5	2
LMBZ5231BLT1G	8F	4.84	5.1	5.36	20	17	1600	0.25	5	2
LMBZ5232BLT1G	8G	5.32	5.6	5.88	20	11	1600	0.25	5	3
LMBZ5233BLT1*G	8H	5.70	6	6.30	20	7	1600	0.25	5	3.5
LMBZ5234BLT1G	8J	5.89	6.2	6.51	20	7	1000	0.25	5	4
LMBZ5235BLT1G	8K	6.46	6.8	7.14	20	5	750	0.25	3	5
LMBZ5236BLT1G	8L	7.12	7.5	7.88	20	6	500	0.25	3	6
LMBZ5237BLT1G	8M	7.79	8.2	8.61	20	8	500	0.25	3	6.5
LMBZ5238BLT1G	8N	8.26	8.7	9.14	20	8	600	0.25	3	6.5
LMBZ5239BLT1G	8P	8.64	9.1	9.56	20	10	600	0.25	3	7
LMBZ5240BLT1G	8Q	9.50	10	10.50	20	17	600	0.25	3	8
LMBZ5241BLT1G	8R	10.4	11	11.55	20	22	600	0.25	2	8.4
LMBZ5242BLT1 G	8S	11.40	12	12.60	20	30	600	0.25	1	9.1
LMBZ5243BLT1G	8T	12.35	13	13.65	9.5	13	600	0.25	0.5	9.9
LMBZ5244BLT1G	8U	13.30	14	14.70	9	15	600	0.25	0.1	10
LMBZ5245BLT1G	8V	14.25	15	15.75	8.5	16	600	0.25	0.1	11
LMBZ5246BLT1*G	8W	15.20	16	16.80	7.8	17	600	0.25	0.1	12
LMBZ5247BLT1G	8X	16.15	17	17.85	7.4	19	600	0.25	0.1	13
LMBZ5248BLT1G	8Y	17.10	18	18.90	7	21	600	0.25	0.1	14
LMBZ5249BLT1G	8Z	18.05	19	19.95	6.6	23	600	0.25	0.1	14
LMBZ5250BLT1 G	81A	19.00	20	21.00	6.2	25	600	0.25	0.1	15
LMBZ5251BLT1G	81B	20.90	22	23.10	5.6	29	600	0.25	0.1	17
LMBZ5252BLT1G	81C	22.80	24	25.20	5.2	33	600	0.25	0.1	18
LMBZ5253BLT1G	81D	23.75	25	26.25	5	35	600	0.25	0.1	19
LMBZ5254BLT1 G	81E	25.65	27	28.35	4.6	41	600	0.25	0.1	21
LMBZ5255BLT1G	81F	26.60	28	29.40	4.5	44	600	0.25	0.1	21
LMBZ5256BLT1G	81G	28.50	30	31.50	4.2	49	600	0.25	0.1	23
LMBZ5257BLT1 G	81H	31.35	33	34.65	3.8	58	700	0.25	0.1	25
LMBZ5258BLT1G	81J	34.20	36	37.80	3.4	70	700	0.25	0.1	27
LMBZ5259BLT1G	81K	37.05	39	40.95	3.2	80	800	0.25	0.1	30
LMBZ5260BLT1G	81L	40.85	43	45.15	3	93	900	0.25	0.1	33
LMBZ5261BLT1G	81M	44.65	47	49.35	2.7	105	1000	0.25	0.1	36
LMBZ5262BLT1G	81N	48.45	51	53.55	2.5	125	1100	0.25	0.1	39
LMBZ5263BLT1G	81P	53.20	56	58.80	2.2	150	1300	0.25	0.1	43
LMBZ5264BLT1G	81Q	57.00	60	63.00	2.1	170	1400	0.25	0.1	46
LMBZ5265BLT1G	81R	58.90	62	65.10	2	185	1400	0.25	0.1	47
LMBZ5266BLT1G	81S	64.60	68	71.40	1.8	230	1600	0.25	0.1	52
LMBZ5267BLT1G	81T	71.25	75	78.75	1.7	270	1700	0.25	0.1	56
LMBZ5268BLT1G*	81U	77.90	82	86.10	1.5	330	2000	0.25	0.1	62
LMBZ5269BLT1G*	81V	82.65	87	91.35	1.4	370	2200	0.25	0.1	68
LMBZ5270BLT1G*	81W	86.45	91	95.55	1.4	400	2300	0.25	0.1	69

3. Zener voltage is measured with a pulse test current I_Z at an ambient temperature of 25°C

*Not production

LMBZ5221BLT1G Series , S-LMBZ5221BLT1G Series

TYPICAL CHARACTERISTICS

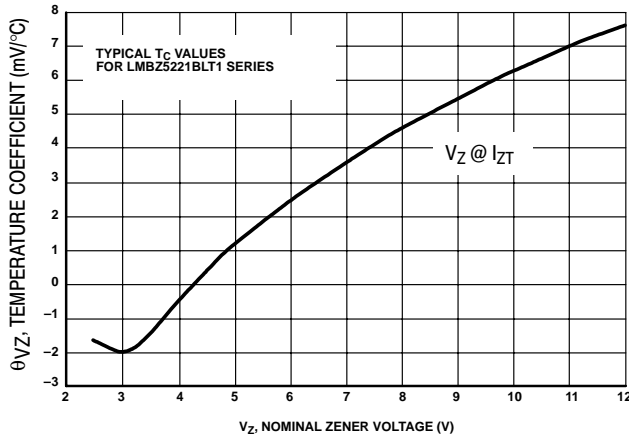

Figure 1. Temperature Coefficients (Temperature Range -55°C to +150°C)

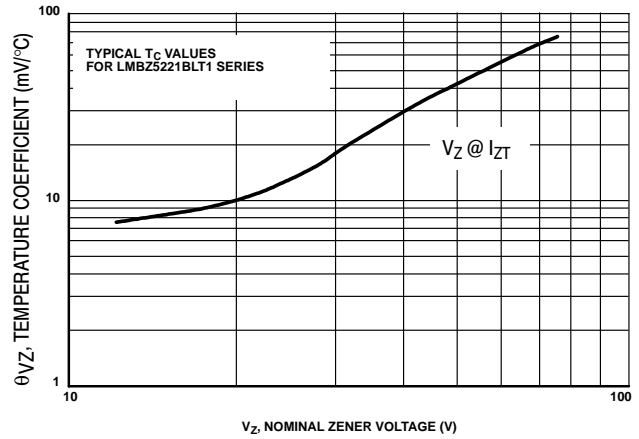

Figure 2. Temperature Coefficients (Temperature Range -55°C to +150°C)

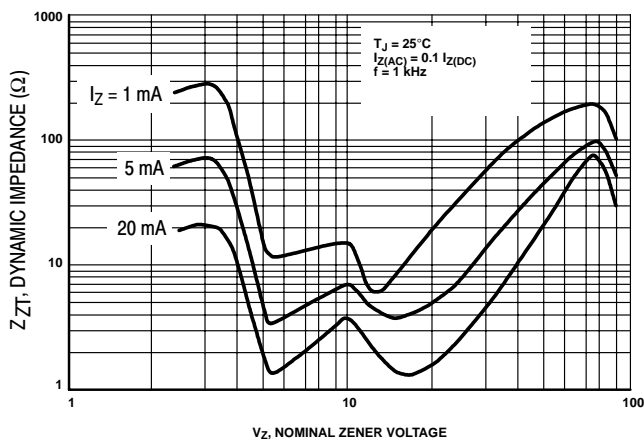

Figure 3. Effect of Zener Voltage on Zener Impedance

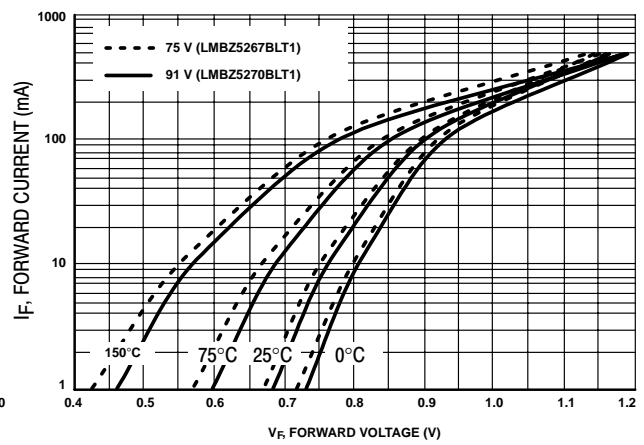

Figure 4. Typical Forward Voltage

LMBZ5221BLT1G Series , S-LMBZ5221BLT1G Series

TYPICAL CHARACTERISTICS

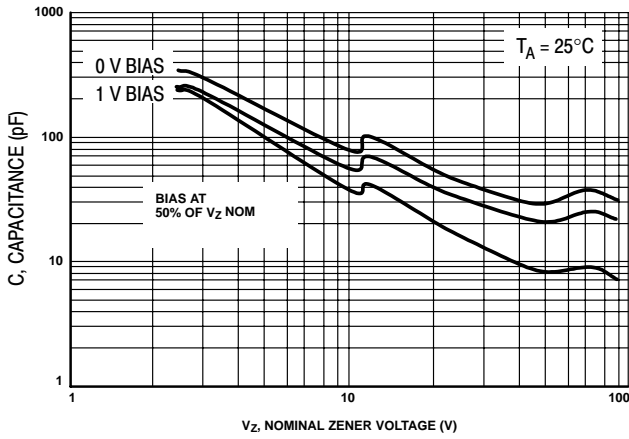

Figure 5. Typical Capacitance

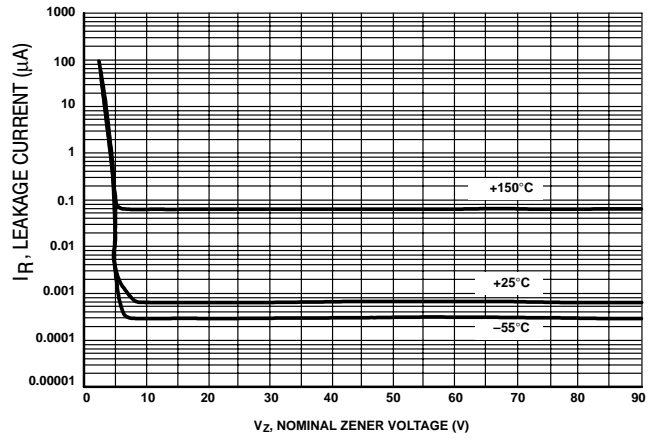

Figure 6. Typical Leakage Current

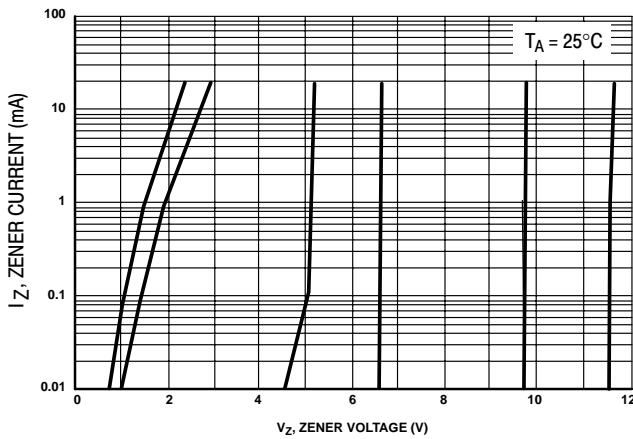

Figure 7. Zener Voltage versus Zener Current (V_Z Up to 12 V)

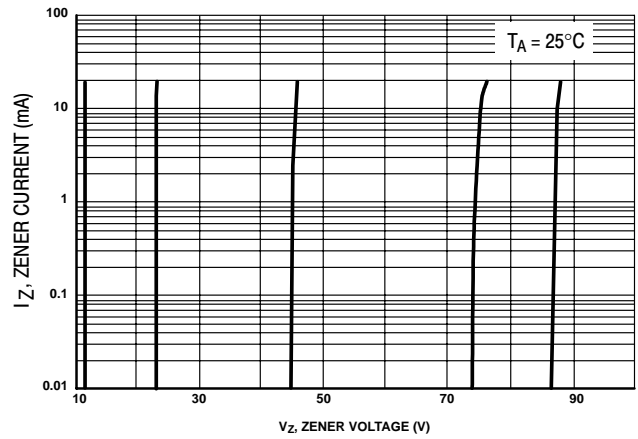

Figure 8. Zener Voltage versus Zener Current (12 V to 91 V)

LMBZ5221BLT1G Series , S-LMBZ5221BLT1G Series

SOT-23

NOTES:

1. DIMENSIONING AND TOLERANCING PER ANSI Y14.5M,1982
2. CONTROLLING DIMENSION: INCH.

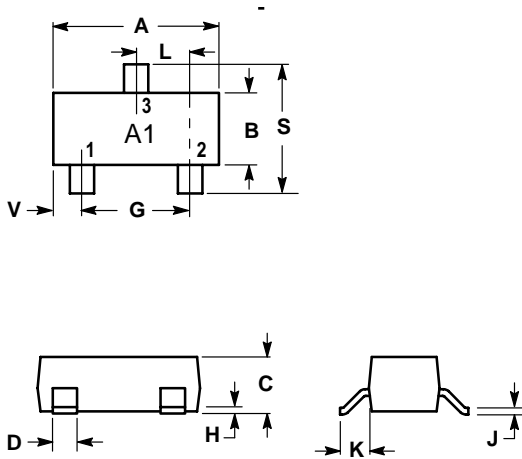

DIM	INCHES		MILLIMETERS	
	MIN	MAX	MIN	MAX
A	0.1102	0.1197	2.80	3.04
B	0.0472	0.0551	1.20	1.40
C	0.0350	0.0440	0.89	1.11
D	0.0150	0.0200	0.37	0.50
G	0.0701	0.0807	1.78	2.04
H	0.0005	0.0040	0.013	0.100
J	0.0034	0.0070	0.085	0.177
K	0.0140	0.0285	0.35	0.69
L	0.0350	0.0401	0.89	1.02
S	0.0830	0.1039	2.10	2.64
V	0.0177	0.0236	0.45	0.60

