

# CRYSTAL OSCILLATOR

## YSO110TR *Wide Voltage*

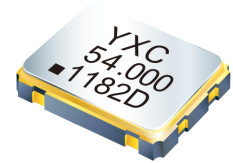

### Applications

- Consumer Electronics
- Industrial Control
- IOT

### Features

- Frequency range:1MHz-54MHz
- Ultra Small SMD seam sealed crystal oscillator units.

- Package Size: 1.6\*1.2 , 2.0\*1.6  
2.5\*2.0 , 3.2\*2.5 , 5.0\*3.2 , 7.0\*5.0mm

## Specifications

Frequency Range	1MHz to 54MHz, or specify
Supply Voltage	1.8V~3.3V
Output Type	CMOS
Frequency Tolerance(at 25°C)	±10ppm, ±20ppm, or specify
Output Load	15pF
Operating Temperature Range	-40~+85°C, -40~+125°C, or specify
Storage Temperature Range	-55~+125°C
Frequency Versus Temperature Characteristics	± 20ppm, ± 30ppm, ± 50ppm, or specify
Voltage Vol ( Max. ) / Vol ( Min. )	VOH = 90%Vdd/VOL = 10%Vdd
Duty Cycle	45~55%
Start-up Time	3ms Max.
Rise Time/Fall Time	4nS Max
Supply Current	See Below
Frequency Aging (at 25°C)	±3 ppm / year Max.

## Current Consumption

Power Dissipation Vcc=1.8~3.3V 15pF only				
Supply Voltage (V)	1.000~40.000MHZ		41.000~54.000MHZ	
	7050/5032/3225	2520/2016/1612	7050/5032/3225/2520	2016/1612
1.8V	4mA max	4mA max	9mA max	10mA max
2.5V	4.5mA max		10mA max	
3.3V	5mA max		12mA max	

## Pin Dimension

Pin	#1	#2	#3	#4
FUNCTION	Tri-state	GND	OUTPUT	VDD

## Pin Assignments

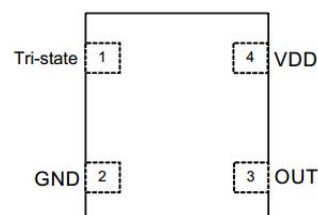

# CRYSTAL OSCILLATOR

## YSO110TR *Wide Voltage*

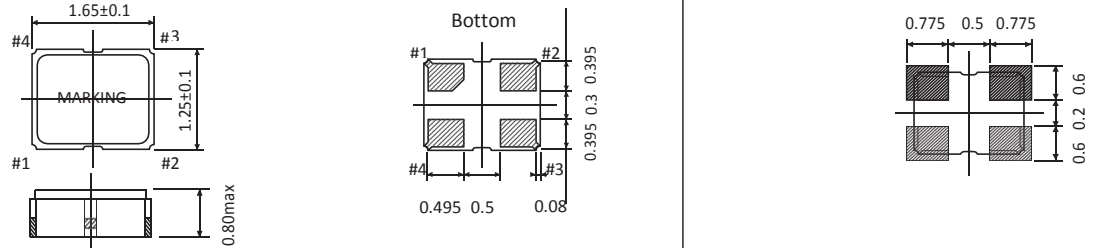
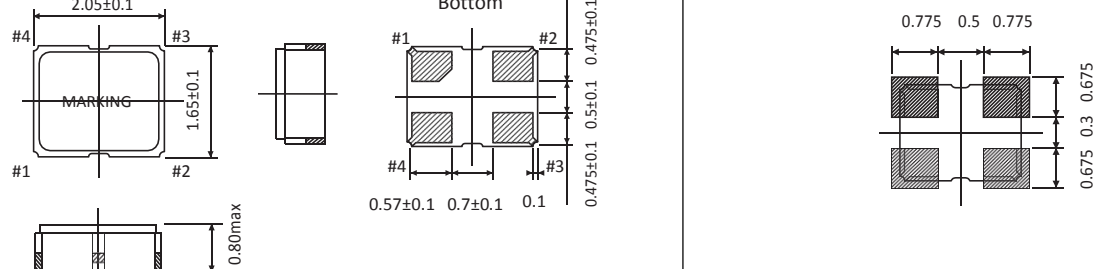
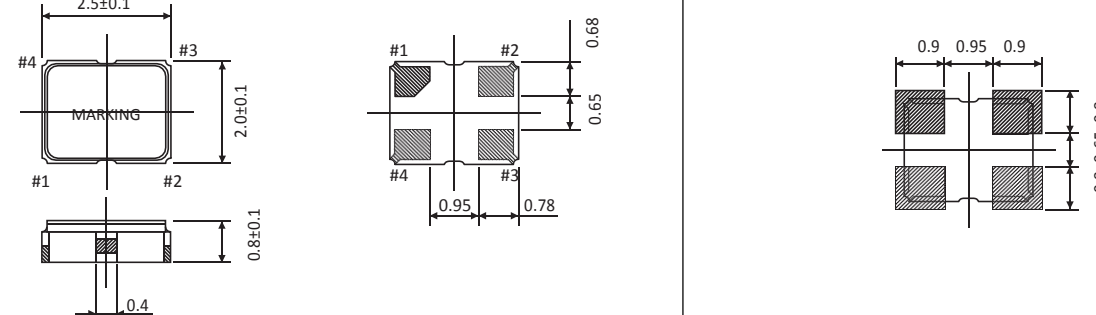
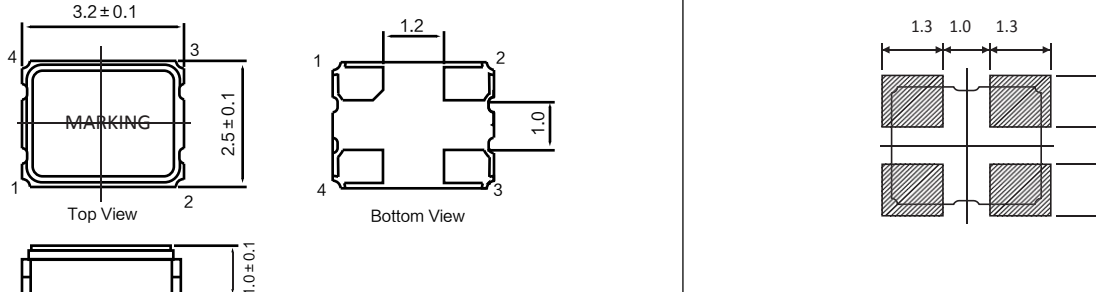

### Dimensions and Patterns [unit:mm]

Package Size – Dimensions (Unit: mm)	Recommended Land Pattern (Unit: mm)
<p>1.6*1.2mm</p> 	
<p>2.0*1.6mm</p> 	
<p>2.5*2.0mm</p> 	
<p>3.2*2.5mm</p> 	

# CRYSTAL OSCILLATOR

## YSO110TR *Wide Voltage*



<p>5.0*3.2mm</p>	
<p>7.0*5.0mm</p>	
<p><b>Notes:</b> 1.A capacitor of value 0.01uf~0.1uf or higher between Vdd and GND is required.</p>	

### Reflow Soldering Profile

Pre Heating Temperature

Tp1 ~ Tp2 = + 170 °C

Heating Temperature

TMI = + 220 °C

Peak Temperature

TMax. = + 260 °C

Point of measuring

In case of Solder ability Terminal.

In case of Resistance to soldering heat Surface.

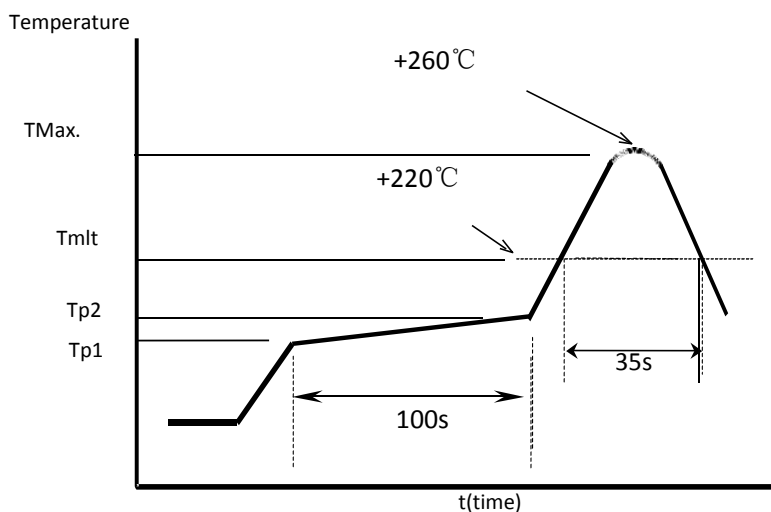

# CRYSTAL OSCILLATOR

## YSO110TR *Wide Voltage*



### Test Circuit



### Taping Specification(Unit: mm)



Size(OSC)	A	B	C	D	E	F	G	H
SMD-7050	180±2.0	16.0±0.3	7.50±0.1	5.50±0.1	8.0±0.1	2.00±0.1	61.0±1.0	16.0±1.0
SMD-5032	180±2.0	12.0±0.3	5.40±0.1	3.60±0.1	8.0±0.1	1.70±0.1	61.0±1.0	12.0±1.0
SMD-3225	180±2.0	8.0±0.3	3.40±0.1	2.70±0.1	4.0±0.1	1.50±0.1	61.0±1.0	8.0±1.0
SMD-2520	180±2.0	8.0±0.3	2.90±0.1	2.40±0.1	4.0±0.1	1.20±0.1	61.0±1.0	8.0±1.0
SMD-2016	180±2.0	8.0±0.3	2.30±0.1	1.90±0.1	4.0±0.1	0.95±0.1	61.0±1.0	8.0±1.0
SMD-1612	180±2.0	8.0±0.3	1.80±0.1	1.40±0.1	4.0±0.1	0.80±0.1	61.0±1.0	8.0±1.0