

Dual Buffer

NL27WZ16

The NL27WZ16 is a high performance dual buffer operating from a 1.65 V to 5.5 V Supply.

Features

- Designed for 1.65 V to 5.5 V V_{CC} Operation
- 2.4 ns t_{PD} at $V_{CC} = 5 V$ (Typ)
- Inputs/Outputs Overvoltage Tolerant up to 5.5 V
- I_{OFF} Supports Partial Power Down Protection
- Sink 32 mA at 4.5 V
- Available in SC-88, SC-74, TSOP-6 and UDFN6 Packages
- Chip Complexity < 100 FETs
- NLV Prefix for Automotive and Other Applications Requiring Unique Site and Control Change Requirements; AEC-Q100 Qualified and PPAP Capable
- These Devices are Pb-Free, Halogen Free/BFR Free and are RoHS Compliant

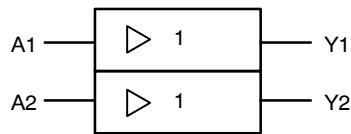
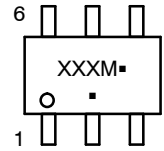

Figure 1. Logic Symbol



SC-88
DF SUFFIX
CASE 419B-02

MARKING DIAGRAMS



SC-74
CASE 318F-05

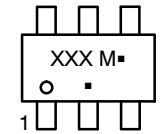

TSOP-6
CASE 318G-02

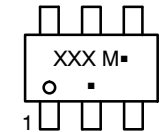

UDFN6
1.2x1.0, 0.4P
CASE 517AA

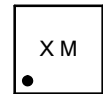

UDFN6
1.45x1.0, 0.5P
CASE 517AQ

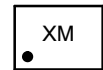

UDFN6
1x1, 0.35P
CASE 517BX

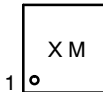

X, XXX = Specific Device Code
M = Date Code*
▪ = Pb-Free Package

(Note: Microdot may be in either location)

*Date Code orientation and/or position may vary depending upon manufacturing location.

ORDERING INFORMATION

See detailed ordering and shipping information in the package dimensions section on page 6 of this data sheet.

NL27WZ16

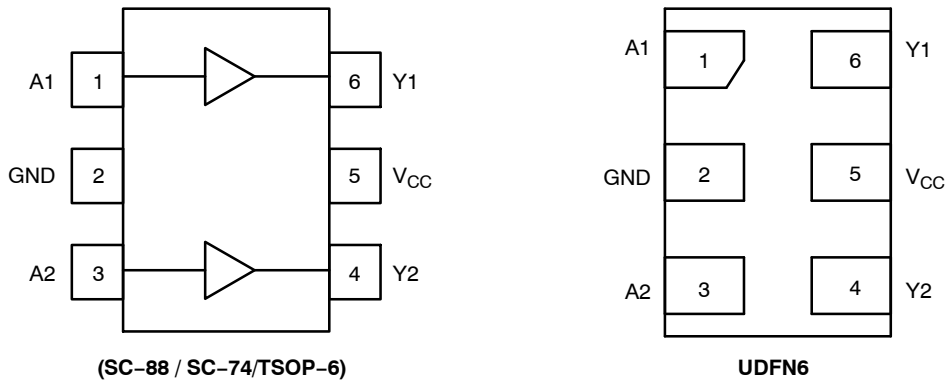

Figure 2. Pinout (Top View)

PIN ASSIGNMENT

| Pin | Function |
|-----|-----------------|
| 1 | A1 |
| 2 | GND |
| 3 | A2 |
| 4 | Y2 |
| 5 | V _{CC} |
| 6 | Y1 |

FUNCTION TABLE

| A Input | Y Output |
|---------|----------|
| L | L |
| H | H |

NL27WZ16

MAXIMUM RATINGS

| Symbol | Characteristics | Value | Units | |
|-------------------------------------|---|--|-------------------|------|
| V _{CC} | DC Supply Voltage TSOP-6, SC-88 (NLV) SC-88, SC-74, UDFN6 | -0.5 to +7.0 -0.5 to +6.5 | V | |
| V _{IN} | DC Input Voltage TSOP-6, SC-88 (NLV) SC-88, SC-74, UDFN6 | -0.5 to +7.0 -0.5 to +6.5 | V | |
| V _{OUT} | DC Output Voltage TSOP-6, SC-88 (NLV) Active-Mode (High or Low State) Tri-State Mode (Note 1) Power-Down Mode (V _{CC} = 0 V) | -0.5 to V _{CC} +0.5 -0.5 to +7.0 -0.5 to +7.0 | V | |
| | DC Output Voltage SC-88, SC-74, UDFN6 Active-Mode (High or Low State) Tri-State Mode (Note 1) Power-Down Mode (V _{CC} = 0 V) | -0.5 to V _{CC} +0.5 -0.5 to +6.5 -0.5 to +6.5 | V | |
| I _{IK} | DC Input Diode Current, V _{IN} < GND | -50 | mA | |
| I _{OK} | DC Output Diode Current, V _{OUT} < GND | -50 | mA | |
| I _{OUT} | DC Output Source/Sink Current | ±50 | mA | |
| I _{CC} or I _{GND} | DC Supply Current per Supply Pin or Ground Pin | ±100 | mA | |
| T _{STG} | Storage Temperature Range | -65 to +150 | °C | |
| T _L | Lead Temperature, 1 mm from Case for 10 secs | 260 | °C | |
| T _J | Junction Temperature under Bias | +150 | °C | |
| θ _{JA} | Thermal Resistance (Note 2) | SC-88 SC-74 UDFN6 | 377 320 154 | °C/W |
| P _D | Power Dissipation in Still Air | SC-88 SC-74 UDFN6 | 332 390 812 | mW |
| MSL | Moisture Sensitivity | Level 1 | - | |
| F _R | Flameability Rating Oxygen Index: 28 to 34 | UL 94-V-0 @ 0.125 in | - | |
| V _{ESD} | ESD Withstand Voltage (Note 3) Human Body Model Charged Device Model (NLV) Charged Device Model | 2000 1000 N/A | V | |
| I _{LATCHUP} | Latchup Performance (Note 4) (NLV) | ±100 ±500 | mA | |

Stresses exceeding those listed in the Maximum Ratings table may damage the device. If any of these limits are exceeded, device functionality should not be assumed, damage may occur and reliability may be affected.

1. Applicable to devices with outputs that may be tri-stated.
2. Measured with minimum pad spacing on an FR4 board, using 10 mm-by-1 inch, 2 ounce copper trace no air flow per JESD51-7.
3. HBM tested to ANSI/ESDA/JEDEC JS-001-2017. CDM tested to EIA/JESD22-C101-F. JEDEC recommends that ESD qualification to EIA/JESD22-A115-A (Machine Model) be discontinued per JEDEC/JEP172A.
4. Tested to EIA/JESD78 Class II.

RECOMMENDED OPERATING CONDITIONS

| Symbol | Parameter | Min | Max | Unit |
|---------------------------------|--|------------------|---------------------|------|
| V _{CC} | Positive DC Supply Voltage | 1.65 | 5.5 | V |
| V _{IN} | DC Input Voltage | 0 | 5.5 | V |
| V _{OUT} | DC Output Voltage Active-Mode (High or Low State) Tri-State Mode (Note 1) Power-Down Mode (V _{CC} = 0 V) | 0 | V _{CC} | V |
| | | 0 | 5.5 | |
| | | 0 | 5.5 | |
| T _A | Operating Temperature Range | -55 | +125 | °C |
| t _r , t _f | Input Transition Rise or Fall Rate V _{CC} = 1.65 V to 1.95 V V _{CC} = 2.3 V to 2.7 V V _{CC} = 3.0 V to 3.6 V V _{CC} = 4.5 V to 5.5 V | 0 0 0 0 | 20 20 10 5 | ns |

Functional operation above the stresses listed in the Recommended Operating Ranges is not implied. Extended exposure to stresses beyond the Recommended Operating Ranges limits may affect device reliability.

NL27WZ16

DC ELECTRICAL CHARACTERISTICS

| Symbol | Parameter | Condition | V _{CC} (V) | T _A = 25°C | | | -55°C ≤ T _A ≤ 125°C | | Units |
|------------------|--------------------------------|---|---------------------|------------------------|-----------------|------------------------|--------------------------------|------------------------|-------|
| | | | | Min | Typ | Max | Min | Max | |
| V _{IH} | High-Level Input Voltage (NLV) | | 1.65 to 1.95 | 0.75 × V _{CC} | | | 0.75 × V _{CC} | | V |
| | | | 2.3 to 5.5 | 0.70 × V _{CC} | | | 0.70 × V _{CC} | | |
| | High-Level Input Voltage | | 1.65 to 1.95 | 0.65 × V _{CC} | | | 0.65 × V _{CC} | | V |
| | | | 2.3 to 5.5 | 0.70 × V _{CC} | | | 0.70 × V _{CC} | | |
| V _{IL} | Low-Level Input Voltage (NLV) | | 1.65 to 1.95 | | | 0.25 × V _{CC} | | 0.25 × V _{CC} | V |
| | | | 2.3 to 5.5 | | | 0.30 × V _{CC} | | 0.30 × V _{CC} | |
| | Low-Level Input Voltage | | 1.65 to 1.95 | | | 0.35 × V _{CC} | | 0.35 × V _{CC} | V |
| | | | 2.3 to 5.5 | | | 0.30 × V _{CC} | | 0.30 × V _{CC} | |
| V _{OH} | High-Level Output Voltage | V _{IN} = V _{IH} or V _{IL} I _{OH} = -100 μA I _{OH} = -4 mA I _{OH} = -8 mA I _{OH} = -12 mA I _{OH} = -16 mA I _{OH} = -24 mA I _{OH} = -32 mA | 1.65 to 5.5 | V _{CC} - 0.1 | V _{CC} | - | V _{CC} - 0.1 | - | V |
| | | | 1.65 | 1.29 | 1.4 | - | 1.29 | - | |
| | | | 2.3 | 1.9 | 2.1 | - | 1.9 | - | |
| | | | 2.7 | 2.2 | 2.4 | - | 2.2 | - | |
| | | | 3.0 | 2.4 | 2.7 | - | 2.4 | - | |
| | | | 3.0 | 2.3 | 2.5 | - | 2.3 | - | |
| | | | 4.5 | 3.8 | 4.0 | - | 3.8 | - | |
| | | | 4.5 | 3.8 | 4.0 | - | 3.8 | - | |
| V _{OL} | Low-Level Output Voltage | V _{IN} = V _{IH} or V _{IL} I _{OL} = 100 μA I _{OL} = 4 mA I _{OL} = 8 mA I _{OL} = 12 mA I _{OL} = 16 mA I _{OL} = 24 mA I _{OL} = 32 mA | 1.65 to 5.5 | - | - | 0.1 | - | 0.1 | V |
| | | | 1.65 | - | 0.08 | 0.24 | - | 0.24 | |
| | | | 2.3 | - | 0.2 | 0.3 | - | 0.3 | |
| | | | 2.7 | - | 0.22 | 0.4 | - | 0.4 | |
| | | | 3.0 | - | 0.28 | 0.4 | - | 0.4 | |
| | | | 3.0 | - | 0.38 | 0.55 | - | 0.55 | |
| | | | 4.5 | - | 0.42 | 0.55 | - | 0.55 | |
| | | | 4.5 | - | 0.42 | 0.55 | - | 0.55 | |
| I _{IN} | Input Leakage Current | V _{IN} = 5.5 V or GND | 1.65 to 5.5 | - | - | ±0.1 | - | ±1.0 | μA |
| I _{OFF} | Power Off Leakage Current | V _{IN} = 5.5 V or V _{OUT} = 5.5 V | 0 | - | - | 1.0 | - | 10 | μA |
| I _{CC} | Quiescent Supply Current | V _{IN} = V _{CC} or GND | 5.5 | - | - | 1.0 | - | 10 | μA |

Product parametric performance is indicated in the Electrical Characteristics for the listed test conditions, unless otherwise noted. Product performance may not be indicated by the Electrical Characteristics if operated under different conditions.

AC ELECTRICAL CHARACTERISTICS

| Symbol | Parameter | Condition | V _{CC} (V) | T _A = 25°C | | | -40°C ≤ T _A ≤ 85°C | | -55°C ≤ T _A ≤ 125°C | | Unit |
|--|---|---|---------------------|-----------------------|-----|-----|-------------------------------|------|--------------------------------|------|------|
| | | | | Min | Typ | Max | Min | Max | Min | Max | |
| t _{PLH} , t _{PHL} | Propagation Delay, A to Y (Figures 3 and 4) | R _L = 1 MΩ, C _L = 15 pF | 1.65 to 1.95 | - | 8.0 | 9.6 | - | 10.2 | - | 10.2 | ns |
| | | | 2.3 to 2.7 | - | 3.0 | 5.2 | - | 5.8 | - | 5.8 | |
| | | 3.0 to 3.6 | - | 2.3 | 3.6 | - | 4.0 | - | 4.0 | | |
| | | 4.5 to 5.5 | - | 1.8 | 2.9 | - | 3.2 | - | 3.2 | | |
| | | R _L = 500 Ω, C _L = 50 pF | 3.0 to 3.6 | - | 3.0 | 4.6 | - | 5.1 | - | 5.1 | |
| | | | 4.5 to 5.5 | - | 2.4 | 3.8 | - | 4.2 | - | 4.2 | |

CAPACITIVE CHARACTERISTICS

| Symbol | Parameter | Condition | Typical | Unit |
|------------------|--|--|------------|------|
| C _{IN} | Input Capacitance | V _{CC} = 5.5 V, V _I = 0 V or V _{CC} | 2.5 | pF |
| C _{OUT} | Output Capacitance | V _{CC} = 5.5 V, V _I = 0 V or V _{CC} | 4.0 | pF |
| C _{PD} | Power Dissipation Capacitance (Note 5) | 10 MHz, V _{CC} = 3.3 V, V _{IN} = 0 V or V _{CC} 10 MHz, V _{CC} = 5.0 V, V _{IN} = 0 V or V _{CC} | 11 12.5 | pF |

5. C_{PD} is defined as the value of the internal equivalent capacitance which is calculated from the operating current consumption without load. Average operating current can be obtained by the equation: I_{CC(OPR)} = C_{PD} · V_{CC} · f_{in}) I_{CC}. C_{PD} is used to determine the no-load dynamic power consumption; P_D = C_{PD} · V_{CC}² · f_{in}) I_{CC} · V_{CC}.

NL27WZ16



C_L includes probe and jig capacitance
 R_T is Z_{OUT} of pulse generator (typically 50 Ω)
 $f = 1$ MHz

Figure 3. Test Circuit

| Test | Switch Position | C_L , pF | R_L , Ω | R_1 , Ω |
|---------------------|-------------------|------------------------------|------------------|------------------|
| t_{PLH} / t_{PHL} | Open | See AC Characteristics Table | | |
| t_{PLZ} / t_{PZL} | $2 \times V_{CC}$ | 50 | 500 | 500 |
| t_{PHZ} / t_{PZH} | GND | 50 | 500 | 500 |

X = Don't Care

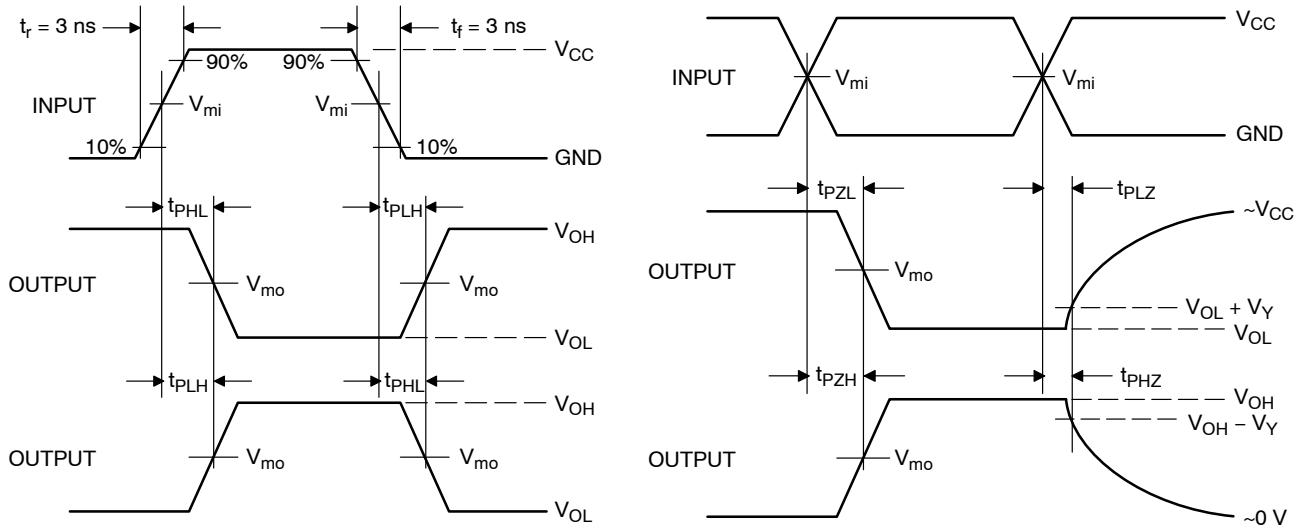

Figure 4. Switching Waveforms

| V_{CC} , V | V_{mi} , V | V_{mo} , V | | V_Y , V |
|--------------|--------------|-----------------------|---|-----------|
| | | t_{PLH} , t_{PHL} | t_{PZL} , t_{PLZ} , t_{PZH} , t_{PHZ} | |
| 1.65 to 1.95 | $V_{CC}/2$ | $V_{CC}/2$ | $V_{CC}/2$ | 0.15 |
| 2.3 to 2.7 | $V_{CC}/2$ | $V_{CC}/2$ | $V_{CC}/2$ | 0.15 |
| 3.0 to 3.6 | $V_{CC}/2$ | $V_{CC}/2$ | $V_{CC}/2$ | 0.3 |
| 4.5 to 5.5 | $V_{CC}/2$ | $V_{CC}/2$ | $V_{CC}/2$ | 0.3 |

NL27WZ16

ORDERING INFORMATION

| Device | Package | Specific Device Code | Pin1 Orientation (See below) | Shipping [†] |
|--------------------------------------|-------------------------|------------------------|---------------------------------|-----------------------|
| NL27WZ16DFT2G | SC-88 | MR | Q4 | 3000 / Tape & Reel |
| NL27WZ16DFT2G-L22348** | SC-88 | MR | Q4 | 3000 / Tape & Reel |
| NLV27WZ16DFT2G* | SC-88 | MR | Q4 | 3000 / Tape & Reel |
| NL27WZ16DBVT1G | SC-74 | MR | Q4 | 3000 / Tape & Reel |
| NL27WZ16DTT1G** | TSOP-6 | MR | Q4 | 3000 / Tape & Reel |
| NL27WZ16MU1TCG | UDFN6, 1.45 x 1.0, 0.5P | F (Rotated 90° CW) | Q4 | 3000 / Tape & Reel |
| NLV27WZ16MU1TCG* (In Development) | UDFN6, 1.45 x 1.0, 0.5P | F (Rotated 90° CW) | Q4 | 3000 / Tape & Reel |
| NL27WZ16MU3TCG | UDFN6, 1.0 x 1.0, 0.35P | T (Rotated 90° CW) | Q4 | 3000 / Tape & Reel |
| NL27WZ16MU2TCG | UDFN6, 1.2 x 1.0, 0.4P | 5 (Rotated 180° CW) | Q4 | 3000 / Tape & Reel |

[†]For information on tape and reel specifications, including part orientation and tape sizes, please refer to our Tape and Reel Packaging Specifications Brochure, BRD8011/D.

*NLV Prefix for Automotive and Other Applications Requiring Unique Site and Control Change Requirements; AEC-Q100 Qualified and PPAP Capable.

**Please refer to NLV specifications for this device.

Pin 1 Orientation in Tape and Reel

Direction of Feed

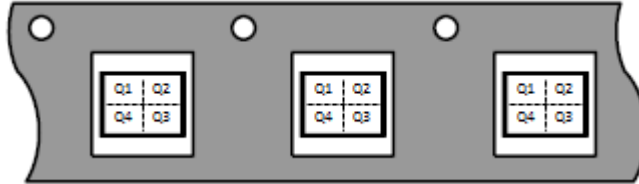

MECHANICAL CASE OUTLINE PACKAGE DIMENSIONS



SCALE 2:1

SC-74
CASE 318F
ISSUE P

DATE 07 OCT 2021

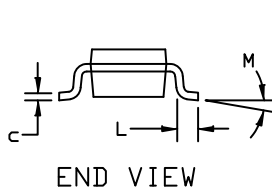
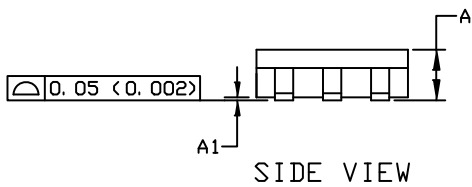
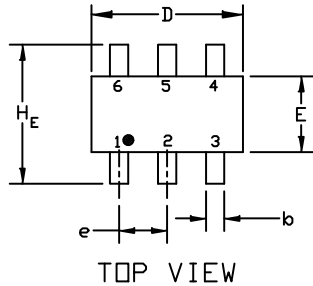

GENERIC MARKING DIAGRAM*

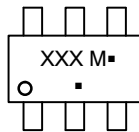

XXX = Specific Device Code
M = Date Code
▪ = Pb-Free Package

(Note: Microdot may be in either location)

*This information is generic. Please refer to device data sheet for actual part marking. Pb-Free indicator, "G" or microdot "▪", may or may not be present. Some products may not follow the Generic Marking.

NOTES:

1. DIMENSIONING AND TOLERANCING PER ASME Y14.5M, 1994
2. CONTROLLING DIMENSION: INCHES
3. MAXIMUM LEAD THICKNESS INCLUDES LEAD FINISH THICKNESS. MINIMUM LEAD THICKNESS IS THE MINIMUM THICKNESS OF THE BASE MATERIAL.

| DIM | MILLIMETERS | | | INCHES | | |
|-----|-------------|------|------|--------|-------|-------|
| | MIN. | NOM. | MAX. | MIN. | NOM. | MAX. |
| A | 0.90 | 1.00 | 1.10 | 0.035 | 0.039 | 0.043 |
| A1 | 0.01 | 0.06 | 0.10 | 0.001 | 0.002 | 0.004 |
| b | 0.25 | 0.37 | 0.50 | 0.010 | 0.015 | 0.020 |
| c | 0.10 | 0.18 | 0.26 | 0.004 | 0.007 | 0.010 |
| D | 2.90 | 3.00 | 3.10 | 0.114 | 0.118 | 0.122 |
| E | 1.30 | 1.50 | 1.70 | 0.051 | 0.059 | 0.067 |
| e | 0.85 | 0.95 | 1.05 | 0.034 | 0.037 | 0.041 |
| HE | 2.50 | 2.75 | 3.00 | 0.099 | 0.108 | 0.118 |
| L | 0.20 | 0.40 | 0.60 | 0.008 | 0.016 | 0.024 |
| M | 0* | --- | 10* | 0* | --- | 10* |

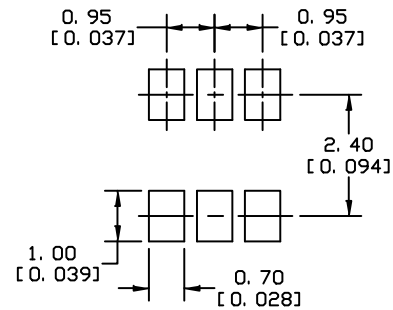

* For additional information on our Pb-Free strategy and soldering details, please download the DN Semiconductor Soldering and Mounting Techniques Reference Manual, SOLDERM/D.

SOLDERING FOOTPRINT

- | | | | | | |
|---|--|---|--|---|---|
| <p>STYLE 1: PIN 1. CATHODE 2. ANODE 3. CATHODE 4. CATHODE 5. ANODE 6. CATHODE</p> | <p>STYLE 2: PIN 1. NO CONNECTION 2. COLLECTOR 3. EMITTER 4. NO CONNECTION 5. COLLECTOR 6. BASE</p> | <p>STYLE 3: PIN 1. EMITTER 1 2. BASE 1 3. COLLECTOR 2 4. EMITTER 2 5. BASE 2 6. COLLECTOR 1</p> | <p>STYLE 4: PIN 1. COLLECTOR 2 2. EMITTER 1/EMITTER 2 3. COLLECTOR 1 4. EMITTER 3 5. BASE 1/BASE 2/COLLECTOR 3 6. BASE 3</p> | <p>STYLE 5: PIN 1. CHANNEL 1 2. ANODE 3. CHANNEL 2 4. CHANNEL 3 5. CATHODE 6. CHANNEL 4</p> | <p>STYLE 6: PIN 1. CATHODE 2. ANODE 3. CATHODE 4. CATHODE 5. CATHODE 6. CATHODE</p> |
| <p>STYLE 7: PIN 1. SOURCE 1 2. GATE 1 3. DRAIN 2 4. SOURCE 2 5. GATE 2 6. DRAIN 1</p> | <p>STYLE 8: PIN 1. EMITTER 1 2. BASE 2 3. COLLECTOR 2 4. EMITTER 2 5. BASE 1 6. COLLECTOR 1</p> | <p>STYLE 9: PIN 1. EMITTER 2 2. BASE 2 3. COLLECTOR 1 4. EMITTER 1 5. BASE 1 6. COLLECTOR 2</p> | <p>STYLE 10: PIN 1. ANODE/CATHODE 2. BASE 3. EMITTER 4. COLLECTOR 5. ANODE 6. CATHODE</p> | <p>STYLE 11: PIN 1. EMITTER 2. BASE 3. ANODE/CATHODE 4. ANODE 5. CATHODE 6. COLLECTOR</p> | |

| | | |
|-------------------------|--------------------|---|
| DOCUMENT NUMBER: | 98ASB42973B | Electronic versions are uncontrolled except when accessed directly from the Document Repository. Printed versions are uncontrolled except when stamped "CONTROLLED COPY" in red. |
| DESCRIPTION: | SC-74 | PAGE 1 OF 1 |

onsemi and ONSEMI are trademarks of Semiconductor Components Industries, LLC dba onsemi or its subsidiaries in the United States and/or other countries. onsemi reserves the right to make changes without further notice to any products herein. onsemi makes no warranty, representation or guarantee regarding the suitability of its products for any particular purpose, nor does onsemi assume any liability arising out of the application or use of any product or circuit, and specifically disclaims any and all liability, including without limitation special, consequential or incidental damages. onsemi does not convey any license under its patent rights nor the rights of others.

MECHANICAL CASE OUTLINE

PACKAGE DIMENSIONS

ON Semiconductor®



SCALE 2:1

TSOP-6 CASE 318G-02 ISSUE V

DATE 12 JUN 2012



NOTES:

1. DIMENSIONING AND TOLERANCING PER ASME Y14.5M, 1994.
2. CONTROLLING DIMENSION: MILLIMETERS.
3. MAXIMUM LEAD THICKNESS INCLUDES LEAD FINISH. MINIMUM LEAD THICKNESS IS THE MINIMUM THICKNESS OF BASE MATERIAL.
4. DIMENSIONS D AND E1 DO NOT INCLUDE MOLD FLASH, PROTRUSIONS, OR GATE BURRS. MOLD FLASH, PROTRUSIONS, OR GATE BURRS SHALL NOT EXCEED 0.15 PER SIDE. DIMENSIONS D AND E1 ARE DETERMINED AT DATUM H.
5. PIN ONE INDICATOR MUST BE LOCATED IN THE INDICATED ZONE.

| DIM | MILLIMETERS | | |
|-----|-------------|------|------|
| | MIN | NOM | MAX |
| A | 0.90 | 1.00 | 1.10 |
| A1 | 0.01 | 0.06 | 0.10 |
| b | 0.25 | 0.38 | 0.50 |
| c | 0.10 | 0.18 | 0.26 |
| D | 2.90 | 3.00 | 3.10 |
| E | 2.50 | 2.75 | 3.00 |
| E1 | 1.30 | 1.50 | 1.70 |
| e | 0.85 | 0.95 | 1.05 |
| L | 0.20 | 0.40 | 0.60 |
| L2 | 0.25 BSC | | |
| M | 0° | - | 10° |

- | | | | | | |
|--|--|---|---|---|--|
| <p>STYLE 1: PIN 1. DRAIN 2. DRAIN 3. GATE 4. SOURCE 5. DRAIN 6. DRAIN</p> | <p>STYLE 2: PIN 1. EMITTER 2 2. BASE 1 3. COLLECTOR 1 4. EMITTER 1 5. BASE 2 6. COLLECTOR 2</p> | <p>STYLE 3: PIN 1. ENABLE 2. N/C 3. R BOOST 4. Vz 5. V in 6. V out</p> | <p>STYLE 4: PIN 1. N/C 2. V in 3. NOT USED 4. GROUND 5. ENABLE 6. LOAD</p> | <p>STYLE 5: PIN 1. EMITTER 2 2. BASE 2 3. COLLECTOR 1 4. EMITTER 1 5. BASE 1 6. COLLECTOR 2</p> | <p>STYLE 6: PIN 1. COLLECTOR 2. COLLECTOR 3. BASE 4. EMITTER 5. COLLECTOR 6. COLLECTOR</p> |
| <p>STYLE 7: PIN 1. COLLECTOR 2. COLLECTOR 3. BASE 4. N/C 5. COLLECTOR 6. EMITTER</p> | <p>STYLE 8: PIN 1. Vbus 2. D(in) 3. D(in)+ 4. D(out)+ 5. D(out) 6. GND</p> | <p>STYLE 9: PIN 1. LOW VOLTAGE GATE 2. DRAIN 3. SOURCE 4. DRAIN 5. DRAIN 6. HIGH VOLTAGE GATE</p> | <p>STYLE 10: PIN 1. D(OUT)+ 2. GND 3. D(OUT)- 4. D(IN)- 5. VBUS 6. D(IN)+</p> | <p>STYLE 11: PIN 1. SOURCE 1 2. DRAIN 2 3. DRAIN 2 4. SOURCE 2 5. GATE 1 6. DRAIN 1/GATE 2</p> | <p>STYLE 12: PIN 1. I/O 2. GROUND 3. I/O 4. I/O 5. VCC 6. I/O</p> |
| <p>STYLE 13: PIN 1. GATE 1 2. SOURCE 2 3. GATE 2 4. DRAIN 2 5. SOURCE 1 6. DRAIN 1</p> | <p>STYLE 14: PIN 1. ANODE 2. SOURCE 3. GATE 4. CATHODE/DRAIN 5. CATHODE/DRAIN 6. CATHODE/DRAIN</p> | <p>STYLE 15: PIN 1. ANODE 2. SOURCE 3. GATE 4. DRAIN 5. N/C 6. CATHODE</p> | <p>STYLE 16: PIN 1. ANODE/CATHODE 2. BASE 3. EMITTER 4. COLLECTOR 5. ANODE 6. CATHODE</p> | <p>STYLE 17: PIN 1. EMITTER 2. BASE 3. ANODE/CATHODE 4. ANODE 5. CATHODE 6. COLLECTOR</p> | |

RECOMMENDED SOLDERING FOOTPRINT*



DIMENSIONS: MILLIMETERS

GENERIC MARKING DIAGRAM*



- | | |
|--|---|
| <p>XXX = Specific Device Code A = Assembly Location Y = Year W = Work Week ▪ = Pb-Free Package</p> | <p>XXX = Specific Device Code M = Date Code ▪ = Pb-Free Package</p> |
|--|---|

*For additional information on our Pb-Free strategy and soldering details, please download the ON Semiconductor Soldering and Mounting Techniques Reference Manual, SOLDERRM/D.

*This information is generic. Please refer to device data sheet for actual part marking. Pb-Free indicator, "G" or microdot "▪", may or may not be present.

| | | |
|------------------|-------------|--|
| DOCUMENT NUMBER: | 98ASB14888C | Electronic versions are uncontrolled except when accessed directly from the Document Repository. Printed versions are uncontrolled except when stamped "CONTROLLED COPY" in red. |
| DESCRIPTION: | TSOP-6 | PAGE 1 OF 1 |

ON Semiconductor and ON are trademarks of Semiconductor Components Industries, LLC dba ON Semiconductor or its subsidiaries in the United States and/or other countries. ON Semiconductor reserves the right to make changes without further notice to any products herein. ON Semiconductor makes no warranty, representation or guarantee regarding the suitability of its products for any particular purpose, nor does ON Semiconductor assume any liability arising out of the application or use of any product or circuit, and specifically disclaims any and all liability, including without limitation special, consequential or incidental damages. ON Semiconductor does not convey any license under its patent rights nor the rights of others.



1
 SCALE 2:1

SC-88/SC70-6/SOT-363
 CASE 419B-02
 ISSUE Y

DATE 11 DEC 2012



- NOTES:
1. DIMENSIONING AND TOLERANCING PER ASME Y14.5M, 1994.
 2. CONTROLLING DIMENSION: MILLIMETERS.
 3. DIMENSIONS D AND E1 DO NOT INCLUDE MOLD FLASH, PROTRUSIONS, OR GATE BURRS. MOLD FLASH, PROTRUSIONS, OR GATE BURRS SHALL NOT EXCEED 0.20 PER END.
 4. DIMENSIONS D AND E1 AT THE OUTERMOST EXTREMES OF THE PLASTIC BODY AND DATUM H.
 5. DATUMS A AND B ARE DETERMINED AT DATUM H.
 6. DIMENSIONS b AND c APPLY TO THE FLAT SECTION OF THE LEAD BETWEEN 0.08 AND 0.15 FROM THE TIP.
 7. DIMENSION b DOES NOT INCLUDE DAMBAR PROTRUSION. ALLOWABLE DAMBAR PROTRUSION SHALL BE 0.08 TOTAL IN EXCESS OF DIMENSION b AT MAXIMUM MATERIAL CONDITION. THE DAMBAR CANNOT BE LOCATED ON THE LOWER RADIUS OF THE FOOT.

| DIM | MILLIMETERS | | | INCHES | | |
|-----|-------------|------|------|-----------|-------|-------|
| | MIN | NOM | MAX | MIN | NOM | MAX |
| A | --- | --- | 1.10 | --- | --- | 0.043 |
| A1 | 0.00 | --- | 0.10 | 0.000 | --- | 0.004 |
| A2 | 0.70 | 0.90 | 1.00 | 0.027 | 0.035 | 0.039 |
| b | 0.15 | 0.20 | 0.25 | 0.006 | 0.008 | 0.010 |
| C | 0.08 | 0.15 | 0.22 | 0.003 | 0.006 | 0.009 |
| D | 1.80 | 2.00 | 2.20 | 0.070 | 0.078 | 0.086 |
| E | 2.00 | 2.10 | 2.20 | 0.078 | 0.082 | 0.086 |
| E1 | 1.15 | 1.25 | 1.35 | 0.045 | 0.049 | 0.053 |
| e | 0.65 BSC | | | 0.026 BSC | | |
| L | 0.26 | 0.36 | 0.46 | 0.010 | 0.014 | 0.018 |
| L2 | 0.15 BSC | | | 0.006 BSC | | |
| aaa | 0.15 | | | 0.006 | | |
| bbb | 0.30 | | | 0.012 | | |
| ccc | 0.10 | | | 0.004 | | |
| ddd | 0.10 | | | 0.004 | | |

GENERIC MARKING DIAGRAM*



XXX = Specific Device Code
 M = Date Code*
 ▪ = Pb-Free Package

(Note: Microdot may be in either location)

*Date Code orientation and/or position may vary depending upon manufacturing location.

*This information is generic. Please refer to device data sheet for actual part marking. Pb-Free indicator, "G" or microdot "▪", may or may not be present. Some products may not follow the Generic Marking.

RECOMMENDED SOLDERING FOOTPRINT*



DIMENSIONS: MILLIMETERS

*For additional information on our Pb-Free strategy and soldering details, please download the ON Semiconductor Soldering and Mounting Techniques Reference Manual, SOLDERRM/D.

STYLES ON PAGE 2

| | | |
|-------------------------|-----------------------------|--|
| DOCUMENT NUMBER: | 98ASB42985B | Electronic versions are uncontrolled except when accessed directly from the Document Repository. Printed versions are uncontrolled except when stamped "CONTROLLED COPY" in red. |
| DESCRIPTION: | SC-88/SC70-6/SOT-363 | PAGE 1 OF 2 |

ON Semiconductor and ON are trademarks of Semiconductor Components Industries, LLC dba ON Semiconductor or its subsidiaries in the United States and/or other countries. ON Semiconductor reserves the right to make changes without further notice to any products herein. ON Semiconductor makes no warranty, representation or guarantee regarding the suitability of its products for any particular purpose, nor does ON Semiconductor assume any liability arising out of the application or use of any product or circuit, and specifically disclaims any and all liability, including without limitation special, consequential or incidental damages. ON Semiconductor does not convey any license under its patent rights nor the rights of others.

SC-88/SC70-6/SOT-363
CASE 419B-02
ISSUE Y

DATE 11 DEC 2012

| | | | | | |
|---|---|--|--|--|--|
| STYLE 1: PIN 1. EMITTER 2 2. BASE 2 3. COLLECTOR 1 4. EMITTER 1 5. BASE 1 6. COLLECTOR 2 | STYLE 2: CANCELLED | STYLE 3: CANCELLED | STYLE 4: PIN 1. CATHODE 2. CATHODE 3. COLLECTOR 4. EMITTER 5. BASE 6. ANODE | STYLE 5: PIN 1. ANODE 2. ANODE 3. COLLECTOR 4. EMITTER 5. BASE 6. CATHODE | STYLE 6: PIN 1. ANODE 2 2. N/C 3. CATHODE 1 4. ANODE 1 5. N/C 6. CATHODE 2 |
| STYLE 7: PIN 1. SOURCE 2 2. DRAIN 2 3. GATE 1 4. SOURCE 1 5. DRAIN 1 6. GATE 2 | STYLE 8: CANCELLED | STYLE 9: PIN 1. EMITTER 2 2. EMITTER 1 3. COLLECTOR 1 4. BASE 1 5. BASE 2 6. COLLECTOR 2 | STYLE 10: PIN 1. SOURCE 2 2. SOURCE 1 3. GATE 1 4. DRAIN 1 5. DRAIN 2 6. GATE 2 | STYLE 11: PIN 1. CATHODE 2 2. CATHODE 2 3. ANODE 1 4. CATHODE 1 5. CATHODE 1 6. ANODE 2 | STYLE 12: PIN 1. ANODE 2 2. ANODE 2 3. CATHODE 1 4. ANODE 1 5. ANODE 1 6. CATHODE 2 |
| STYLE 13: PIN 1. ANODE 2. N/C 3. COLLECTOR 4. EMITTER 5. BASE 6. CATHODE | STYLE 14: PIN 1. VREF 2. GND 3. GND 4. IOUT 5. VEN 6. VCC | STYLE 15: PIN 1. ANODE 1 2. ANODE 2 3. ANODE 3 4. CATHODE 3 5. CATHODE 2 6. CATHODE 1 | STYLE 16: PIN 1. BASE 1 2. EMITTER 2 3. COLLECTOR 2 4. BASE 2 5. EMITTER 1 6. COLLECTOR 1 | STYLE 17: PIN 1. BASE 1 2. EMITTER 1 3. COLLECTOR 2 4. BASE 2 5. EMITTER 2 6. COLLECTOR 1 | STYLE 18: PIN 1. VIN1 2. VCC 3. VOUT2 4. VIN2 5. GND 6. VOUT1 |
| STYLE 19: PIN 1. IOUT 2. GND 3. GND 4. V CC 5. V EN 6. V REF | STYLE 20: PIN 1. COLLECTOR 2. COLLECTOR 3. BASE 4. EMITTER 5. COLLECTOR 6. COLLECTOR | STYLE 21: PIN 1. ANODE 1 2. N/C 3. ANODE 2 4. CATHODE 2 5. N/C 6. CATHODE 1 | STYLE 22: PIN 1. D1 (i) 2. GND 3. D2 (i) 4. D2 (c) 5. VBUS 6. D1 (c) | STYLE 23: PIN 1. Vn 2. CH1 3. Vp 4. N/C 5. CH2 6. N/C | STYLE 24: PIN 1. CATHODE 2. ANODE 3. CATHODE 4. CATHODE 5. CATHODE 6. CATHODE |
| STYLE 25: PIN 1. BASE 1 2. CATHODE 3. COLLECTOR 2 4. BASE 2 5. EMITTER 6. COLLECTOR 1 | STYLE 26: PIN 1. SOURCE 1 2. GATE 1 3. DRAIN 2 4. SOURCE 2 5. GATE 2 6. DRAIN 1 | STYLE 27: PIN 1. BASE 2 2. BASE 1 3. COLLECTOR 1 4. EMITTER 1 5. EMITTER 2 6. COLLECTOR 2 | STYLE 28: PIN 1. DRAIN 2. DRAIN 3. GATE 4. SOURCE 5. DRAIN 6. DRAIN | STYLE 29: PIN 1. ANODE 2. ANODE 3. COLLECTOR 4. EMITTER 5. BASE/ANODE 6. CATHODE | STYLE 30: PIN 1. SOURCE 1 2. DRAIN 2 3. DRAIN 2 4. SOURCE 2 5. GATE 1 6. DRAIN 1 |

Note: Please refer to datasheet for style callout. If style type is not called out in the datasheet refer to the device datasheet pinout or pin assignment.

| | | |
|-------------------------|-----------------------------|--|
| DOCUMENT NUMBER: | 98ASB42985B | Electronic versions are uncontrolled except when accessed directly from the Document Repository. Printed versions are uncontrolled except when stamped "CONTROLLED COPY" in red. |
| DESCRIPTION: | SC-88/SC70-6/SOT-363 | PAGE 2 OF 2 |

ON Semiconductor and  are trademarks of Semiconductor Components Industries, LLC dba ON Semiconductor or its subsidiaries in the United States and/or other countries. ON Semiconductor reserves the right to make changes without further notice to any products herein. ON Semiconductor makes no warranty, representation or guarantee regarding the suitability of its products for any particular purpose, nor does ON Semiconductor assume any liability arising out of the application or use of any product or circuit, and specifically disclaims any and all liability, including without limitation special, consequential or incidental damages. ON Semiconductor does not convey any license under its patent rights nor the rights of others.

MECHANICAL CASE OUTLINE

PACKAGE DIMENSIONS

ON Semiconductor®



UDFN6, 1.2x1.0, 0.4P CASE 517AA-01 ISSUE D

DATE 03 SEP 2010

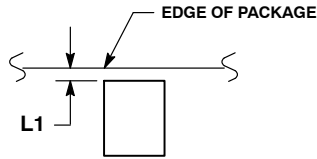

DETAIL A
Bottom View
(Optional)

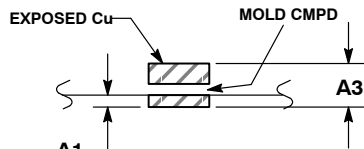

DETAIL B
Side View
(Optional)

NOTES:

1. DIMENSIONING AND TOLERANCING PER ASME Y14.5M, 1994.
2. CONTROLLING DIMENSION: MILLIMETERS.
3. DIMENSION b APPLIES TO PLATED TERMINAL AND IS MEASURED BETWEEN 0.25 AND 0.30 mm FROM TERMINAL.
4. COPLANARITY APPLIES TO THE EXPOSED PAD AS WELL AS THE TERMINALS.

| MILLIMETERS | | |
|-------------|-------|------|
| DIM | MIN | MAX |
| A | 0.45 | 0.55 |
| A1 | 0.00 | 0.05 |
| A3 | 0.127 | REF |
| b | 0.15 | 0.25 |
| D | 1.20 | BSC |
| E | 1.00 | BSC |
| e | 0.40 | BSC |
| L | 0.30 | 0.40 |
| L1 | 0.00 | 0.15 |
| L2 | 0.40 | 0.50 |

GENERIC MARKING DIAGRAM*



X = Specific Device Code
M = Date Code

*This information is generic. Please refer to device data sheet for actual part marking. Pb-Free indicator, "G" or microdot "▪", may or may not be present.

MOUNTING FOOTPRINT*

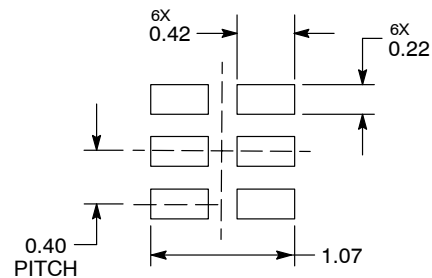

DIMENSIONS: MILLIMETERS

*For additional information on our Pb-Free strategy and soldering details, please download the ON Semiconductor Soldering and Mounting Techniques Reference Manual, SOLDERRM/D.

| | | |
|-------------------------|----------------------------------|--|
| DOCUMENT NUMBER: | 98AON22068D | Electronic versions are uncontrolled except when accessed directly from the Document Repository. Printed versions are uncontrolled except when stamped "CONTROLLED COPY" in red. |
| DESCRIPTION: | 6 PIN UDFN, 1.2X1.0, 0.4P | PAGE 1 OF 1 |

ON Semiconductor and ON are trademarks of Semiconductor Components Industries, LLC dba ON Semiconductor or its subsidiaries in the United States and/or other countries. ON Semiconductor reserves the right to make changes without further notice to any products herein. ON Semiconductor makes no warranty, representation or guarantee regarding the suitability of its products for any particular purpose, nor does ON Semiconductor assume any liability arising out of the application or use of any product or circuit, and specifically disclaims any and all liability, including without limitation special, consequential or incidental damages. ON Semiconductor does not convey any license under its patent rights nor the rights of others.

MECHANICAL CASE OUTLINE PACKAGE DIMENSIONS



SCALE 4:1

UDFN6, 1.45x1.0, 0.5P
CASE 517AQ
ISSUE O

DATE 15 MAY 2008



DETAIL A
OPTIONAL
CONSTRUCTIONS

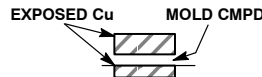

DETAIL B
OPTIONAL
CONSTRUCTIONS

NOTES:

1. DIMENSIONING AND TOLERANCING PER ASME Y14.5M, 1994.
2. CONTROLLING DIMENSION: MILLIMETERS.
3. DIMENSION b APPLIES TO PLATED TERMINAL AND IS MEASURED BETWEEN 0.15 AND 0.30 mm FROM THE TERMINAL TIP.

| MILLIMETERS | | |
|-------------|----------|------|
| DIM | MIN | MAX |
| A | 0.45 | 0.55 |
| A1 | 0.00 | 0.05 |
| A2 | 0.07 REF | |
| b | 0.20 | 0.30 |
| D | 1.45 BSC | |
| E | 1.00 BSC | |
| e | 0.50 BSC | |
| L | 0.30 | 0.40 |
| L1 | --- | 0.15 |

MOUNTING FOOTPRINT



DIMENSIONS: MILLIMETERS

*For additional information on our Pb-Free strategy and soldering details, please download the ON Semiconductor Soldering and Mounting Techniques Reference Manual, SOLDERRM/D.

**GENERIC
MARKING DIAGRAM***



X = Specific Device Code
M = Date Code

*This information is generic. Please refer to device data sheet for actual part marking. Pb-Free indicator, "G" or microdot "▪", may or may not be present.

| | | |
|-------------------------|------------------------------|--|
| DOCUMENT NUMBER: | 98AON30313E | Electronic versions are uncontrolled except when accessed directly from the Document Repository. Printed versions are uncontrolled except when stamped "CONTROLLED COPY" in red. |
| DESCRIPTION: | UDFN6, 1.45x1.0, 0.5P | PAGE 1 OF 1 |

onsemi and ONsemi are trademarks of Semiconductor Components Industries, LLC dba onsemi or its subsidiaries in the United States and/or other countries. onsemi reserves the right to make changes without further notice to any products herein. onsemi makes no warranty, representation or guarantee regarding the suitability of its products for any particular purpose, nor does onsemi assume any liability arising out of the application or use of any product or circuit, and specifically disclaims any and all liability, including without limitation special, consequential or incidental damages. onsemi does not convey any license under its patent rights nor the rights of others.

MECHANICAL CASE OUTLINE PACKAGE DIMENSIONS



UDFN6, 1x1, 0.35P
CASE 517BX
ISSUE O

SCALE 4:1

DATE 18 MAY 2011



NOTES:

1. DIMENSIONING AND TOLERANCING PER ASME Y14.5M, 1994.
2. CONTROLLING DIMENSION: MILLIMETERS.
3. DIMENSION b APPLIES TO PLATED TERMINAL AND IS MEASURED BETWEEN 0.15 AND 0.20 MM FROM TERMINAL TIP.
4. PACKAGE DIMENSIONS EXCLUSIVE OF BURRS AND MOLD FLASH.

| MILLIMETERS | | |
|-------------|------|------|
| DIM | MIN | MAX |
| A | 0.45 | 0.55 |
| A1 | 0.00 | 0.05 |
| A3 | 0.13 | REF |
| b | 0.12 | 0.22 |
| D | 1.00 | BSC |
| E | 1.00 | BSC |
| e | 0.35 | BSC |
| L | 0.25 | 0.35 |
| L1 | 0.30 | 0.40 |

**RECOMMENDED
SOLDERING FOOTPRINT***

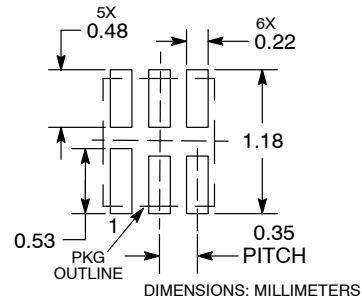

*For additional information on our Pb-Free strategy and soldering details, please download the ON Semiconductor Soldering and Mounting Techniques Reference Manual, SOLDERRM/D.

**GENERIC
MARKING DIAGRAM***

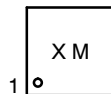

X = Specific Device Code
M = Date Code

*This information is generic. Please refer to device data sheet for actual part marking. Pb-Free indicator, "G" or microdot "▪", may or may not be present. Some products may not follow the Generic Marking.

| | | |
|-------------------------|--------------------------|--|
| DOCUMENT NUMBER: | 98AON56787E | Electronic versions are uncontrolled except when accessed directly from the Document Repository. Printed versions are uncontrolled except when stamped "CONTROLLED COPY" in red. |
| DESCRIPTION: | UDFN6, 1x1, 0.35P | PAGE 1 OF 1 |

onsemi and ONSEMI are trademarks of Semiconductor Components Industries, LLC dba onsemi or its subsidiaries in the United States and/or other countries. onsemi reserves the right to make changes without further notice to any products herein. onsemi makes no warranty, representation or guarantee regarding the suitability of its products for any particular purpose, nor does onsemi assume any liability arising out of the application or use of any product or circuit, and specifically disclaims any and all liability, including without limitation special, consequential or incidental damages. onsemi does not convey any license under its patent rights nor the rights of others.

onsemi, **Onsemi**, and other names, marks, and brands are registered and/or common law trademarks of Semiconductor Components Industries, LLC dba "**onsemi**" or its affiliates and/or subsidiaries in the United States and/or other countries. **onsemi** owns the rights to a number of patents, trademarks, copyrights, trade secrets, and other intellectual property. A listing of **onsemi**'s product/patent coverage may be accessed at www.onsemi.com/site/pdf/Patent-Marking.pdf. **onsemi** reserves the right to make changes at any time to any products or information herein, without notice. The information herein is provided "as-is" and **onsemi** makes no warranty, representation or guarantee regarding the accuracy of the information, product features, availability, functionality, or suitability of its products for any particular purpose, nor does **onsemi** assume any liability arising out of the application or use of any product or circuit, and specifically disclaims any and all liability, including without limitation special, consequential or incidental damages. Buyer is responsible for its products and applications using **onsemi** products, including compliance with all laws, regulations and safety requirements or standards, regardless of any support or applications information provided by **onsemi**. "Typical" parameters which may be provided in **onsemi** data sheets and/or specifications can and do vary in different applications and actual performance may vary over time. All operating parameters, including "Typicals" must be validated for each customer application by customer's technical experts. **onsemi** does not convey any license under any of its intellectual property rights nor the rights of others. **onsemi** products are not designed, intended, or authorized for use as a critical component in life support systems or any FDA Class 3 medical devices or medical devices with a same or similar classification in a foreign jurisdiction or any devices intended for implantation in the human body. Should Buyer purchase or use **onsemi** products for any such unintended or unauthorized application, Buyer shall indemnify and hold **onsemi** and its officers, employees, subsidiaries, affiliates, and distributors harmless against all claims, costs, damages, and expenses, and reasonable attorney fees arising out of, directly or indirectly, any claim of personal injury or death associated with such unintended or unauthorized use, even if such claim alleges that **onsemi** was negligent regarding the design or manufacture of the part. **onsemi** is an Equal Opportunity/Affirmative Action Employer. This literature is subject to all applicable copyright laws and is not for resale in any manner.

PUBLICATION ORDERING INFORMATION

LITERATURE FULFILLMENT:

Email Requests to: orderlit@onsemi.com

onsemi Website: www.onsemi.com

TECHNICAL SUPPORT

North American Technical Support:

Voice Mail: 1 800-282-9855 Toll Free USA/Canada

Phone: 011 421 33 790 2910

Europe, Middle East and Africa Technical Support:

Phone: 00421 33 790 2910

For additional information, please contact your local Sales Representative