

MJE5850, MJE5851, MJE5852

Switch-mode Series PNP Silicon Power Transistors

The MJE5850, MJE5851 and the MJE5852 transistors are designed for high-voltage, high-speed, power switching in inductive circuits where fall time is critical. They are particularly suited for line operated switch-mode applications.

Features

- Switching Regulators
- Inverters
- Solenoid and Relay Drivers
- Motor Controls
- Deflection Circuits
- Fast Turn-Off Times
- Operating Temperature Range –65 to +150°C
- 100°C Performance Specified for:
 - ◆ Reversed Biased SOA with Inductive Loads
 - ◆ Switching Times with Inductive Loads
 - ◆ Saturation Voltages
 - ◆ Leakage Currents
- Complementary to the MJE13007 Series
- These Devices are Pb-Free and are RoHS Compliant*

MAXIMUM RATINGS

Rating	Symbol	Value	Unit
Collector-Emitter Voltage MJE5850 MJE5851 MJE5852	$V_{CEO(sus)}$	300 350 400	Vdc
Collector-Emitter Voltage MJE5850 MJE5851 MJE5852	V_{CEV}	350 400 450	Vdc
Emitter Base Voltage	V_{EB}	6.0	Vdc
Collector Current – Continuous (Note 1)	I_C	8.0	Adc
Collector Current – Peak (Note 1)	I_{CM}	16	Adc
Base Current – Continuous (Note 1)	I_B	4.0	Adc
Base Current – Peak (Note 1)	I_{BM}	8.0	Adc
Total Power Dissipation @ $T_C = 25^\circ\text{C}$ Derate above 25°C	P_D	80 0.640	W W/°C
Operating and Storage Junction Temperature Range	T_J, T_{stg}	–65 to 150	°C

Stresses exceeding those listed in the Maximum Ratings table may damage the device. If any of these limits are exceeded, device functionality should not be assumed, damage may occur and reliability may be affected.

1. Pulse Test: Pulse Width = 5 ms, Duty Cycle $\leq 10\%$.

*For additional information on our Pb-Free strategy and soldering details, please download the ON Semiconductor Soldering and Mounting Techniques Reference Manual, SOLDERRM/D.



ON Semiconductor®

www.onsemi.com

**8 AMPERE
PCP SILICON
POWER TRANSISTORS
300–350–400 VOLTS
80 WATTS**

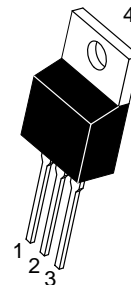
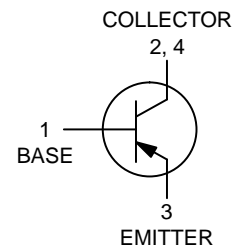

TO-220
CASE 221A-09
STYLE 1

MARKING DIAGRAM

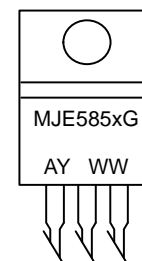

MJE585x = Device Code
x = 0, 1, or 2
G = Pb-Free Package
A = Assembly Location
Y = Year
WW = Work Week

ORDERING INFORMATION

See detailed ordering and shipping information in the package dimensions section on page 7 of this data sheet.

MJE5850, MJE5851, MJE5852

THERMAL CHARACTERISTICS

Rating	Symbol	Max	Unit
Thermal Resistance, Junction-to-Case	$R_{\theta JC}$	1.25	$^{\circ}C/W$
Maximum Lead Temperature for Soldering Purposes: 1/8" from Case for 5 Seconds	T_L	275	$^{\circ}C$

ELECTRICAL CHARACTERISTICS ($T_C = 25^{\circ}C$ unless otherwise noted)

Characteristic	Symbol	Min	Typ	Max	Unit
----------------	--------	-----	-----	-----	------

OFF CHARACTERISTICS

Collector-Emitter Sustaining Voltage ($I_C = 10\text{ mA}$, $I_B = 0$) MJE5850 MJE5851 MJE5852	$V_{CEO(sus)}$	300 350 400	- - -	- - -	Vdc
Collector Cutoff Current ($V_{CEV} = \text{Rated Value}$, $V_{BE(off)} = 1.5\text{ Vdc}$) ($V_{CEV} = \text{Rated Value}$, $V_{BE(off)} = 1.5\text{ Vdc}$, $T_C = 100^{\circ}C$)	I_{CEV}	- -	- -	0.5 2.5	mAdc
Collector Cutoff Current ($V_{CE} = \text{Rated } V_{CEV}$, $R_{BE} = 50\ \Omega$, $T_C = 100^{\circ}C$)	I_{CER}	-	-	3.0	mAdc
Emitter Cutoff Current ($V_{EB} = 6.0\text{ Vdc}$, $I_C = 0$)	I_{EBO}	-	-	1.0	mAdc

SECOND BREAKDOWN

Second Breakdown Collector Current with base forward biased	$I_{S/b}$	See Figure 12			
Clamped Inductive SOA with base reverse biased	RBSOA	See Figure 13			

ON CHARACTERISTICS (Note 2)

DC Current Gain ($I_C = 2.0\text{ Adc}$, $V_{CE} = 5\text{ Vdc}$) ($I_C = 5.0\text{ Adc}$, $V_{CE} = 5\text{ Vdc}$)	h_{FE}	15 5	- -	- -	-
Collector-Emitter Saturation Voltage ($I_C = 4.0\text{ Adc}$, $I_B = 1.0\text{ Adc}$) ($I_C = 8.0\text{ Adc}$, $I_B = 3.0\text{ Adc}$) ($I_C = 4.0\text{ Adc}$, $I_B = 1.0\text{ Adc}$, $T_C = 100^{\circ}C$)	$V_{CE(sat)}$	- - -	- - -	2.0 5.0 2.5	Vdc
Base-Emitter Saturation Voltage ($I_C = 4.0\text{ Adc}$, $I_B = 1.0\text{ Adc}$) ($I_C = 4.0\text{ Adc}$, $I_B = 1.0\text{ Adc}$, $T_C = 100^{\circ}C$)	$V_{BE(sat)}$	- -	- -	1.5 1.5	Vdc

DYNAMIC CHARACTERISTICS

Output Capacitance ($V_{CB} = 10\text{ Vdc}$, $I_E = 0$, $f_{test} = 1.0\text{ kHz}$)	C_{ob}	-	270	-	pF
--	----------	---	-----	---	----

SWITCHING CHARACTERISTICS

Resistive Load (Table 1)						
Delay Time	$(V_{CC} = 250\text{ Vdc}$, $I_C = 4.0\text{ A}$, $I_{B1} = 1.0\text{ A}$, $t_p = 50\ \mu s$, Duty Cycle $\leq 2\%$)	t_d	-	0.025	0.1	μs
Rise Time		t_r	-	0.100	0.5	μs
Storage Time	$(V_{CC} = 250\text{ Vdc}$, $I_C = 4.0\text{ A}$, $I_{B1} = 1.0\text{ A}$, $V_{BE(off)} = 5\text{ Vdc}$, $t_p = 50\ \mu s$, Duty Cycle $\leq 2\%$)	t_s	-	0.60	2.0	μs
Fall Time		t_f	-	0.11	0.5	μs
Inductive Load, Clamped (Table 1)						
Storage Time	$(I_{CM} = 4\text{ A}$, $V_{CEM} = 250\text{ V}$, $I_{B1} = 1.0\text{ A}$, $V_{BE(off)} = 5\text{ Vdc}$, $T_C = 100^{\circ}C$)	t_{sv}	-	0.8	3.0	μs
Crossover Time		t_c	-	0.4	1.5	μs
Fall Time		t_{fi}	-	0.1	-	μs
Storage Time	$(I_{CM} = 4\text{ A}$, $V_{CEM} = 250\text{ V}$, $I_{B1} = 1.0\text{ A}$, $V_{BE(off)} = 5\text{ Vdc}$, $T_C = 25^{\circ}C$)	t_{sv}	-	0.5	-	μs
Crossover Time		t_c	-	0.125	-	μs
Fall Time		t_{fi}	-	0.1	-	μs

Product parametric performance is indicated in the Electrical Characteristics for the listed test conditions, unless otherwise noted. Product performance may not be indicated by the Electrical Characteristics if operated under different conditions.

2. Pulse Test: PW = 300 μs . Duty Cycle $\leq 2\%$

TYPICAL ELECTRICAL CHARACTERISTICS

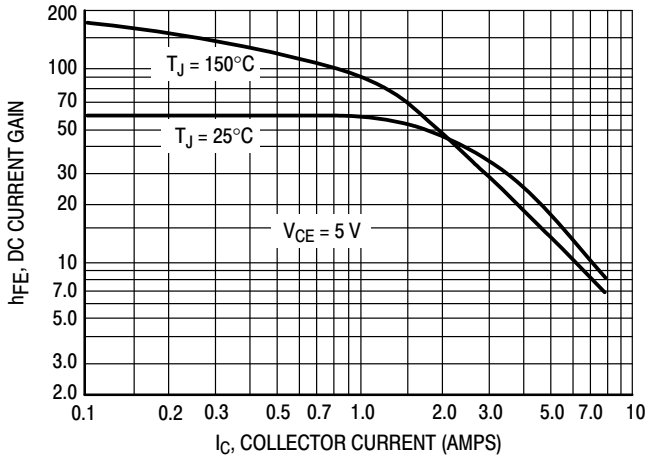

Figure 1. DC Current Gain

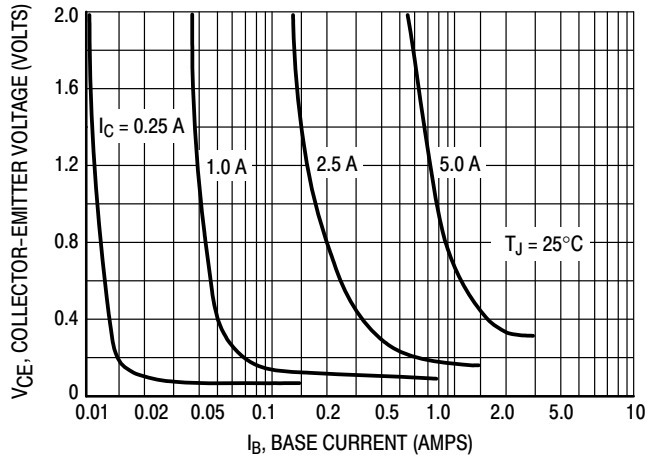

Figure 2. Collector Saturation Region

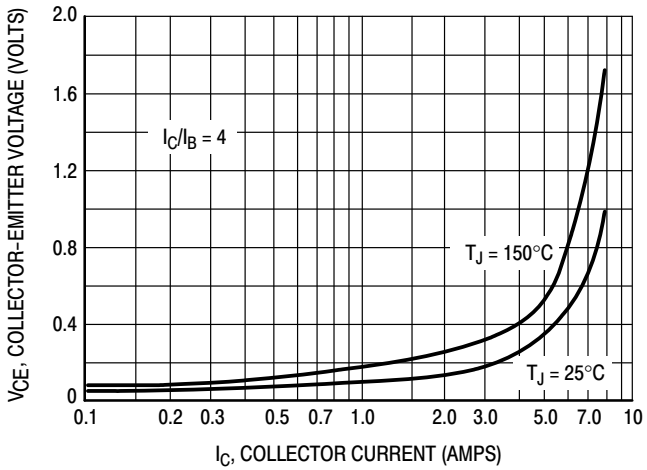

Figure 3. Collector-Emitter Saturation Voltage

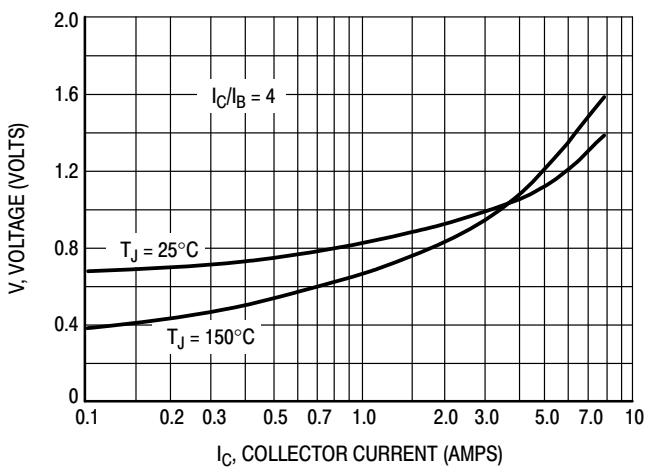

Figure 4. Base-Emitter Voltage

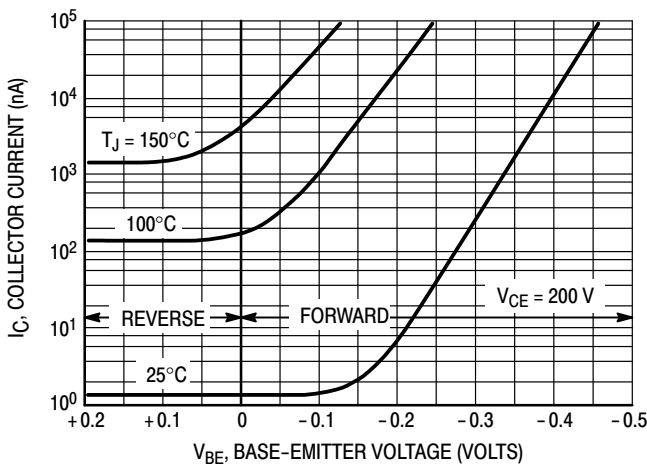

Figure 5. Collector Cutoff Region

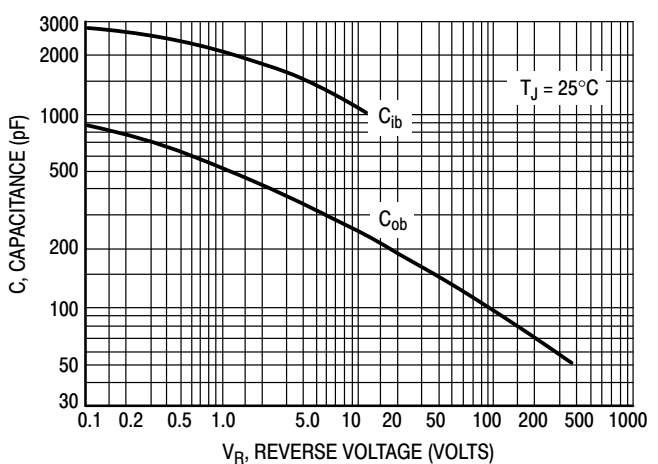

Figure 6. Capacitance

MJE5850, MJE5851, MJE5852

Table 1. TEST CONDITIONS FOR DYNAMIC PERFORMANCE

	$V_{CE0(sus)}$	RBSOA AND INDUCTIVE SWITCHING	RESISTIVE SWITCHING
INPUT CONDITIONS	<p>PW Varied to Attain $I_C = 100 \text{ mA}$</p>	<p>$-V$ adjusted to obtain desired I_{B1} $+V$ adjusted to obtain desired $V_{BE(off)}$</p>	<p>TURN-ON TIME</p> <p>I_{B1} adjusted to obtain the forced η_{FE} desired</p> <p>TURN-OFF TIME</p> <p>Use inductive switching driver as the input to the resistive test circuit.</p>
CIRCUIT VALUES	$L_{coil} = 80 \text{ mH}$, $V_{CC} = 10 \text{ V}$ $R_{coil} = 0.7 \Omega$	$L_{coil} = 180 \mu\text{H}$ $R_{coil} = 0.05 \Omega$ $V_{CC} = 20 \text{ V}$ $V_{clamp} = 250 \text{ V}$ R_B adjusted to attain desired I_{B1}	$V_{CC} = 250 \text{ V}$ $R_L = 62 \Omega$ Pulse Width = $10 \mu\text{s}$
TEST CIRCUITS	<p>INDUCTIVE TEST CIRCUIT</p> <p>SEE ABOVE FOR DETAILED CONDITIONS</p>	<p>OUTPUT WAVEFORMS</p> <p>t_1 Adjusted to Obtain I_C</p> $t_1 \approx \frac{L_{coil} (I_{CM})}{V_{CC}}$ $t_2 \approx \frac{L_{coil} (I_{CM})}{V_{Clamp}}$ <p>Test Equipment Scope — Tektronix 475 or Equivalent</p>	<p>RESISTIVE TEST CIRCUIT</p>

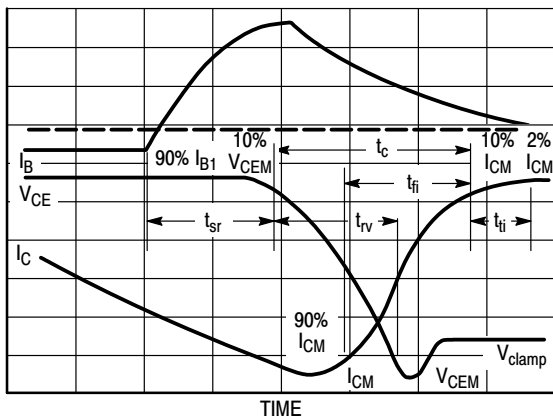

Figure 7. Inductive Switching Measurements

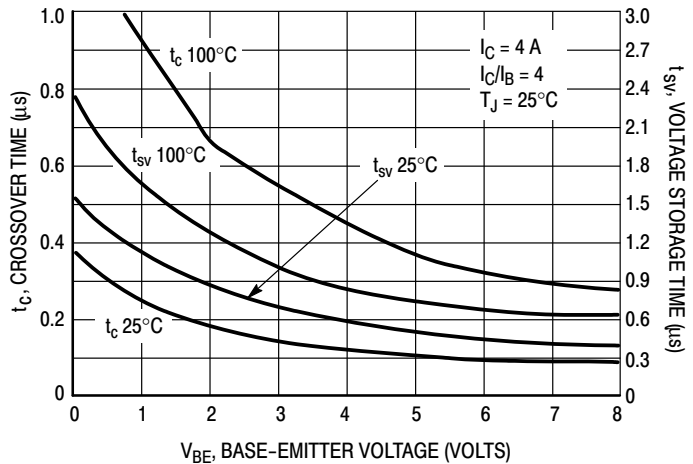

Figure 8. Inductive Switching Times

SWITCHING TIMES NOTE

In resistive switching circuits, rise, fall, and storage times have been defined and apply to both current and voltage waveforms since they are in phase. However, for inductive loads which are common to SWITCHMODE power supplies and hammer drivers, current and voltage waveforms are not in phase. Therefore, separate measurements must be made on each waveform to determine the total switching time. For this reason, the following new terms have been defined.

- t_{SV} = Voltage Storage Time, 90% I_{B1} to 10% V_{CEM}
- t_{RV} = Voltage Rise Time, 10–90% V_{CEM}
- t_{fi} = Current Fall Time, 90–10% I_{CM}
- t_{ti} = Current Tail, 10–2% I_{CM}
- t_c = Crossover Time, 10% V_{CEM} to 10% I_{CM}

An enlarged portion of the inductive switching waveform is shown in Figure 7 to aid on the visual identity of these terms.

For the designer, there is minimal switching loss during storage time and the predominant switching power losses occur during the crossover interval and can be obtained using the standard equation from AN-222A:

$$P_{SWT} = 1/2 V_{CC} I_C(t_c) f$$

In general, $t_{RV} + t_{fi} \approx t_c$. However, at lower test currents this relationship may not be valid.

As is common with most switching transistors, resistive switching is specified at 25°C and has become a benchmark for designers. However, for designers of high frequency converter circuits, the user oriented specifications which make this a “SWITCHMODE” transistor are the inductive switching speeds (t_c and t_{SV}) which are guaranteed at 100°C.

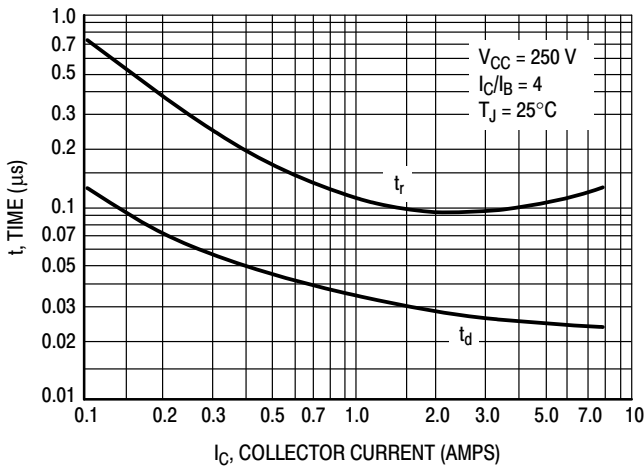

Figure 9. Turn-On Switching Times

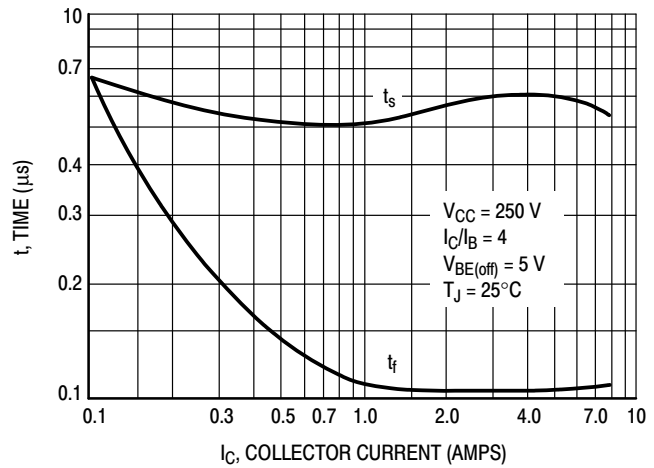

Figure 10. Turn-Off Switching Time

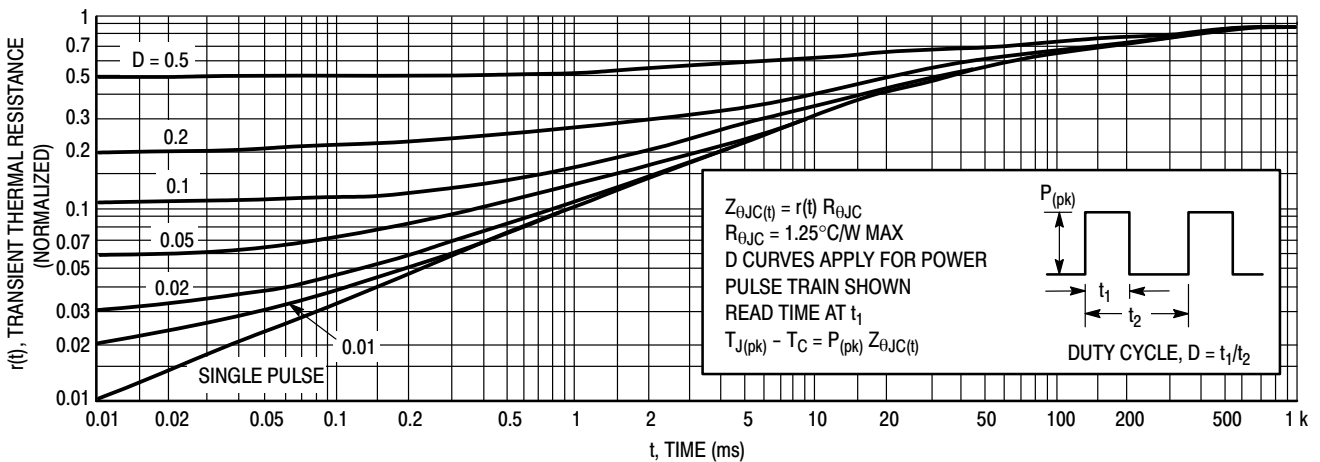

Figure 11. Typical Thermal Response [$Z_{\theta JC}(t)$]

MJE5850, MJE5851, MJE5852

The Safe Operating Area figures shown in Figures 12 and 13 are specified for these devices under the test conditions shown.

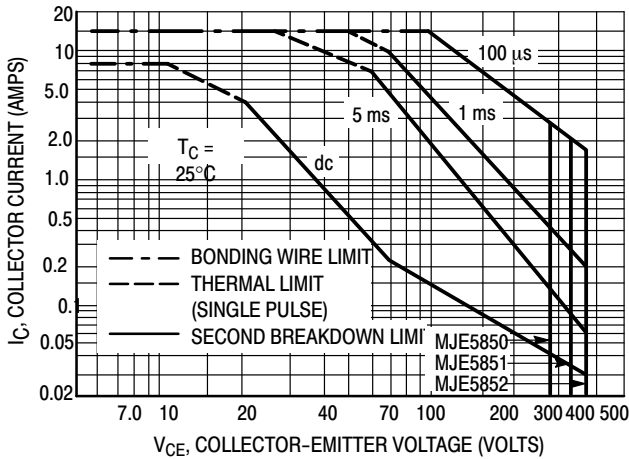

Figure 12. Maximum Forward Bias Safe Operating Area

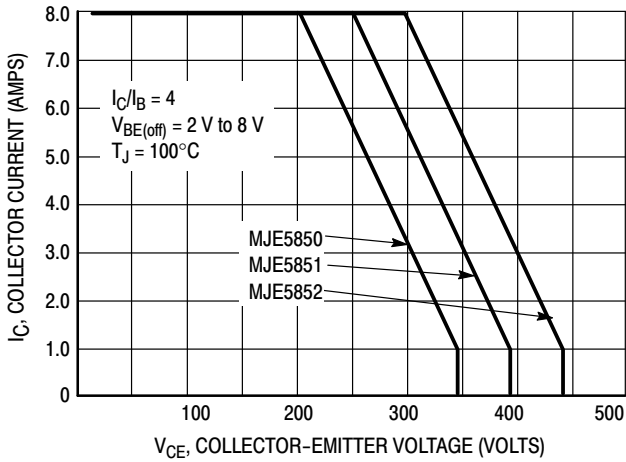

Figure 13. RBSOA, Maximum Reverse Bias Safe Operating Area

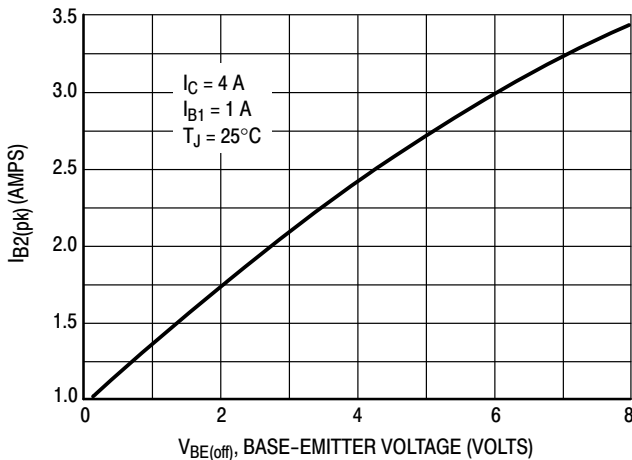

Figure 14. Peak Reverse Base Current

Safe Operating Area Information

Forward Bias

There are two limitations on the power handling ability of a transistor average junction temperature and second breakdown. Safe operating area curves indicate $I_C - V_{CE}$ limits of the transistor that must be observed for reliable operation, i.e., the transistor must not be subjected to greater dissipation than the curves indicate.

The data of Figure 12 is based on $T_C = 25^\circ\text{C}$; $T_{J(pk)}$ is variable depending on power level. Second breakdown pulse limits are valid for duty cycles to 10% but must be derated when $T_C \geq 25^\circ\text{C}$. Second breakdown limitations do not derate the same as thermal limitations. Allowable current at the voltages shown on Figure 12 may be found at any case temperature by using the appropriate curve on Figure 15.

$T_{J(pk)}$ may be calculated from the data in Figure 11. At high case temperatures, thermal limitations will reduce the power that can be handled to values less than the limitations imposed by second breakdown.

Reverse Bias

For inductive loads, high voltage and high current must be sustained simultaneously during turn-off, in most cases, with the base to emitter junction reverse biased. Under these conditions the collector voltage must be held to a safe level at or below a specific value of collector current. This can be accomplished by several means such as active clamping, RC snubbing, load line shaping, etc. The safe level for these devices is specified as Reverse Bias Safe Operating Area and represents the voltage-current condition allowable during reverse biased turn-off. This rating is verified under clamped conditions so that the device is never subjected to an avalanche mode. Figure 13 gives the RBSOA characteristics.

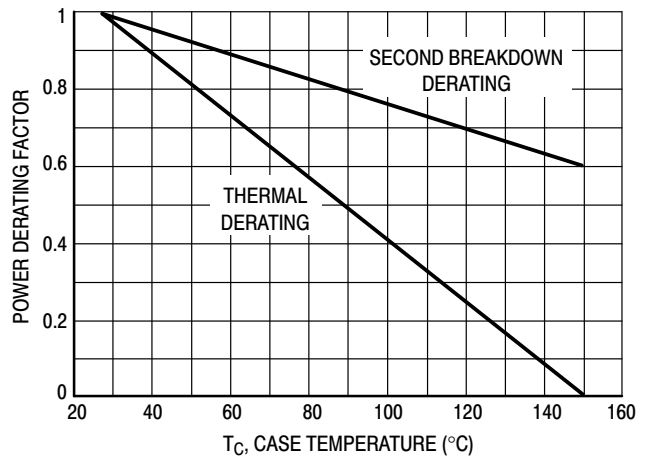

Figure 15. Forward Bias Power Derating

MJE5850, MJE5851, MJE5852

ORDERING INFORMATION

Device	Package	Shipping
MJE5850G	TO-220 (Pb-Free)	50 Units / Rail
MJE5851G	TO-220 (Pb-Free)	50 Units / Rail
MJE5852G	TO-220 (Pb-Free)	50 Units / Rail

MECHANICAL CASE OUTLINE PACKAGE DIMENSIONS

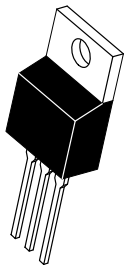

SCALE 1:1

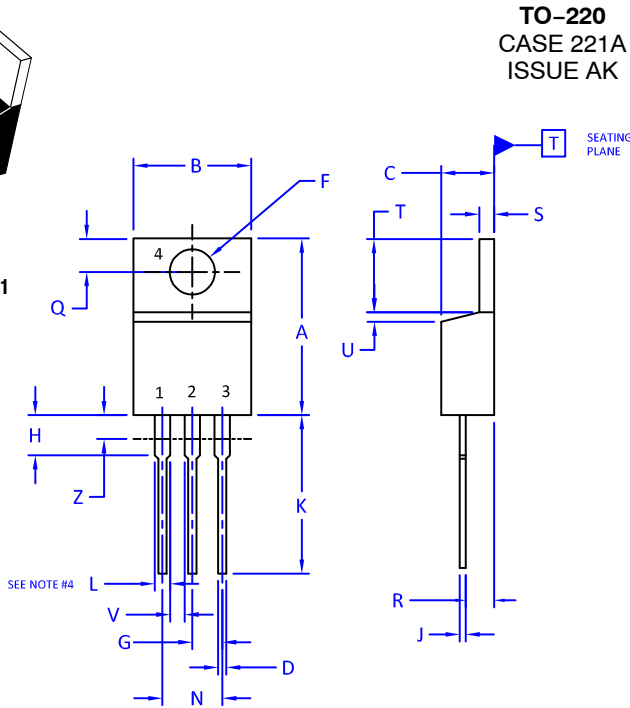

TO-220 CASE 221A ISSUE AK

DATE 13 JAN 2022

NOTES:

1. DIMENSIONING AND TOLERANCING PER ANSI Y14.5M, 2009.
2. CONTROLLING DIMENSION: INCHES
3. DIMENSION Z DEFINES A ZONE WHERE ALL BODY AND LEAD IRREGULARITIES ARE ALLOWED.
4. MAX WIDTH FOR F102 DEVICE = 1.35MM

DIM	INCHES		MILLIMETERS	
	MIN.	MAX.	MIN.	MAX.
A	0.570	0.620	14.48	15.75
B	0.380	0.415	9.66	10.53
C	0.160	0.190	4.07	4.83
D	0.025	0.038	0.64	0.96
F	0.142	0.161	3.60	4.09
G	0.095	0.105	2.42	2.66
H	0.110	0.161	2.80	4.10
J	0.014	0.024	0.36	0.61
K	0.500	0.562	12.70	14.27
L	0.045	0.060	1.15	1.52
N	0.190	0.210	4.83	5.33
Q	0.100	0.120	2.54	3.04
R	0.080	0.110	2.04	2.79
S	0.045	0.055	1.15	1.41
T	0.235	0.255	5.97	6.47
U	0.000	0.050	0.00	1.27
V	0.045	---	1.15	---
Z	---	0.080	---	2.04

STYLE 1:
PIN 1. BASE
2. COLLECTOR
3. EMITTER
4. COLLECTOR

STYLE 2:
PIN 1. BASE
2. EMITTER
3. COLLECTOR
4. EMITTER

STYLE 3:
PIN 1. CATHODE
2. ANODE
3. GATE
4. ANODE

STYLE 4:
PIN 1. MAIN TERMINAL 1
2. MAIN TERMINAL 2
3. GATE
4. MAIN TERMINAL 2

STYLE 5:
PIN 1. GATE
2. DRAIN
3. SOURCE
4. DRAIN

STYLE 6:
PIN 1. ANODE
2. CATHODE
3. ANODE
4. CATHODE

STYLE 7:
PIN 1. CATHODE
2. ANODE
3. CATHODE
4. ANODE

STYLE 8:
PIN 1. CATHODE
2. ANODE
3. EXTERNAL TRIP/DELAY
4. ANODE

STYLE 9:
PIN 1. GATE
2. COLLECTOR
3. EMITTER
4. COLLECTOR

STYLE 10:
PIN 1. GATE
2. SOURCE
3. DRAIN
4. SOURCE

STYLE 11:
PIN 1. DRAIN
2. SOURCE
3. GATE
4. SOURCE

STYLE 12:
PIN 1. MAIN TERMINAL 1
2. MAIN TERMINAL 2
3. GATE
4. NOT CONNECTED

DOCUMENT NUMBER:	98ASB42148B	Electronic versions are uncontrolled except when accessed directly from the Document Repository. Printed versions are uncontrolled except when stamped "CONTROLLED COPY" in red.
DESCRIPTION:	TO-220	PAGE 1 OF 1

onsemi and onsemi are trademarks of Semiconductor Components Industries, LLC dba onsemi or its subsidiaries in the United States and/or other countries. onsemi reserves the right to make changes without further notice to any products herein. onsemi makes no warranty, representation or guarantee regarding the suitability of its products for any particular purpose, nor does onsemi assume any liability arising out of the application or use of any product or circuit, and specifically disclaims any and all liability, including without limitation special, consequential or incidental damages. onsemi does not convey any license under its patent rights nor the rights of others.

onsemi, **Onsemi**, and other names, marks, and brands are registered and/or common law trademarks of Semiconductor Components Industries, LLC dba "**onsemi**" or its affiliates and/or subsidiaries in the United States and/or other countries. **onsemi** owns the rights to a number of patents, trademarks, copyrights, trade secrets, and other intellectual property. A listing of **onsemi**'s product/patent coverage may be accessed at www.onsemi.com/site/pdf/Patent-Marking.pdf. **onsemi** reserves the right to make changes at any time to any products or information herein, without notice. The information herein is provided "as-is" and **onsemi** makes no warranty, representation or guarantee regarding the accuracy of the information, product features, availability, functionality, or suitability of its products for any particular purpose, nor does **onsemi** assume any liability arising out of the application or use of any product or circuit, and specifically disclaims any and all liability, including without limitation special, consequential or incidental damages. Buyer is responsible for its products and applications using **onsemi** products, including compliance with all laws, regulations and safety requirements or standards, regardless of any support or applications information provided by **onsemi**. "Typical" parameters which may be provided in **onsemi** data sheets and/or specifications can and do vary in different applications and actual performance may vary over time. All operating parameters, including "Typicals" must be validated for each customer application by customer's technical experts. **onsemi** does not convey any license under any of its intellectual property rights nor the rights of others. **onsemi** products are not designed, intended, or authorized for use as a critical component in life support systems or any FDA Class 3 medical devices or medical devices with a same or similar classification in a foreign jurisdiction or any devices intended for implantation in the human body. Should Buyer purchase or use **onsemi** products for any such unintended or unauthorized application, Buyer shall indemnify and hold **onsemi** and its officers, employees, subsidiaries, affiliates, and distributors harmless against all claims, costs, damages, and expenses, and reasonable attorney fees arising out of, directly or indirectly, any claim of personal injury or death associated with such unintended or unauthorized use, even if such claim alleges that **onsemi** was negligent regarding the design or manufacture of the part. **onsemi** is an Equal Opportunity/Affirmative Action Employer. This literature is subject to all applicable copyright laws and is not for resale in any manner.

PUBLICATION ORDERING INFORMATION

LITERATURE FULFILLMENT:

Email Requests to: orderlit@onsemi.com

onsemi Website: www.onsemi.com

TECHNICAL SUPPORT

North American Technical Support:

Voice Mail: 1 800-282-9855 Toll Free USA/Canada

Phone: 011 421 33 790 2910

Europe, Middle East and Africa Technical Support:

Phone: 00421 33 790 2910

For additional information, please contact your local Sales Representative