

# Switch-mode Power Rectifier 100 V, 40 A

## MBR41H100CT, NRVBB41H100CT Series

### Features and Benefits

- Low Forward Voltage: 0.67 V @ 125°C
- Low Power Loss/High Efficiency
- High Surge Capacity
- 175°C Operating Junction Temperature
- 40 A Total (20 A Per Diode Leg)
- Guard-Ring for Stress Protection
- NRVBB Prefix for Automotive and Other Applications Requiring Unique Site and Control Change Requirements; AEC-Q101 Qualified and PPAP Capable
- These Devices are Pb-Free, Halogen Free/BFR Free and are RoHS Compliant
- MBR41H100CTH and MBRB41H100CT-1H are Halide-Free

### Applications

- Power Supply – Output Rectification
- Power Management
- Instrumentation

### Mechanical Characteristics:

- Case: Epoxy, Molded
- Epoxy Meets UL 94 V-0 @ 0.125 in
- Weight (Approximately): 1.9 Grams (TO-220)  
1.7 Grams (D<sup>2</sup>PAK-3)  
1.5 Grams (TO-262)
- Finish: All External Surfaces Corrosion Resistant and Terminal Leads are Readily Solderable
- Lead Temperature for Soldering Purposes:  
260°C Max. for 10 Seconds



ON Semiconductor®

[www.onsemi.com](http://www.onsemi.com)

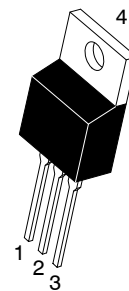
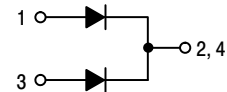

TO-220  
CASE 221A  
STYLE 6

### MARKING DIAGRAMS

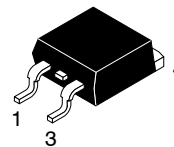
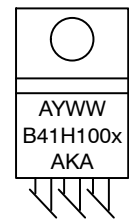

D<sup>2</sup>PAK-3  
CASE 418B  
STYLE 3

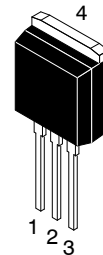
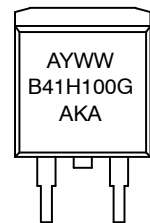

I<sup>2</sup>PAK (TO-262)  
CASE 418D  
STYLE 3

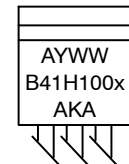

A = Assembly Location  
Y = Year  
WW = Work Week  
x = G or H  
G = Pb-Free Package  
H = Halide-Free Package  
AKA = Polarity Designator

### ORDERING INFORMATION

See detailed ordering and shipping information in the package dimensions section on page 6 of this data sheet.

## MBR41H100CT, NRVBB41H100CT Series

### MAXIMUM RATINGS (Per Diode Leg)

Rating	Symbol	Value	Unit
Peak Repetitive Reverse Voltage Working Peak Reverse Voltage DC Blocking Voltage	$V_{RRM}$ $V_{RWM}$ $V_R$	100	V
Average Rectified Forward Current (Rated $V_R$ ) $T_C = 150^\circ\text{C}$	$I_{F(AV)}$	20	A
Peak Repetitive Forward Current (Rated $V_R$ , Square Wave, 20 kHz) $T_C = 145^\circ\text{C}$	$I_{FRM}$	40	A
Nonrepetitive Peak Surge Current (Surge applied at rated load conditions halfwave, single phase, 60 Hz)	$I_{FSM}$	350	A
Operating Junction Temperature (Note 1)	$T_J$	+175	$^\circ\text{C}$
Storage Temperature	$T_{stg}$	-65 to +175	$^\circ\text{C}$
Voltage Rate of Change (Rated $V_R$ )	dv/dt	10,000	V/ $\mu\text{s}$
Controlled Avalanche Energy (see test conditions in Figures 10 and 11)	$W_{AVAIL}$	400	mJ
ESD Ratings: Machine Model = C Human Body Model = 3B		> 400 > 8000	V

Stresses exceeding those listed in the Maximum Ratings table may damage the device. If any of these limits are exceeded, device functionality should not be assumed, damage may occur and reliability may be affected.

1. The heat generated must be less than the thermal conductivity from Junction-to-Ambient:  $dP_D/dT_J < 1/R_{\theta JA}$ .

### THERMAL CHARACTERISTICS (Per Diode Leg)

Characteristic	Symbol	Value	Unit
Maximum Thermal Resistance Junction-to-Case Junction-to-Ambient	$R_{\theta JC}$ $R_{\theta JA}$	2.0 70	$^\circ\text{C}/\text{W}$

### ELECTRICAL CHARACTERISTICS (Per Diode Leg)

Characteristic	Symbol	Value	Unit
Maximum Instantaneous Forward Voltage (Note 2) ( $I_F = 20\text{ A}$ , $T_C = 25^\circ\text{C}$ ) ( $I_F = 20\text{ A}$ , $T_C = 125^\circ\text{C}$ ) ( $I_F = 40\text{ A}$ , $T_C = 25^\circ\text{C}$ ) ( $I_F = 40\text{ A}$ , $T_C = 125^\circ\text{C}$ )	$V_F$	0.80 0.67 0.90 0.76	V
Maximum Instantaneous Reverse Current (Note 2) (Rated DC Voltage, $T_C = 125^\circ\text{C}$ ) (Rated DC Voltage, $T_C = 25^\circ\text{C}$ )	$i_R$	10 0.01	mA

Product parametric performance is indicated in the Electrical Characteristics for the listed test conditions, unless otherwise noted. Product performance may not be indicated by the Electrical Characteristics if operated under different conditions.

2. Pulse Test: Pulse Width = 300  $\mu\text{s}$ , Duty Cycle  $\leq 2.0\%$ .

# MBR41H100CT, NRVBB41H100CT Series

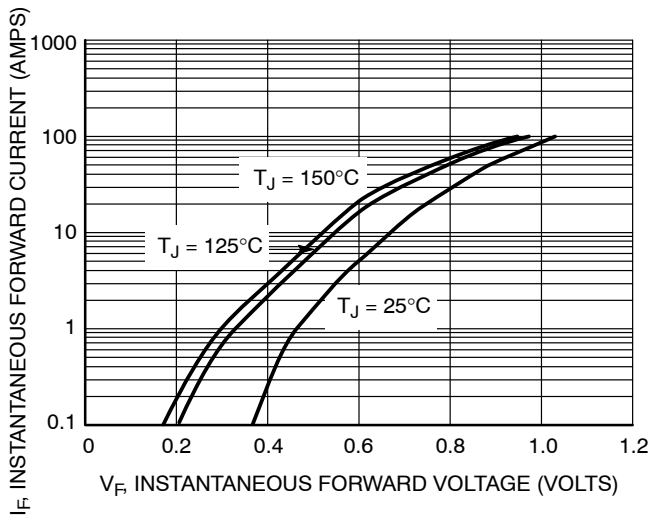

Figure 1. Typical Forward Voltage

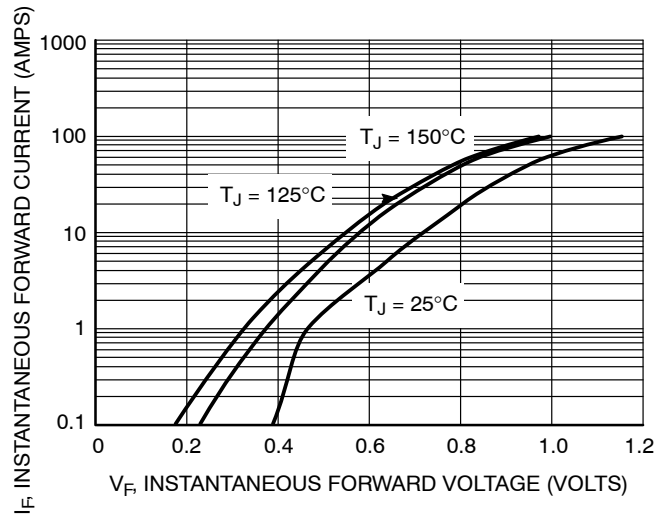

Figure 2. Maximum Forward Voltage

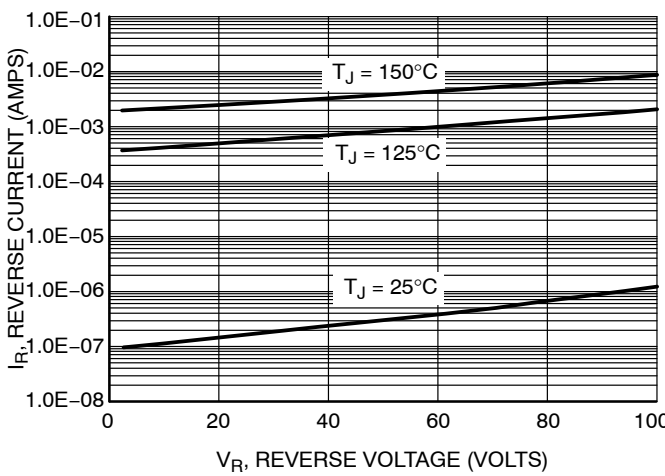

Figure 3. Typical Reverse Current

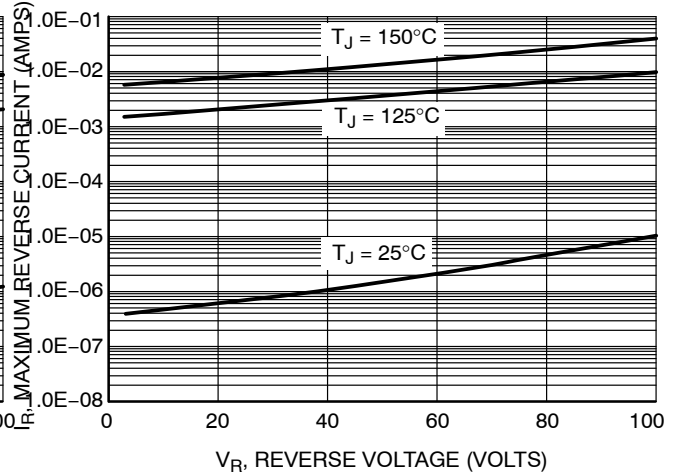

Figure 4. Maximum Reverse Current

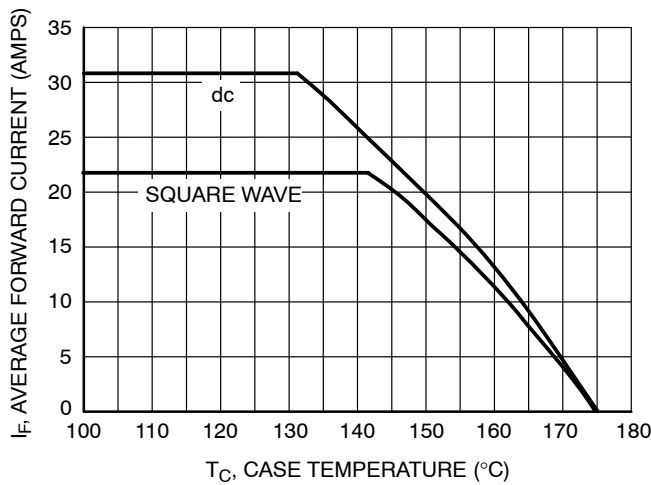

Figure 5. Current Derating

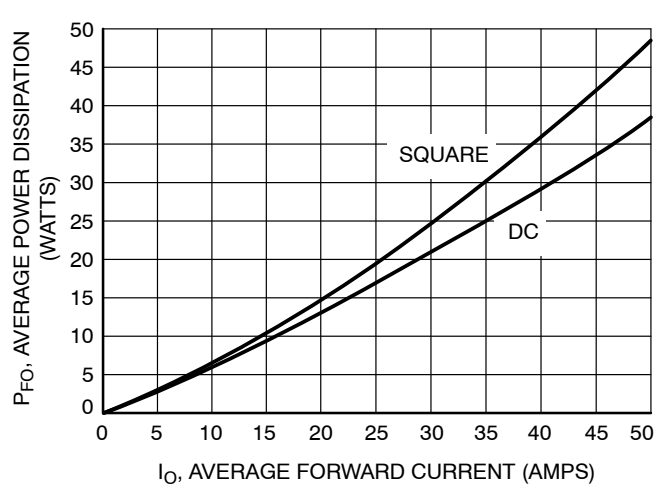

Figure 6. Forward Power Dissipation

# MBR41H100CT, NRVBB41H100CT Series

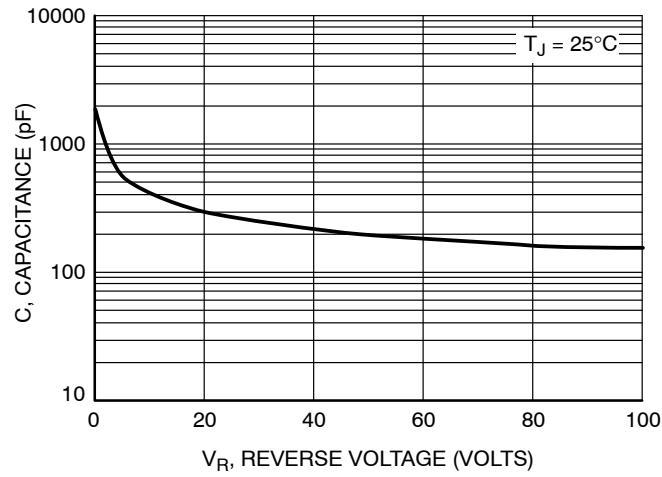

Figure 7. Capacitance

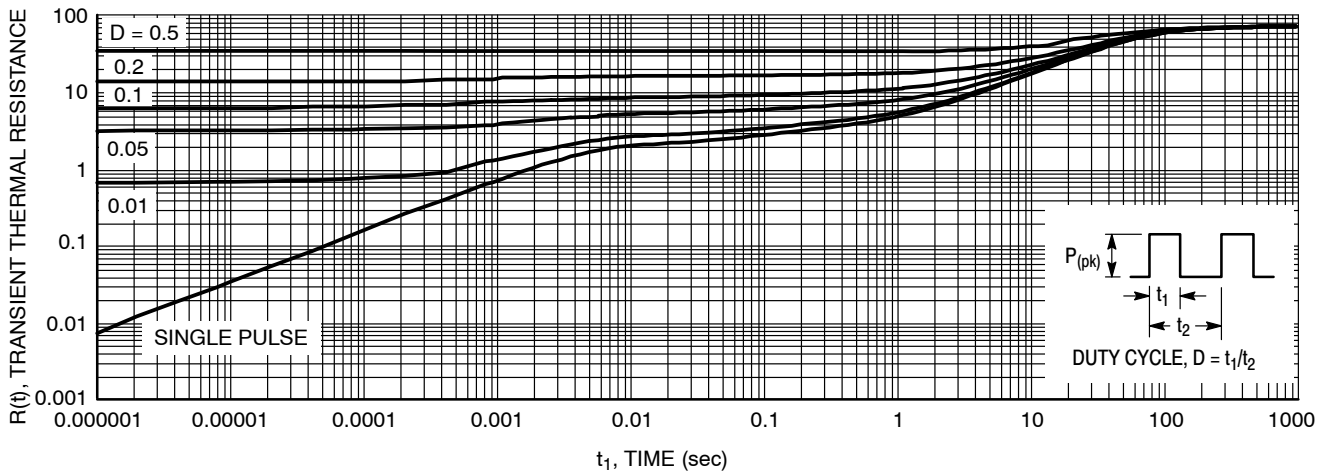

Figure 8. Thermal Response Junction-to-Ambient

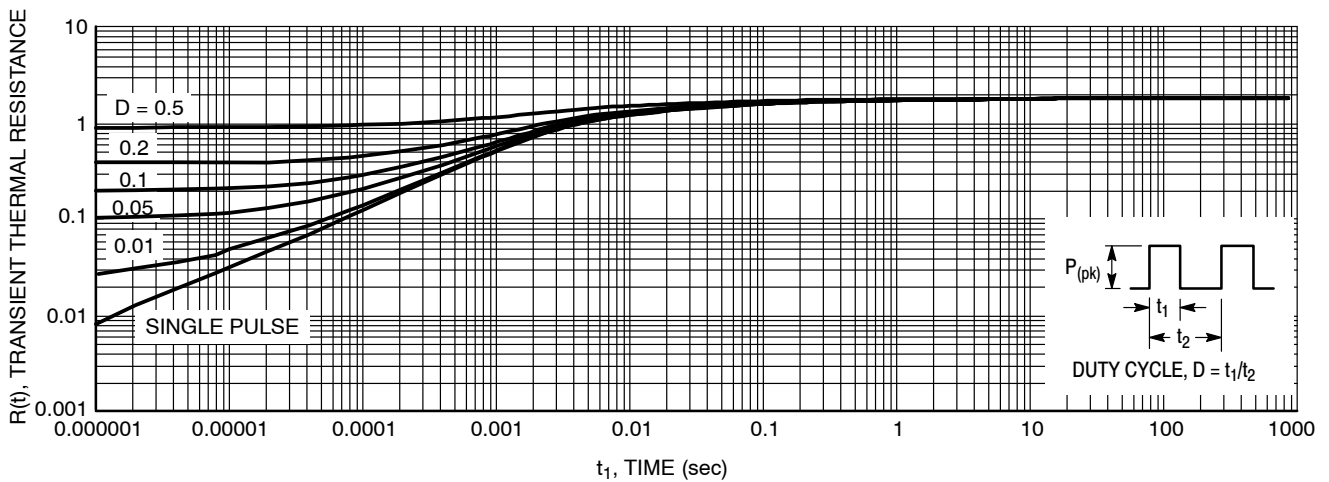

Figure 9. Thermal Response Junction-to-Case

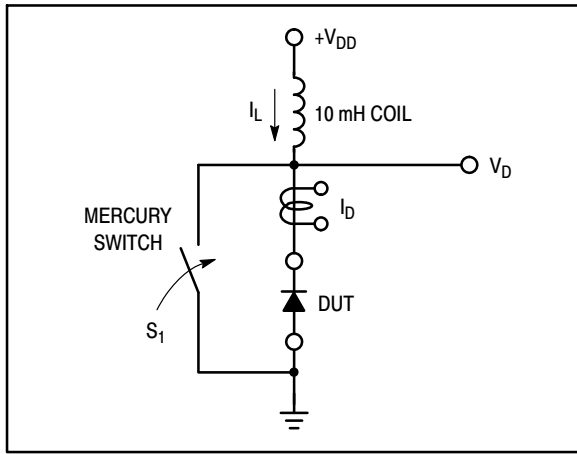

Figure 10. Test Circuit

The unclamped inductive switching circuit shown in Figure 10 was used to demonstrate the controlled avalanche capability of this device. A mercury switch was used instead of an electronic switch to simulate a noisy environment when the switch was being opened.

When  $S_1$  is closed at  $t_0$  the current in the inductor  $I_L$  ramps up linearly; and energy is stored in the coil. At  $t_1$  the switch is opened and the voltage across the diode under test begins to rise rapidly, due to  $di/dt$  effects, when this induced voltage reaches the breakdown voltage of the diode, it is clamped at  $BV_{DUT}$  and the diode begins to conduct the full load current which now starts to decay linearly through the diode, and goes to zero at  $t_2$ .

By solving the loop equation at the point in time when  $S_1$  is opened; and calculating the energy that is transferred to the diode it can be shown that the total energy transferred is equal to the energy stored in the inductor plus a finite amount of energy from the  $V_{DD}$  power supply while the diode is in breakdown (from  $t_1$  to  $t_2$ ) minus any losses due to finite component resistances. Assuming the component resistive

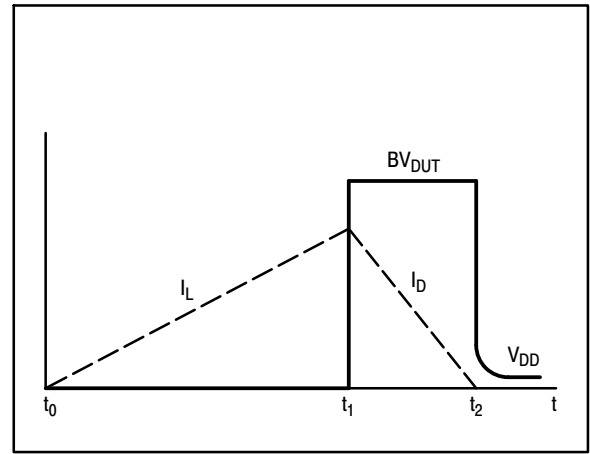

Figure 11. Current-Voltage Waveforms

elements are small Equation (1) approximates the total energy transferred to the diode. It can be seen from this equation that if the  $V_{DD}$  voltage is low compared to the breakdown voltage of the device, the amount of energy contributed by the supply during breakdown is small and the total energy can be assumed to be nearly equal to the energy stored in the coil during the time when  $S_1$  was closed, Equation (2).

EQUATION (1):

$$W_{AVAL} \approx \frac{1}{2} L I_{LPK}^2 \left( \frac{BV_{DUT}}{BV_{DUT} - V_{DD}} \right)$$

EQUATION (2):

$$W_{AVAL} \approx \frac{1}{2} L I_{LPK}^2$$

## MBR41H100CT, NRVBB41H100CT Series

### ORDERING INFORMATION

Device	Package	Shipping†
MBR41H100CTG	TO-220 (Pb-Free)	50 Units / Rail
MBR41H100CTH	TO-220 (Halide-Free)	50 Units / Rail
MBRB41H100CT-1G	I <sup>2</sup> PAK (Pb-Free)	50 Units / Rail
MBRB41H100CT-1H (In Development)	I <sup>2</sup> PAK (Halide-Free)	50 Units / Rail
MBRB41H100CTT4G	D <sup>2</sup> PAK 3 (Pb-Free)	800 Units / Tape & Reel
NRVBB41H100CTT4G*	D <sup>2</sup> PAK 3 (Pb-Free)	800 Units / Tape & Reel

†For information on tape and reel specifications, including part orientation and tape sizes, please refer to our Tape and Reel Packaging Specifications Brochure, BRD8011/D.

\*NRVBB Prefix for Automotive and Other Applications Requiring Unique Site and Control Change Requirements; AEC-Q100 Qualified and PPAP Capable.

# MECHANICAL CASE OUTLINE PACKAGE DIMENSIONS



## TO-220 CASE 221A ISSUE AK

DATE 13 JAN 2022



NOTES:

1. DIMENSIONING AND TOLERANCING PER ANSI Y14.5M, 2009.
2. CONTROLLING DIMENSION: INCHES
3. DIMENSION Z DEFINES A ZONE WHERE ALL BODY AND LEAD IRREGULARITIES ARE ALLOWED.
4. MAX WIDTH FOR F102 DEVICE = 1.35MM

DIM	INCHES		MILLIMETERS	
	MIN.	MAX.	MIN.	MAX.
A	0.570	0.620	14.48	15.75
B	0.380	0.415	9.66	10.53
C	0.160	0.190	4.07	4.83
D	0.025	0.038	0.64	0.96
F	0.142	0.161	3.60	4.09
G	0.095	0.105	2.42	2.66
H	0.110	0.161	2.80	4.10
J	0.014	0.024	0.36	0.61
K	0.500	0.562	12.70	14.27
L	0.045	0.060	1.15	1.52
N	0.190	0.210	4.83	5.33
Q	0.100	0.120	2.54	3.04
R	0.080	0.110	2.04	2.79
S	0.045	0.055	1.15	1.41
T	0.235	0.255	5.97	6.47
U	0.000	0.050	0.00	1.27
V	0.045	---	1.15	---
Z	---	0.080	---	2.04

STYLE 1:  
PIN 1. BASE  
2. COLLECTOR  
3. EMITTER  
4. COLLECTOR

STYLE 2:  
PIN 1. BASE  
2. EMITTER  
3. COLLECTOR  
4. EMITTER

STYLE 3:  
PIN 1. CATHODE  
2. ANODE  
3. GATE  
4. ANODE

STYLE 4:  
PIN 1. MAIN TERMINAL 1  
2. MAIN TERMINAL 2  
3. GATE  
4. MAIN TERMINAL 2

STYLE 5:  
PIN 1. GATE  
2. DRAIN  
3. SOURCE  
4. DRAIN

STYLE 6:  
PIN 1. ANODE  
2. CATHODE  
3. ANODE  
4. CATHODE

STYLE 7:  
PIN 1. CATHODE  
2. ANODE  
3. CATHODE  
4. ANODE

STYLE 8:  
PIN 1. CATHODE  
2. ANODE  
3. EXTERNAL TRIP/DELAY  
4. ANODE

STYLE 9:  
PIN 1. GATE  
2. COLLECTOR  
3. EMITTER  
4. COLLECTOR

STYLE 10:  
PIN 1. GATE  
2. SOURCE  
3. DRAIN  
4. SOURCE

STYLE 11:  
PIN 1. DRAIN  
2. SOURCE  
3. GATE  
4. SOURCE

STYLE 12:  
PIN 1. MAIN TERMINAL 1  
2. MAIN TERMINAL 2  
3. GATE  
4. NOT CONNECTED

DOCUMENT NUMBER:	98ASB42148B	Electronic versions are uncontrolled except when accessed directly from the Document Repository. Printed versions are uncontrolled except when stamped "CONTROLLED COPY" in red.
DESCRIPTION:	TO-220	PAGE 1 OF 1

onsemi and onsemi are trademarks of Semiconductor Components Industries, LLC dba onsemi or its subsidiaries in the United States and/or other countries. onsemi reserves the right to make changes without further notice to any products herein. onsemi makes no warranty, representation or guarantee regarding the suitability of its products for any particular purpose, nor does onsemi assume any liability arising out of the application or use of any product or circuit, and specifically disclaims any and all liability, including without limitation special, consequential or incidental damages. onsemi does not convey any license under its patent rights nor the rights of others.

# MECHANICAL CASE OUTLINE

## PACKAGE DIMENSIONS

ON Semiconductor®

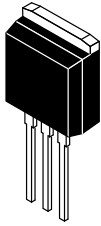

SCALE 1:1

I<sup>2</sup>PAK (TO-262)  
CASE 418D-01  
ISSUE D

DATE 16 OCT 2007

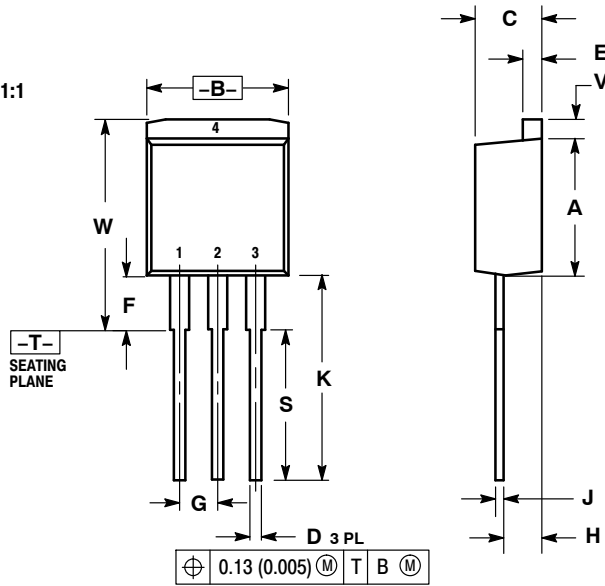

- NOTES:
1. DIMENSIONING AND TOLERANCING PER ANSI Y14.5M, 1982.
  2. CONTROLLING DIMENSION: INCH.

DIM	INCHES		MILLIMETERS	
	MIN	MAX	MIN	MAX
A	0.335	0.380	8.51	9.65
B	0.380	0.406	9.65	10.31
C	0.160	0.185	4.06	4.70
D	0.026	0.035	0.66	0.89
E	0.045	0.055	1.14	1.40
F	0.122 REF		3.10 REF	
G	0.100 BSC		2.54 BSC	
H	0.094	0.110	2.39	2.79
J	0.013	0.025	0.33	0.64
K	0.500	0.562	12.70	14.27
S	0.390 REF		9.90 REF	
V	0.045	0.070	1.14	1.78
W	0.522	0.551	13.25	14.00

STYLE 1:

- PIN 1. BASE
2. COLLECTOR
3. EMITTER
4. COLLECTOR

STYLE 2:

- PIN 1. GATE
2. DRAIN
3. SOURCE
4. DRAIN

STYLE 3:

- PIN 1. ANODE
2. CATHODE
3. ANODE
4. CATHODE

STYLE 4:

- PIN 1. GATE
2. COLLECTOR
3. EMITTER
4. COLLECTOR

<b>DOCUMENT NUMBER:</b>	<b>98ASB16716C</b>	Electronic versions are uncontrolled except when accessed directly from the Document Repository. Printed versions are uncontrolled except when stamped "CONTROLLED COPY" in red.
<b>DESCRIPTION:</b>	<b>I<sup>2</sup>PAK (TO-262)</b>	<b>PAGE 1 OF 1</b>

ON Semiconductor and are trademarks of Semiconductor Components Industries, LLC dba ON Semiconductor or its subsidiaries in the United States and/or other countries. ON Semiconductor reserves the right to make changes without further notice to any products herein. ON Semiconductor makes no warranty, representation or guarantee regarding the suitability of its products for any particular purpose, nor does ON Semiconductor assume any liability arising out of the application or use of any product or circuit, and specifically disclaims any and all liability, including without limitation special, consequential or incidental damages. ON Semiconductor does not convey any license under its patent rights nor the rights of others.



# MECHANICAL CASE OUTLINE

## PACKAGE DIMENSIONS

ON Semiconductor®



**D<sup>2</sup>PAK 3**  
CASE 418B-04  
ISSUE L

DATE 17 FEB 2015

SCALE 1:1

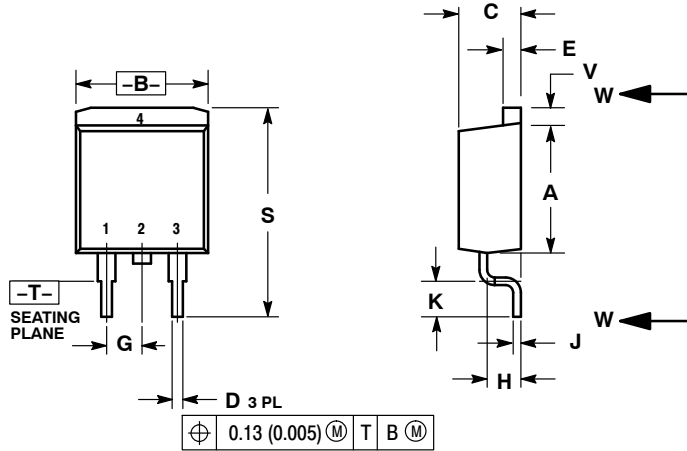

**NOTES:**

1. DIMENSIONING AND TOLERANCING PER ANSI Y14.5M, 1982.
2. CONTROLLING DIMENSION: INCH.
3. 418B-01 THRU 418B-03 OBSOLETE, NEW STANDARD 418B-04.

DIM	INCHES		MILLIMETERS	
	MIN	MAX	MIN	MAX
A	0.340	0.380	8.64	9.65
B	0.380	0.405	9.65	10.29
C	0.160	0.190	4.06	4.83
D	0.020	0.035	0.51	0.89
E	0.045	0.055	1.14	1.40
F	0.310	0.350	7.87	8.89
G	0.100	BSC	2.54	BSC
H	0.080	0.110	2.03	2.79
J	0.018	0.025	0.46	0.64
K	0.090	0.110	2.29	2.79
L	0.052	0.072	1.32	1.83
M	0.280	0.320	7.11	8.13
N	0.197	REF	5.00	REF
P	0.079	REF	2.00	REF
R	0.039	REF	0.99	REF
S	0.575	0.625	14.60	15.88
V	0.045	0.055	1.14	1.40

**VARIABLE CONFIGURATION ZONE**

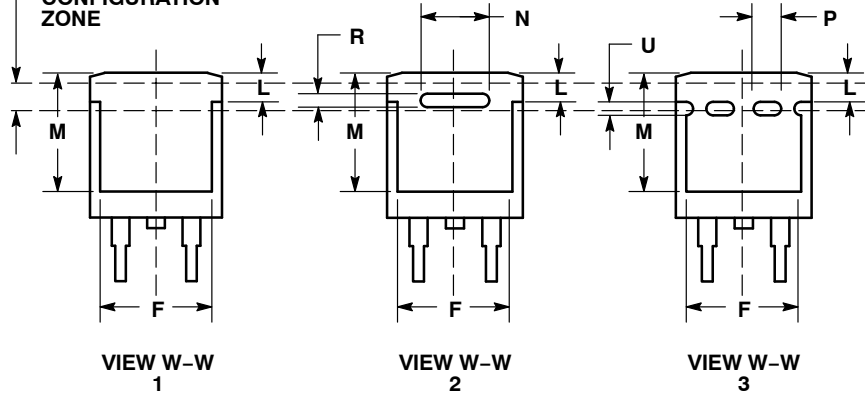

- |  |   |   |  |   |  |
|--|---|---|--|---|--|
| <b>STYLE 1:</b><br>PIN 1. BASE<br>2. COLLECTOR<br>3. EMITTER<br>4. COLLECTOR | <b>STYLE 2:</b><br>PIN 1. GATE<br>2. DRAIN<br>3. SOURCE<br>4. DRAIN | <b>STYLE 3:</b><br>PIN 1. ANODE<br>2. CATHODE<br>3. ANODE<br>4. CATHODE | <b>STYLE 4:</b><br>PIN 1. GATE<br>2. COLLECTOR<br>3. EMITTER<br>4. COLLECTOR | <b>STYLE 5:</b><br>PIN 1. CATHODE<br>2. ANODE<br>3. CATHODE<br>4. ANODE | <b>STYLE 6:</b><br>PIN 1. NO CONNECT<br>2. CATHODE<br>3. ANODE<br>4. CATHODE |
|--|---|---|--|---|--|

**MARKING INFORMATION AND FOOTPRINT ON PAGE 2**

<b>DOCUMENT NUMBER:</b>	<b>98ASB42761B</b>	Electronic versions are uncontrolled except when accessed directly from the Document Repository. Printed versions are uncontrolled except when stamped "CONTROLLED COPY" in red.
<b>DESCRIPTION:</b>	<b>D<sup>2</sup>PAK 3</b>	<b>PAGE 1 OF 2</b>

ON Semiconductor and are trademarks of Semiconductor Components Industries, LLC dba ON Semiconductor or its subsidiaries in the United States and/or other countries. ON Semiconductor reserves the right to make changes without further notice to any products herein. ON Semiconductor makes no warranty, representation or guarantee regarding the suitability of its products for any particular purpose, nor does ON Semiconductor assume any liability arising out of the application or use of any product or circuit, and specifically disclaims any and all liability, including without limitation special, consequential or incidental damages. ON Semiconductor does not convey any license under its patent rights nor the rights of others.

**D<sup>2</sup>PAK 3**  
CASE 418B-04  
ISSUE L

DATE 17 FEB 2015

**GENERIC  
MARKING DIAGRAM\***

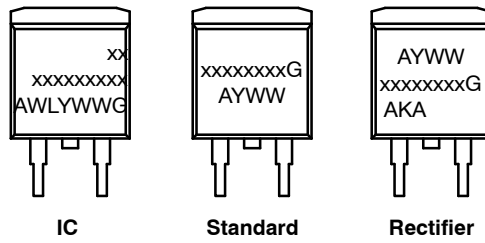

- xx = Specific Device Code
- A = Assembly Location
- WL = Wafer Lot
- Y = Year
- WW = Work Week
- G = Pb-Free Package
- AKA = Polarity Indicator

\*This information is generic. Please refer to device data sheet for actual part marking.  
Pb-Free indicator, "G" or microdot "▪", may or may not be present.

**SOLDERING FOOTPRINT\***

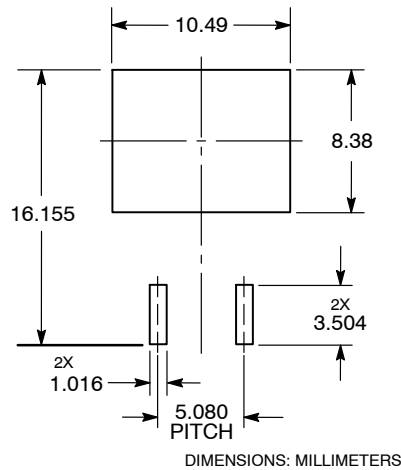

\*For additional information on our Pb-Free strategy and soldering details, please download the ON Semiconductor Soldering and Mounting Techniques Reference Manual, SOLDERRM/D.

<b>DOCUMENT NUMBER:</b>	<b>98ASB42761B</b>	Electronic versions are uncontrolled except when accessed directly from the Document Repository. Printed versions are uncontrolled except when stamped "CONTROLLED COPY" in red.
<b>DESCRIPTION:</b>	<b>D<sup>2</sup>PAK 3</b>	<b>PAGE 2 OF 2</b>

ON Semiconductor and  are trademarks of Semiconductor Components Industries, LLC dba ON Semiconductor or its subsidiaries in the United States and/or other countries. ON Semiconductor reserves the right to make changes without further notice to any products herein. ON Semiconductor makes no warranty, representation or guarantee regarding the suitability of its products for any particular purpose, nor does ON Semiconductor assume any liability arising out of the application or use of any product or circuit, and specifically disclaims any and all liability, including without limitation special, consequential or incidental damages. ON Semiconductor does not convey any license under its patent rights nor the rights of others.

**onsemi**, **Onsemi**, and other names, marks, and brands are registered and/or common law trademarks of Semiconductor Components Industries, LLC dba "**onsemi**" or its affiliates and/or subsidiaries in the United States and/or other countries. **onsemi** owns the rights to a number of patents, trademarks, copyrights, trade secrets, and other intellectual property. A listing of **onsemi**'s product/patent coverage may be accessed at [www.onsemi.com/site/pdf/Patent-Marking.pdf](http://www.onsemi.com/site/pdf/Patent-Marking.pdf). **onsemi** reserves the right to make changes at any time to any products or information herein, without notice. The information herein is provided "as-is" and **onsemi** makes no warranty, representation or guarantee regarding the accuracy of the information, product features, availability, functionality, or suitability of its products for any particular purpose, nor does **onsemi** assume any liability arising out of the application or use of any product or circuit, and specifically disclaims any and all liability, including without limitation special, consequential or incidental damages. Buyer is responsible for its products and applications using **onsemi** products, including compliance with all laws, regulations and safety requirements or standards, regardless of any support or applications information provided by **onsemi**. "Typical" parameters which may be provided in **onsemi** data sheets and/or specifications can and do vary in different applications and actual performance may vary over time. All operating parameters, including "Typicals" must be validated for each customer application by customer's technical experts. **onsemi** does not convey any license under any of its intellectual property rights nor the rights of others. **onsemi** products are not designed, intended, or authorized for use as a critical component in life support systems or any FDA Class 3 medical devices or medical devices with a same or similar classification in a foreign jurisdiction or any devices intended for implantation in the human body. Should Buyer purchase or use **onsemi** products for any such unintended or unauthorized application, Buyer shall indemnify and hold **onsemi** and its officers, employees, subsidiaries, affiliates, and distributors harmless against all claims, costs, damages, and expenses, and reasonable attorney fees arising out of, directly or indirectly, any claim of personal injury or death associated with such unintended or unauthorized use, even if such claim alleges that **onsemi** was negligent regarding the design or manufacture of the part. **onsemi** is an Equal Opportunity/Affirmative Action Employer. This literature is subject to all applicable copyright laws and is not for resale in any manner.

## PUBLICATION ORDERING INFORMATION

### LITERATURE FULFILLMENT:

Email Requests to: [orderlit@onsemi.com](mailto:orderlit@onsemi.com)

**onsemi Website:** [www.onsemi.com](http://www.onsemi.com)

### TECHNICAL SUPPORT

**North American Technical Support:**

Voice Mail: 1 800-282-9855 Toll Free USA/Canada

Phone: 011 421 33 790 2910

**Europe, Middle East and Africa Technical Support:**

Phone: 00421 33 790 2910

For additional information, please contact your local Sales Representative