

Ultrafast Dual Diode

12 A, 200 V

RURD620CCS9A

The RURD620CCS9A is an ultrafast dual diode with low forward voltage drop. This device is intended for use as freewheeling and clamping diodes in a variety of switching power supplies and other power switching applications. It is specially suited for use in switching power supplies and industrial application.

Features

- Ultrafast Recovery $t_{rr} = 30 \text{ ns}$ (@ $I_F = 6 \text{ A}$)
- Max Forward Voltage, $V_F = 1.0 \text{ V}$ (@ $T_C = 25^\circ\text{C}$)
- Reverse Voltage, $V_{RRM} = 200 \text{ V}$
- Avalanche Energy Rated
- RoHS Compliant

Applications

- Switching Power Supplies
- Power Switching Circuits
- General Purpose

ABSOLUTE MAXIMUM RATINGS (Per Leg)

($T_C = 25^\circ\text{C}$ unless otherwise specified)

Symbol	Rating	Value	Unit
V_{RRM}	Peak Repetitive Reverse Voltage	200	V
V_{RWM}	Working Peak Reverse Voltage	200	V
V_R	DC Blocking Voltage	200	V
$I_{F(AV)}$	Average Rectified Forward Current $T_C = 160^\circ\text{C}$	6	A
I_{FRM}	Repetitive Peak Surge Current Square Wave, 20 kHz	12	A
I_{FSM}	Nonrepetitive Peak Surge Current Halfwave, 1 Phase, 60 Hz	60	A
P_D	Maximum Power Dissipation	45	W
E_{AVL}	Avalanche Energy (See Figures 10 and 11)	10	mJ
T_{STG}, T_J	Operating and Storage Temperature	-65 to 175	$^\circ\text{C}$

Stresses exceeding those listed in the Maximum Ratings table may damage the device. If any of these limits are exceeded, device functionality should not be assumed, damage may occur and reliability may be affected.

SYMBOL

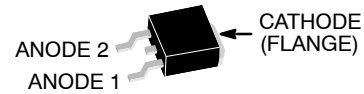
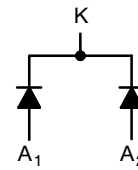

DPAK3 (TO-252 3 LD)
JEDEC
CASE 369AS

MARKING DIAGRAM

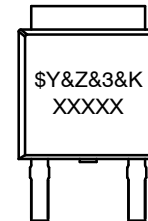

- \$Y = onsemi Logo
- &Z = Assembly Plant Code
- &3 = 3-Digit Date Code
- &K = 2-Digits Lot Run Traceability Code
- XXXXX = Device Code (UR620C, RURD620)

ORDERING INFORMATION

Part Number	Package	Brand
RURD620CCS9A	TO-252-3L	UR620C
RURD620CCS9A-F085	TO-252-3L	RURD620

NOTE: When ordering, use the entire part number. Add the suffix, 9 A, to obtain the TO-252 variant in tape and reel, i.e., RURD620CCS9A.

RURD620CCS9A

ELECTRICAL CHARACTERISTICS (Per Leg) ($T_C = 25^\circ\text{C}$ unless otherwise specified)

Symbol	Test Condition	Min	Typ	Max	Unit
V_F	$I_F = 6\text{ A}$	-	-	1.0	V
	$I_F = 6\text{ A}, T_C = 150^\circ\text{C}$	-	-	0.83	V
I_R	$V_R = 200\text{ V}$	-	-	100	μA
	$V_R = 200\text{ V}, T_C = 150^\circ\text{C}$	-	-	500	μA
t_{rr}	$I_F = 1\text{ A}, dI_F/dt = 200\text{ A}/\mu\text{s}$	-	-	25	ns
	$I_F = 6\text{ A}, dI_F/dt = 200\text{ A}/\mu\text{s}$	-	-	30	ns
t_a	$I_F = 6\text{ A}, dI_F/dt = 200\text{ A}/\mu\text{s}$	-	13	-	ns
t_b	$I_F = 6\text{ A}, dI_F/dt = 200\text{ A}/\mu\text{s}$	-	6.5	-	ns
Q_{rr}	$I_F = 6\text{ A}, dI_F/dt = 200\text{ A}/\mu\text{s}$	-	20	-	nC
C_J	$V_R = 10\text{ V}, I_F = 0\text{ A}$	-	30	-	pF
$R_{\theta JC}$		-	-	3.5	$^\circ\text{C}/\text{W}$

Product parametric performance is indicated in the Electrical Characteristics for the listed test conditions, unless otherwise noted. Product performance may not be indicated by the Electrical Characteristics if operated under different conditions.

DEFINITIONS

V_F = Instantaneous forward voltage (pw = 300 μs , D = 2%).

I_R = Instantaneous reverse current.

T_{rr} = Reverse recovery time (See Figure 9), summation of $t_a + t_b$.

t_a = Time to reach peak reverse current (See Figure 9).

t_b = Time from peak I_{RM} to projected zero crossing of I_{RM} based on a straight line from peak I_{RM} through 25% of I_{RM} (See Figure 9).

Q_{rr} = Reverse recovery charge.

C_J = Junction Capacitance.

$R_{\theta JC}$ = Thermal resistance junction to case. pw = Pulse width.

D = Duty cycle.

TYPICAL PERFORMANCE CURVES

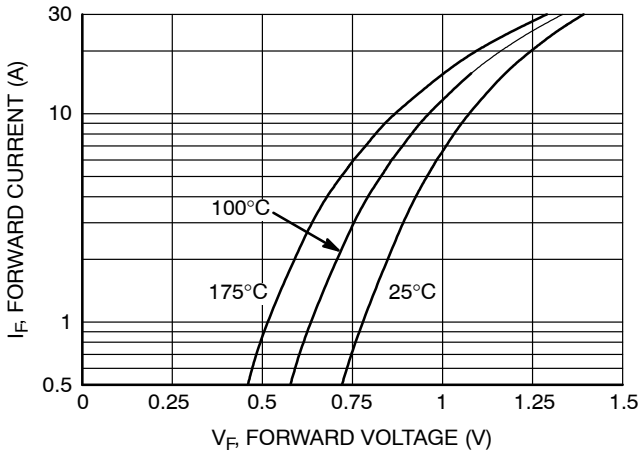

Figure 1. Forward Current vs. Forward Voltage

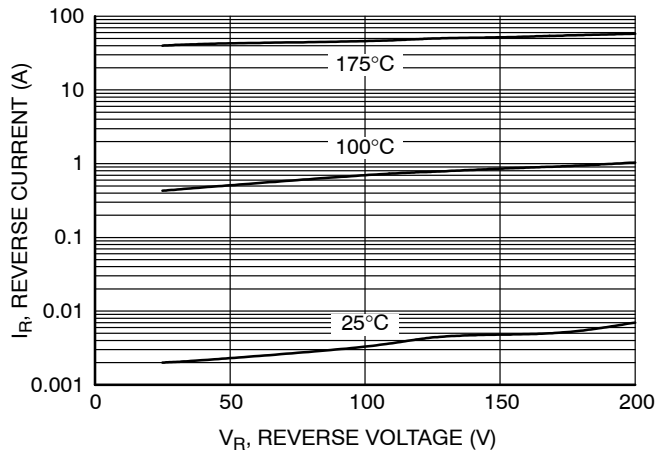

Figure 2. Reverse Current vs. Reverse Voltage

TYPICAL PERFORMANCE CURVES (Continued)

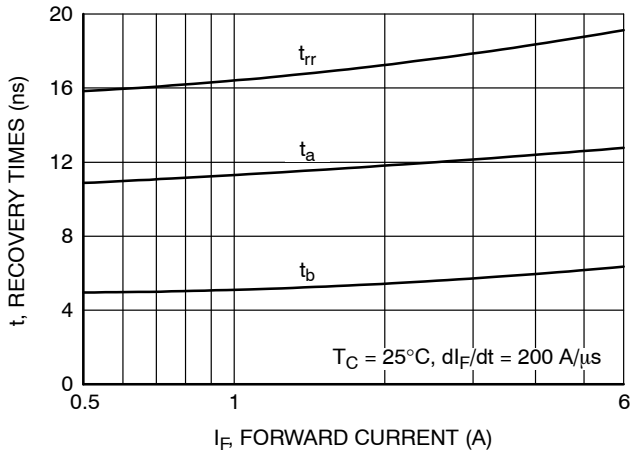

Figure 3. t_{rr} , t_a and t_b Curves vs. Forward Current

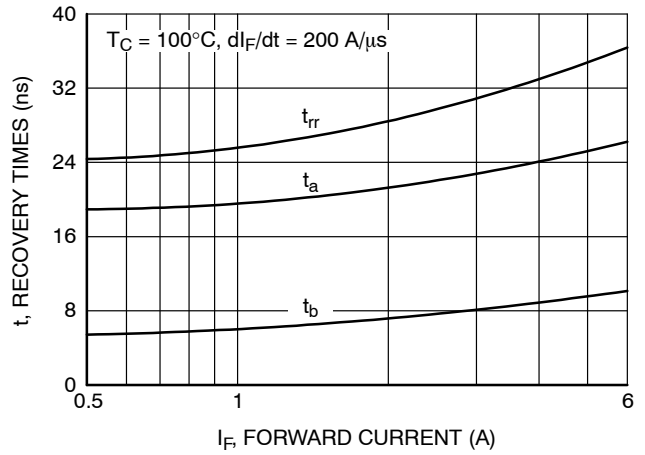

Figure 4. t_{rr} , t_a and t_b Curves vs. Forward Current

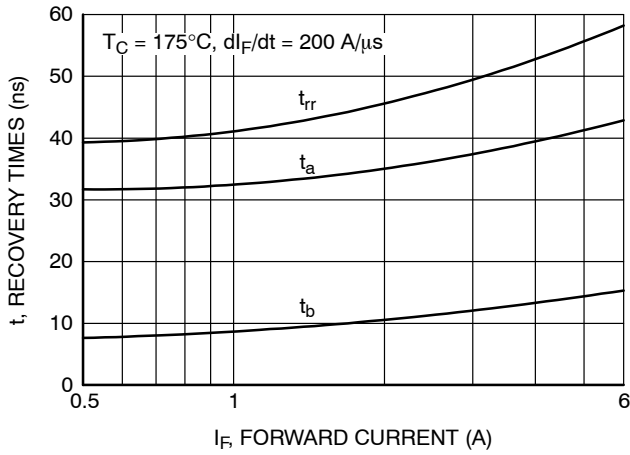

Figure 5. t_{rr} , t_a and t_b Curves vs. Forward Current

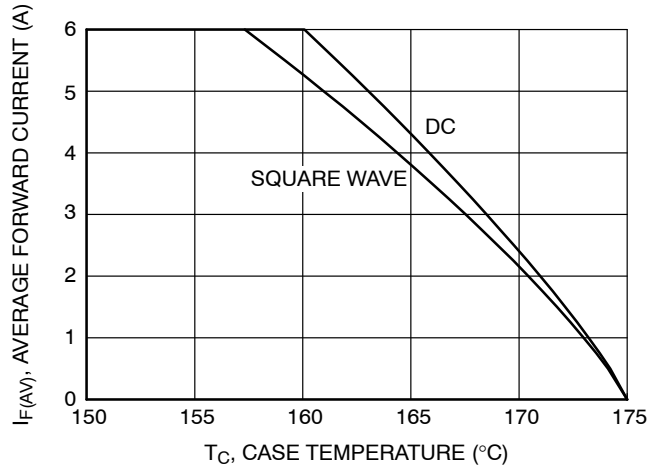

Figure 6. Current Derating Curve

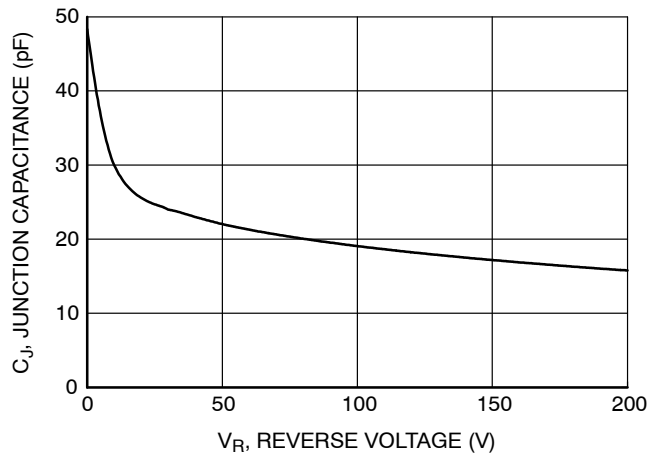

Figure 7. Junction Temperature vs. Reverse Voltage

TEST CIRCUITS AND WAVEFORMS

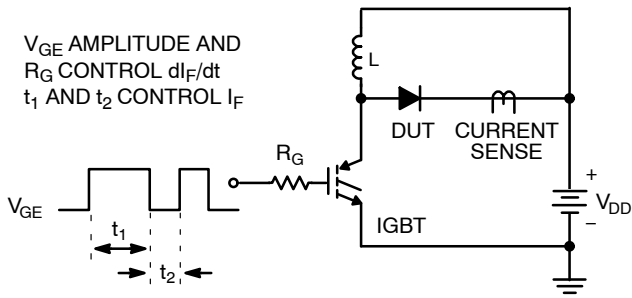

Figure 8. t_{rr} Test Circuit

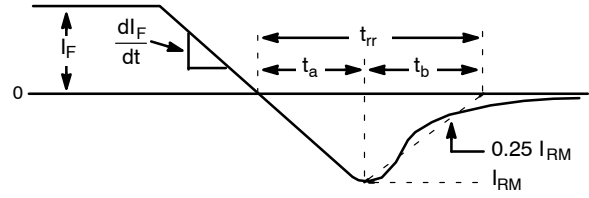

Figure 9. t_{rr} Waveforms and Definitions

$I = 1 \text{ A}$
 $L = 20 \text{ mH}$
 $R < 0.1 \Omega$
 $E_{AVL} = 1/2LI^2 [V_{R(AVL)} / (V_{R(AVL)} - V_{DD})]$
 $Q_1 = \text{IGBT (} BV_{CES} > \text{DUT } V_{R(AVL)} \text{)}$

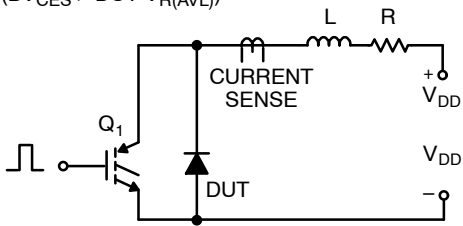

Figure 10. Avalanche Energy Test Circuit

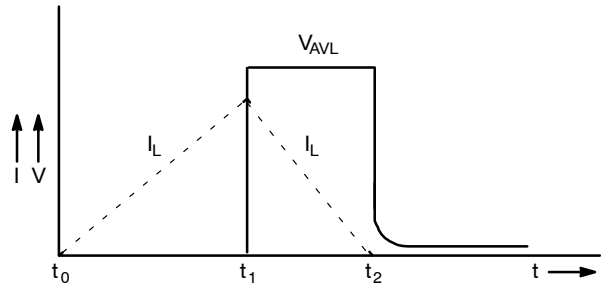

Figure 11. Avalanche Current and Voltage Waveforms

MECHANICAL CASE OUTLINE PACKAGE DIMENSIONS



DPAK3 (TO-252 3 LD) CASE 369AS ISSUE A

DATE 28 SEP 2022



- NOTES: UNLESS OTHERWISE SPECIFIED
 A) THIS PACKAGE CONFORMS TO JEDEC, TO-252, ISSUE C, VARIATION AA.
 B) ALL DIMENSIONS ARE IN MILLIMETERS.
 C) DIMENSIONING AND TOLERANCING PER ASME Y14.5M-2009.
 D) SUPPLIER DEPENDENT MOLD LOCKING HOLES OR CHAMFERED CORNERS OR EDGE PROTRUSION.
 E) FOR DIODE PRODUCTS, L4 IS 0.25 MM MAX.
 F) DIMENSIONS ARE EXCLUSIVE OF BURRS, MOLD FLASH AND TIE BAR EXTRUSIONS.
 G) LAND PATTERN RECOMMENDATION IS BASED ON IPC7351A STD TO228P991X239-3N.

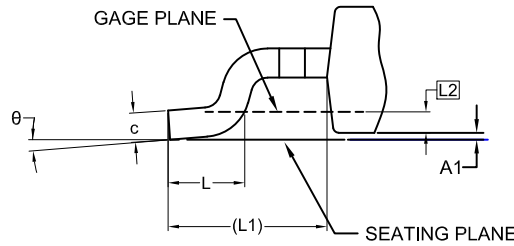

DETAIL A
(ROTATED -90°)
SCALE: 12X

DIM	MILLIMETERS		
	MIN.	NOM.	MAX.
A	2.18	2.29	2.39
A1	0.00	-	0.127
b	0.64	0.77	0.89
b2	0.76	0.95	1.14
b3	5.21	5.34	5.46
c	0.45	0.53	0.61
c2	0.45	0.52	0.58
D	5.97	6.10	6.22
D1	5.21	-	-
E	6.35	6.54	6.73
E1	4.32	-	-
e	2.286 BSC		
e1	4.572 BSC		
H	9.40	9.91	10.41
L	1.40	1.59	1.78
L1	2.90 REF		
L2	0.51 BSC		
L3	0.89	1.08	1.27
L4	-	-	1.02
θ	0°	--	10°

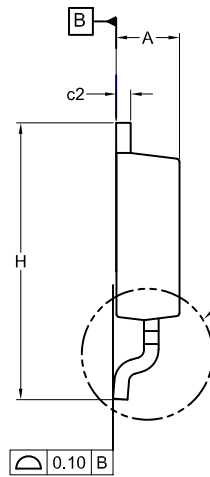
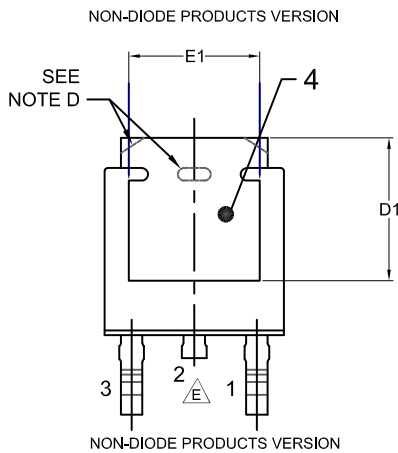

GENERIC MARKING DIAGRAM*



- XXXX = Specific Device Code
- A = Assembly Location
- Y = Year
- WW = Work Week
- ZZ = Assembly Lot Code

*This information is generic. Please refer to device data sheet for actual part marking. Pb-free indicator, "G" or microdot "•", may or may not be present. Some products may not follow the Generic Marking.

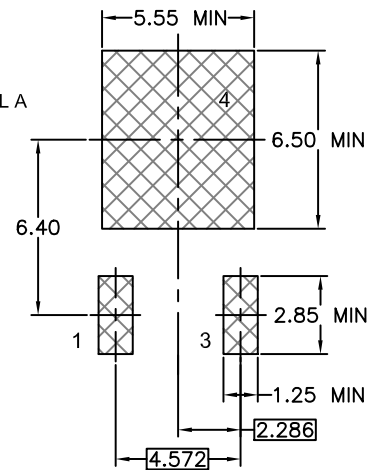

LAND PATTERN RECOMMENDATION

*FOR ADDITIONAL INFORMATION ON OUR PB-FREE STRATEGY AND SOLDERING DETAILS, PLEASE DOWNLOAD THE ON SEMICONDUCTOR SOLDERING AND MOUNTING TECHNIQUES REFERENCE MANUAL, SOLDERRM/D.

DOCUMENT NUMBER:	98AON13810G	Electronic versions are uncontrolled except when accessed directly from the Document Repository. Printed versions are uncontrolled except when stamped "CONTROLLED COPY" in red.
DESCRIPTION:	DPAK3 (TO-252 3 LD)	PAGE 1 OF 1

onsemi and ONSEMI are trademarks of Semiconductor Components Industries, LLC dba onsemi or its subsidiaries in the United States and/or other countries. onsemi reserves the right to make changes without further notice to any products herein. onsemi makes no warranty, representation or guarantee regarding the suitability of its products for any particular purpose, nor does onsemi assume any liability arising out of the application or use of any product or circuit, and specifically disclaims any and all liability, including without limitation special, consequential or incidental damages. onsemi does not convey any license under its patent rights nor the rights of others.

onsemi, **Onsemi**, and other names, marks, and brands are registered and/or common law trademarks of Semiconductor Components Industries, LLC dba "**onsemi**" or its affiliates and/or subsidiaries in the United States and/or other countries. **onsemi** owns the rights to a number of patents, trademarks, copyrights, trade secrets, and other intellectual property. A listing of **onsemi**'s product/patent coverage may be accessed at www.onsemi.com/site/pdf/Patent-Marking.pdf. **onsemi** reserves the right to make changes at any time to any products or information herein, without notice. The information herein is provided "as-is" and **onsemi** makes no warranty, representation or guarantee regarding the accuracy of the information, product features, availability, functionality, or suitability of its products for any particular purpose, nor does **onsemi** assume any liability arising out of the application or use of any product or circuit, and specifically disclaims any and all liability, including without limitation special, consequential or incidental damages. Buyer is responsible for its products and applications using **onsemi** products, including compliance with all laws, regulations and safety requirements or standards, regardless of any support or applications information provided by **onsemi**. "Typical" parameters which may be provided in **onsemi** data sheets and/or specifications can and do vary in different applications and actual performance may vary over time. All operating parameters, including "Typicals" must be validated for each customer application by customer's technical experts. **onsemi** does not convey any license under any of its intellectual property rights nor the rights of others. **onsemi** products are not designed, intended, or authorized for use as a critical component in life support systems or any FDA Class 3 medical devices or medical devices with a same or similar classification in a foreign jurisdiction or any devices intended for implantation in the human body. Should Buyer purchase or use **onsemi** products for any such unintended or unauthorized application, Buyer shall indemnify and hold **onsemi** and its officers, employees, subsidiaries, affiliates, and distributors harmless against all claims, costs, damages, and expenses, and reasonable attorney fees arising out of, directly or indirectly, any claim of personal injury or death associated with such unintended or unauthorized use, even if such claim alleges that **onsemi** was negligent regarding the design or manufacture of the part. **onsemi** is an Equal Opportunity/Affirmative Action Employer. This literature is subject to all applicable copyright laws and is not for resale in any manner.

PUBLICATION ORDERING INFORMATION

LITERATURE FULFILLMENT:

Email Requests to: orderlit@onsemi.com

onsemi Website: www.onsemi.com

TECHNICAL SUPPORT

North American Technical Support:
Voice Mail: 1 800-282-9855 Toll Free USA/Canada
Phone: 011 421 33 790 2910

Europe, Middle East and Africa Technical Support:

Phone: 00421 33 790 2910

For additional information, please contact your local Sales Representative