

MOSFET – N-Channel, Logic Level, **POWERTRENCH**[®]

60 V, 4 A, 60 mΩ

FDC5661N-F085

Features

- $R_{DS(on)} = 47\text{ m}\Omega$ at $V_{GS} = 10\text{ V}$, $I_D = 4.3\text{ A}$
- $R_{DS(on)} = 60\text{ m}\Omega$ at $V_{GS} = 4.5\text{ V}$, $I_D = 4\text{ A}$
- Typ $Q_g(TOT) = 14.5\text{ nC}$ at $V_{GS} = 10\text{ V}$
- Low Miller Charge
- UIS Capability
- AEC-Q101 Qualified and PPAP Capable
- This Device is Pb-Free, Halogen Free/BFR Free and is RoHS Compliant

Applications

- DC-DC Converter
- Motor Drives

MOSFET MAXIMUM RATINGS ($T_A = 25^\circ\text{C}$ unless otherwise noted)

Rating	Symbol	Value	Unit
Drain to Source Voltage	V_{DSS}	60	V
Gate to Source Voltage	V_{GS}	± 20	V
Drain Current Continuous ($V_{GS} = 10\text{ V}$)	I_D	4.3	A
Pulsed		20	
Single Pulse Avalanche Energy (Note 1)	E_{AS}	81	mJ
Power Dissipation	P_D	1.6	W
Operating and Storage Temperature	T_J, T_{STG}	-55 to +150	$^\circ\text{C}$
Thermal Resistance Junction to Case	$R_{\theta JC}$	30	$^\circ\text{C/W}$
Thermal Resistance Junction to Ambient TO-263, 1in ² Copper Pad Area	$R_{\theta JA}$	78	$^\circ\text{C/W}$

Stresses exceeding those listed in the Maximum Ratings table may damage the device. If any of these limits are exceeded, device functionality should not be assumed, damage may occur and reliability may be affected.

1. E_{AS} of 81 mJ is 100% test at $L = 14\text{ mH}$, $I_{AS} = 3.4\text{ A}$, Starting $T_J = 25^\circ\text{C}$

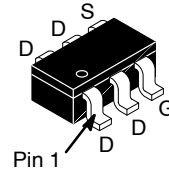

TSOT23-6
CASE 419BL

MARKING DIAGRAM

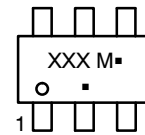

- XXX = Specific Device Code
- M = Date Code
- = Pb-Free Package

(Note: Microdot may be in either location)

PIN CONNECTIONS

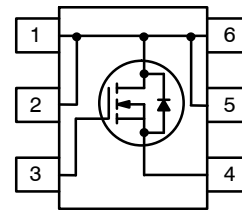

ORDERING INFORMATION

See detailed ordering and shipping information on page 5 of this data sheet.

FDC5661N-F085

ELECTRICAL CHARACTERISTICS ($T_A = 25^\circ\text{C}$ unless otherwise noted)

Parameter	Symbol	Test Condition	Min	Typ	Max	Unit
-----------	--------	----------------	-----	-----	-----	------

OFF CHARACTERISTICS

Drain to Source Breakdown Voltage	B_{VDSS}	$I_D = 250 \mu\text{A}, V_{GS} = 0 \text{ V}$	60	-	-	V
Zero Gate Voltage Drain Current	I_{DSS}	$V_{DS} = 48 \text{ V}, V_{GS} = 0 \text{ V}$	-	-	1	μA
			$T_A = 150^\circ\text{C}$	-	-	
Gate to Source Leakage Current	I_{GSS}	$V_{GS} = \pm 20 \text{ V}$	-	-	± 100	nA

ON CHARACTERISTICS

Gate to Source Threshold Voltage	$V_{GS(th)}$	$V_{GS} = V_{DS}, I_D = 250 \mu\text{A}$	1	2.0	3	V
Drain to Source On-Resistance	$R_{DS(on)}$	$V_{GS} = 10 \text{ V}, I_D = 4.3 \text{ A}$	-	38	47	$\text{m}\Omega$
		$V_{GS} = 4.5 \text{ V}, I_D = 4 \text{ A}$	-	46	60	
		$V_{GS} = 10 \text{ V}, I_D = 4.3 \text{ A}$	$T_J = 150^\circ\text{C}$	-	69	

DYNAMIC CHARACTERISTICS

Input Capacitance	C_{iss}	$V_{GS} = 0 \text{ V}, V_{DS} = 25 \text{ V},$ $f = 1 \text{ MHz}$	-	763	-	pF
Output Capacitance	C_{oss}		-	68	-	pF
Reverse Transfer Capacitance	C_{rss}		-	36	-	pF
Gate Resistance	R_G	$f = 1 \text{ MHz}$	-	2.6	-	Ω
Total Gate Charge at 10 V	$Q_{g(TOT)}$	$V_{GS} = 0 \text{ to } 10 \text{ V}, V_{DD} = 30 \text{ V}, I_D = 4.3 \text{ A}$	-	14.5	19	nC
Gate to Source Gate Charge	Q_{gs}	$V_{DD} = 30 \text{ V}, I_D = 4.3 \text{ A}$	-	2.4	-	nC
Gate to Drain "Miller" Charge	Q_{gd}		-	2.9	-	nC

SWITCHING CHARACTERISTICS

Turn-On Time	t_{on}	$V_{GS} = 10 \text{ V}, V_{DD} = 30 \text{ V},$ $I_D = 4.3 \text{ A}, R_{GS} = 6 \Omega,$	-	-	17.6	ns
Turn-On Delay Time	$t_{d(on)}$		-	7.2	-	ns
Rise Time	t_r		-	1.6	-	ns
Turn-Off Delay Time	$t_{d(off)}$		-	19.3	-	ns
Fall Time	t_f		-	3.1	-	ns
Turn-Off Time	t_{off}		-	-	36	ns

DRAIN-SOURCE DIODE CHARACTERISTICS

Source to Drain Diode Voltage	V_{SD}	$I_{SD} = 4.3 \text{ A}$	-	0.8	1.25	V
		$I_{SD} = 2.1 \text{ A}$	-	0.8	1.0	
Reverse Recovery Time	t_{rr}	$I_{SD} = 4.3 \text{ A}, dI_{SD}/dt = 100 \text{ A}/\mu\text{s}$	-	18.4	24	ns
Reverse Recovery Charge	Q_{rr}		-	10.0	13	nC

Product parametric performance is indicated in the Electrical Characteristics for the listed test conditions, unless otherwise noted. Product performance may not be indicated by the Electrical Characteristics if operated under different conditions.

TYPICAL CHARACTERISTICS

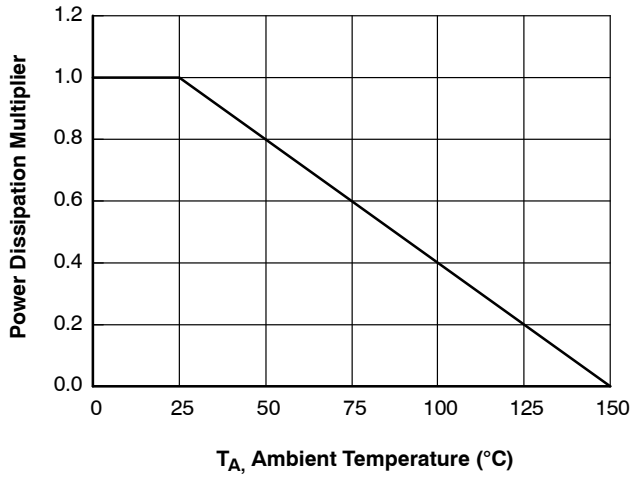

Figure 1. Normalized Power Dissipation vs. Ambient Temperature

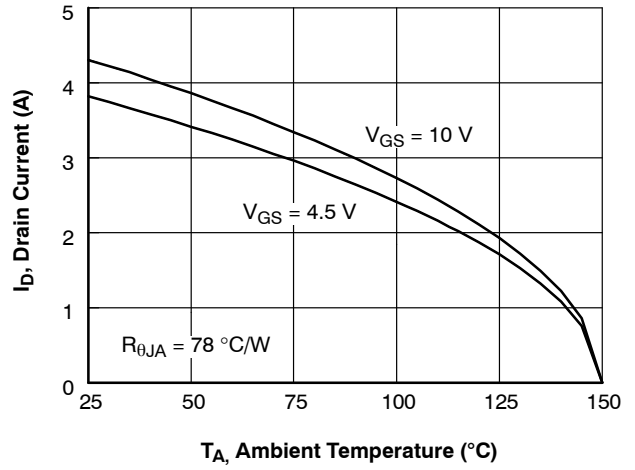

Figure 2. Maximum Continuous Drain Current vs. Ambient Temperature

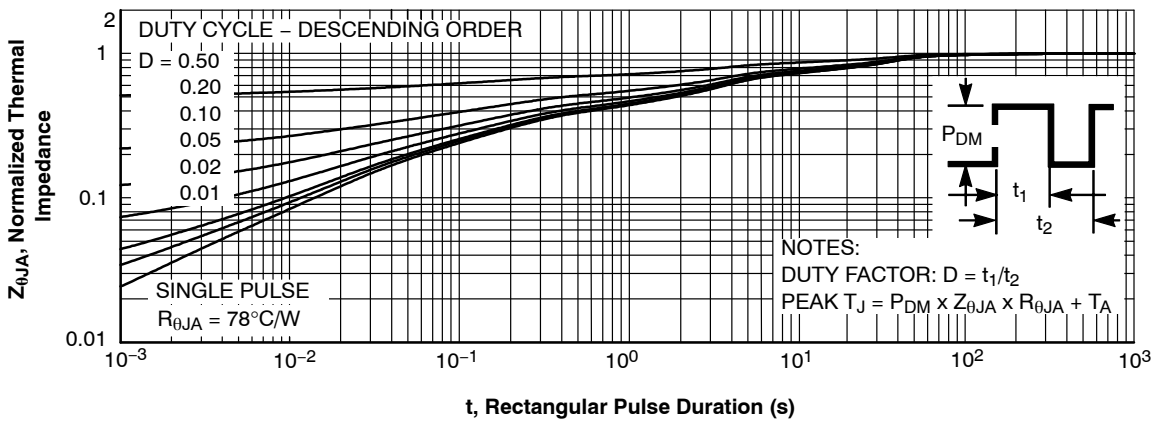

Figure 3. Normalized Maximum Transient Thermal Impedance

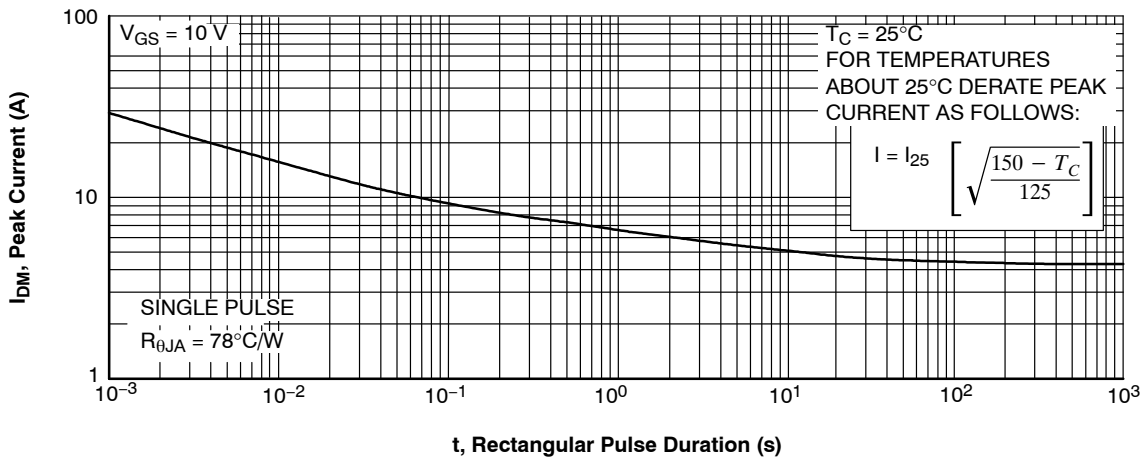

Figure 4. Peak Current Capability

TYPICAL CHARACTERISTICS (continued)

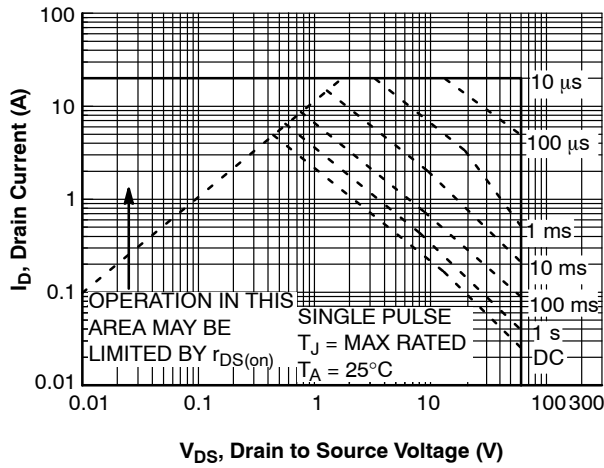

Figure 5. Forward Bias Safe Operating Area

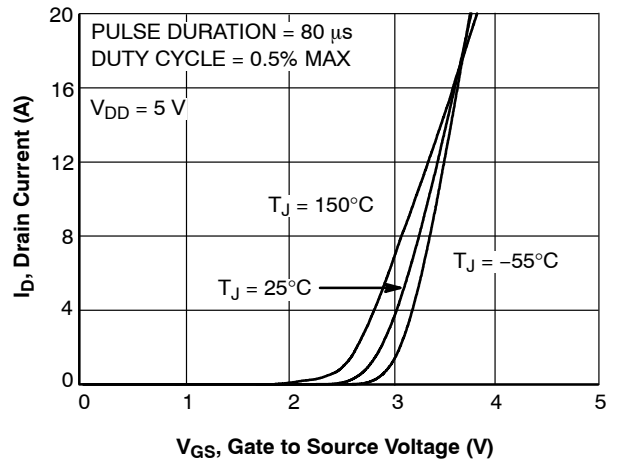

Figure 6. Transfer Characteristics

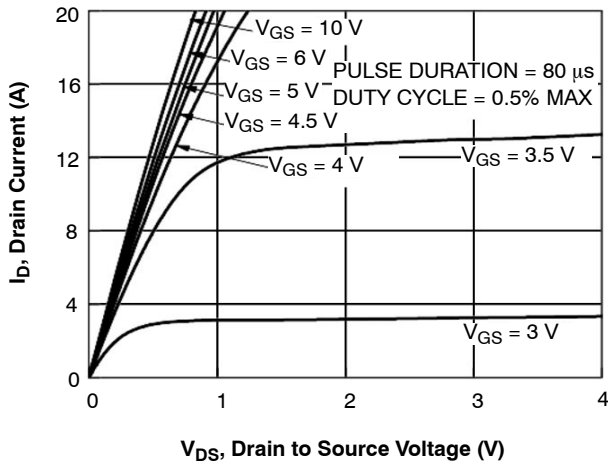

Figure 7. Saturation Characteristics

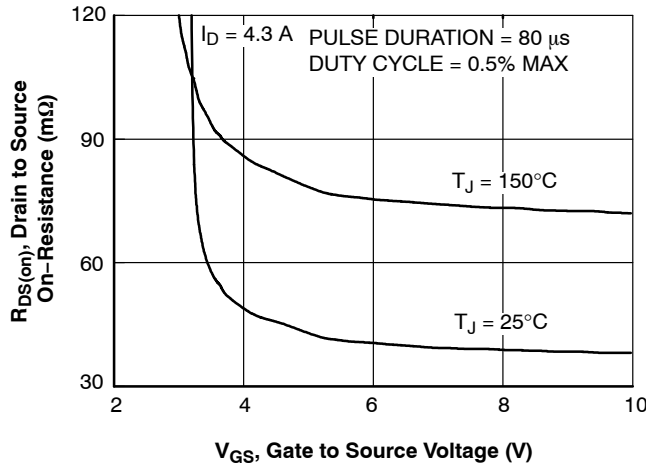

Figure 8. Drain to Source On-Resistance Variation vs. Gate to Source Voltage

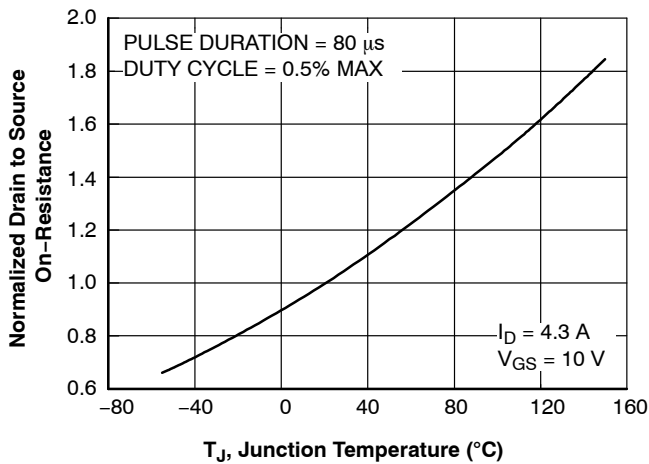

Figure 9. Normalized Drain to Source On Resistance vs. Junction Temperature

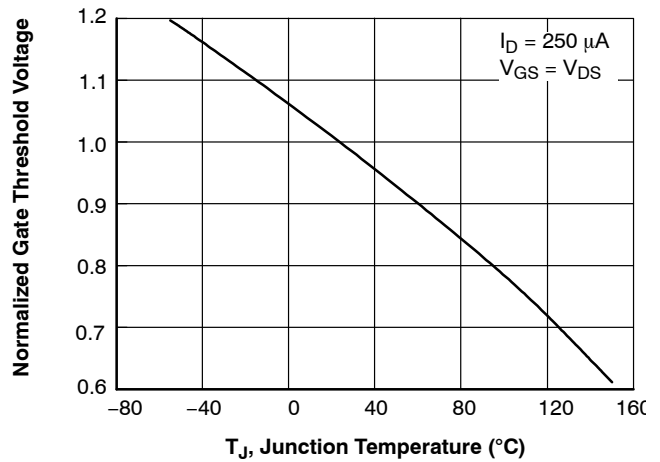

Figure 10. Normalized Gate Threshold Voltage vs. Junction Temperature

FDC5661N-F085

TYPICAL CHARACTERISTICS (continued)

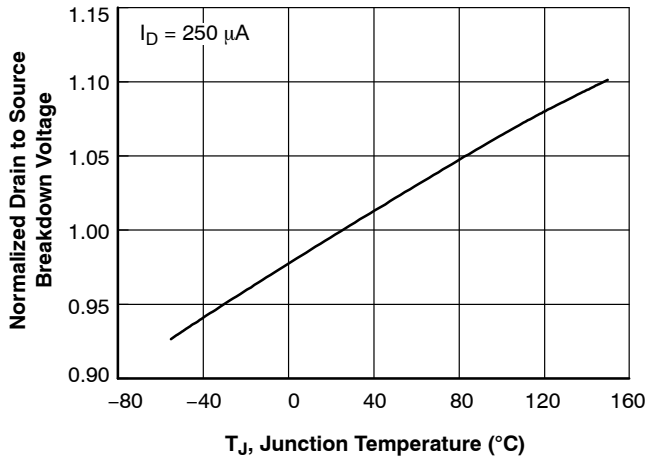

Figure 11. Normalized Drain to Source Breakdown Voltage vs. Junction Temperature

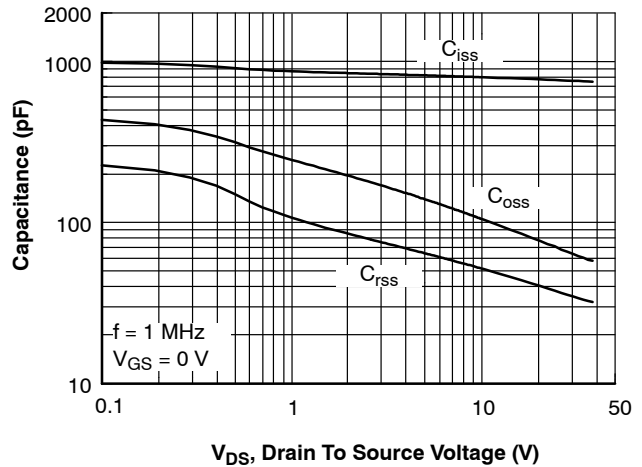

Figure 12. Capacitance vs. Drain to Source Voltage

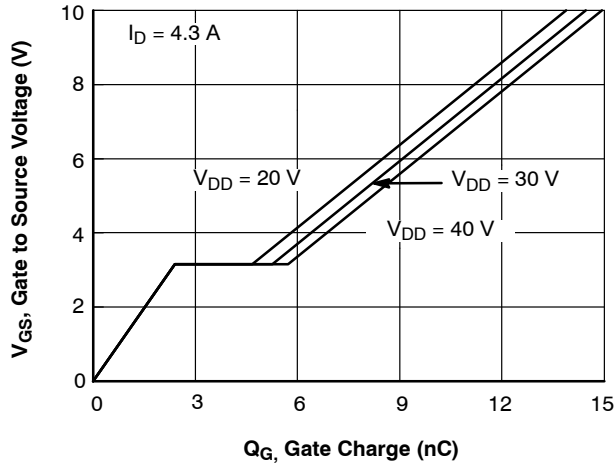

Figure 13. Gate Charge vs. Gate to Source Voltage

ORDERING INFORMATION

Device Marking	Device	Package	Shipping [†]
.661N	FDC5661N-F085	TSOT23-6 (Pb-Free)	3000 / Tape & Reel

[†]For information on tape and reel specifications, including part orientation and tape sizes, please refer to our Tape and Reel Packaging Specifications Brochure, [BRD8011/D](#).

POWERTRENCH is registered trademarks of Semiconductor Components Industries, LLC dba "onsemi" or its affiliates and/or subsidiaries in the United States and/or other countries.

MECHANICAL CASE OUTLINE

PACKAGE DIMENSIONS

ON Semiconductor®



SCALE 2:1

TSOT23 6-Lead CASE 419BL ISSUE A

DATE 31 AUG 2020

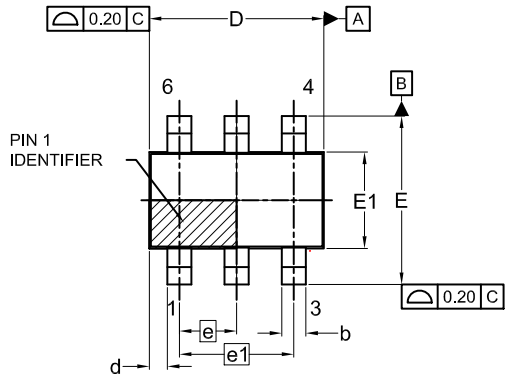

TOP VIEW

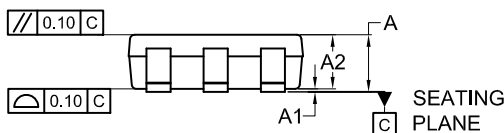

FRONT VIEW

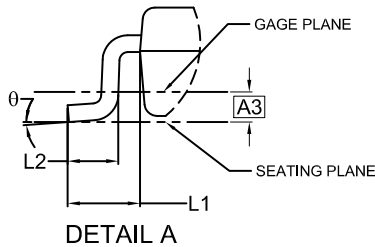

DETAIL A

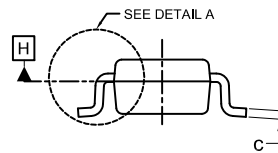

SIDE VIEW

SYMM

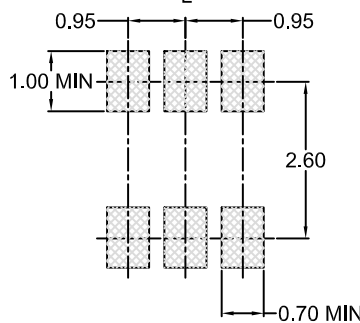

LAND PATTERN
RECOMMENDATION

*FOR ADDITIONAL INFORMATION ON OUR
Pb-FREE STRATEGY AND SOLDERING DETAILS,
PLEASE DOWNLOAD THE ON SEMICONDUCTOR
SOLDERING AND MOUNTING TECHNIQUES
REFERENCE MANUAL, SOLDERRM/D.

NOTES:

1. DIMENSIONING AND TOLERANCING PER ASME Y14.5M, 2009.
2. CONTROLLING DIMENSION: MILLIMETERS
3. DIMENSIONS D AND E1 DO NOT INCLUDE MOLD FLASH, PROTRUSIONS, OR GATE BURRS. MOLD FLASH, PROTRUSIONS OR GATE BURRS SHALL NOT EXCEED 0.25MM PER END. DIMENSIONS D AND E1 ARE DETERMINED AT DATUM H.
4. SEATING PLANE IS DEFINED BY THE TERMINALS. "A1" IS DEFINED AS THE DISTANCE FROM THE SEATING PLANE TO THE LOWEST POINT ON THE PACKAGE BODY.

DIM	MILLIMETERS		
	MIN.	NOM.	MAX.
A	0.90	1.00	1.10
A1	0.00	0.05	0.10
A2	0.70	0.85	1.00
A3	0.25 BSC		
b	0.25	0.38	0.50
c	0.10	0.18	0.26
D	2.80	2.95	3.10
d	0.30 REF		
E	2.50	2.75	3.00
E1	1.30	1.50	1.70
e	0.95 BSC		
e1	1.90 BSC		
L1	0.60 REF		
L2	0.20	0.40	0.60
Θ	0°	--	10°

GENERIC MARKING DIAGRAM*

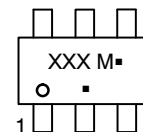

XXX = Specific Device Code
M = Date Code
▪ = Pb-Free Package

(Note: Microdot may be in either location)

*This information is generic. Please refer to device data sheet for actual part marking. Pb-Free indicator, "G" or microdot "▪", may or may not be present. Some products may not follow the Generic Marking.

DOCUMENT NUMBER:	98AON83292G	Electronic versions are uncontrolled except when accessed directly from the Document Repository. Printed versions are uncontrolled except when stamped "CONTROLLED COPY" in red.
DESCRIPTION:	TSOT23 6-Lead	PAGE 1 OF 1

ON Semiconductor and ON are trademarks of Semiconductor Components Industries, LLC dba ON Semiconductor or its subsidiaries in the United States and/or other countries. ON Semiconductor reserves the right to make changes without further notice to any products herein. ON Semiconductor makes no warranty, representation or guarantee regarding the suitability of its products for any particular purpose, nor does ON Semiconductor assume any liability arising out of the application or use of any product or circuit, and specifically disclaims any and all liability, including without limitation special, consequential or incidental damages. ON Semiconductor does not convey any license under its patent rights nor the rights of others.

onsemi, **Onsemi**, and other names, marks, and brands are registered and/or common law trademarks of Semiconductor Components Industries, LLC dba "**onsemi**" or its affiliates and/or subsidiaries in the United States and/or other countries. **onsemi** owns the rights to a number of patents, trademarks, copyrights, trade secrets, and other intellectual property. A listing of **onsemi**'s product/patent coverage may be accessed at www.onsemi.com/site/pdf/Patent-Marking.pdf. **onsemi** reserves the right to make changes at any time to any products or information herein, without notice. The information herein is provided "as-is" and **onsemi** makes no warranty, representation or guarantee regarding the accuracy of the information, product features, availability, functionality, or suitability of its products for any particular purpose, nor does **onsemi** assume any liability arising out of the application or use of any product or circuit, and specifically disclaims any and all liability, including without limitation special, consequential or incidental damages. Buyer is responsible for its products and applications using **onsemi** products, including compliance with all laws, regulations and safety requirements or standards, regardless of any support or applications information provided by **onsemi**. "Typical" parameters which may be provided in **onsemi** data sheets and/or specifications can and do vary in different applications and actual performance may vary over time. All operating parameters, including "Typicals" must be validated for each customer application by customer's technical experts. **onsemi** does not convey any license under any of its intellectual property rights nor the rights of others. **onsemi** products are not designed, intended, or authorized for use as a critical component in life support systems or any FDA Class 3 medical devices or medical devices with a same or similar classification in a foreign jurisdiction or any devices intended for implantation in the human body. Should Buyer purchase or use **onsemi** products for any such unintended or unauthorized application, Buyer shall indemnify and hold **onsemi** and its officers, employees, subsidiaries, affiliates, and distributors harmless against all claims, costs, damages, and expenses, and reasonable attorney fees arising out of, directly or indirectly, any claim of personal injury or death associated with such unintended or unauthorized use, even if such claim alleges that **onsemi** was negligent regarding the design or manufacture of the part. **onsemi** is an Equal Opportunity/Affirmative Action Employer. This literature is subject to all applicable copyright laws and is not for resale in any manner.

PUBLICATION ORDERING INFORMATION

LITERATURE FULFILLMENT:

Email Requests to: orderlit@onsemi.com

onsemi Website: www.onsemi.com

TECHNICAL SUPPORT

North American Technical Support:

Voice Mail: 1 800-282-9855 Toll Free USA/Canada

Phone: 011 421 33 790 2910

Europe, Middle East and Africa Technical Support:

Phone: 00421 33 790 2910

For additional information, please contact your local Sales Representative