

# 半桥栅极驱动器

## FAN7380

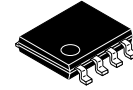

SOIC8  
(8-SOP)  
CASE 751EG

### 描述

FAN7380 是单片半桥栅极驱动 IC，可以驱动工作电压最高达 +600 V 的 MOSFET 和 IGBT。onsemi 的高压工艺和共模噪声消除技术可使高端驱动器在高  $dv/dt$  噪声环境下稳定运行。先进的电平转换电路，能使高端栅极驱动器的工作电压在  $V_{BS} = 15\text{ V}$  时高达  $V_S = -9.8\text{ V}$  (典型值)。输入逻辑电平与标准 TTL 系列逻辑栅极兼容。内部击穿保护电路提供 100 ns 死区时间以阻止输出开关器件在转换期间不被导通。当  $V_{CC}$  和  $V_{BS}$  小于指定阈值电压时，两个通道的欠压锁定 (UVLO) 电路可防止发生故障。输出驱动器的典型源电流 / 灌电流分别为 90 mA / 180 mA，适合荧光灯 / 紧凑型荧光灯应用和要求低  $di/dt$  噪声的系统。

### 特性

- 浮动通道专为高达 +600 V 的自举运行而设计
- 两个通道的源 / 灌电流驱动能力典型值为 90 mA / 180 mA
- 共模  $dv/dt$  噪声消除电路
- 在  $V_{CC} = V_{BS} = 15\text{ V}$  时信号传播过程中，扩展允许负  $V_S$  摆幅低达 -9.8 V
- $V_{CC}$  和  $V_{BS}$  供电范围从 10 V 至 20 V
- 双通道的欠压锁定功能
- 兼容 TTL 的输入逻辑阈值电平
- 匹配传播延迟低于 50 ns
- 内置 100 ns 死区时间控制功能
- 输出信号与输入信号同相位
- This is a Pb-Free Device

### 典型应用

- 荧光灯镇流器
- 紧凑型荧光灯镇流器

### 相关资源

- [AN-6076](#) – 高压栅极驱动 IC 自举电路的设计与应用指南
- [AN-9052](#) – 自举元件选择的设计指南
- [AN-8102](#) – 避免 HVIC 栅极驱动器应用中的短脉冲宽度问题的建议

### MARKING DIAGRAM

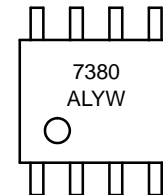

|      |                     |
|------|---------------------|
| 7380 | = Device Code       |
| A    | = Assembly Site     |
| L    | = Wafer Lot Number  |
| YW   | Assembly Start Week |

### ORDERING INFORMATION

See detailed ordering and shipping information on page 11 of this data sheet.

# FAN7380

## 典型应用电路



图 1. 荧光灯镇流器应用电路

## 内部框图

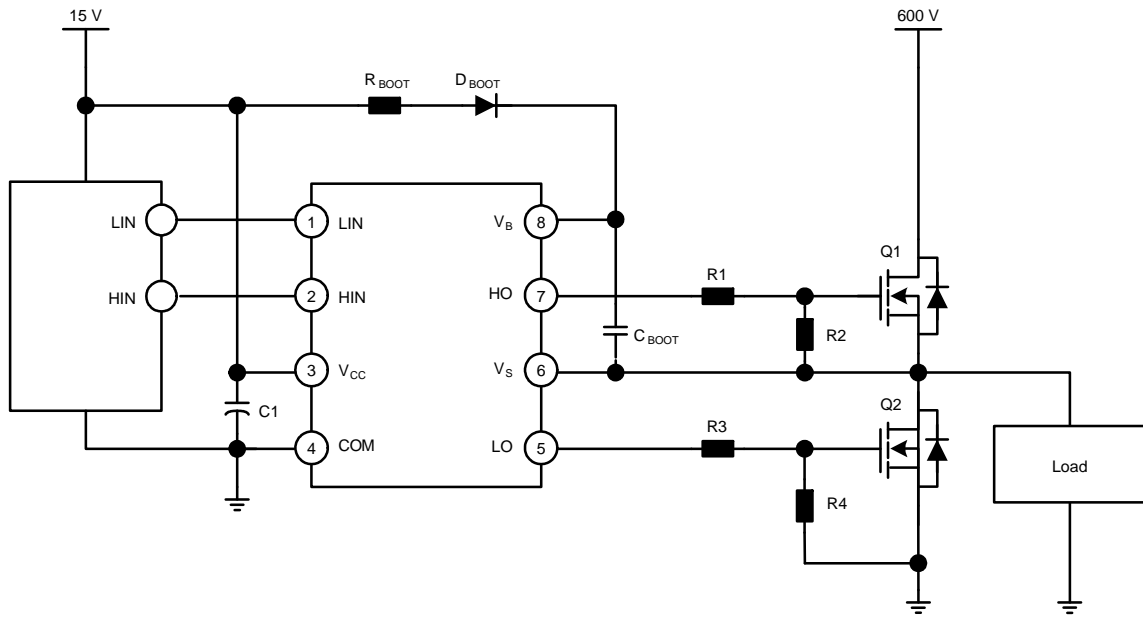

图 2. 功能框图

# FAN7380

## 引脚配置

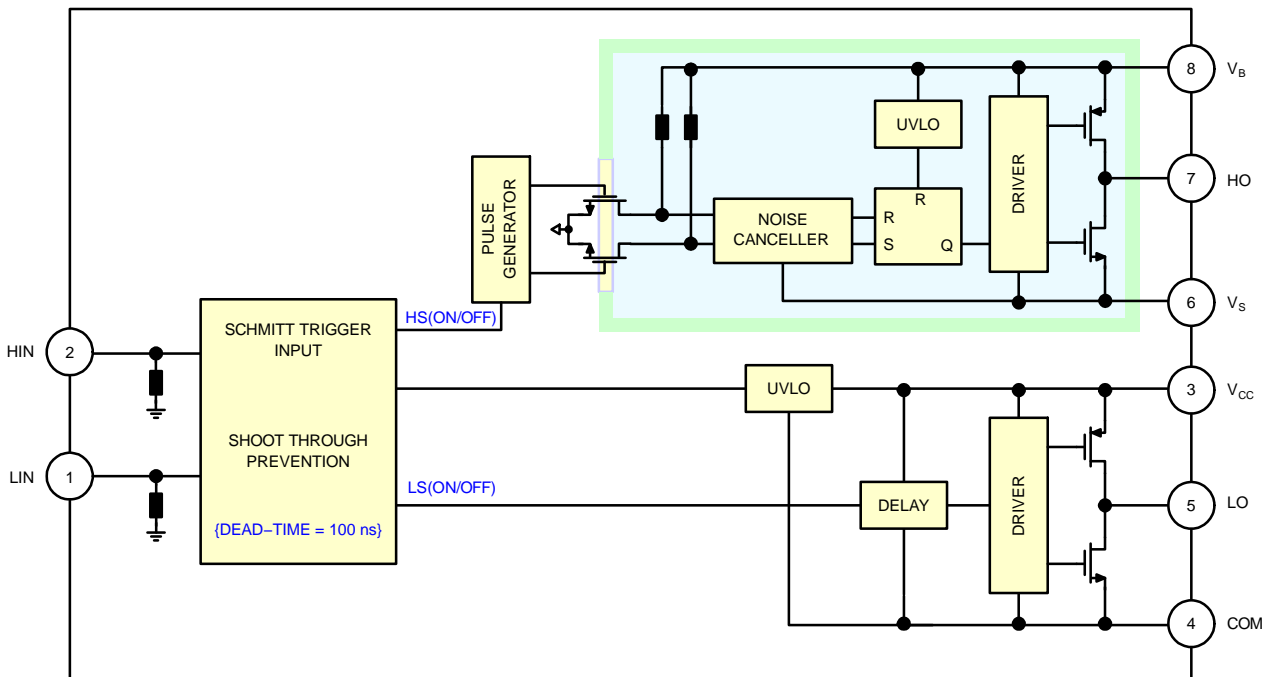

图 3. 引脚配置 (俯视图)

### 引脚定义

| 引脚号 | 名称              | I/O | 描述             |
|-----|-----------------|-----|----------------|
| 1   | LIN             | I   | 低侧栅极驱动器输出的逻辑输入 |
| 2   | HIN             | I   | 高侧栅极驱动器输出的逻辑输入 |
| 3   | V <sub>CC</sub> | I   | 低侧电源电压         |
| 4   | COM             |     | 逻辑地和低侧驱动器返回    |
| 5   | LO              | O   | 低侧栅极输出         |
| 6   | V <sub>S</sub>  | I   | 高侧浮动电源电压返回     |
| 7   | HO              | O   | 高侧驱动输出         |
| 8   | V <sub>B</sub>  | I   | 高侧浮动电源         |

# FAN7380

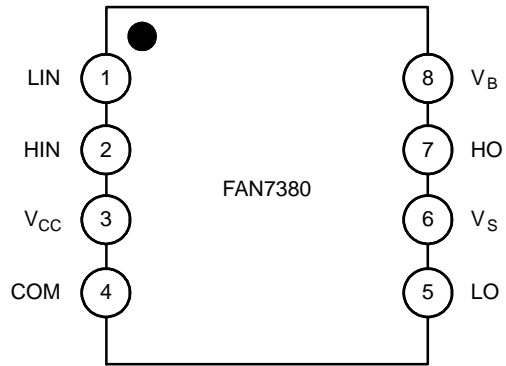
绝对最大额定值 (除非另有说明,  $T_A = 25^\circ\text{C}$ 。)

| 符号                    | 参数                | 最小值           | 最大值            | 单位                        |
|-----------------------|-------------------|---------------|----------------|---------------------------|
| $V_S$                 | 高侧偏置电压            | $V_B - 25$    | $V_B + 0.3$    | V                         |
| $V_B$                 | 高侧浮动电源电压          | -0.3          | 625.0          |                           |
| $V_{HO}$              | 高侧浮动输出电压 HO       | $V_S - 0.3$   | $V_B + 0.3$    |                           |
| $V_{CC}$              | 低侧和固定逻辑电源电压       | -0.3          | 25.0           |                           |
| $V_{LO}$              | 低侧输出电压 LO         | -0.3          | $V_{CC} + 0.3$ |                           |
| $V_{IN}$              | 逻辑输入电压 (HIN, LIN) | -0.3          | $V_{CC} + 0.3$ |                           |
| COM                   | 逻辑地               | $V_{CC} - 25$ | $V_{CC} + 0.3$ |                           |
| $dV_S/dt$             | 允许的偏置电压变化速率       | -             | 50             | V/ns                      |
| $P_D$<br>(注意 1, 2, 3) | 功耗                | -             | 0.625          | W                         |
| $\theta_{JA}$         | 结至环境热阻            | -             | 200            | $^\circ\text{C}/\text{W}$ |
| $T_J$                 | 结温                | -             | 150            | $^\circ\text{C}$          |
| $T_S$                 | 存储温度              | -50           | 150            | $^\circ\text{C}$          |

Stresses exceeding those listed in the Maximum Ratings table may damage the device. If any of these limits are exceeded, device functionality should not be assumed, damage may occur and reliability may be affected.

(参考译文)

如果电压超过最大额定值表中列出的值范围, 器件可能会损坏。如果超过任何这些限值, 将无法保证器件功能, 可能会导致器件损坏, 影响可靠性。

1. 安装在 76.2 x 114.3 x 1.6 mm PCB 板上 (FR-4 环氧玻璃材料)。

2. 参考以下标准:

JESD51-2: 集成电路热测试方法环境条件-自然对流

JESD51-3: 含铅表面贴装封装的低有效导热系数测试板

3. 在任何情况下, 都不要超过  $P_D$ 。

## 推荐工作额定值

| 符号       | 参数               | 最小值          | 最大值        | 单位               |
|----------|------------------|--------------|------------|------------------|
| $V_B$    | 高侧浮动电源电压         | $V_S + 10$   | $V_S + 20$ | V                |
| $V_S$    | 高侧浮动电源偏置电压       | $6 - V_{CC}$ | 600        |                  |
| $V_{HO}$ | 高侧 (HO) 输出电压     | $V_S$        | $V_B$      |                  |
| $V_{LO}$ | 低侧 (LO) 输出电压     | COM          | $V_{CC}$   |                  |
| $V_{IN}$ | 逻辑输入电压 (HIN、LIN) | COM          | $V_{CC}$   |                  |
| $V_{CC}$ | 低侧电源电压           | 10           | 20         |                  |
| $T_A$    | 环境温度             | -40          | 125        | $^\circ\text{C}$ |

Functional operation above the stresses listed in the Recommended Operating Ranges is not implied. Extended exposure to stresses beyond the Recommended Operating Ranges limits may affect device reliability.

(参考译文)

高于推荐工作范围表格中所列电压时, 不保证能够正常运行。长时间在推荐工作范围表格中规定范围以外的电压下运行, 可能会影响器件的可靠性。

# FAN7380

静态电气特性 (除非另有说明,  $V_{BIAS} (V_{CC}, V_{BS}) = 15.0\text{ V}$ 、 $T_A = 25^\circ\text{C}$ 。VIN 和 IIN 参数以 COM 为参考点。参数 VO 和 IO 以  $V_S$  和 COM 作为基准, 适用于相应的输出 HO 和 LO。)

| 符号                         | 参数                           | 工作条件   | 最小值 | 典型值  | 最大值  | 单位            |
|----------------------------|------------------------------|--|-----|------|------|---------------|
| $V_{CCUV+}$<br>$V_{BSUV+}$ | $V_{CC}$ 和 $V_{BS}$ 电源欠压正向阈值 |  | 8.2 | 9.2  | 10.0 | V             |
| $V_{CCUV-}$<br>$V_{BSUV-}$ | $V_{CC}$ 和 $V_{BS}$ 电源欠压负向阈值 |  | 7.6 | 8.7  | 9.6  |               |
| $V_{CCUVH}$<br>$V_{BSUVH}$ | $V_{CC}$ 电源欠压锁定滞回电压回差        |  | -   | 0.5  | -    |               |
| $I_{LK}$                   | 偏置电源漏电流                      | $V_B = V_S = 600\text{ V}$   | -   | -    | 50   | $\mu\text{A}$ |
| $I_{QBS}$                  | $V_{BS}$ 静态电源电流              | $V_{IN} = 0\text{ V or } 5\text{ V}$                                   | -   | 44   | 100  |               |
| $I_{QCC}$                  | $V_{CC}$ 静态电源电流              | $V_{IN} = 0\text{ V or } 5\text{ V}$                                   | -   | 70   | 180  |               |
| $I_{PBS}$                  | $V_{BS}$ 工作电源电流              | $f_{IN} = 20\text{ kHz, rms value}$                                    | -   | -    | 600  | $\mu\text{A}$ |
| $I_{PCC}$                  | $V_{CC}$ 工作电源电流              | $f_{IN} = 20\text{ kHz, rms value}$                                    | -   | -    | 610  |               |
| $V_{IH}$                   | 逻辑“1”输入电压                    |  | 2.5 | -    | -    | V             |
| $V_{IL}$                   | 逻辑“0”输入电压                    |  | -   | -    | 0.8  |               |
| $V_{OH}$                   | 高电平输出电压, $V_{BIAS}-V_O$      | $I_O = 20\text{ mA}$   | -   | -    | 2.8  | V             |
| $V_{OL}$                   | 低电平输出电压, $V_O$               |  | -   | -    | 1.2  |               |
| $I_{IN+}$                  | 逻辑“1”输入偏置电流                  | $V_{IN} = 5\text{ V}$  | -   | 5    | 40   | $\mu\text{A}$ |
| $I_{IN-}$                  | 逻辑“0”输入偏置电流                  | $V_{IN} = 0\text{ V}$  | -   | 1.0  | 2.0  |               |
| $I_{O+}$                   | 输出高电平短路脉冲电流                  | $V_O = 0\text{ V}, V_{IN} = 5\text{ V with } PW \leq 10\ \mu\text{s}$  | 60  | 90   | -    | $\text{mA}$   |
| $I_{O-}$                   | 输出低电平短路脉冲电流                  | $V_O = 15\text{ V}, V_{IN} = 0\text{ V with } PW \leq 10\ \mu\text{s}$ | 130 | 180  | -    |               |
| $V_S$                      | IN 信号传播到 HO 时允许的 $V_S$ 引脚负电压 |  | -   | -9.8 | -7.0 | V             |

Product parametric performance is indicated in the Electrical Characteristics for the listed test conditions, unless otherwise noted. Product performance may not be indicated by the Electrical Characteristics if operated under different conditions.

(参考译文)

除非另有说明, “电气特性”表格中列出的是所列测试条件下的产品性能参数。如果在不同条件下运行, 产品性能可能与“电气特性”表格中所列性能参数不一致。

动态电气特性 (除非另有规定, 否则  $V_{BIAS} (V_{CC}, V_{BS}) = 15.0\text{ V}$ 、 $V_S = \text{COM}$ 、 $C_L = 1000\text{ pF}$ 、 $T_A = 25^\circ\text{C}$ 。)

| 符号        | 参数                    | 工作条件                                       | 最小值 | 典型值 | 最大值 | 单位 |
|-----------|-----------------------|--|-----|-----|-----|----|
| $t_{on}$  | 导通传播延时                | $V_S = 0\text{ V}$                         | 70  | 135 | 200 | ns |
| $t_{off}$ | 关断传播延时                | $V_S = 0\text{ V or } 600\text{ V (说明 4)}$ | 60  | 130 | 190 |    |
| $t_r$     | 导通上升时间                |  | 160 | 230 | 290 |    |
| $t_f$     | 关断下降时间                |  | 20  | 90  | 160 |    |
| DT        | 死区时间                  |  | 80  | 120 | 190 |    |
| MT        | 延时匹配, HS 与 LS 导通 / 关断 |  | -   | -   | 50  |    |

Product parametric performance is indicated in the Electrical Characteristics for the listed test conditions, unless otherwise noted. Product performance may not be indicated by the Electrical Characteristics if operated under different conditions.

(参考译文)

除非另有说明, “电气特性”表格中列出的是所列测试条件下的产品性能参数。如果在不同条件下运行, 产品性能可能与“电气特性”表格中所列性能参数不一致。

4. 该参数由设计保证。

典型性能特征



图 4. 导通传播延时与电源电压



图 5. 导通传播延时与温度

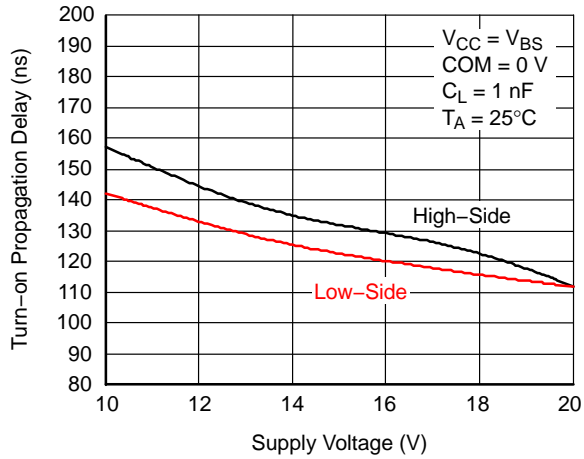

图 6. 关断传播延时与电源电压

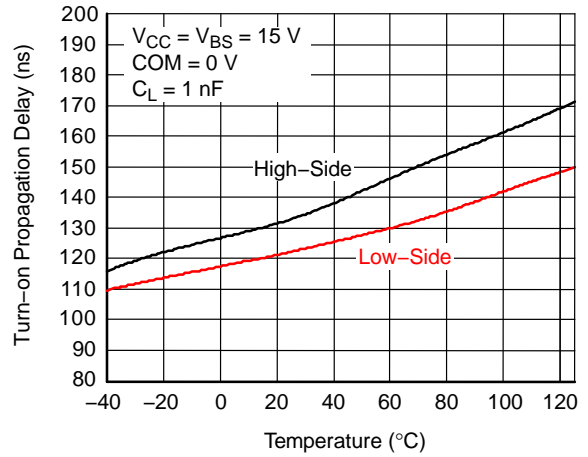

图 7. 关断传播延时与温度

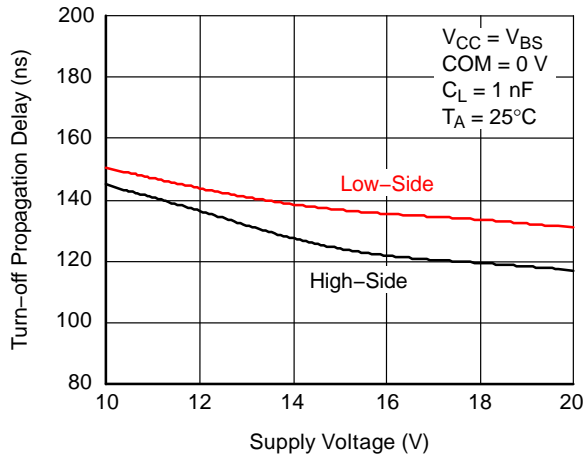

图 8. 导通上升时间与电源电压

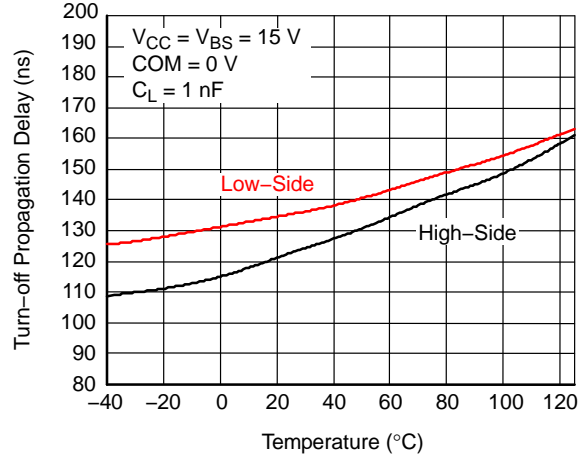

图 9. 导通上升时间与温度

# FAN7380

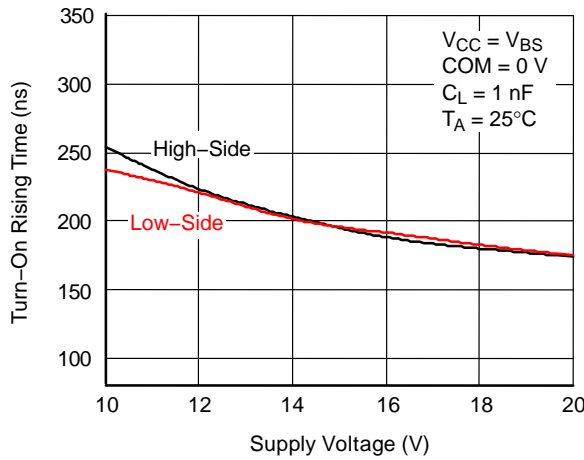
## 典型性能特征 (接上页)

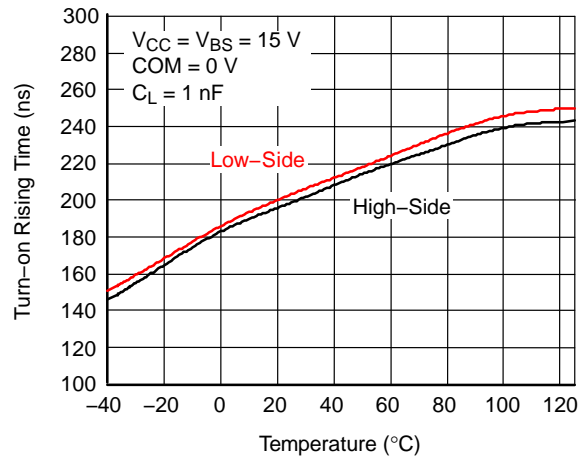

图 10. 关断下降时间与电源电压



图 11. 关断下降时间与温度

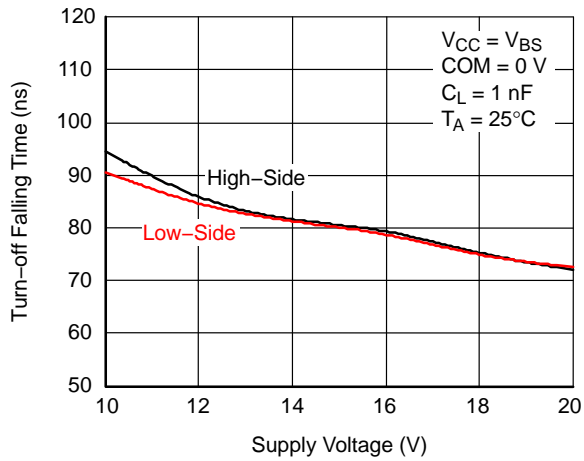

图 12. 死区时间与电源电压

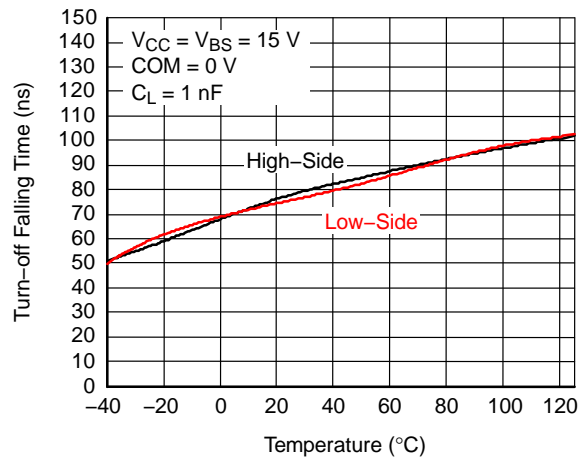

图 13. 死区时间与温度

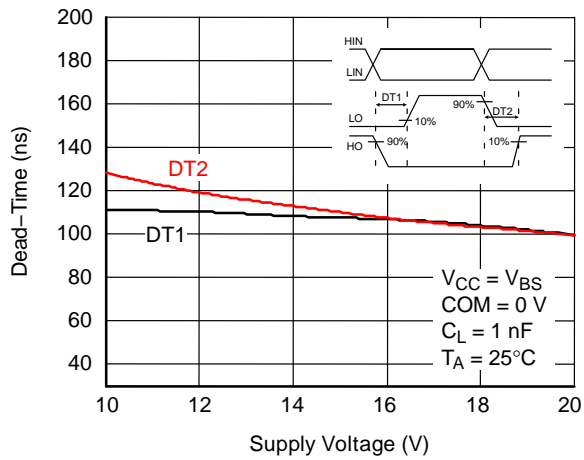

图 14. 输出源电流与电源电压

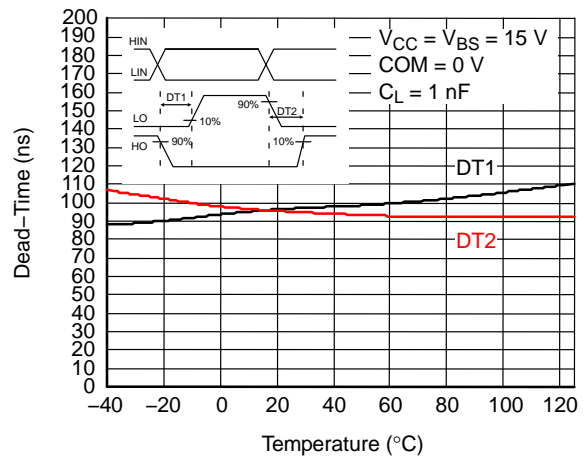

图 15. 输出源电流与温度

典型性能特征 (接上页)

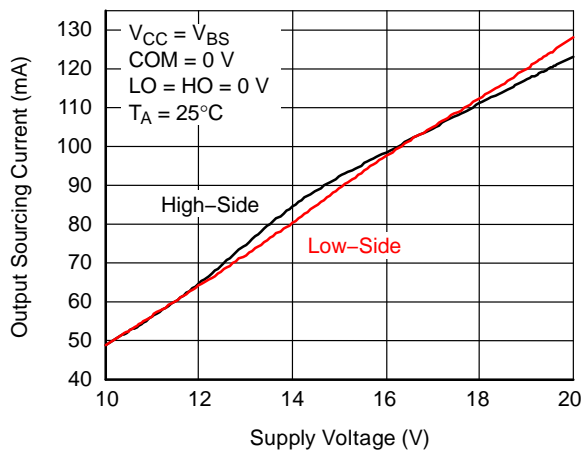

图 16. 输出灌电流与电源电压

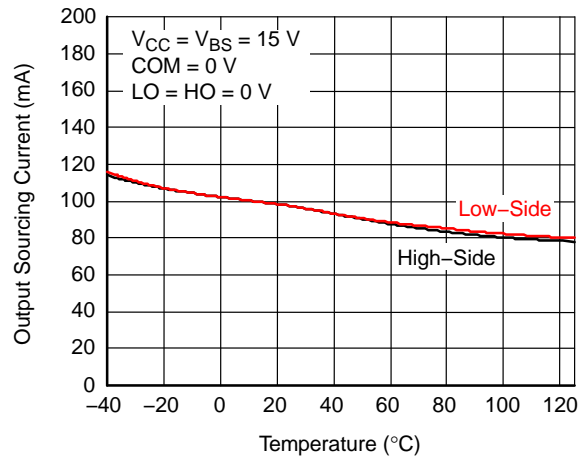

图 17. 输出灌电流与温度

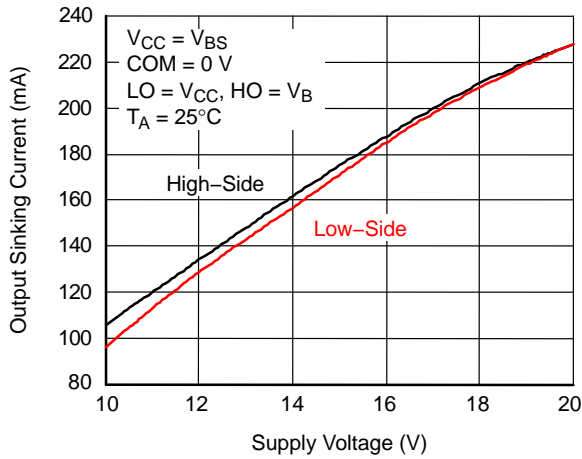

图 18. 信号传播至高端允许的  $V_S$  负电压与电源电压

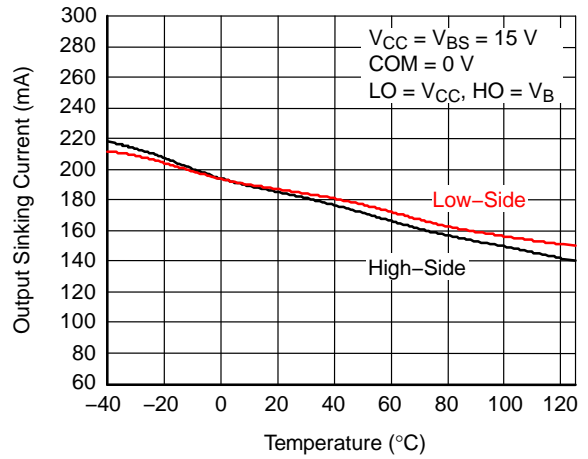

图 19. 信号传播至高端允许的  $V_S$  负电压与温度的关系

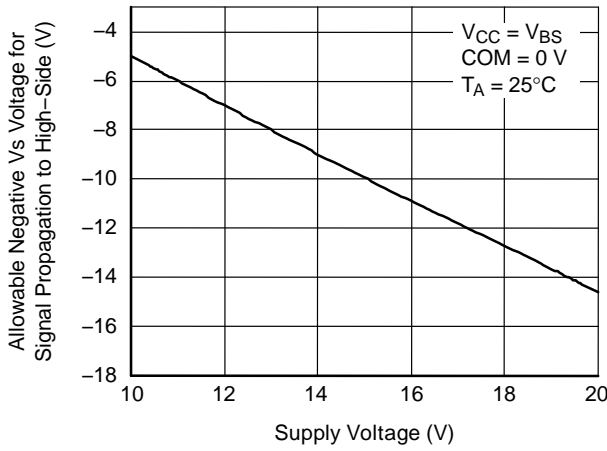

图 20.  $I_{QCC}$  与电源电压

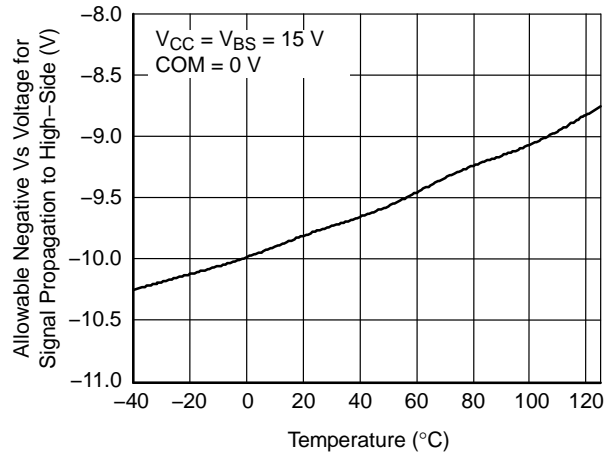

图 21.  $I_{QCC}$  与温度的关系

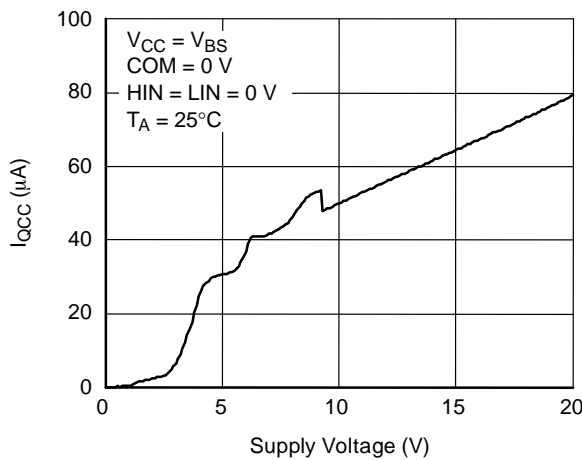

典型性能特征 (接上页)

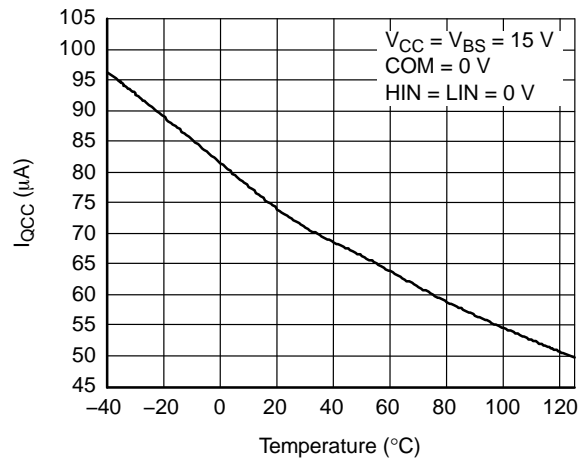

图 22.  $I_{QBS}$  与电源电压



图 23.  $I_{QBS}$  与温度的关系

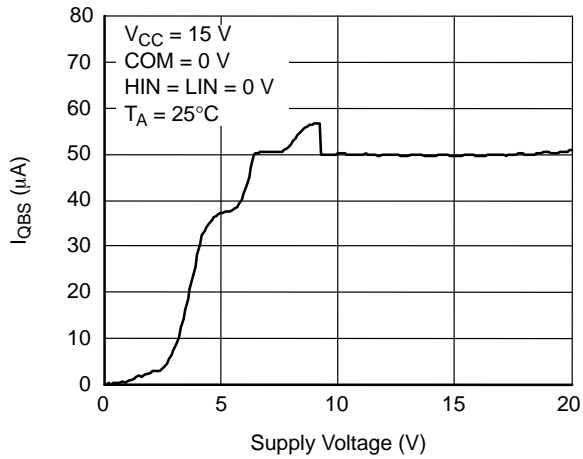

图 24. 高电平输出电压与电源电压

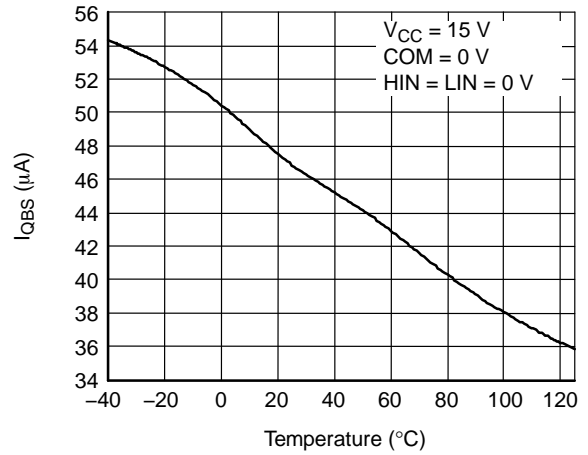

图 25. 高电平输出电压与温度

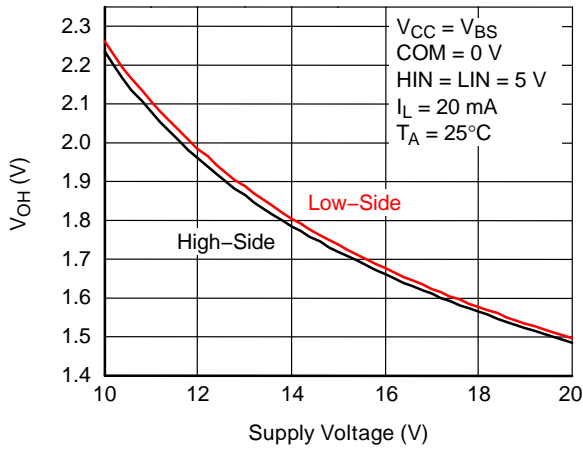

图 26. 低电平输出电压与电源电压

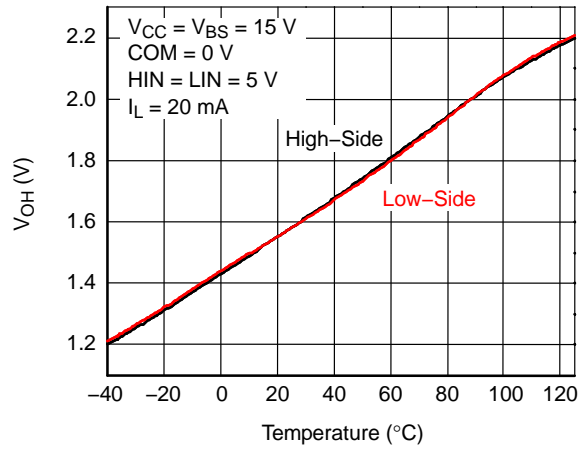

图 27. 低电平输出电压与温度

典型性能特征 (接上页)

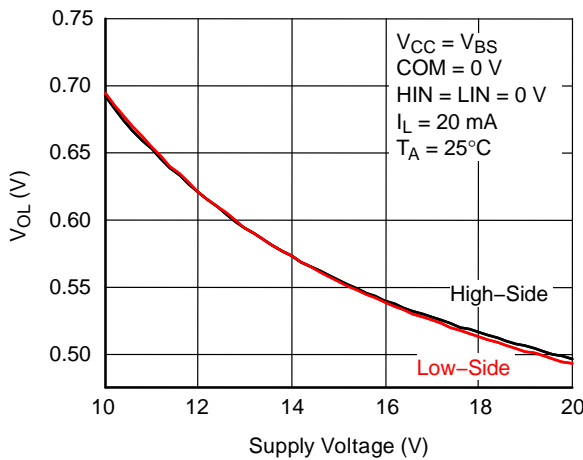

图 28. 输入偏置电流与电源电压

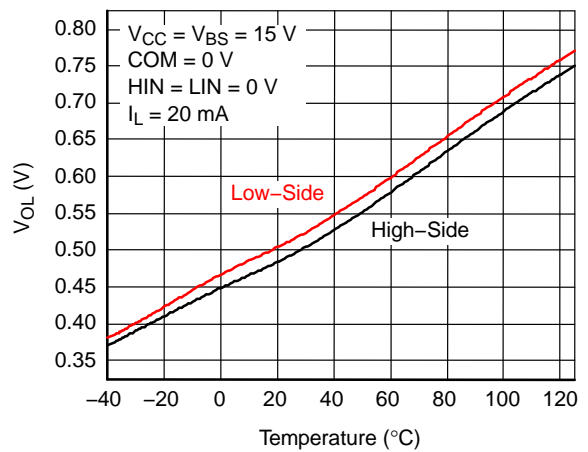

图 29. 输入偏置电流与温度的关系

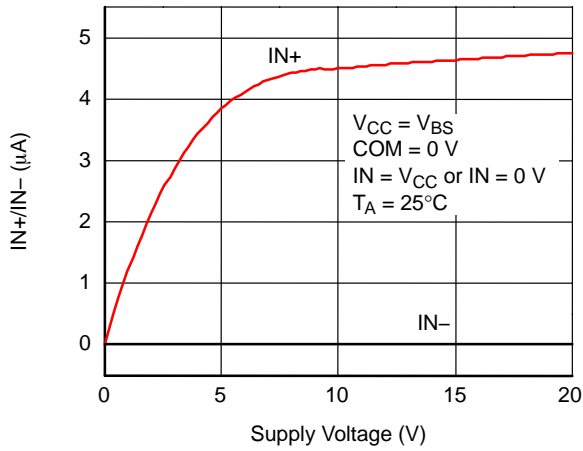

图 30.  $V_{CC}$  UVLO 阈值电压与温度

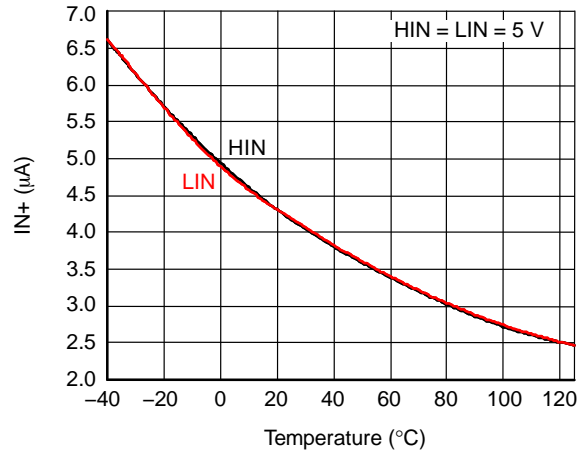

图 31.  $V_{BS}$  UVLO 阈值电压与温度

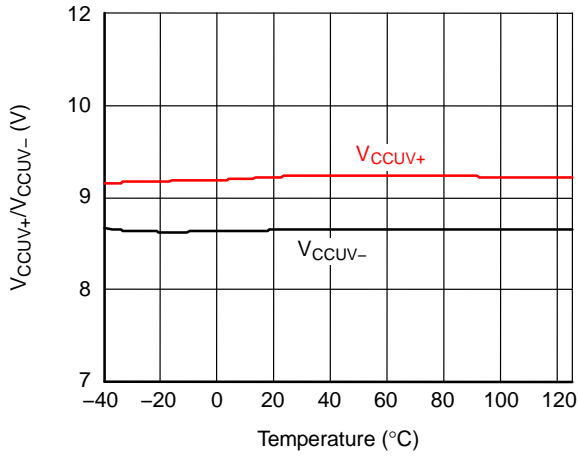

图 32. VB 至 COM 漏电流与温度

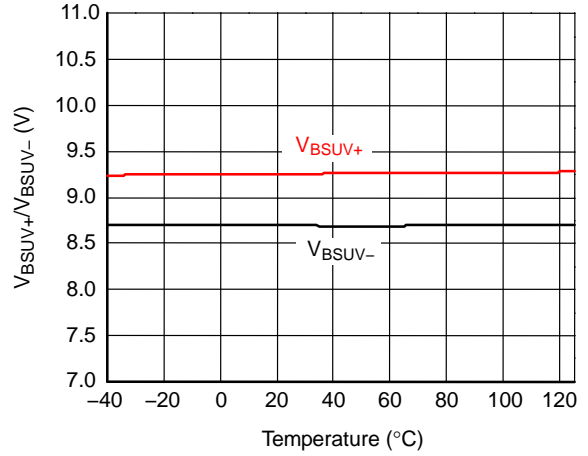

图 33. 输入逻辑阈值与温度

# FAN7380

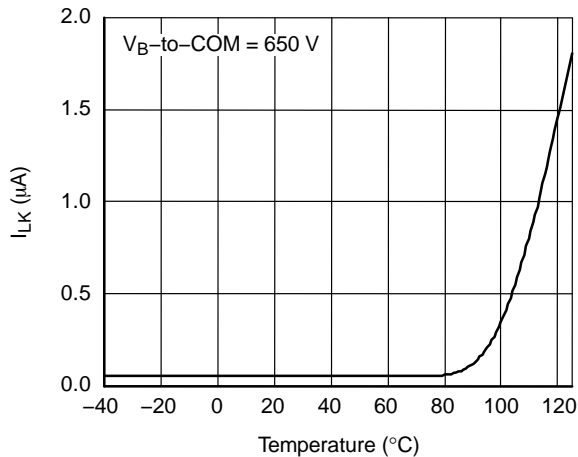
## 开关时间定义

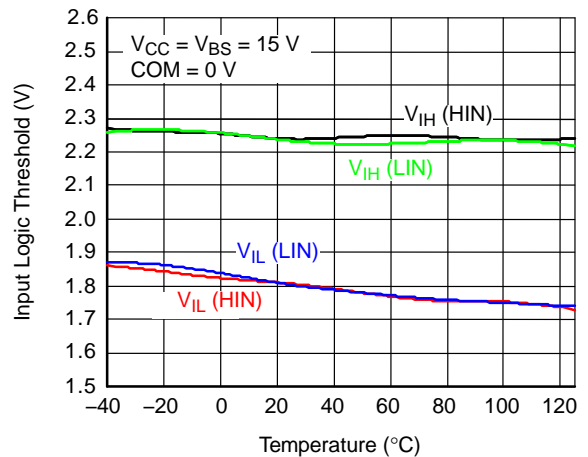

图 34. 开关时间波形



图 35. 内部死区时间时序

### 订购信息

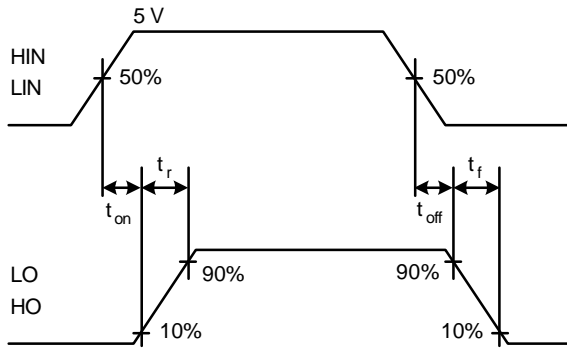
| 器件               | 封装            | 无铅 | 无铅           | 描述   | Shipping†    |
|------------------|---------------|----|--------------|------|--------------|
| FAN7380MX (说明 5) | SOIC8 (8-SOP) | 是  | -40°C~+125°C | 照明应用 | 3000 / 卷带和卷盘 |

†For information on tape and reel specifications, including part orientation and tape sizes, please refer to our Tape and Reel Packaging Specifications Brochure, BRD8011/D.

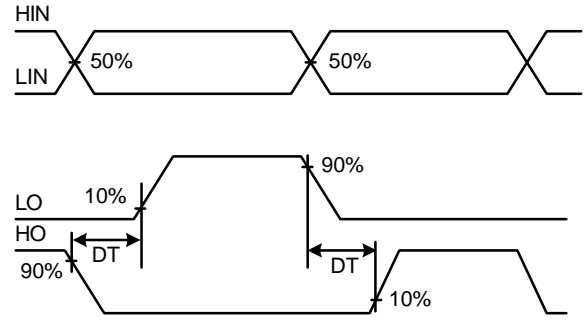
5. 该器件已通过 JESD22A-111 波动焊接测试。

**MECHANICAL CASE OUTLINE**  
**PACKAGE DIMENSIONS**

ON Semiconductor®



**SOIC8**  
**CASE 751EG**  
**ISSUE O**

DATE 30 SEP 2016

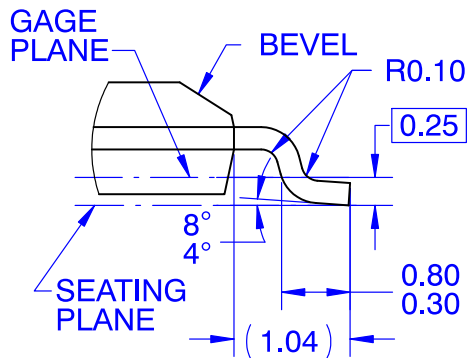
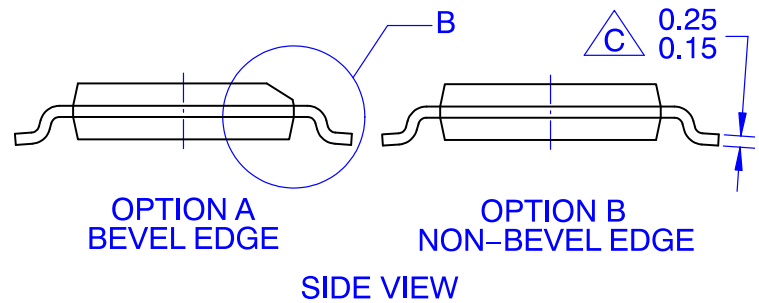
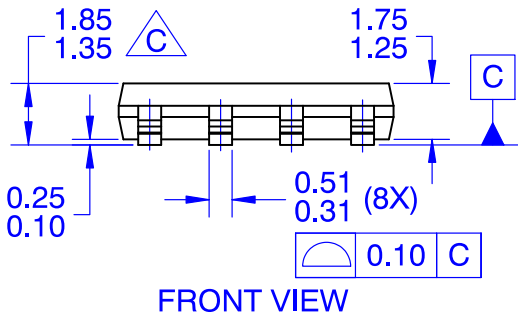
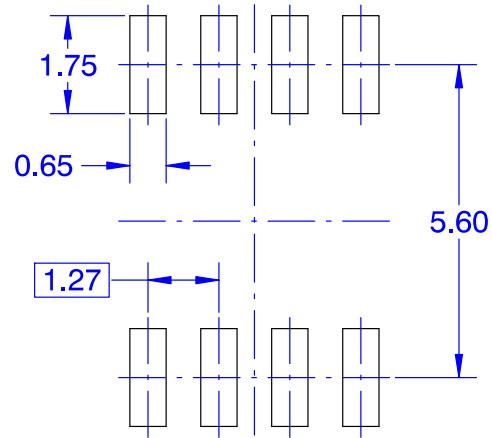
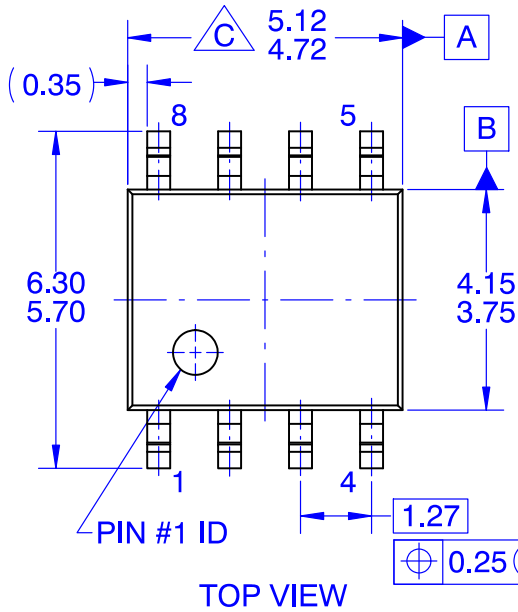

**NOTES: UNLESS OTHERWISE SPECIFIED**

- A. THIS PACKAGE CONFORMS TO JEDEC MS-012 VARIATION A EXCEPT WHERE NOTED.
- B. ALL DIMENSIONS ARE IN MILLIMETERS
- C. OUT OF JEDEC STANDARD VALUE
- D. DIMENSIONS ARE EXCLUSIVE OF BURRS, MOLD FLASH AND TIE BAR EXTRUSIONS.
- E. LAND PATTERN AS PER IPC SOIC127P600X175-8M

|                         |                    |  |
|-------------------------|--------------------|--|
| <b>DOCUMENT NUMBER:</b> | <b>98AON13741G</b> | Electronic versions are uncontrolled except when accessed directly from the Document Repository. Printed versions are uncontrolled except when stamped "CONTROLLED COPY" in red. |
| <b>DESCRIPTION:</b>     | <b>SOIC8</b>       | <b>PAGE 1 OF 1</b>   |

ON Semiconductor and are trademarks of Semiconductor Components Industries, LLC dba ON Semiconductor or its subsidiaries in the United States and/or other countries. ON Semiconductor reserves the right to make changes without further notice to any products herein. ON Semiconductor makes no warranty, representation or guarantee regarding the suitability of its products for any particular purpose, nor does ON Semiconductor assume any liability arising out of the application or use of any product or circuit, and specifically disclaims any and all liability, including without limitation special, consequential or incidental damages. ON Semiconductor does not convey any license under its patent rights nor the rights of others.

**onsemi**, **Onsemi**, and other names, marks, and brands are registered and/or common law trademarks of Semiconductor Components Industries, LLC dba "**onsemi**" or its affiliates and/or subsidiaries in the United States and/or other countries. **onsemi** owns the rights to a number of patents, trademarks, copyrights, trade secrets, and other intellectual property. A listing of **onsemi**'s product/patent coverage may be accessed at [www.onsemi.com/site/pdf/Patent-Marking.pdf](http://www.onsemi.com/site/pdf/Patent-Marking.pdf). **onsemi** reserves the right to make changes at any time to any products or information herein, without notice. The information herein is provided "as-is" and **onsemi** makes no warranty, representation or guarantee regarding the accuracy of the information, product features, availability, functionality, or suitability of its products for any particular purpose, nor does **onsemi** assume any liability arising out of the application or use of any product or circuit, and specifically disclaims any and all liability, including without limitation special, consequential or incidental damages. Buyer is responsible for its products and applications using **onsemi** products, including compliance with all laws, regulations and safety requirements or standards, regardless of any support or applications information provided by **onsemi**. "Typical" parameters which may be provided in **onsemi** data sheets and/or specifications can and do vary in different applications and actual performance may vary over time. All operating parameters, including "Typicals" must be validated for each customer application by customer's technical experts. **onsemi** does not convey any license under any of its intellectual property rights nor the rights of others. **onsemi** products are not designed, intended, or authorized for use as a critical component in life support systems or any FDA Class 3 medical devices or medical devices with a same or similar classification in a foreign jurisdiction or any devices intended for implantation in the human body. Should Buyer purchase or use **onsemi** products for any such unintended or unauthorized application, Buyer shall indemnify and hold **onsemi** and its officers, employees, subsidiaries, affiliates, and distributors harmless against all claims, costs, damages, and expenses, and reasonable attorney fees arising out of, directly or indirectly, any claim of personal injury or death associated with such unintended or unauthorized use, even if such claim alleges that **onsemi** was negligent regarding the design or manufacture of the part. **onsemi** is an Equal Opportunity/Affirmative Action Employer. This literature is subject to all applicable copyright laws and is not for resale in any manner.

## PUBLICATION ORDERING INFORMATION

### LITERATURE FULFILLMENT:

Email Requests to: [orderlit@onsemi.com](mailto:orderlit@onsemi.com)

**onsemi Website:** [www.onsemi.com](http://www.onsemi.com)

### TECHNICAL SUPPORT

**North American Technical Support:**

Voice Mail: 1 800-282-9855 Toll Free USA/Canada

Phone: 011 421 33 790 2910

**Europe, Middle East and Africa Technical Support:**

Phone: 00421 33 790 2910

For additional information, please contact your local Sales Representative