

Bipolar Transistor

**(-)50 V, (-)3 A, Low $V_{CE(sat)}$,
(PNP)NPN Single CPH6**

CPH6123, CPH6223

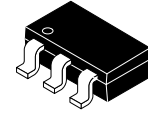

CPH6
CASE 318BD

Features

- Adoption of MBIT Process
- Large Current Capacity
- Low Collector-to-Emitter Saturation Voltage
- High-Speed Switching
- Ultrasmall Package Facilitates Miniaturization in End Products (Mounting Height: 0.9 mm)
- High Allowable Power Dissipation
- These are Pb-Free Devices

Applications

- DC-DC Converters, Relay Drivers, Lamp Drivers, Motor Drivers, Strobe

ABSOLUTE MAXIMUM RATINGS (at $T_A = 25^\circ\text{C}$)

Symbol	Parameter	Conditions	Ratings	Unit
V_{CBO}	Collector-to-Base Voltage		(-50)100	V
V_{CES}	Collector-to-Emitter Voltage		(-50)100	V
V_{CEO}	Collector-to-Emitter Voltage		(-)50	V
V_{EBO}	Emitter-to-Base Voltage		(-)6	V
I_C	Collector Current		(-)3	A
I_{CP}	Collector Current (Pulse)		(-)6	A
I_B	Base Current		(-)600	mA
P_C	Collector Dissipation	When mounted on ceramic substrate (600 mm ² x 0.8 mm)	1.3	W
T_j	Junction Temperature		150	°C
T_{stg}	Storage Temperature		-55 to +150	°C

Stresses exceeding those listed in the Maximum Ratings table may damage the device. If any of these limits are exceeded, device functionality should not be assumed, damage may occur and reliability may be affected.

ELECTRICAL CONNECTION

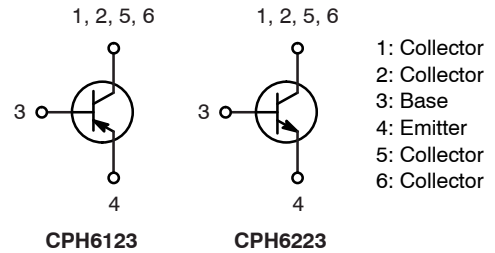

MARKING DIAGRAMS

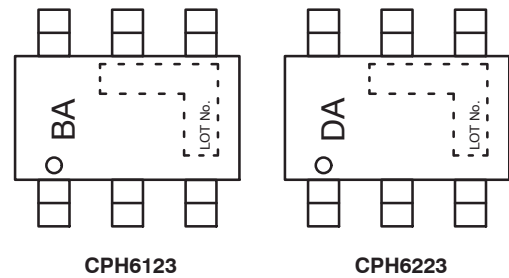

ORDERING INFORMATION

Device	Package	Shipping†
CPH6123-TL-E	CPH6 (Pb-Free)	3 000 / Tape & Reel
CPH6223-TL-E	CPH6 (Pb-Free)	3 000 / Tape & Reel

†For information on tape and reel specifications, including part orientation and tape sizes, please refer to our Tape and Reel Packaging Specification Brochure, [BRD8011/D](#).

CPH6123, CPH6223

ELECTRICAL CHARACTERISTICS (at $T_A = 25^\circ\text{C}$)

Symbol	Parameter	Test Conditions	Min	Typ	Max	Unit
I_{CBO}	Collector Cutoff Current	$V_{CB} = (-)40\text{ V}, I_E = 0\text{ A}$			(-) 1	μA
I_{EBO}	Emitter Cutoff Current	$V_{EB} = (-)4\text{ V}, I_C = 0\text{ A}$			(-) 1	μA
h_{FE}	DC Current Gain	$V_{CE} = (-)2\text{ V}, I_C = (-)100\text{ mA}$	200		560	
f_T	Gain-Bandwidth Product	$V_{CE} = (-)10\text{ V}, I_C = (-)500\text{ mA}$		(390) 380		MHz
C_{ob}	Output Capacitance	$V_{CB} = (-)10\text{ V}, f = 1\text{ MHz}$		(24) 13		pF
$V_{CE(sat)1}$	Collector-to-Emitter Saturation Voltage	$I_C = (-)1\text{ A}, I_B = (-)50\text{ mA}$		(-115) 90	(-230) 130	mV
$V_{CE(sat)2}$		$I_C = (-)2\text{ A}, I_B = (-)100\text{ mA}$		(-240) 160	(-650) 240	mV
$V_{BE(sat)}$	Base-to-Emitter Saturation Voltage	$I_C = (-)2\text{ A}, I_B = (-)100\text{ mA}$		(-) 0.88	(-) 1.2	V
$V_{(BR)CBO}$	Collector-to-Base Breakdown Voltage	$I_C = (-)10\text{ }\mu\text{A}, I_E = 0\text{ A}$	(-) 50	100		V
$V_{(BR)CES}$	Collector-to-Emitter Breakdown Voltage	$I_C = (-)100\text{ }\mu\text{A}, R_{BE} = 0\text{ }\Omega$	(-) 50	100		V
$V_{(BR)CEO}$	Collector-to-Emitter Breakdown Voltage	$I_C = (-)1\text{ mA}, R_{BE} = \infty$	(-) 50			V
$V_{(BR)EBO}$	Emitter-to-Base Breakdown Voltage	$I_E = (-)10\text{ }\mu\text{A}, I_C = 0\text{ A}$	(-) 6			V
t_{on}	Turn-On Time	See specified Test Circuit.		(30) 35		ns
t_{stg}	Storage Time			(230) 300		ns
t_f	Fall Time			(18) 25		ns

Product parametric performance is indicated in the Electrical Characteristics for the listed test conditions, unless otherwise noted. Product performance may not be indicated by the Electrical Characteristics if operated under different conditions.

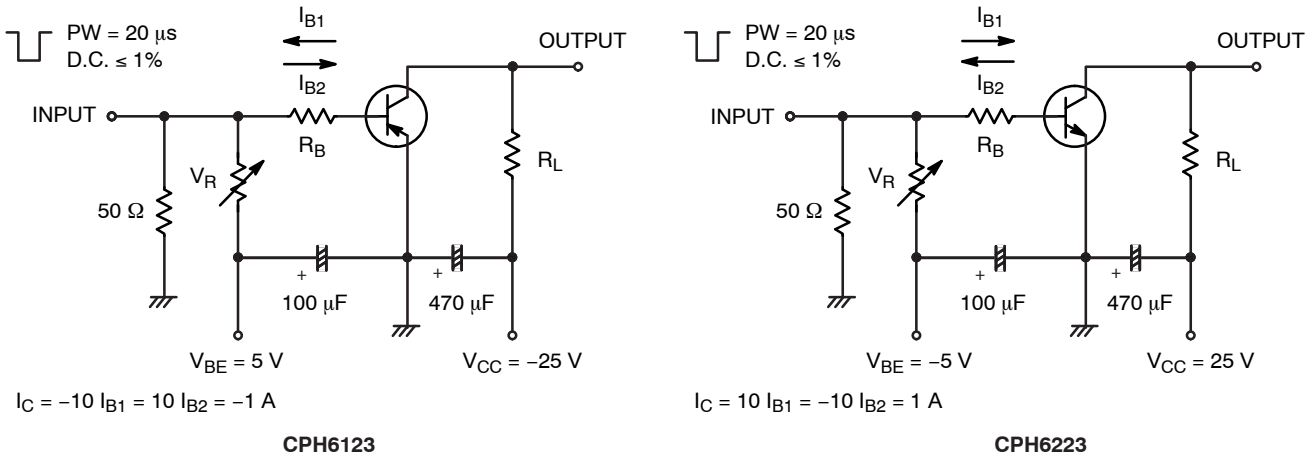

Figure 1. Switching Time Test Circuit

TYPICAL PERFORMANCE CHARACTERISTICS

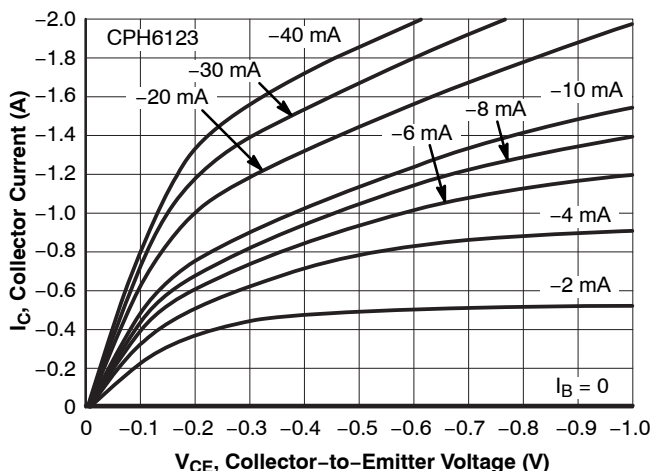

Figure 2. $I_C - V_{CE}$

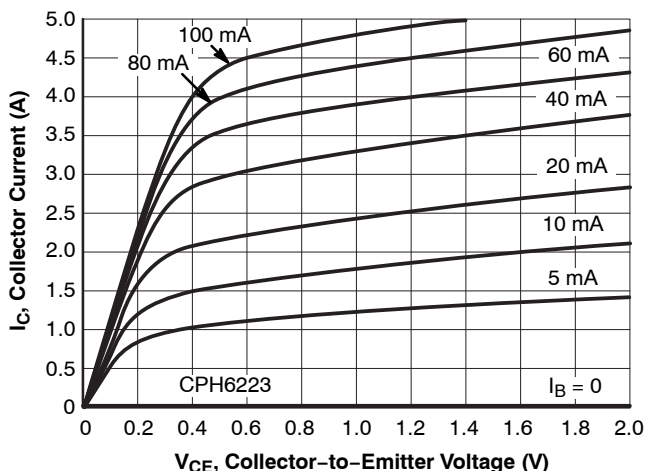

Figure 3. $I_C - V_{CE}$

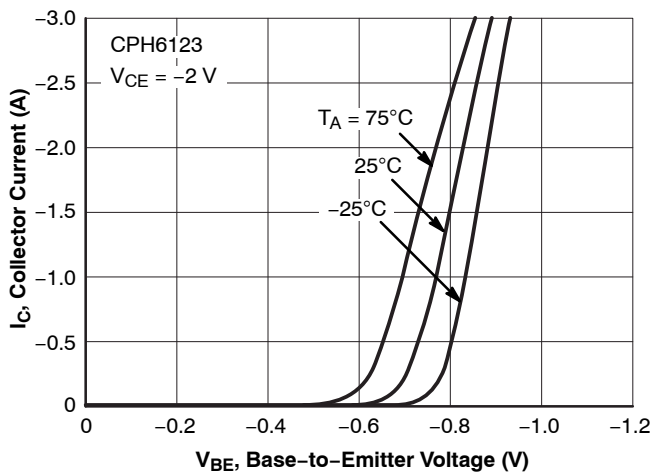

Figure 4. $I_C - V_{BE}$

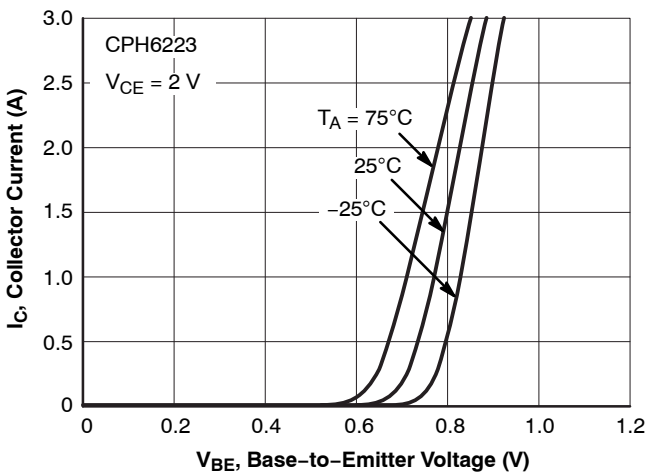

Figure 5. $I_C - V_{BE}$

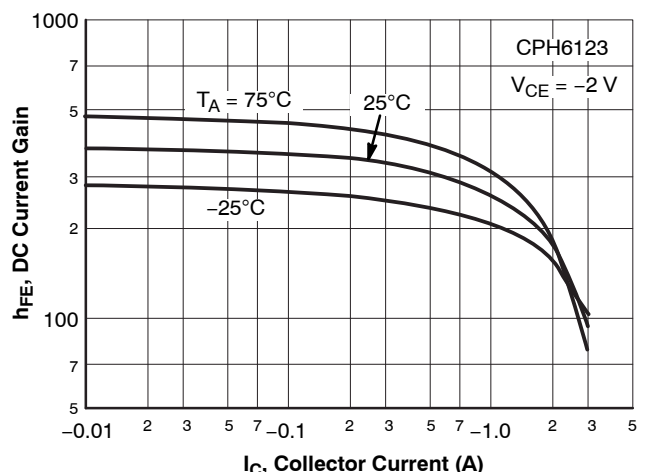

Figure 6. $h_{FE} - I_C$

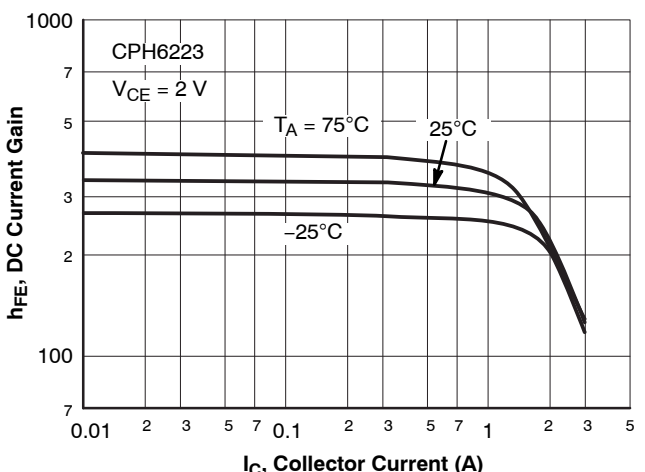
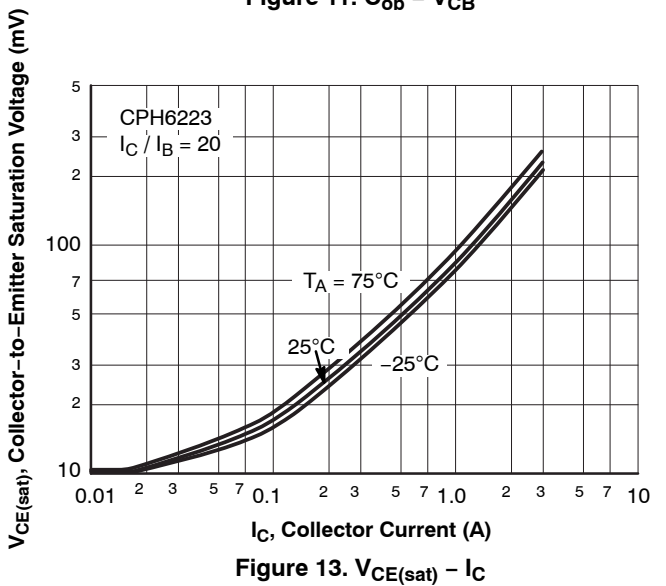
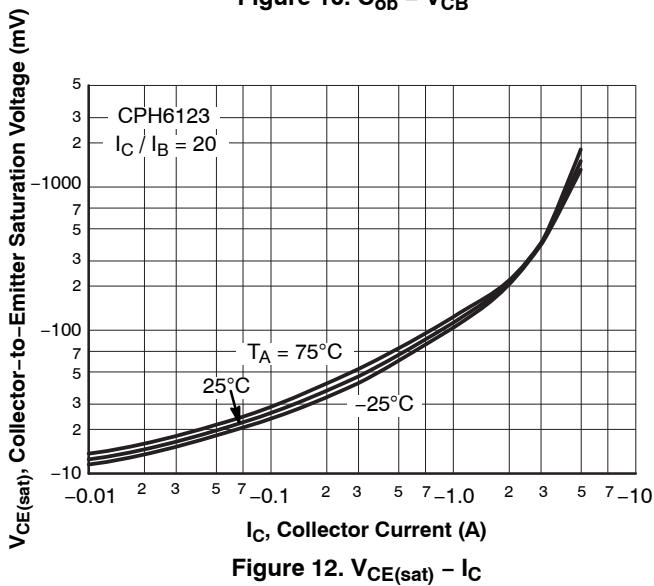
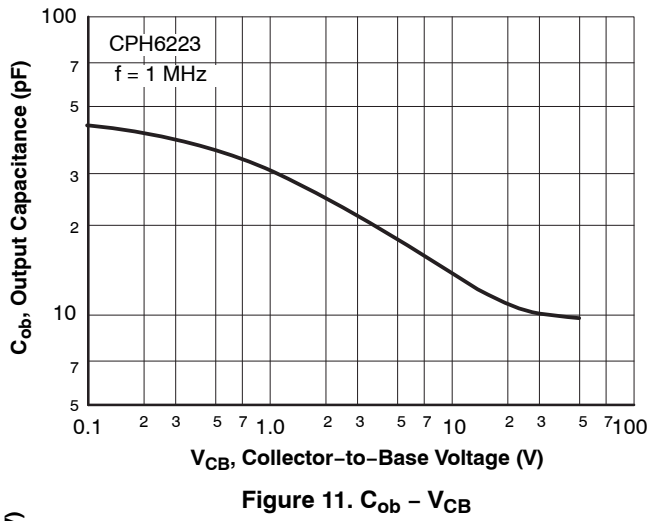
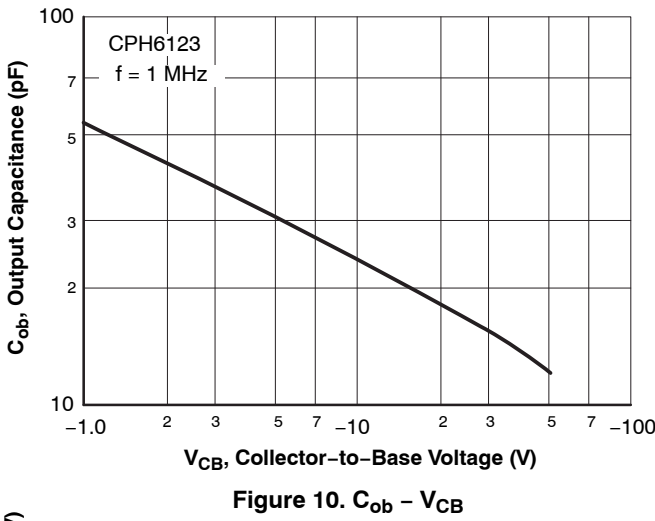
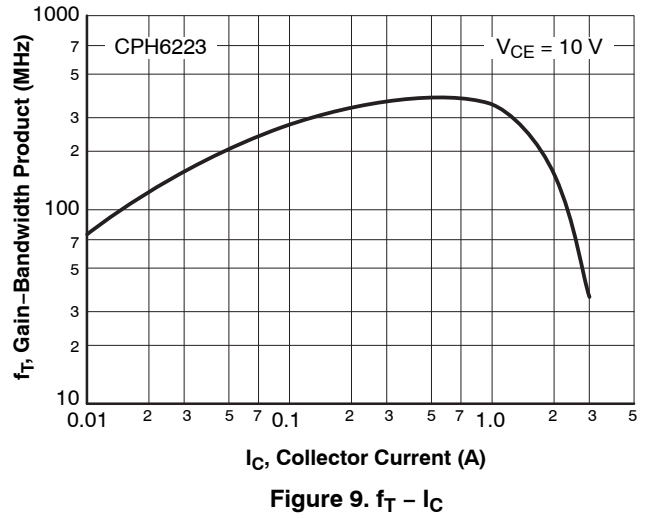
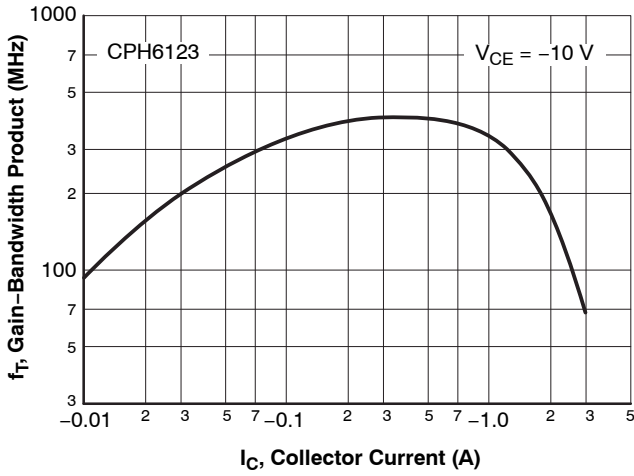

Figure 7. $h_{FE} - I_C$

CPH6123, CPH6223

TYPICAL PERFORMANCE CHARACTERISTICS (Continued)



TYPICAL PERFORMANCE CHARACTERISTICS (Continued)

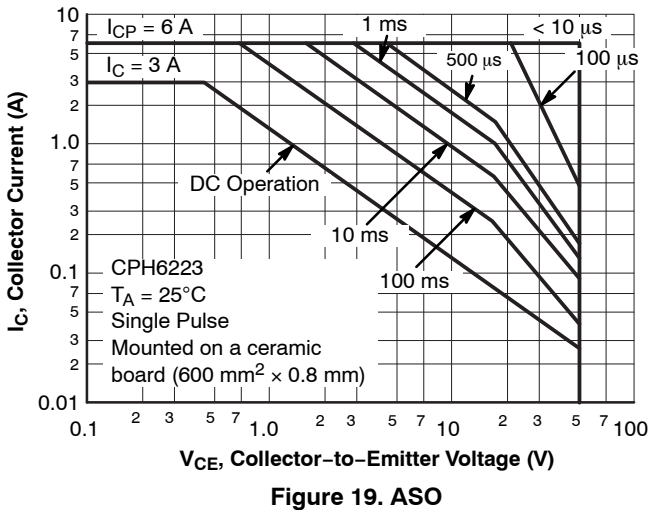
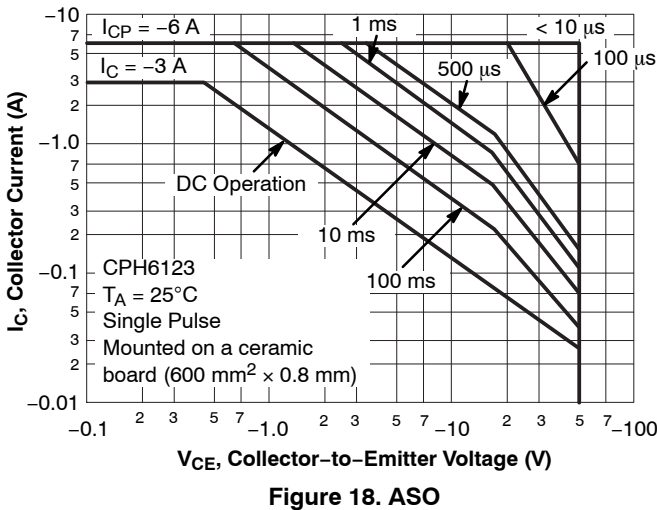
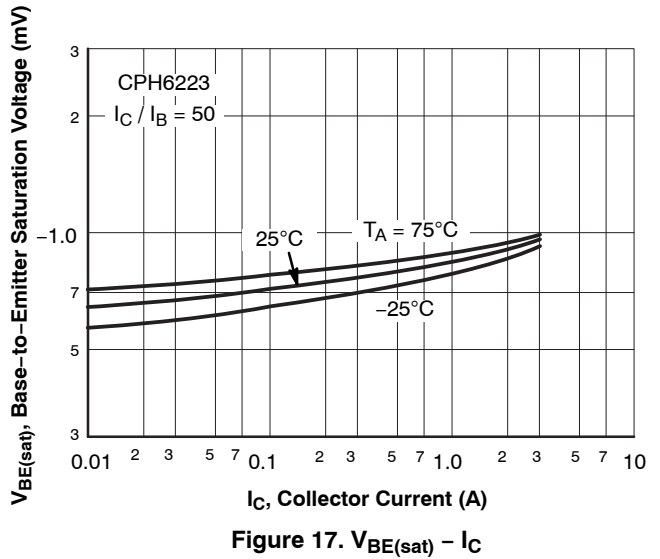
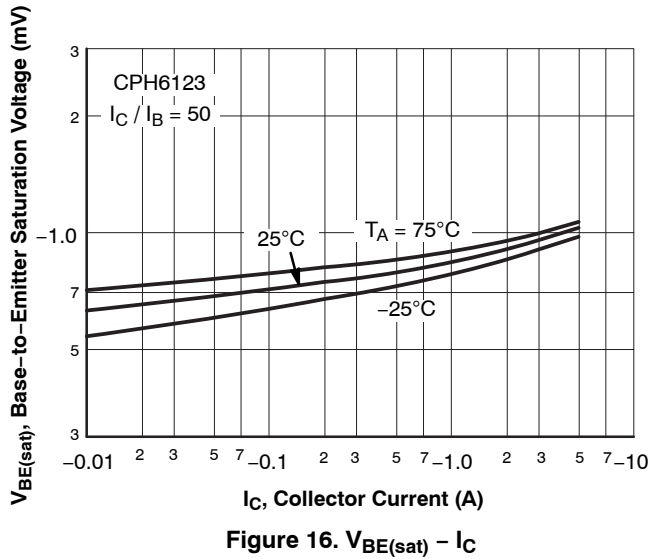
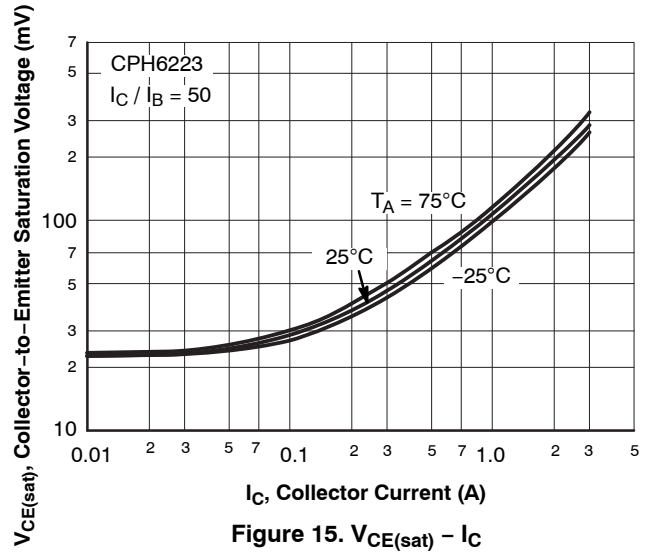
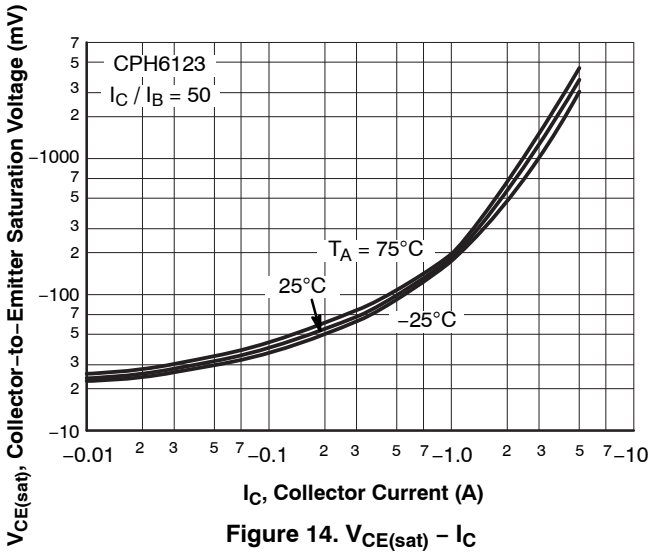

CPH6123, CPH6223

TYPICAL PERFORMANCE CHARACTERISTICS (Continued)

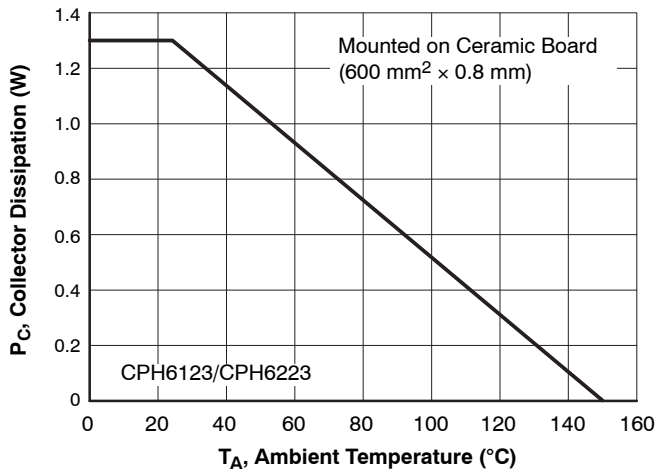
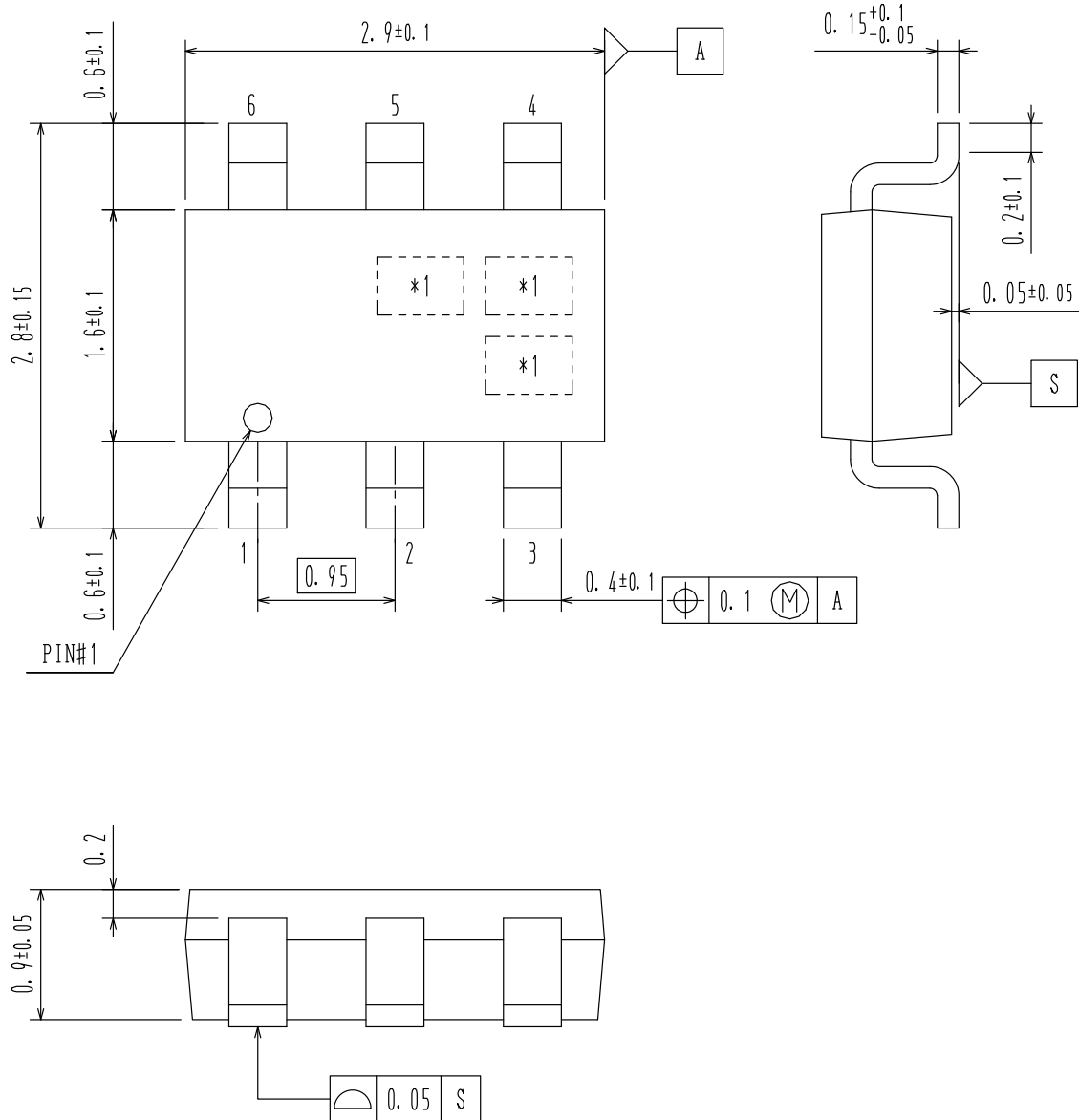

Figure 20. $P_C - T_A$

CPH6
CASE 318BD
ISSUE O

DATE 30 NOV 2011



DOCUMENT NUMBER:	98AON65440E	Electronic versions are uncontrolled except when accessed directly from the Document Repository. Printed versions are uncontrolled except when stamped "CONTROLLED COPY" in red.
DESCRIPTION:	CPH6	PAGE 1 OF 1

ON Semiconductor and are trademarks of Semiconductor Components Industries, LLC dba ON Semiconductor or its subsidiaries in the United States and/or other countries. ON Semiconductor reserves the right to make changes without further notice to any products herein. ON Semiconductor makes no warranty, representation or guarantee regarding the suitability of its products for any particular purpose, nor does ON Semiconductor assume any liability arising out of the application or use of any product or circuit, and specifically disclaims any and all liability, including without limitation special, consequential or incidental damages. ON Semiconductor does not convey any license under its patent rights nor the rights of others.

onsemi, **Onsemi**, and other names, marks, and brands are registered and/or common law trademarks of Semiconductor Components Industries, LLC dba "**onsemi**" or its affiliates and/or subsidiaries in the United States and/or other countries. **onsemi** owns the rights to a number of patents, trademarks, copyrights, trade secrets, and other intellectual property. A listing of **onsemi**'s product/patent coverage may be accessed at www.onsemi.com/site/pdf/Patent-Marking.pdf. **onsemi** reserves the right to make changes at any time to any products or information herein, without notice. The information herein is provided "as-is" and **onsemi** makes no warranty, representation or guarantee regarding the accuracy of the information, product features, availability, functionality, or suitability of its products for any particular purpose, nor does **onsemi** assume any liability arising out of the application or use of any product or circuit, and specifically disclaims any and all liability, including without limitation special, consequential or incidental damages. Buyer is responsible for its products and applications using **onsemi** products, including compliance with all laws, regulations and safety requirements or standards, regardless of any support or applications information provided by **onsemi**. "Typical" parameters which may be provided in **onsemi** data sheets and/or specifications can and do vary in different applications and actual performance may vary over time. All operating parameters, including "Typicals" must be validated for each customer application by customer's technical experts. **onsemi** does not convey any license under any of its intellectual property rights nor the rights of others. **onsemi** products are not designed, intended, or authorized for use as a critical component in life support systems or any FDA Class 3 medical devices or medical devices with a same or similar classification in a foreign jurisdiction or any devices intended for implantation in the human body. Should Buyer purchase or use **onsemi** products for any such unintended or unauthorized application, Buyer shall indemnify and hold **onsemi** and its officers, employees, subsidiaries, affiliates, and distributors harmless against all claims, costs, damages, and expenses, and reasonable attorney fees arising out of, directly or indirectly, any claim of personal injury or death associated with such unintended or unauthorized use, even if such claim alleges that **onsemi** was negligent regarding the design or manufacture of the part. **onsemi** is an Equal Opportunity/Affirmative Action Employer. This literature is subject to all applicable copyright laws and is not for resale in any manner.

PUBLICATION ORDERING INFORMATION

LITERATURE FULFILLMENT:

Email Requests to: orderlit@onsemi.com

onsemi Website: www.onsemi.com

TECHNICAL SUPPORT

North American Technical Support:

Voice Mail: 1 800-282-9855 Toll Free USA/Canada

Phone: 011 421 33 790 2910

Europe, Middle East and Africa Technical Support:

Phone: 00421 33 790 2910

For additional information, please contact your local Sales Representative