

# NSM80100MT1G

## PNP Transistor with Dual Series Switching Diode

### Features

- These Devices are Pb-Free, Halogen Free/BFR Free and are RoHS Compliant

### Typical Applications

- LCD Control Board
- High Speed Switching
- High Voltage Switching

### MAXIMUM RATINGS – PNP TRANSISTOR

Rating	Symbol	Value	Unit
Collector–Emitter Voltage	$V_{CEO}$	-80	Vdc
Collector–Base Voltage	$V_{CBO}$	-80	Vdc
Emitter–Base Voltage	$V_{EBO}$	-4.0	Vdc
Collector Current – Continuous	$I_C$	-500	mAdc

### MAXIMUM RATINGS – SWITCHING DIODE

Rating	Symbol	Value	Unit
Reverse Voltage	$V_R$	100	V
Forward Current	$I_F$	200	mA
Non-Repetitive Peak Forward Current (Square Wave, $T_J = 25^\circ\text{C}$ prior to surge) $t < 1 \text{ sec}$ $t = 1 \mu\text{sec}$	$I_{FSM}$	1.0 20	A
Operating and Storage Junction Temperature Range	$T_J, T_{stg}$	-55 to +150	$^\circ\text{C}$

Stresses exceeding those listed in the Maximum Ratings table may damage the device. If any of these limits are exceeded, device functionality should not be assumed, damage may occur and reliability may be affected.

### ESD RATINGS

Rating	Class	Value
Electrostatic Discharge	HBM MM	3A M4 4000 V ≤ Failure < 8000 V Failure > 400 V

### THERMAL CHARACTERISTICS

Rating	Symbol	Max	Unit
Total Device Dissipation FR-5 Board, (Note 1) @ $T_A = 25^\circ\text{C}$ Derate above $25^\circ\text{C}$	$P_D$	400	mW mW/ $^\circ\text{C}$
Thermal Resistance from Junction-to-Ambient (Note 1)	$R_{\theta JA}$	313	$^\circ\text{C}/\text{W}$
Total Device Dissipation FR-5 Board (Note 2) $T_A = 25^\circ\text{C}$ Derate above $25^\circ\text{C}$	$P_D$	270	mW mW/ $^\circ\text{C}$
Thermal Resistance, Junction-to-Ambient (Note 2)	$R_{\theta JA}$	463	$^\circ\text{C}/\text{W}$
Junction and Storage Temperature Range	$T_J, T_{stg}$	-55 to +150	$^\circ\text{C}$

1. FR-5 = 650 mm<sup>2</sup> pad, 2.0 oz Cu.
2. FR-5 = 10 mm<sup>2</sup> pad, 2.0 oz Cu.



ON Semiconductor®

<http://onsemi.com>

## PNP Transistor with Dual Series Switching Diode

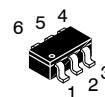
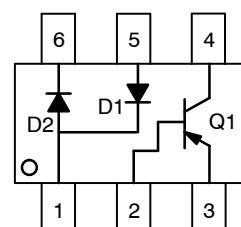

SC-74  
CASE 318F

### MARKING DIAGRAM

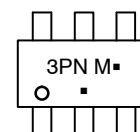

3PN = Device Code  
M = Date Code\*  
▪ = Pb-Free Package

(Note: Microdot may be in either location)  
\*Date Code orientation may vary depending upon manufacturing location.

### ORDERING INFORMATION

Device	Package	Shipping†
NSM80100MT1G	SC-74 (Pb-Free)	3000 / Tape & Reel

†For information on tape and reel specifications, including part orientation and tape sizes, please refer to our Tape and Reel Packaging Specification Brochure, BRD8011/D.

# NSM80100MT1G

## Q1: PNP TRANSISTOR

### ELECTRICAL CHARACTERISTICS ( $T_A = 25^\circ\text{C}$ unless otherwise noted)

Characteristic	Symbol	Min	Max	Unit
<b>OFF CHARACTERISTICS</b>				
Collector – Emitter Breakdown Voltage (Note 3) $(I_C = -1.0 \text{ mA}, I_B = 0)$	$V_{(BR)CEO}$	-80	-	V
Emitter – Base Breakdown Voltage $(I_E = -100 \mu\text{A}, I_C = 0)$	$V_{(BR)EBO}$	-4.0	-	V
Collector Cutoff Current $(V_{CE} = -60 \text{ V}, I_B = 0)$	$I_{CES}$	-	-0.1	$\mu\text{A}$
Collector Cutoff Current $(V_{CB} = -80 \text{ V}, I_E = 0)$	$I_{CBO}$	-	-0.1	$\mu\text{A}$

### ON CHARACTERISTICS (Note 3)

DC Current Gain $(I_C = -10 \text{ mA}, V_{CE} = -1.0 \text{ V})$	$h_{FE}$	120	-	-
Collector – Emitter Saturation Voltage $(I_C = -100 \text{ mA}, I_B = -10 \text{ mA})$	$V_{CE(sat)}$	-	-0.25	V
Base – Emitter Saturation Voltage $(I_C = -100 \text{ mA}, V_{CE} = -1.0 \text{ V})$	$V_{BE(sat)}$	-	-1.2	V

### SMALL-SIGNAL CHARACTERISTICS

Current – Gain – Bandwidth Product (Note 4) $(I_C = -100 \text{ mA}, V_{CE} = -2.0 \text{ V}, f = 100 \text{ MHz})$	$f_T$	150	-	MHz
--	-------	-----	---	-----

3. Pulse Test: Pulse Width  $\leq 300 \mu\text{s}$ , Duty Cycle  $\leq 2.0\%$ .

4.  $f_T$  is defined as the frequency at which  $|h_{fe}|$  extrapolates to unity.

## D1, D2: SWITCHING DIODE ( $T_A = 25^\circ\text{C}$ unless otherwise noted)

Characteristic	Symbol	Min	Max	Unit
<b>OFF CHARACTERISTICS</b>				
Reverse Breakdown Voltage	$V_{(BR)}$	75	-	V
Reverse Voltage Leakage Current $(V_R = 75 \text{ V})$ $(V_R = 20 \text{ V}, T_J = 150^\circ\text{C})$ $(V_R = 75 \text{ V}, T_J = 150^\circ\text{C})$	$I_R$	-	1.0 30 100	$\mu\text{A}$
Diode Capacitance $(V_R = 0 \text{ V}, f = 1.0 \text{ MHz})$	$C_D$	-	1.5	pF
Forward Voltage $(I_F = 1.0 \text{ mA})$ $(I_F = 10 \text{ mA})$ $(I_F = 50 \text{ mA})$ $(I_F = 150 \text{ mA})$	$V_F$	-	715 855 1000 1250	mV
Reverse Recovery Time $(I_F = I_R = 10 \text{ mA}, i_{R(REC)} = 1.0 \text{ mA}, R_L = 100 \Omega)$	$t_{rr}$	-	4.0	ns
Forward Recovery Voltage $(I_F = 10 \text{ mA}, t_r = 20 \text{ ns})$	$V_{FR}$	-	1.75	V

Product parametric performance is indicated in the Electrical Characteristics for the listed test conditions, unless otherwise noted. Product performance may not be indicated by the Electrical Characteristics if operated under different conditions.

# N5M80100MT1G

## TYPICAL CHARACTERISTICS

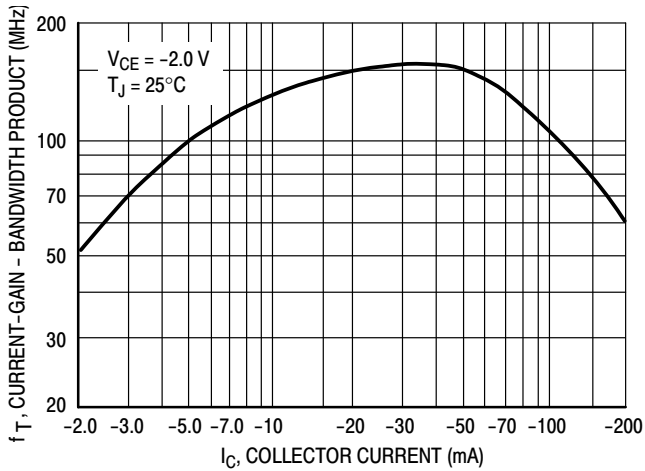

Figure 1. Current-Gain — Bandwidth Product

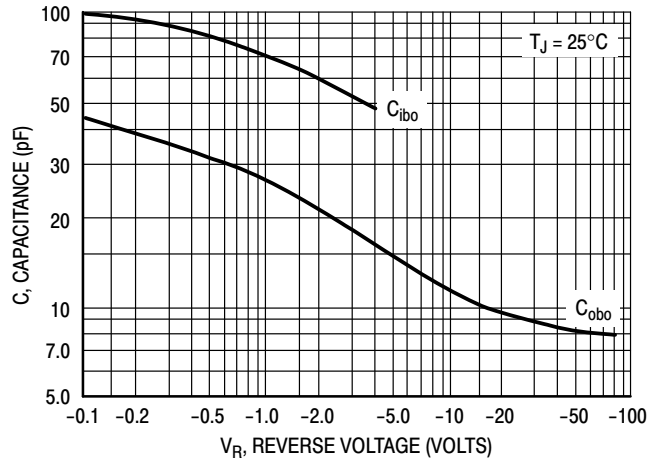

Figure 2. Capacitance

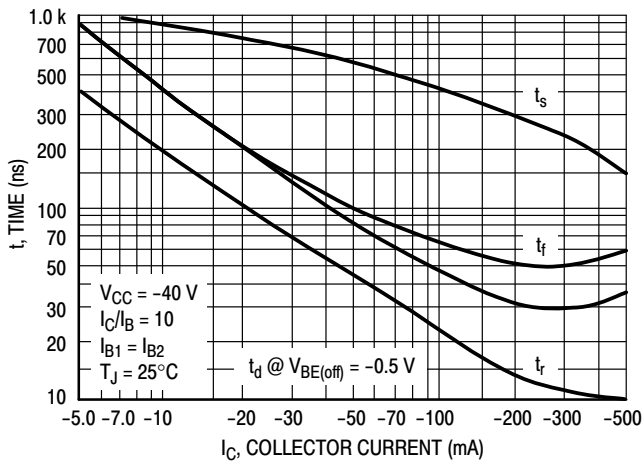

Figure 3. Switching Time

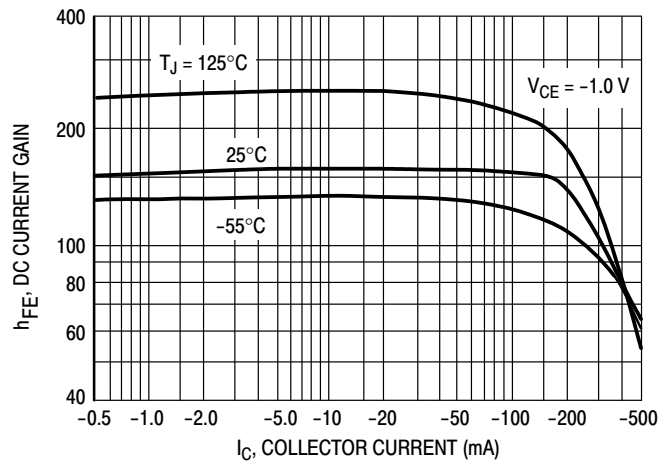

Figure 4. DC Current Gain

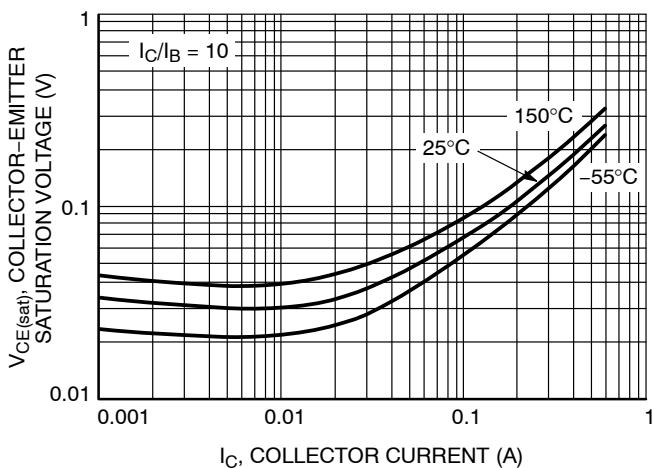

Figure 5. Collector Emitter Saturation Voltage vs. Collector Current

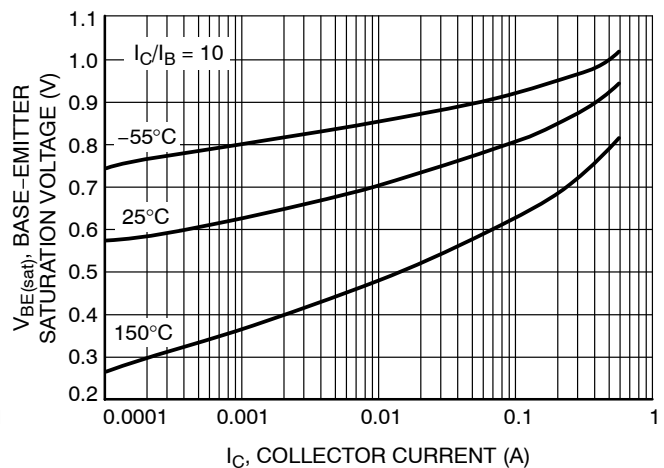
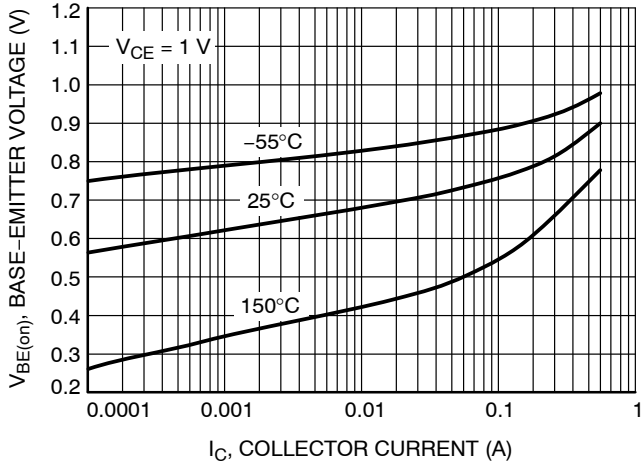

Figure 6. Base Emitter Saturation Voltage vs. Collector Current

# NSM80100MT1G

## TYPICAL CHARACTERISTICS



**Figure 7. Base-Emitter Voltage vs. Collector Current**

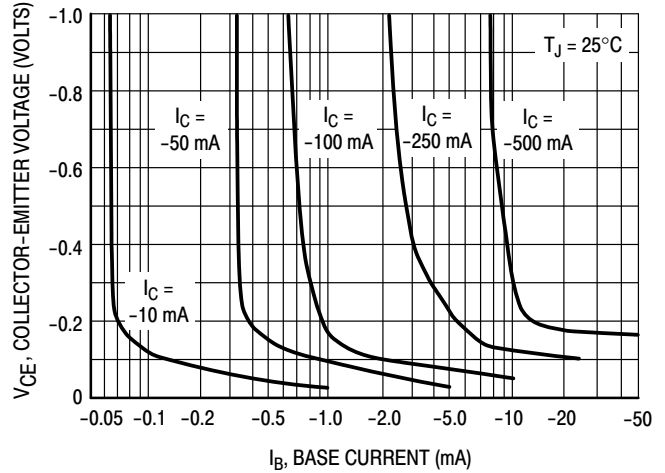

**Figure 8. Collector Saturation Region**

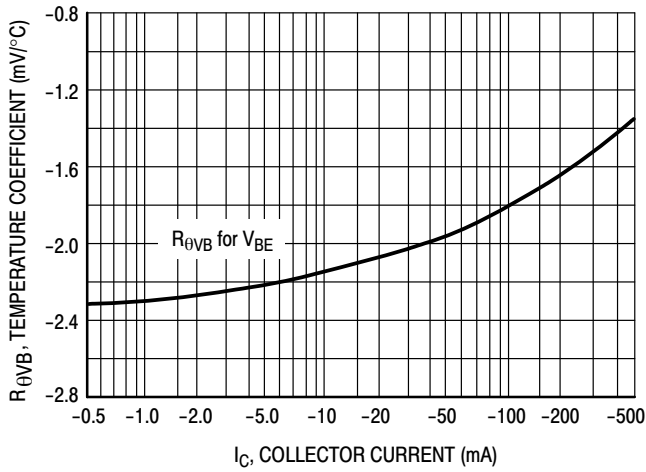

**Figure 9. Base-Emitter Temperature Coefficient**

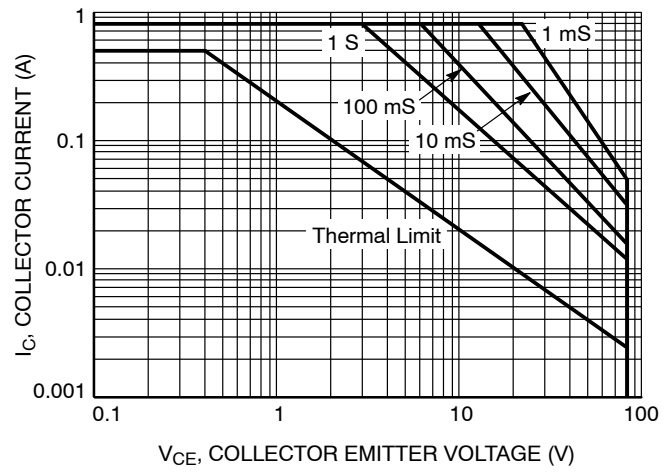

**Figure 10. Safe Operating Area**

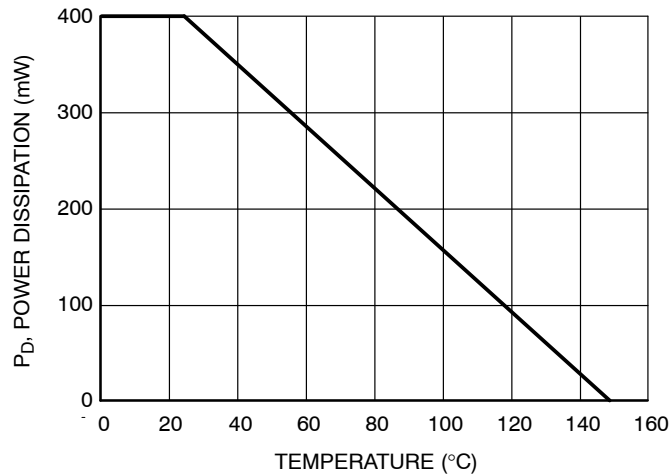

**Figure 11. Operating Temperature Derating**

# NSM80100MT1G

## TYPICAL CHARACTERISTICS

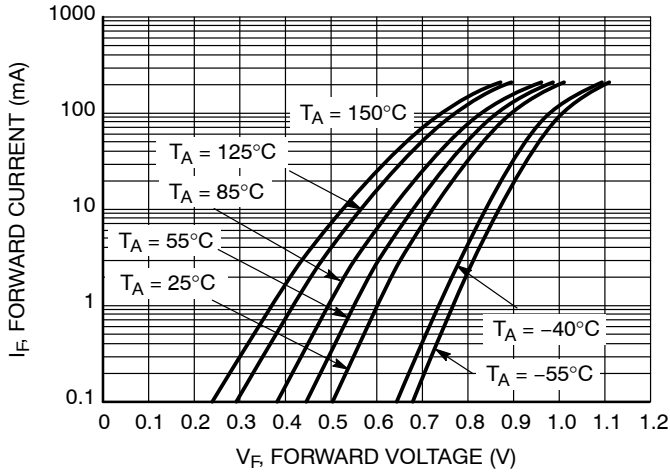

Figure 12. Forward Voltage

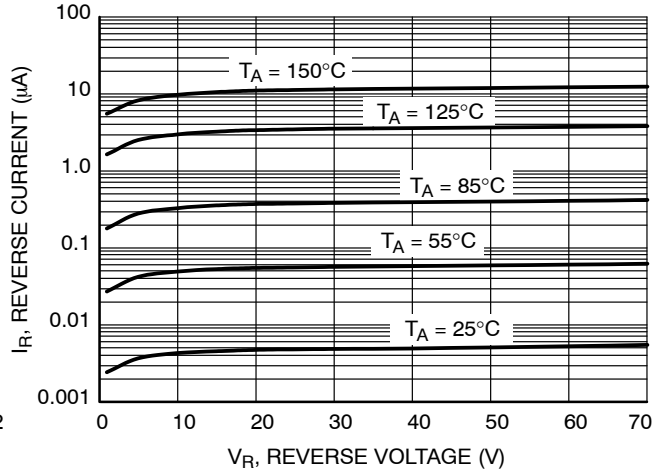

Figure 13. Leakage Current

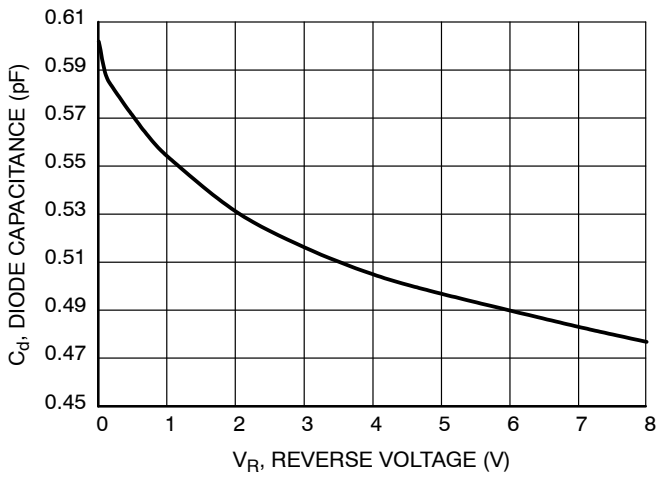

Figure 14. Capacitance

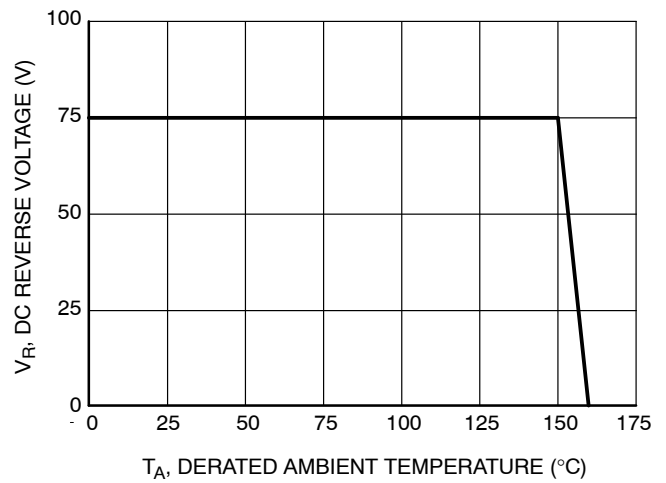

Figure 15. Diode Power Dissipation Curve

# MECHANICAL CASE OUTLINE PACKAGE DIMENSIONS



SCALE 2:1

SC-74  
CASE 318F  
ISSUE P

DATE 07 OCT 2021

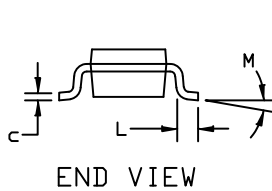
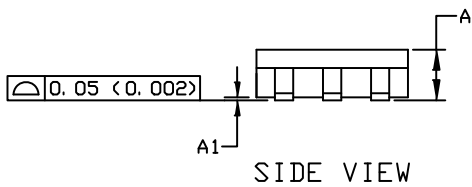

### GENERIC MARKING DIAGRAM\*

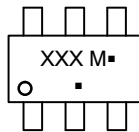

XXX = Specific Device Code  
M = Date Code  
▪ = Pb-Free Package

(Note: Microdot may be in either location)

\*This information is generic. Please refer to device data sheet for actual part marking. Pb-Free indicator, "G" or microdot "▪", may or may not be present. Some products may not follow the Generic Marking.

### NOTES:

1. DIMENSIONING AND TOLERANCING PER ASME Y14.5M, 1994
2. CONTROLLING DIMENSION: INCHES
3. MAXIMUM LEAD THICKNESS INCLUDES LEAD FINISH THICKNESS. MINIMUM LEAD THICKNESS IS THE MINIMUM THICKNESS OF THE BASE MATERIAL.

DIM	MILLIMETERS			INCHES		
	MIN.	NOM.	MAX.	MIN.	NOM.	MAX.
A	0.90	1.00	1.10	0.035	0.039	0.043
A1	0.01	0.06	0.10	0.001	0.002	0.004
b	0.25	0.37	0.50	0.010	0.015	0.020
c	0.10	0.18	0.26	0.004	0.007	0.010
D	2.90	3.00	3.10	0.114	0.118	0.122
E	1.30	1.50	1.70	0.051	0.059	0.067
e	0.85	0.95	1.05	0.034	0.037	0.041
HE	2.50	2.75	3.00	0.099	0.108	0.118
L	0.20	0.40	0.60	0.008	0.016	0.024
M	0*	---	10*	0*	---	10*

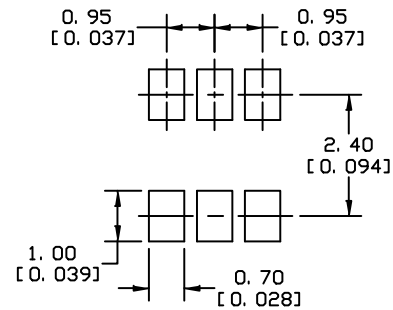

\* For additional information on our Pb-Free strategy and soldering details, please download the DN Semiconductor Soldering and Mounting Techniques Reference Manual, SOLDERM/D.

### SOLDERING FOOTPRINT

- |   |  |   |  |   |   |
|---|--|---|--|---|---|
| <p>STYLE 1:<br/>PIN 1. CATHODE<br/>2. ANODE<br/>3. CATHODE<br/>4. CATHODE<br/>5. ANODE<br/>6. CATHODE</p>     | <p>STYLE 2:<br/>PIN 1. NO CONNECTION<br/>2. COLLECTOR<br/>3. EMITTER<br/>4. NO CONNECTION<br/>5. COLLECTOR<br/>6. BASE</p> | <p>STYLE 3:<br/>PIN 1. EMITTER 1<br/>2. BASE 1<br/>3. COLLECTOR 2<br/>4. EMITTER 2<br/>5. BASE 2<br/>6. COLLECTOR 1</p> | <p>STYLE 4:<br/>PIN 1. COLLECTOR 2<br/>2. EMITTER 1/EMITTER 2<br/>3. COLLECTOR 1<br/>4. EMITTER 3<br/>5. BASE 1/BASE 2/COLLECTOR 3<br/>6. BASE 3</p> | <p>STYLE 5:<br/>PIN 1. CHANNEL 1<br/>2. ANODE<br/>3. CHANNEL 2<br/>4. CHANNEL 3<br/>5. CATHODE<br/>6. CHANNEL 4</p> | <p>STYLE 6:<br/>PIN 1. CATHODE<br/>2. ANODE<br/>3. CATHODE<br/>4. CATHODE<br/>5. CATHODE<br/>6. CATHODE</p> |
| <p>STYLE 7:<br/>PIN 1. SOURCE 1<br/>2. GATE 1<br/>3. DRAIN 2<br/>4. SOURCE 2<br/>5. GATE 2<br/>6. DRAIN 1</p> | <p>STYLE 8:<br/>PIN 1. EMITTER 1<br/>2. BASE 2<br/>3. COLLECTOR 2<br/>4. EMITTER 2<br/>5. BASE 1<br/>6. COLLECTOR 1</p>    | <p>STYLE 9:<br/>PIN 1. EMITTER 2<br/>2. BASE 2<br/>3. COLLECTOR 1<br/>4. EMITTER 1<br/>5. BASE 1<br/>6. COLLECTOR 2</p> | <p>STYLE 10:<br/>PIN 1. ANODE/CATHODE<br/>2. BASE<br/>3. EMITTER<br/>4. COLLECTOR<br/>5. ANODE<br/>6. CATHODE</p>                                    | <p>STYLE 11:<br/>PIN 1. EMITTER<br/>2. BASE<br/>3. ANODE/CATHODE<br/>4. ANODE<br/>5. CATHODE<br/>6. COLLECTOR</p>   |   |

DOCUMENT NUMBER:	98ASB42973B	Electronic versions are uncontrolled except when accessed directly from the Document Repository. Printed versions are uncontrolled except when stamped "CONTROLLED COPY" in red.
DESCRIPTION:	SC-74	PAGE 1 OF 1

onsemi and ONSEMI are trademarks of Semiconductor Components Industries, LLC dba onsemi or its subsidiaries in the United States and/or other countries. onsemi reserves the right to make changes without further notice to any products herein. onsemi makes no warranty, representation or guarantee regarding the suitability of its products for any particular purpose, nor does onsemi assume any liability arising out of the application or use of any product or circuit, and specifically disclaims any and all liability, including without limitation special, consequential or incidental damages. onsemi does not convey any license under its patent rights nor the rights of others.

**onsemi**, **Onsemi**, and other names, marks, and brands are registered and/or common law trademarks of Semiconductor Components Industries, LLC dba "**onsemi**" or its affiliates and/or subsidiaries in the United States and/or other countries. **onsemi** owns the rights to a number of patents, trademarks, copyrights, trade secrets, and other intellectual property. A listing of **onsemi**'s product/patent coverage may be accessed at [www.onsemi.com/site/pdf/Patent-Marking.pdf](http://www.onsemi.com/site/pdf/Patent-Marking.pdf). **onsemi** reserves the right to make changes at any time to any products or information herein, without notice. The information herein is provided "as-is" and **onsemi** makes no warranty, representation or guarantee regarding the accuracy of the information, product features, availability, functionality, or suitability of its products for any particular purpose, nor does **onsemi** assume any liability arising out of the application or use of any product or circuit, and specifically disclaims any and all liability, including without limitation special, consequential or incidental damages. Buyer is responsible for its products and applications using **onsemi** products, including compliance with all laws, regulations and safety requirements or standards, regardless of any support or applications information provided by **onsemi**. "Typical" parameters which may be provided in **onsemi** data sheets and/or specifications can and do vary in different applications and actual performance may vary over time. All operating parameters, including "Typicals" must be validated for each customer application by customer's technical experts. **onsemi** does not convey any license under any of its intellectual property rights nor the rights of others. **onsemi** products are not designed, intended, or authorized for use as a critical component in life support systems or any FDA Class 3 medical devices or medical devices with a same or similar classification in a foreign jurisdiction or any devices intended for implantation in the human body. Should Buyer purchase or use **onsemi** products for any such unintended or unauthorized application, Buyer shall indemnify and hold **onsemi** and its officers, employees, subsidiaries, affiliates, and distributors harmless against all claims, costs, damages, and expenses, and reasonable attorney fees arising out of, directly or indirectly, any claim of personal injury or death associated with such unintended or unauthorized use, even if such claim alleges that **onsemi** was negligent regarding the design or manufacture of the part. **onsemi** is an Equal Opportunity/Affirmative Action Employer. This literature is subject to all applicable copyright laws and is not for resale in any manner.

## PUBLICATION ORDERING INFORMATION

### LITERATURE FULFILLMENT:

Email Requests to: [orderlit@onsemi.com](mailto:orderlit@onsemi.com)

**onsemi Website:** [www.onsemi.com](http://www.onsemi.com)

### TECHNICAL SUPPORT

**North American Technical Support:**  
Voice Mail: 1 800-282-9855 Toll Free USA/Canada  
Phone: 011 421 33 790 2910

**Europe, Middle East and Africa Technical Support:**

Phone: 00421 33 790 2910

For additional information, please contact your local Sales Representative