



Is Now Part of



ON Semiconductor®

To learn more about ON Semiconductor, please visit our website at
www.onsemi.com

Please note: As part of the Fairchild Semiconductor integration, some of the Fairchild orderable part numbers will need to change in order to meet ON Semiconductor's system requirements. Since the ON Semiconductor product management systems do not have the ability to manage part nomenclature that utilizes an underscore (_), the underscore (_) in the Fairchild part numbers will be changed to a dash (-). This document may contain device numbers with an underscore (_). Please check the ON Semiconductor website to verify the updated device numbers. The most current and up-to-date ordering information can be found at www.onsemi.com. Please email any questions regarding the system integration to Fairchild_questions@onsemi.com.

ON Semiconductor and the ON Semiconductor logo are trademarks of Semiconductor Components Industries, LLC dba ON Semiconductor or its subsidiaries in the United States and/or other countries. ON Semiconductor owns the rights to a number of patents, trademarks, copyrights, trade secrets, and other intellectual property. A listing of ON Semiconductor's product/patent coverage may be accessed at www.onsemi.com/site/pdf/Patent-Marking.pdf. ON Semiconductor reserves the right to make changes without further notice to any products herein. ON Semiconductor makes no warranty, representation or guarantee regarding the suitability of its products for any particular purpose, nor does ON Semiconductor assume any liability arising out of the application or use of any product or circuit, and specifically disclaims any and all liability, including without limitation special, consequential or incidental damages. Buyer is responsible for its products and applications using ON Semiconductor products, including compliance with all laws, regulations and safety requirements or standards, regardless of any support or applications information provided by ON Semiconductor. "Typical" parameters which may be provided in ON Semiconductor data sheets and/or specifications can and do vary in different applications and actual performance may vary over time. All operating parameters, including "Typicals" must be validated for each customer application by customer's technical experts. ON Semiconductor does not convey any license under its patent rights nor the rights of others. ON Semiconductor products are not designed, intended, or authorized for use as a critical component in life support systems or any FDA Class 3 medical devices or medical devices with a same or similar classification in a foreign jurisdiction or any devices intended for implantation in the human body. Should Buyer purchase or use ON Semiconductor products for any such unintended or unauthorized application, Buyer shall indemnify and hold ON Semiconductor and its officers, employees, subsidiaries, affiliates, and distributors harmless against all claims, costs, damages, and expenses, and reasonable attorney fees arising out of, directly or indirectly, any claim of personal injury or death associated with such unintended or unauthorized use, even if such claim alleges that ON Semiconductor was negligent regarding the design or manufacture of the part. ON Semiconductor is an Equal Opportunity/Affirmative Action Employer. This literature is subject to all applicable copyright laws and is not for resale in any manner.



November 2014

MMBD1401A / MMBD1403A / MMBD1404A / MMBD1405A High-Voltage General-Purpose Diode

Descriptions

Sourced from process 2V.

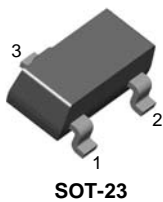

Connection Diagram

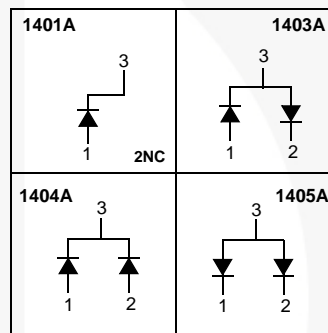

Ordering Information

Part Number	Top Mark	Package	Packing Method
MMBD1401A	A29	SOT-23 3L	Tape and Reel
MMBD1403A	A32	SOT-23 3L	Tape and Reel
MMBD1404A	A33	SOT-23 3L	Tape and Reel
MMBD1405A	A34	SOT-23 3L	Tape and Reel

MMBD1401A / MMBD1403A / MMBD1404A / MMBD1405A — High-Voltage General-Purpose Diode

Absolute Maximum Ratings^{(1), (2)}

Stresses exceeding the absolute maximum ratings may damage the device. The device may not function or be operable above the recommended operating conditions and stressing the parts to these levels is not recommended. In addition, extended exposure to stresses above the recommended operating conditions may affect device reliability. The absolute maximum ratings are stress ratings only. Values are at $T_A = 25^\circ\text{C}$ unless otherwise noted.

Symbol	Parameter	Value	Unit
W_{IV}	Working Inverse Voltage	175	V
I_O	Average Rectified Current	200	mA
I_F	DC Forward Current	600	mA
i_f	Recurrent Peak Forward Current	700	mA
$i_{f(\text{surge})}$	Non-Repetitive Peak Forward Surge Current	Pulse Width = 1.0 second	1.0
		Pulse Width = 1.0 microsecond	2.0
T_{STG}	Storage Temperature Range	-55 to +150	$^\circ\text{C}$
T_J	Operating Junction Temperature	150	$^\circ\text{C}$

Notes:

- These ratings are based on a maximum junction temperature of 150°C .
- These are steady-state limits. Fairchild Semiconductor should be consulted on applications involving pulsed or low-duty-cycle operations.

Thermal Characteristics⁽³⁾

Values are at $T_A = 25^\circ\text{C}$ unless otherwise noted.

Symbol	Parameter	Max.	Unit
P_D	Power Dissipation	350	mW
	Derate above 25°C	2.8	mW/ $^\circ\text{C}$
$R_{\theta JA}$	Thermal Resistance, Junction-to-Ambient	357	$^\circ\text{C}/\text{W}$

Note:

- Device is mounted on glass epoxy PCB 1.6 inch x 1.6 inch x 0.06 inch, mounting pad for the collector lead minimum 0.93 in^2 .

Electrical Characteristics

Values are at $T_A = 25^\circ\text{C}$ unless otherwise noted.

Symbol	Parameter	Conditions	Min.	Max.	Unit
B_V	Breakdown Voltage	$I_R = 100\ \mu\text{A}$	250		V
I_R	Reverse Current	$V_R = 120\ \text{V}$		40	nA
		$V_R = 175\ \text{V}$		100	nA
V_F	Forward Voltage	$I_F = 10\ \text{mA}$		800	mV
		$I_F = 50\ \text{mA}$	760	920	mV
		$I_F = 200\ \text{mA}$		1.1	V
		$I_F = 300\ \text{mA}$		1.25	V
C_O	Diode Capacitance	$V_R = 0, f = 1.0\ \text{MHz}$		2.0	pF
T_{RR}	Reverse Recovery Time	$I_F = I_R = 30\ \text{mA}$, $I_{RR} = 1.0\ \text{mA}, R_L = 100\ \Omega$		50	nS

Typical Performance Characteristics

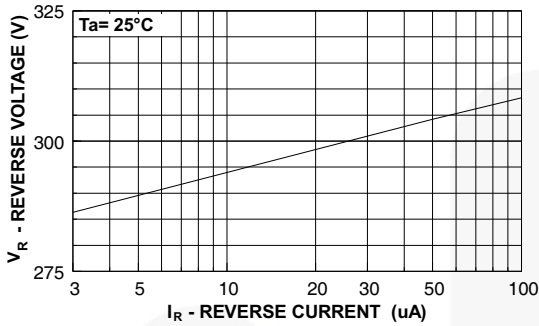

Figure 1. Reverse Voltage vs. Reverse Current
BV - 1.0 to 100 μ A

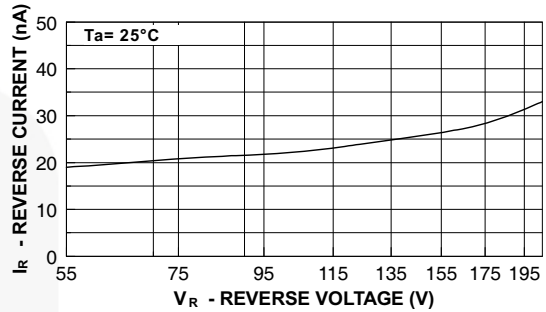

Figure 2. Reverse Current vs. Reverse Voltage
 I_R - 55 to 205 V

GENERAL RULE: The Reverse Current of a diode will approximately double for every ten (10) Degree C increase in Temperature

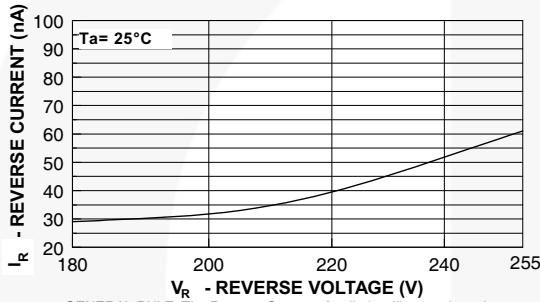

Figure 3. Reverse Current vs. Reverse Voltage
 I_R - 180 to 255 V

GENERAL RULE: The Reverse Current of a diode will approximately double for every ten Degree C increase in Temperature

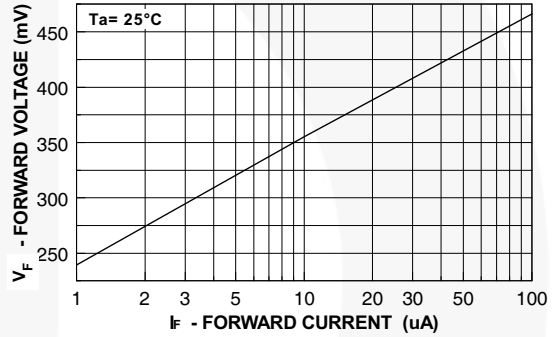

Figure 4. Forward Voltage vs. Forward Current
 V_F - 1.0 to 100 μ A

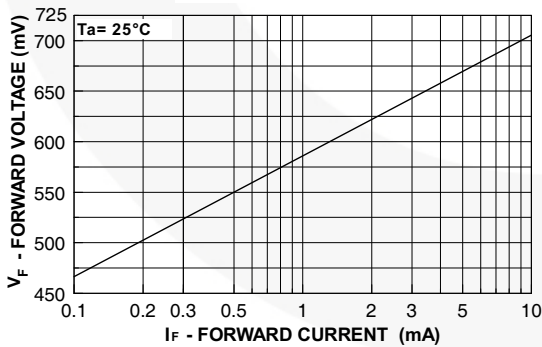

Figure 5. Forward Voltage vs. Forward Current
 V_F - 0.1 to 10 mA

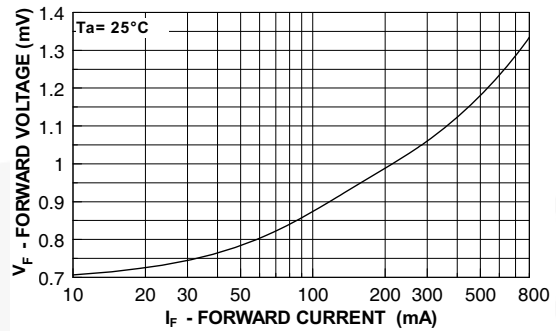

Figure 6. Forward Voltage vs. Forward Current
 V_F - 10 to 800 mA

Typical Performance Characteristics (Continued)

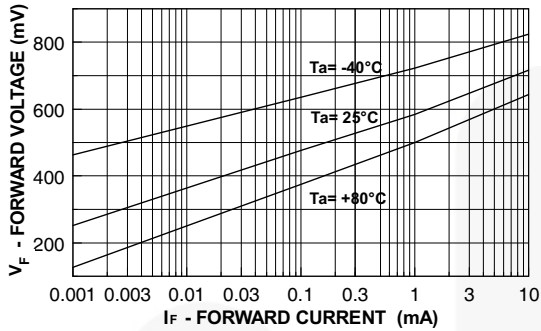

Figure 7. Forward Voltage vs. Ambient Temperature
 V_F - 1.0 μ A - 10 mA (- 40 to +80°C)

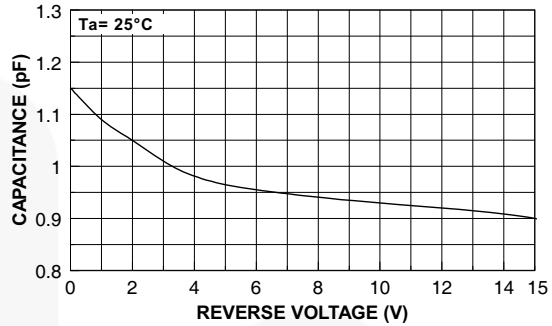

Figure 8. Capacitance vs. Reverse Voltage

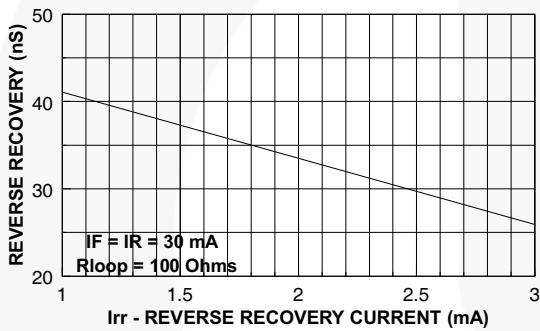

Figure 9. Reverse Recovery Time vs. Reverse Recovery Current (I_{rr})

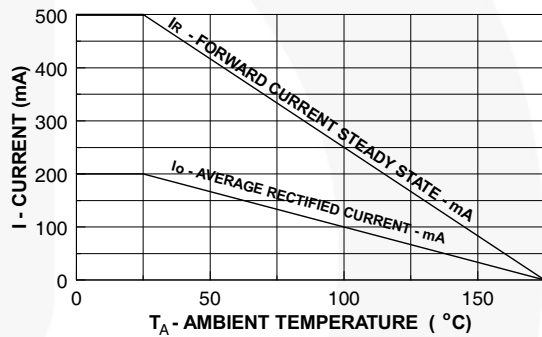

Figure 10. Average Rectified Current (I_O) and Forward Current (I_F) vs. Ambient Temperature (T_A)

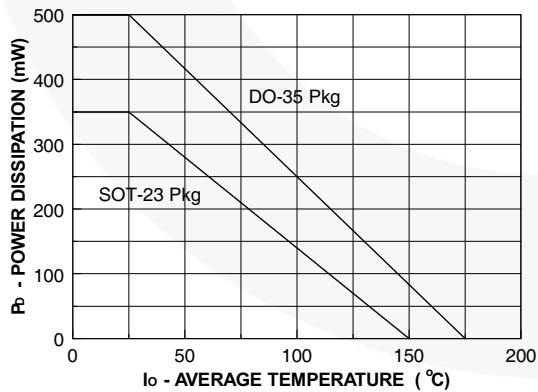
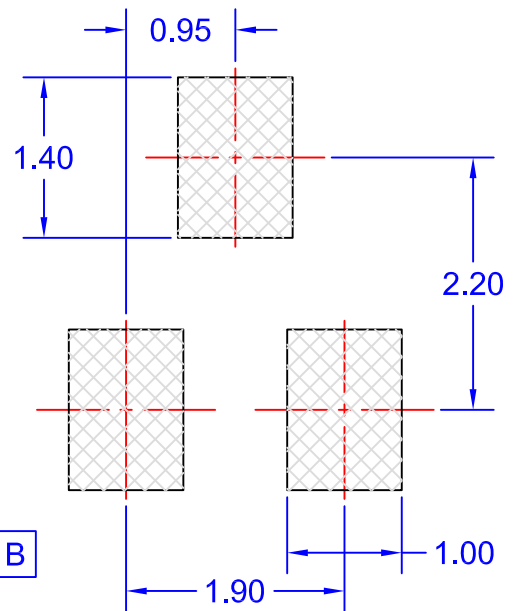
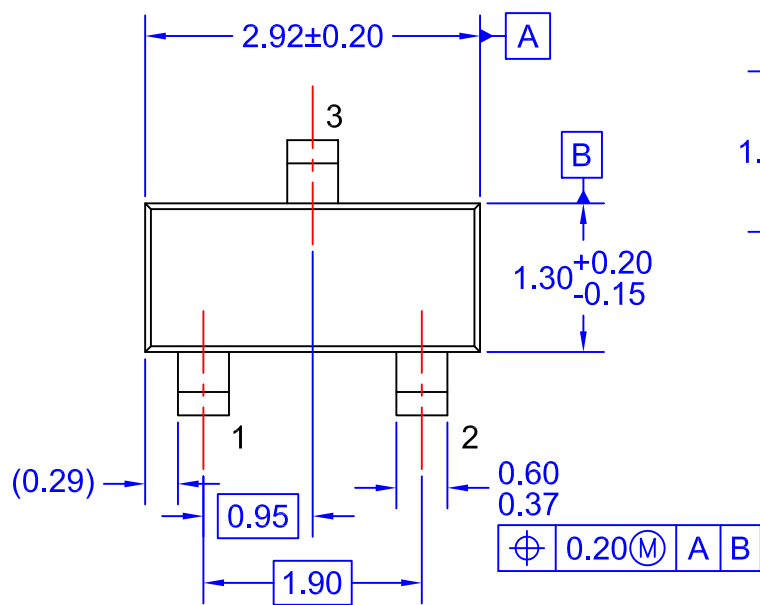
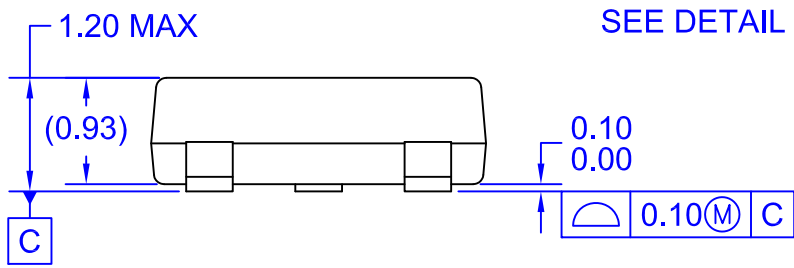

Figure 11. Power Derating Curve



LAND PATTERN
RECOMMENDATION



SEE DETAIL A

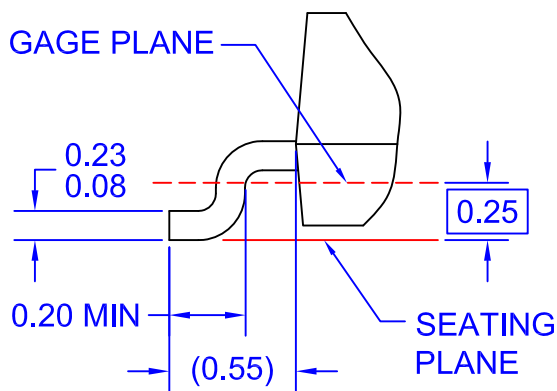
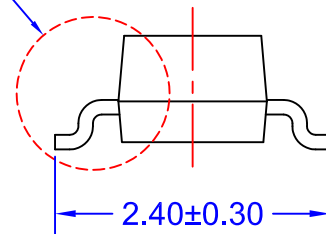

DETAIL A
SCALE: 2X

NOTES: UNLESS OTHERWISE SPECIFIED

- A) REFERENCE JEDEC REGISTRATION TO-236, VARIATION AB, ISSUE H.
- B) ALL DIMENSIONS ARE IN MILLIMETERS.
- C) DIMENSIONS ARE INCLUSIVE OF BURRS, MOLD FLASH AND TIE BAR EXTRUSIONS.
- D) DIMENSIONING AND TOLERANCING PER ASME Y14.5M - 2009.
- E) DRAWING FILE NAME: MA03DREV12



ON Semiconductor and  are trademarks of Semiconductor Components Industries, LLC dba ON Semiconductor or its subsidiaries in the United States and/or other countries. ON Semiconductor owns the rights to a number of patents, trademarks, copyrights, trade secrets, and other intellectual property. A listing of ON Semiconductor's product/patent coverage may be accessed at www.onsemi.com/site/pdf/Patent-Marking.pdf. ON Semiconductor reserves the right to make changes without further notice to any products herein. ON Semiconductor makes no warranty, representation or guarantee regarding the suitability of its products for any particular purpose, nor does ON Semiconductor assume any liability arising out of the application or use of any product or circuit, and specifically disclaims any and all liability, including without limitation special, consequential or incidental damages. Buyer is responsible for its products and applications using ON Semiconductor products, including compliance with all laws, regulations and safety requirements or standards, regardless of any support or applications information provided by ON Semiconductor. "Typical" parameters which may be provided in ON Semiconductor data sheets and/or specifications can and do vary in different applications and actual performance may vary over time. All operating parameters, including "Typicals" must be validated for each customer application by customer's technical experts. ON Semiconductor does not convey any license under its patent rights nor the rights of others. ON Semiconductor products are not designed, intended, or authorized for use as a critical component in life support systems or any FDA Class 3 medical devices or medical devices with a same or similar classification in a foreign jurisdiction or any devices intended for implantation in the human body. Should Buyer purchase or use ON Semiconductor products for any such unintended or unauthorized application, Buyer shall indemnify and hold ON Semiconductor and its officers, employees, subsidiaries, affiliates, and distributors harmless against all claims, costs, damages, and expenses, and reasonable attorney fees arising out of, directly or indirectly, any claim of personal injury or death associated with such unintended or unauthorized use, even if such claim alleges that ON Semiconductor was negligent regarding the design or manufacture of the part. ON Semiconductor is an Equal Opportunity/Affirmative Action Employer. This literature is subject to all applicable copyright laws and is not for resale in any manner.

PUBLICATION ORDERING INFORMATION

LITERATURE FULFILLMENT:

Literature Distribution Center for ON Semiconductor
19521 E. 32nd Pkwy, Aurora, Colorado 80011 USA
Phone: 303-675-2175 or 800-344-3860 Toll Free USA/Canada
Fax: 303-675-2176 or 800-344-3867 Toll Free USA/Canada
Email: orderlit@onsemi.com

N. American Technical Support: 800-282-9855 Toll Free
USA/Canada
Europe, Middle East and Africa Technical Support:
Phone: 421 33 790 2910
Japan Customer Focus Center
Phone: 81-3-5817-1050

ON Semiconductor Website: www.onsemi.com
Order Literature: <http://www.onsemi.com/orderlit>
For additional information, please contact your local
Sales Representative