

# NCV8452

## Self Protected High Side Driver with Temperature Shutdown and Current Limit

The NCV8452 is a fully protected High-Side driver that can be used to switch a wide variety of loads, such as bulbs, solenoids and other activators. The device is internally protected from an overload condition by an active current limit and thermal shutdown.

### Features

- Short Circuit Protection
- Thermal Shutdown with Automatic Restart
- CMOS (3 V/5 V) Compatible Control Input
- Overvoltage Protection and Shutdown
- Output Voltage Clamp for Inductive Switching
- Under Voltage Shutdown
- Loss of Ground Protection
- ESD Protection
- Reverse Battery Protection (with external resistor)
- Very Low Standby Current
- NCV Prefix for Automotive and Other Applications Requiring Unique Site and Control Change Requirements; AEC-Q101 Qualified and PPAP Capable
- These Devices are Pb-Free, Halogen Free/BFR Free and are RoHS Compliant

### Typical Applications

- Switch a Variety of Resistive, Inductive and Capacitive Loads
- Can Replace Electromechanical Relays and Discrete Circuits
- Automotive / Industrial

### PRODUCT SUMMARY

Symbol	Characteristics	Value	Unit
$V_{OV}$	Overvoltage Protection	41	V
$V_D$	Operation Voltage	5 – 34	V
$R_{ON}$	On-State Resistance	200	m $\Omega$
$I_{ILIM}$	Output Current Limit	1.0	A



ON Semiconductor®

[www.onsemi.com](http://www.onsemi.com)

### MARKING DIAGRAM



SOT-223  
(TO-261)  
CASE 318E

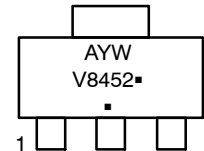

V8452 = Device Code  
A = Assembly Location  
Y = Year  
W = Work Week  
▪ = Pb-Free Package

(Note: Microdot may be in either location)

### ORDERING INFORMATION

See detailed ordering and shipping information in the package dimensions section on page 12 of this data sheet.



# NCV8452

## MAXIMUM RATINGS

Rating	Symbol	Value	Unit
DC Supply Voltage	$V_D$	40	V
Peak Transient Input Voltage (Load Dump 37.5 V, $V_D = 13.5$ V, ISO7637-2 pulse5) (Note 1)	$V_{peak}$	51	V
Input Voltage	$V_{IN}$	-5 to $V_D$	V
Input Current	$I_{IN}$	$\pm 5$	mA
Output Current	$I_{OUT}$	Internally Limited	A
Power Dissipation @ $T_A = 25^\circ\text{C}$ (Note 3) @ $T_A = 25^\circ\text{C}$ (Note 4)	$P_D$	1.19 1.76	W
Electrostatic Discharge (Note 1) (HBM Model 100 pF / 1500 $\Omega$ ) Input Output $V_D$		$\pm 1$ $\pm 5$ $\pm 5$	kV
Single Pulse Inductive Load Switch Off Energy (Note 1) ( $L = 4.55$ H, $V_D = 13.5$ V; $I_L = 0.5$ A, $T_{Jstart} = 25^\circ\text{C}$ )	$E_{AS}$	0.8	J
Operating Junction Temperature	$T_J$	-40 to +150	$^\circ\text{C}$
Storage Temperature	$T_{storage}$	-55 to +150	$^\circ\text{C}$

Stresses exceeding those listed in the Maximum Ratings table may damage the device. If any of these limits are exceeded, device functionality should not be assumed, damage may occur and reliability may be affected.

1. Not subjected to production testing
2. Reverse Output current has to be limited by the load to stay within absolute maximum ratings and thermal performance.
3. Minimum pad.
4. 1 in square pad size, FR-4, 1 oz Cu.

## THERMAL RESISTANCE RATINGS

Parameter	Symbol	Max Value	Unit
Thermal Resistance (Note 5) Junction-to-Soldering Point	$R_{thJS}$	10	$^\circ\text{C/W}$
Junction-to-Ambient (Note 6)	$R_{thJA}$	105	$^\circ\text{C/W}$
Junction-to-Ambient (Note 7)	$R_{thJA}$	71	$^\circ\text{C/W}$

5. Reverse Output current has to be limited by the load to stay within absolute maximum ratings and thermal performance.
6. Minimum pad.
7. 1 in square pad size, FR-4, 1 oz Cu.

# NCV8452

## ELECTRICAL CHARACTERISTICS ( $V_D = 13.5\text{ V}$ ; $-40^\circ\text{C} < T_J < 150^\circ\text{C}$ unless otherwise specified)

Rating	Symbol	Conditions	Value			Unit
			Min	Typ	Max	
Operating Supply Voltage	$V_D$		5	–	34	V
Undervoltage Shutdown	$V_{UV}$		2.5		5.5	V
Undervoltage Restart	$V_{UV(res)}$				6.0	V
Undervoltage Hysteresis	$V_{UV(hyst)}$			0.3		
Overvoltage Shutdown	$V_{OV}$		34		42	V
Overvoltage Restart	$V_{OV(res)}$		33			
On-state Resistance	$R_{ON}$	$I_{OUT} = 0.5\text{ A}$ , $V_{IN} = 5\text{ V}$ , $T_J = 25^\circ\text{C}$ $I_{OUT} = 0.5\text{ A}$ , $V_{IN} = 5\text{ V}$ , $T_J = 150^\circ\text{C}$		160 –	200 400	m $\Omega$
Standby Current	$I_{D(off)}$	$V_{IN} = V_{OUT} = 0\text{ V}$		12	25	$\mu\text{A}$
Active Ground Current	$I_{GND(on)}$	$V_{IN} = 5\text{ V}$		1	1.8	mA
Output Leakage Current	$I_{OUT(off)}$	$V_{IN} = 0\text{ V}$			2	$\mu\text{A}$

### INPUT CHARACTERISTICS

Input Voltage – Low	$V_{IN(low)}$				0.8	V
Input Voltage – High	$V_{IN(high)}$		2.2			V
Off State Input Current	$I_{IN(off)}$	$V_{IN} = 0.7\text{ V}$			10	$\mu\text{A}$
On State Input Current	$I_{IN(on)}$	$V_{IN} = 5.0\text{ V}$			10	$\mu\text{A}$
Input Threshold Hysteresis	$V_{IN(hyst)}$			0.3		V
Input Resistance	$R_I$		1.5	2.8	3.5	k $\Omega$

### SWITCHING CHARACTERISTICS

Turn-On Time	$t_{on}$	to 90% $V_{OUT}$ , $R_L = 24\ \Omega$		60	120	$\mu\text{s}$
Turn-Off Time	$t_{off}$	to 10% $V_{OUT}$ , $R_L = 24\ \Omega$		60	120	$\mu\text{s}$
Slew Rate On	$dV_{OUT}/dt_{on}$	10% to 30% $V_{OUT}$ , $R_L = 24\ \Omega$		1	4	V / $\mu\text{s}$
Slew Rate Off	$dV_{OUT}/dt_{off}$	70% to 40% $V_{OUT}$ , $R_L = 24\ \Omega$		1	4	V / $\mu\text{s}$

### REVERSE BATTERY (Note 8)

Reverse Battery	$-V_D$	Requires a 150 $\Omega$ Resistor in GND Connection			32	V
Forward Voltage	$V_F$	$T_J = 150^\circ\text{C}$		0.6		V

### PROTECTION FUNCTIONS (Note 9)

Temperature Shutdown (Note 8)	TSD		150	175	200	$^\circ\text{C}$
Temperature Shutdown Hysteresis (Note 8)	TSD <sub>(hyst)</sub>			10		$^\circ\text{C}$
Overvoltage Protection	$V_{OV}$	$I_D = 4\text{ mA}$	41			V
Switch Off Output Clamp Voltage	$V_{CLAMP}$	$I_D = 4\text{ mA}$ , $V_{IN} = 0\text{ V}$	$V_D - 41$	$V_D - 47$		V
Output Current Limit Initial Peak	$I_{LIM}$	$V_D = 20\text{ V}$ , $T_J = 25^\circ\text{C}$ $T_J = -40^\circ\text{C}$ to $150^\circ\text{C}$	1.0	1.8 –	3	A

8. Not subjected to production testing

9. To ensure long term reliability under heavy overload or short circuit conditions, protection and related diagnostic signals must be used together with a proper hardware/software strategy. If the devices operates under abnormal conditions this hardware/software solutions must limit the duration and number of activation cycles.

# NCV8452

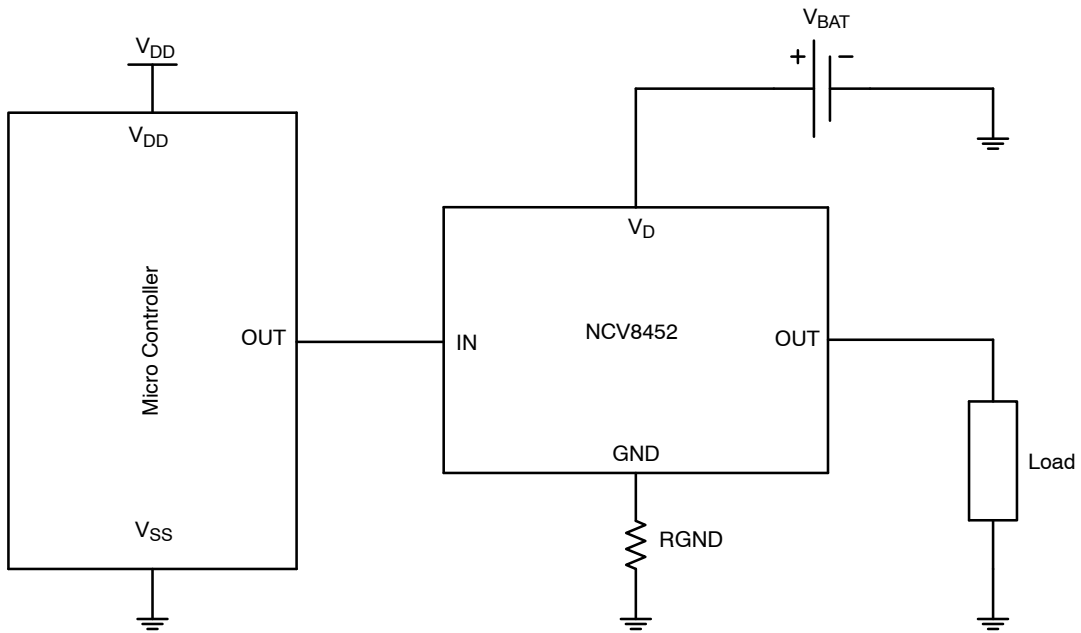

Figure 3. Application Diagram

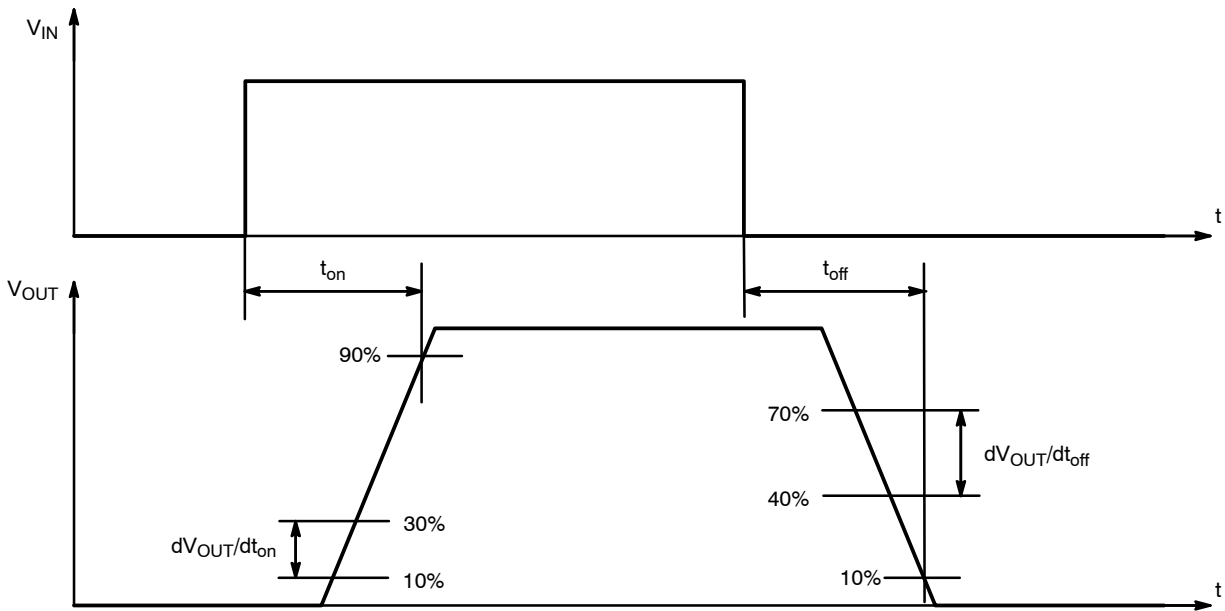

Figure 4. Resistive Load Switching Waveform

TYPICAL CHARACTERISTIC CURVES

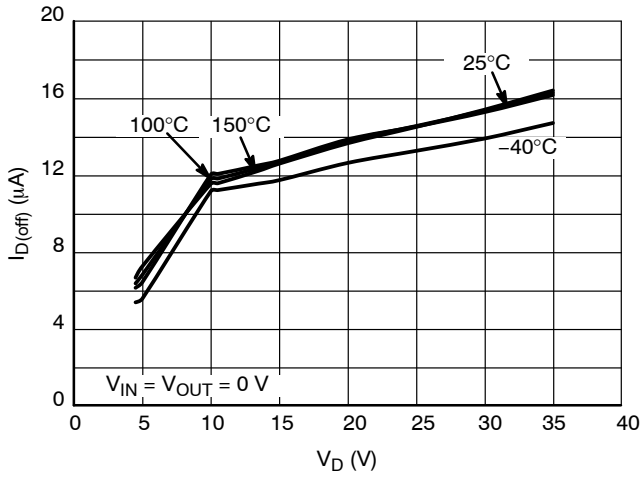

Figure 5. Standby Current vs. Supply Voltage

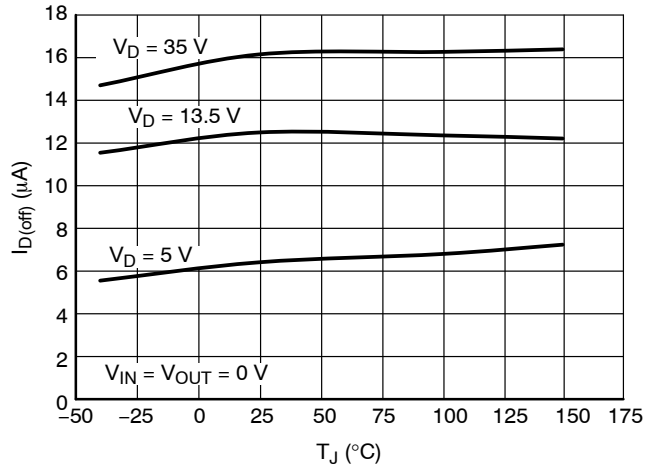

Figure 6. Standby Current vs. Junction Temperature

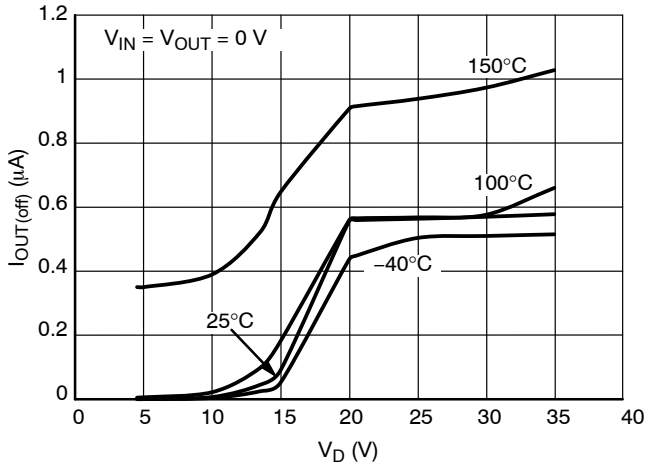

Figure 7. Output Leakage Current vs. Supply Voltage

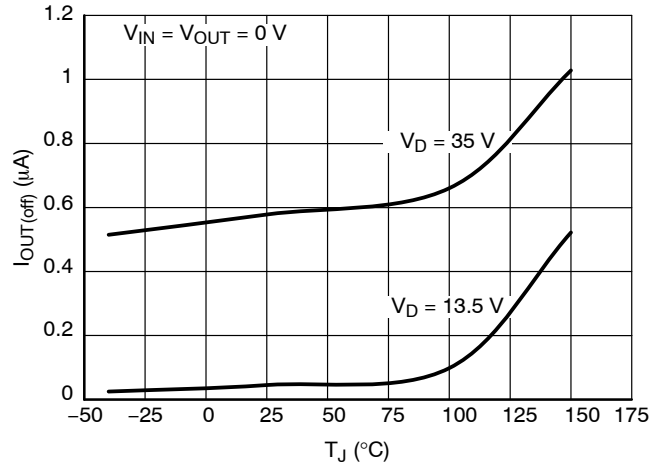

Figure 8. Output Leakage Current vs. Junction Temperature

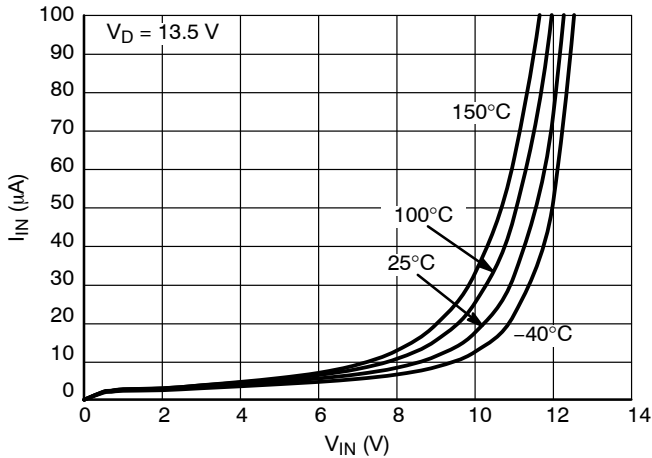

Figure 9. Input Current vs. Input Voltage

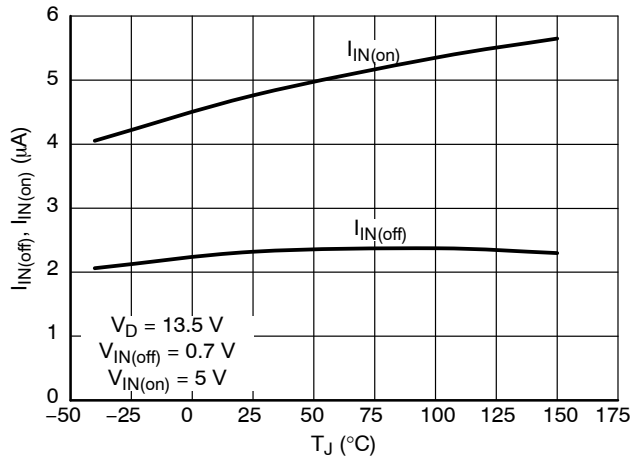

Figure 10. Input Current vs. Junction Temperature

TYPICAL CHARACTERISTIC CURVES

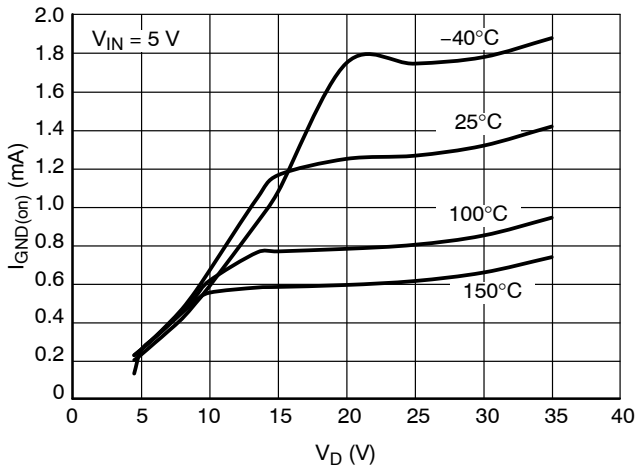

Figure 11. Active Ground Current vs. Supply Voltage

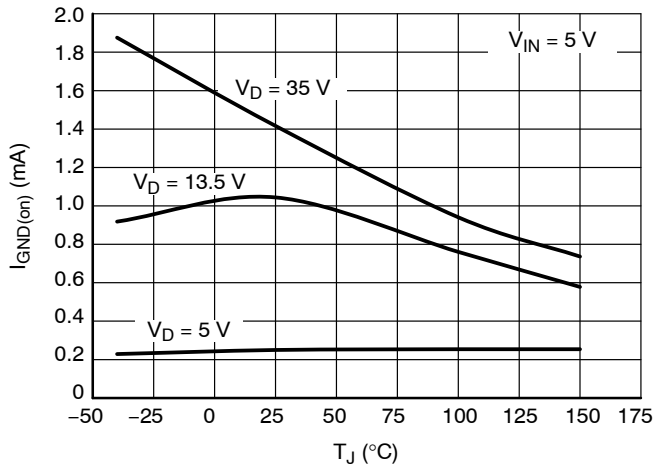

Figure 12. Active Ground Current vs. Junction Temperature

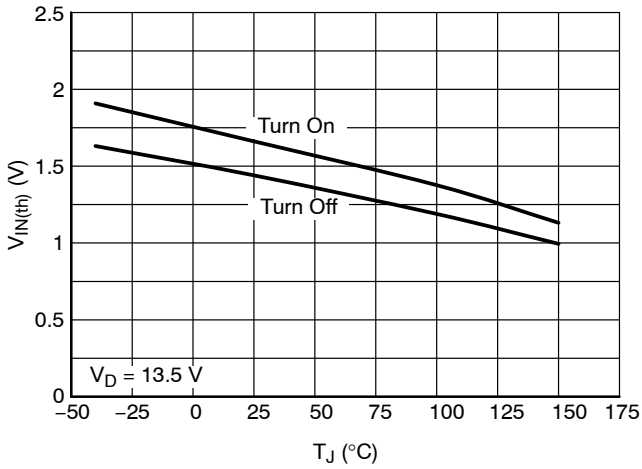

Figure 13. Input Threshold Voltage vs. Junction Temperature

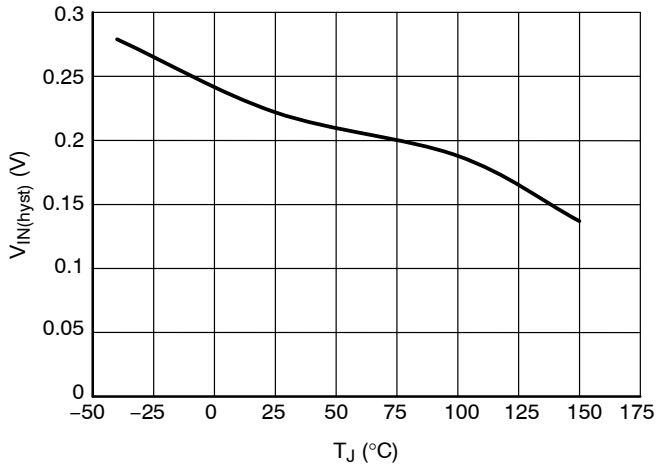

Figure 14. Input Threshold Hysteresis vs. Junction Temperature

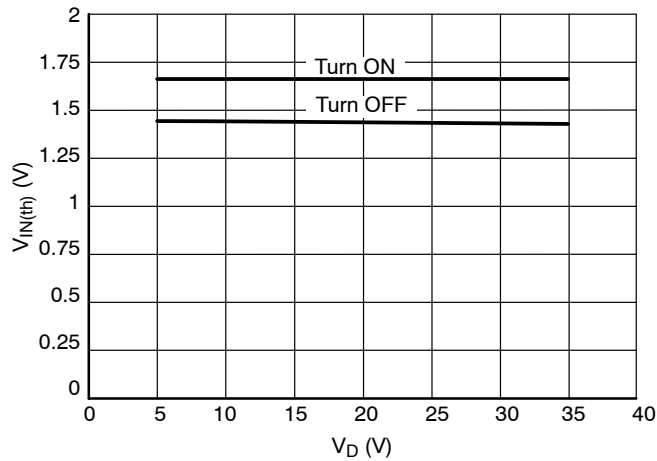

Figure 15. Input Threshold Voltage vs. Supply Voltage

TYPICAL CHARACTERISTIC CURVES

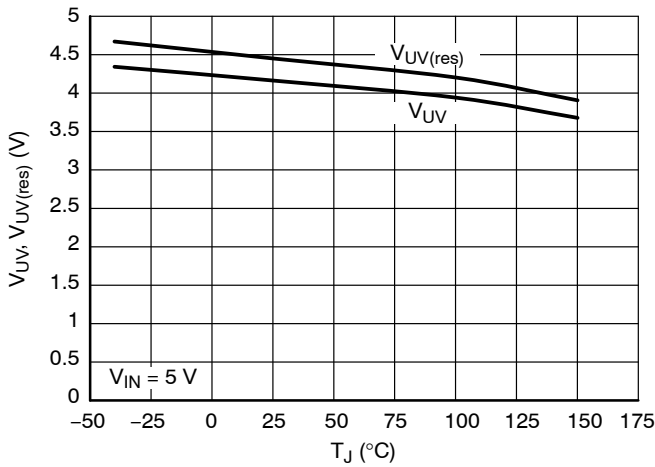

Figure 16. Under Voltage Shutdown and Restart vs. Junction Temperature

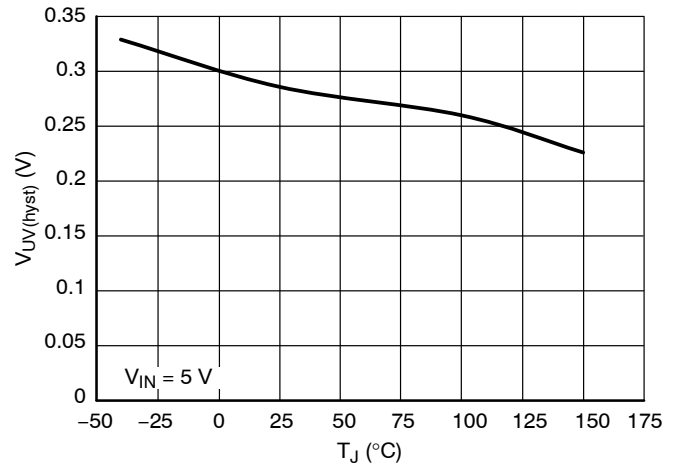

Figure 17. Under Voltage Shutdown Hysteresis vs. Junction Temperature

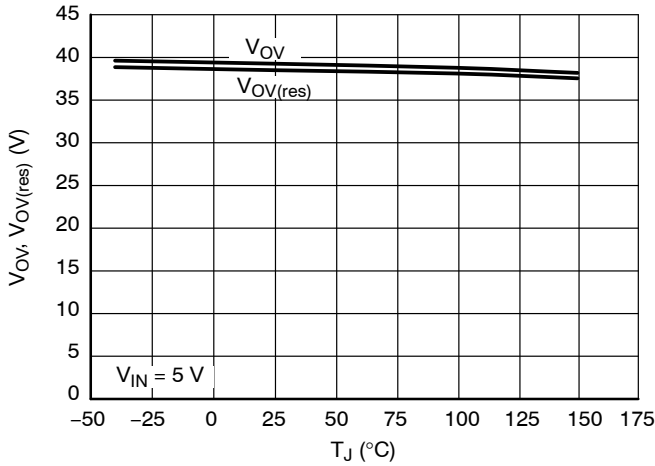

Figure 18. Over Voltage Shutdown vs. Junction Temperature

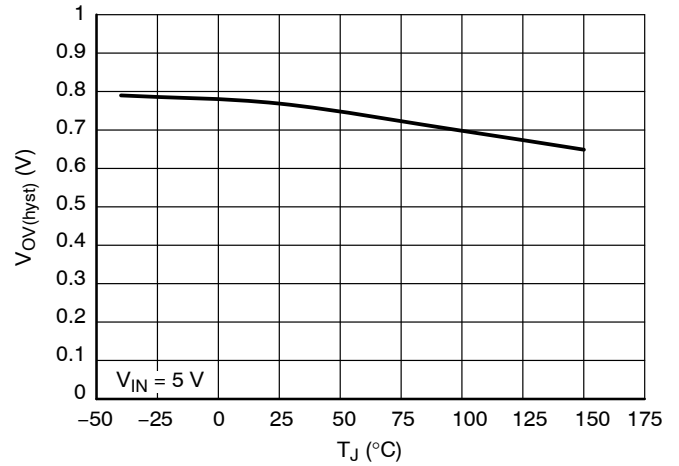

Figure 19. Over Voltage Shutdown Hysteresis vs. Junction Temperature

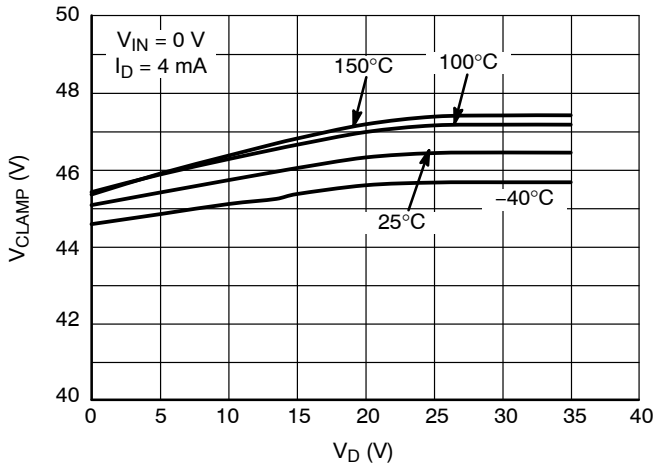

Figure 20. Output Clamp Voltage vs. Supply Voltage

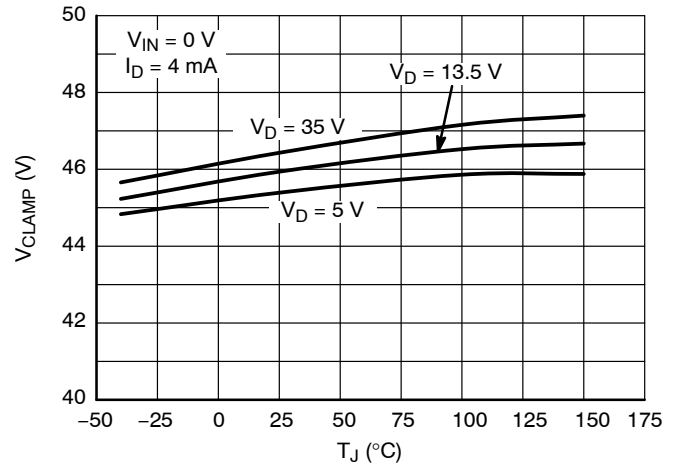

Figure 21. Output Clamp Voltage vs. Junction Temperature



TYPICAL CHARACTERISTIC CURVES

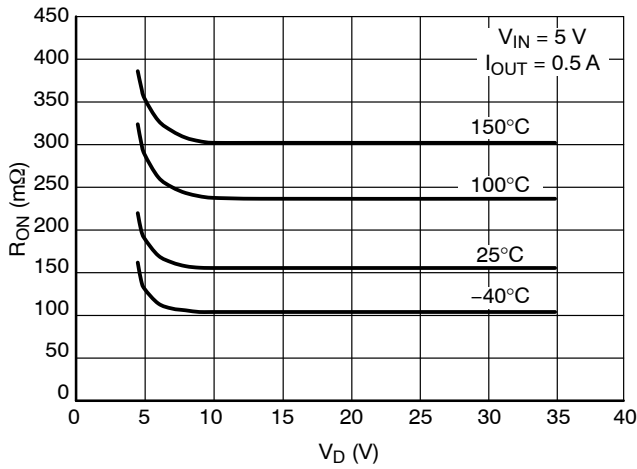

Figure 22. On-state Resistance vs. Supply Voltage

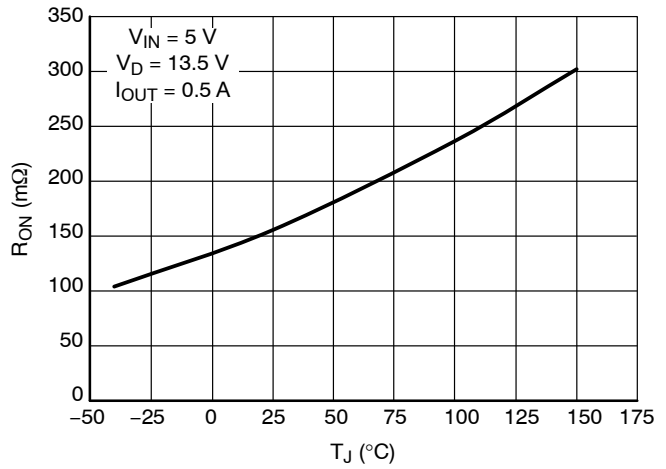

Figure 23. On-state Resistance vs. Junction Temperature

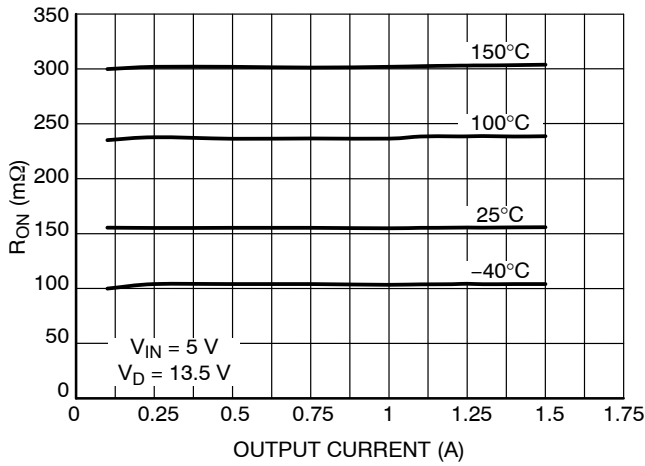

Figure 24. On-state Resistance vs. Output Current

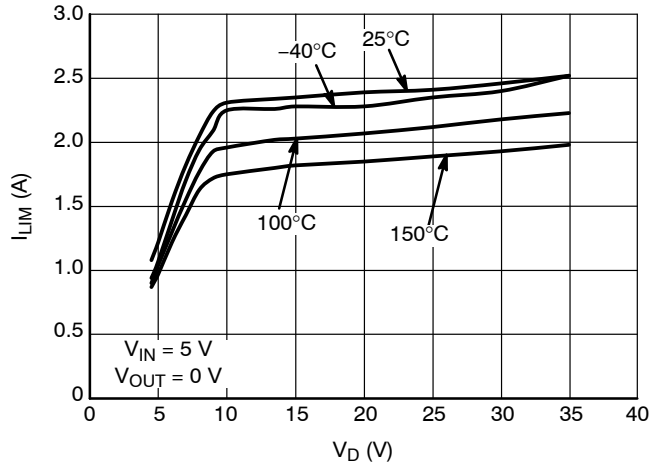

Figure 25. Current Limit vs. Supply Voltage

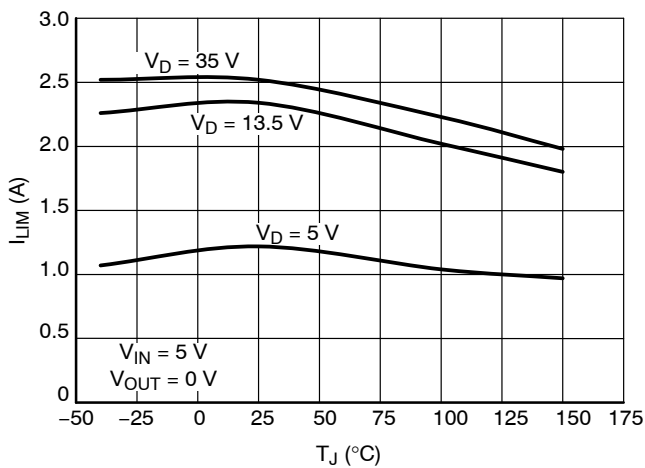

Figure 26. Current Limit vs. Junction Temperature

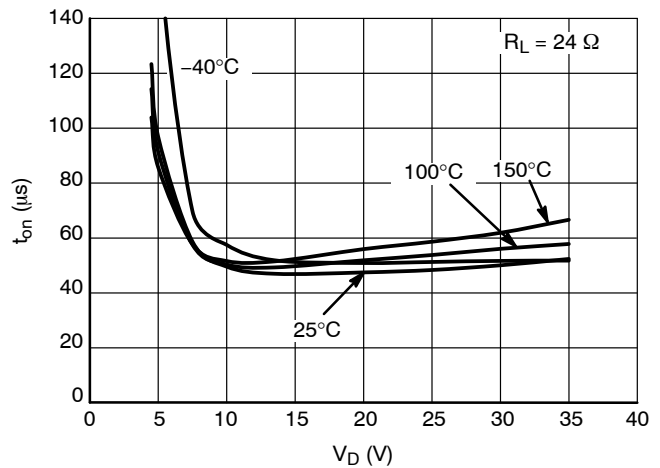

Figure 27. Turn-On Time vs. Supply Voltage

TYPICAL CHARACTERISTIC CURVES

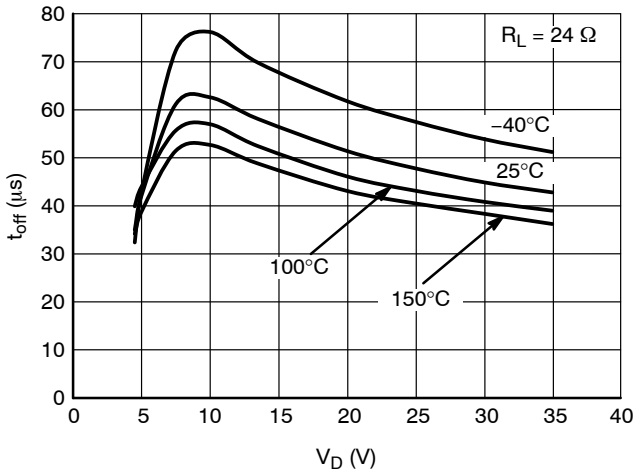

Figure 28. Turn-Off Time vs. Supply Voltage

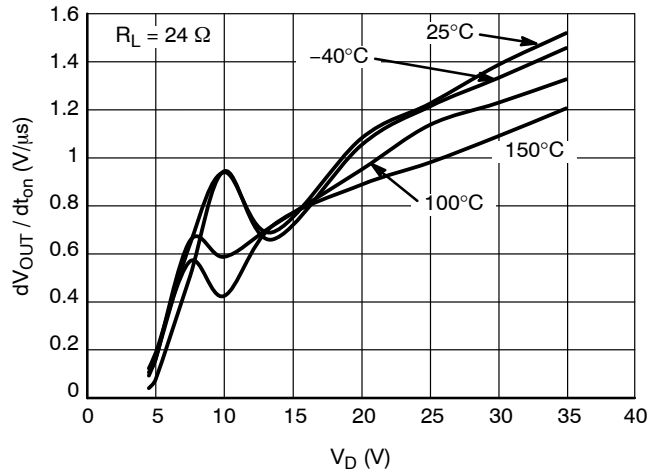

Figure 29. Slew Rate On vs. Supply Voltage

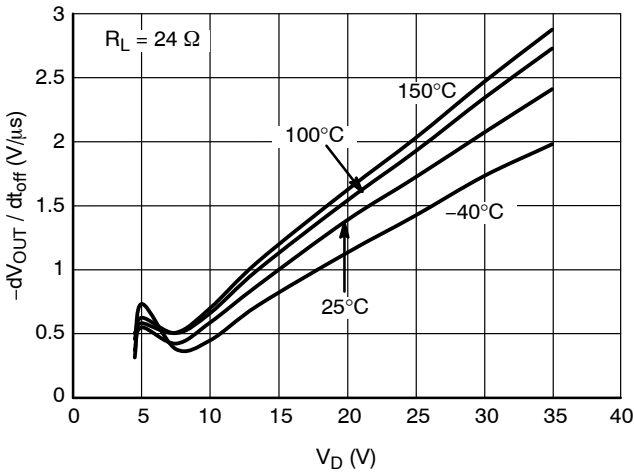

Figure 30. Slew Rate Off vs. Supply Voltage

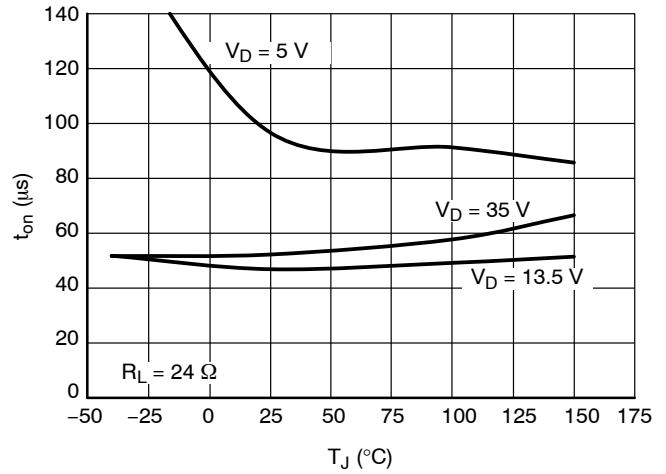

Figure 31. Turn-On vs. Junction Temperature

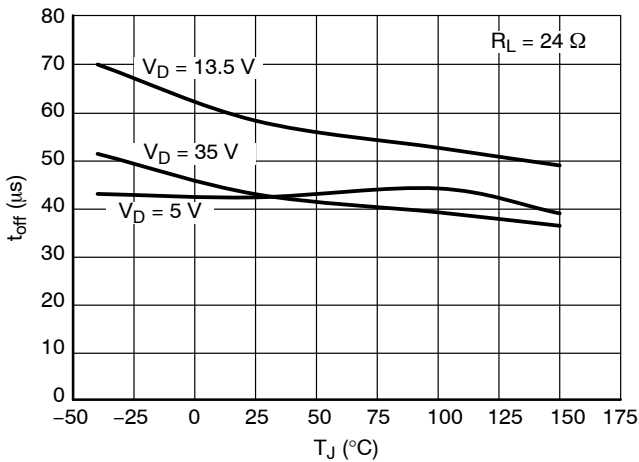

Figure 32. Turn-Off Time vs. Junction Temperature

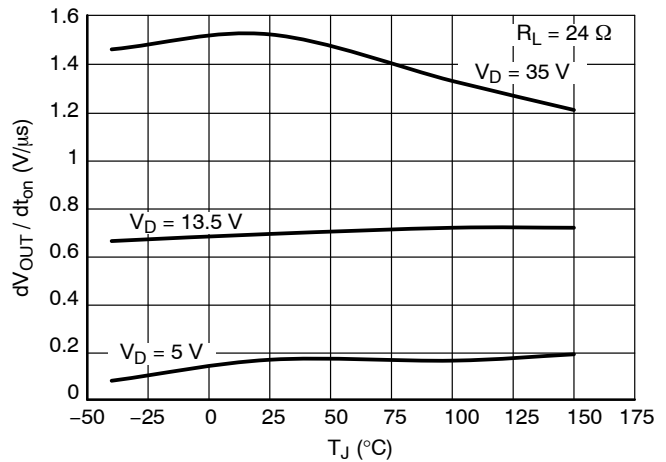

Figure 33. Slew Rate On vs. Junction Temperature

TYPICAL CHARACTERISTIC CURVES

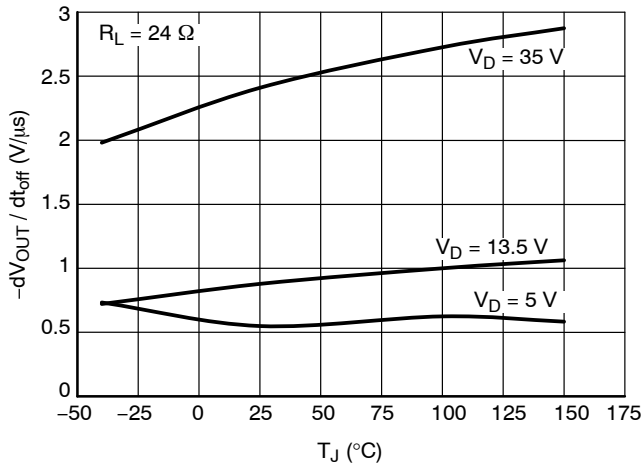

Figure 34. Slew Rate Off vs. Junction Temperature

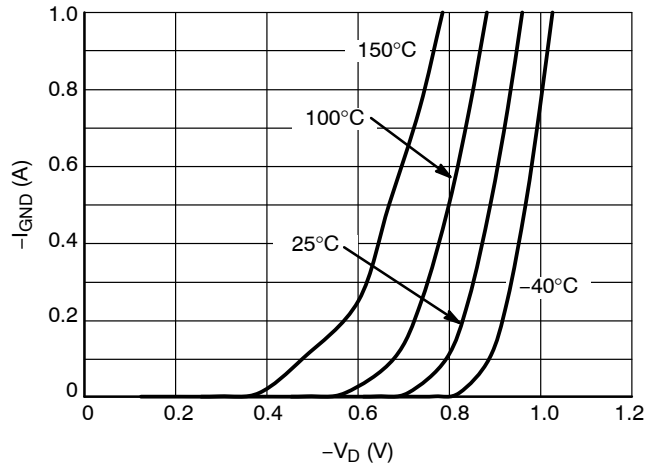

Figure 35. Supply-to-Ground Reverse Characteristics

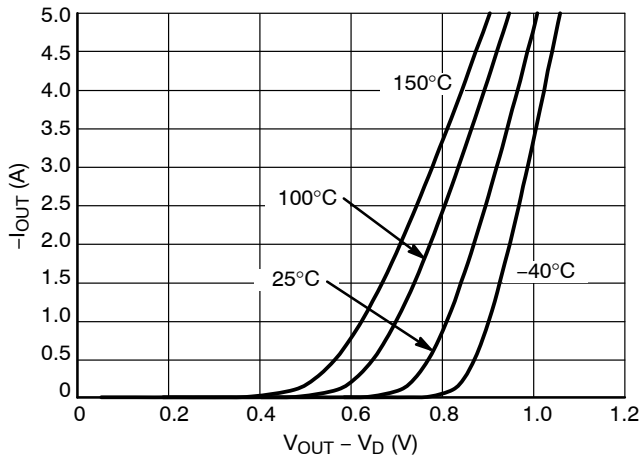

Figure 36. Power FET Body Forward Characteristics

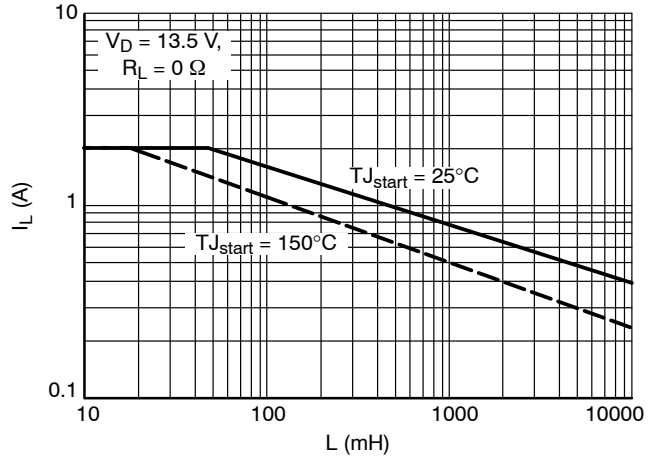

Figure 37. Single Pulse Maximum Switch Off Current vs. Load Inductance

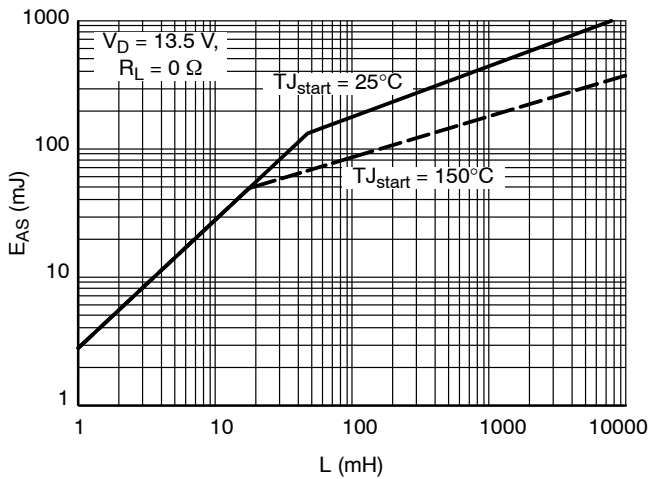

Figure 38. Single Pulse Maximum Switch Off Energy vs. Load Inductance

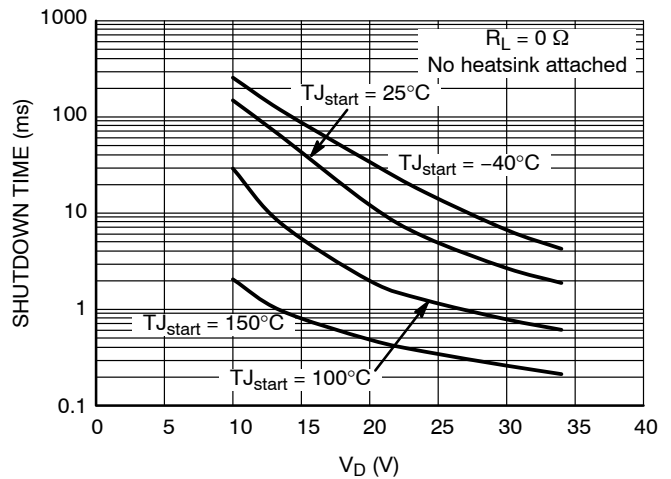
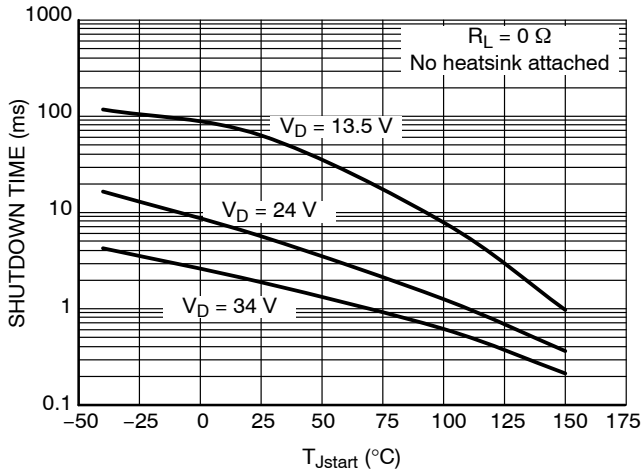
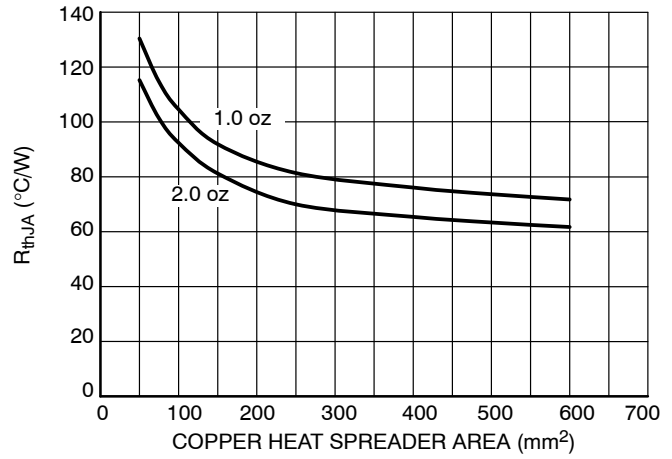

Figure 39. Initial Short-Circuit Shutdown Time vs. Supply Voltage

# NCV8452



**Figure 40. Initial Short-Circuit Shutdown Time vs. Starting Junction Temperature**



**Figure 41. Junction-to-Ambient Thermal Resistance vs. Copper Area**

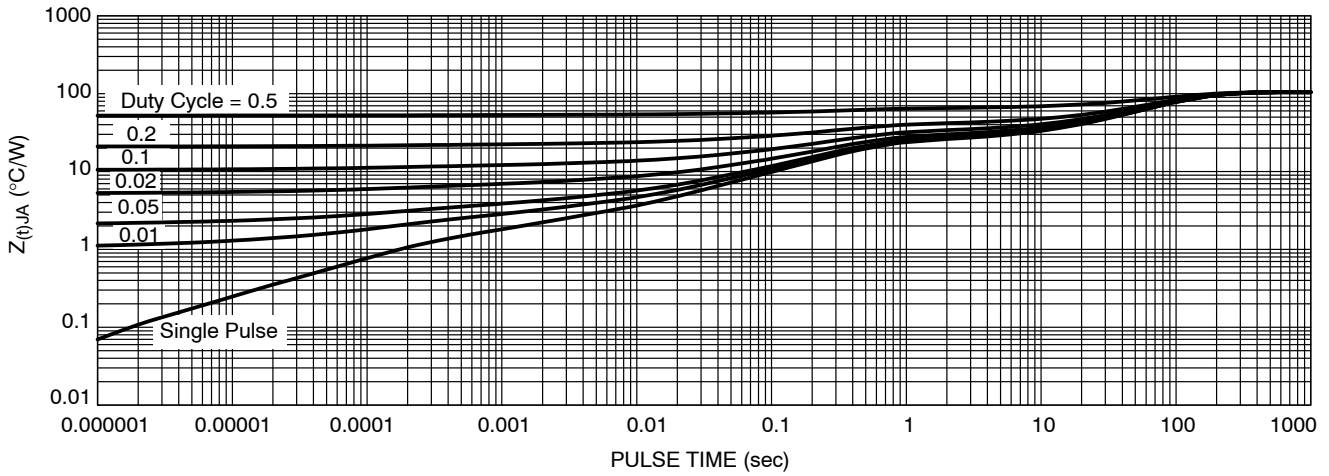

**Figure 42. Junction-to-Ambient Transient Thermal Impedance (minimum pad size)**

## ORDERING INFORMATION

Device	Package	Shipping <sup>†</sup>
NCV8452STT1G	SOT-223 (Pb-Free)	1000 / Tape & Reel
NCV8452STT3G	SOT-223 (Pb-Free)	4000 / Tape & Reel

<sup>†</sup>For information on tape and reel specifications, including part orientation and tape sizes, please refer to our Tape and Reel Packaging Specifications Brochure, BRD8011/D.

**onsemi**, **Onsemi**, and other names, marks, and brands are registered and/or common law trademarks of Semiconductor Components Industries, LLC dba "**onsemi**" or its affiliates and/or subsidiaries in the United States and/or other countries. **onsemi** owns the rights to a number of patents, trademarks, copyrights, trade secrets, and other intellectual property. A listing of **onsemi**'s product/patent coverage may be accessed at [www.onsemi.com/site/pdf/Patent-Marking.pdf](http://www.onsemi.com/site/pdf/Patent-Marking.pdf). **onsemi** reserves the right to make changes at any time to any products or information herein, without notice. The information herein is provided "as-is" and **onsemi** makes no warranty, representation or guarantee regarding the accuracy of the information, product features, availability, functionality, or suitability of its products for any particular purpose, nor does **onsemi** assume any liability arising out of the application or use of any product or circuit, and specifically disclaims any and all liability, including without limitation special, consequential or incidental damages. Buyer is responsible for its products and applications using **onsemi** products, including compliance with all laws, regulations and safety requirements or standards, regardless of any support or applications information provided by **onsemi**. "Typical" parameters which may be provided in **onsemi** data sheets and/or specifications can and do vary in different applications and actual performance may vary over time. All operating parameters, including "Typicals" must be validated for each customer application by customer's technical experts. **onsemi** does not convey any license under any of its intellectual property rights nor the rights of others. **onsemi** products are not designed, intended, or authorized for use as a critical component in life support systems or any FDA Class 3 medical devices or medical devices with a same or similar classification in a foreign jurisdiction or any devices intended for implantation in the human body. Should Buyer purchase or use **onsemi** products for any such unintended or unauthorized application, Buyer shall indemnify and hold **onsemi** and its officers, employees, subsidiaries, affiliates, and distributors harmless against all claims, costs, damages, and expenses, and reasonable attorney fees arising out of, directly or indirectly, any claim of personal injury or death associated with such unintended or unauthorized use, even if such claim alleges that **onsemi** was negligent regarding the design or manufacture of the part. **onsemi** is an Equal Opportunity/Affirmative Action Employer. This literature is subject to all applicable copyright laws and is not for resale in any manner.

## PUBLICATION ORDERING INFORMATION

### LITERATURE FULFILLMENT:

Email Requests to: [orderlit@onsemi.com](mailto:orderlit@onsemi.com)

**onsemi Website:** [www.onsemi.com](http://www.onsemi.com)

### TECHNICAL SUPPORT

**North American Technical Support:**

Voice Mail: 1 800-282-9855 Toll Free USA/Canada

Phone: 011 421 33 790 2910

**Europe, Middle East and Africa Technical Support:**

Phone: 00421 33 790 2910

For additional information, please contact your local Sales Representative