

# 带有单线数字接口的线性 LED 驱动器

## FAN5622, FAN5624, FAN5626

### 说明

FAN5622、FAN5624 和 FAN5626 分别为2-、4-、6-电流阱线性 LED 驱动器，用于移动设备，如手机的液晶显示屏或键盘的背光照明。

压差仅为 50 mV，因而无需电感或开关电容即可驱动LED。LED 输出的亮度等级通过单线数字控制接口来编制。用户可编制32级线性调光等级，并通过施加数字脉冲打开或关闭LED。

FAN562x 系列因其 LED 驱动器的低压差而实现的更高的效率。通过整个32级调光获得LED输出的不同通道之间良好匹配。LED 驱动器还集成了短路检测、欠压以及过热保护功能，从而获得了更为稳定的解决方案。

FAN5622、FAN5624和FAN5626 都采用了非常小巧的封装：分别为 6-pin Super SOT23、10-lead UMLP 以及 10-lead MicroPak™ MLP。

### 产品特性

- 三个线性电流阱 LED 驱动器，可支持2、4或6个LED输出
- 每个 LED 输出的电流阱：
  - ◆ 30 mA 最大输出电流
  - ◆ 50 mV 压差 @ 15 mA
  - ◆ 通道间匹配优于30%
  - ◆ 外接 R<sub>SET</sub>
- 灵活编程的单线数字控制接口
  - ◆ 32级线性调光控制
- 低于 1 μA 关断电流
- 短路、欠压以及热保护
- 宽输入范围：2.7 至 5.5 V
- 小型封装：
  - ◆ FAN5622: 6-Pin Super SOT23
  - ◆ FAN5624: 10-Lead 1.4x1.8x0.55 mm UMLP
  - ◆ FAN5626: 10-Lead 1.6x2.1x0.55 mm MicroPak MLP
- 本产品是为无铅制程



图 1. FAN5622的典型应用



ON Semiconductor®

[www.onsemi.cn](http://www.onsemi.cn)

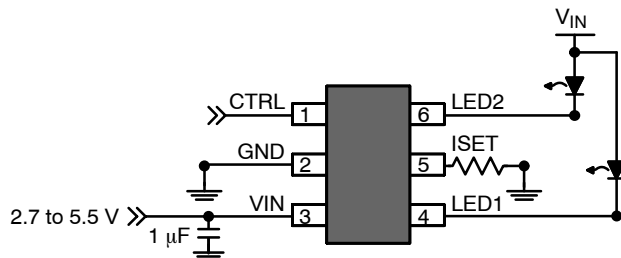
### MARKING DIAGRAM



TSOT23 6-Lead  
CASE 419BL

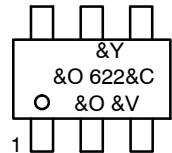

UQFN10 1.4x1.8, 0.4P  
CASE 523BC

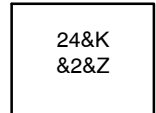

UQFN10 (MICROPAK),  
1.6x2.1, 0.5P  
CASE 523AZ

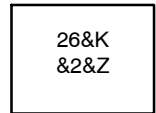

622, 24, 26 = Specific Device Code  
&Y = Binary Calendar Year Coding Scheme  
&O = Plant Code Identifier  
&C = Single Digit Die Run Code  
&V = Eight-Week Binary Datacoding Scheme  
&K = 2-Digits Lot Run Traceability Code  
&2 = 2-Digit Date Code  
&Z = Assembly Plant Code

### ORDERING INFORMATION

See detailed ordering and shipping information on page 9 of this data sheet.

# FAN5622, FAN5624, FAN5626

## 应用框图



图 2. FAN5624 4 LED 的典型应用



图 3. FAN5626 6 LED 的典型应用

## 框图

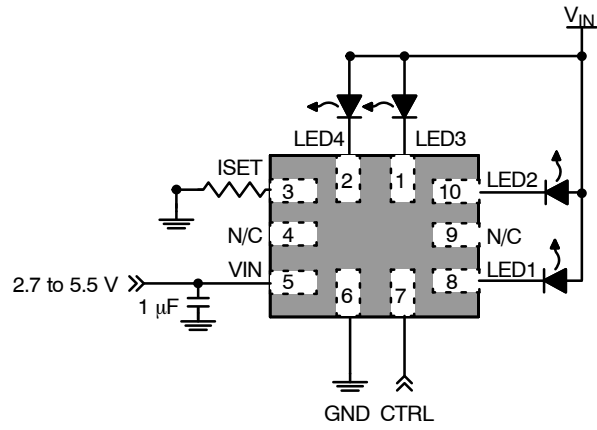

图 4. 框图

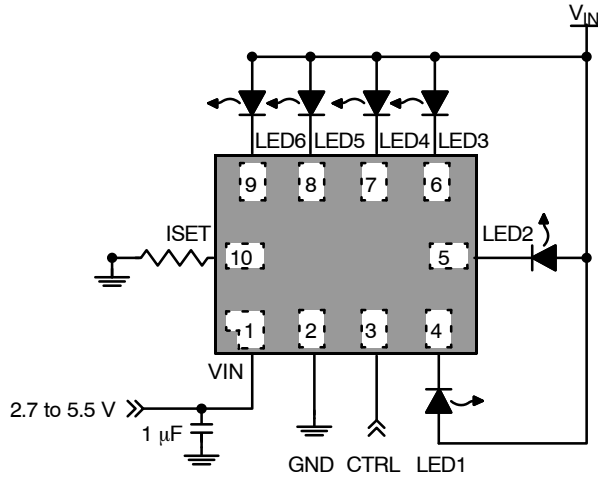
# FAN5622, FAN5624, FAN5626

## 引脚布局

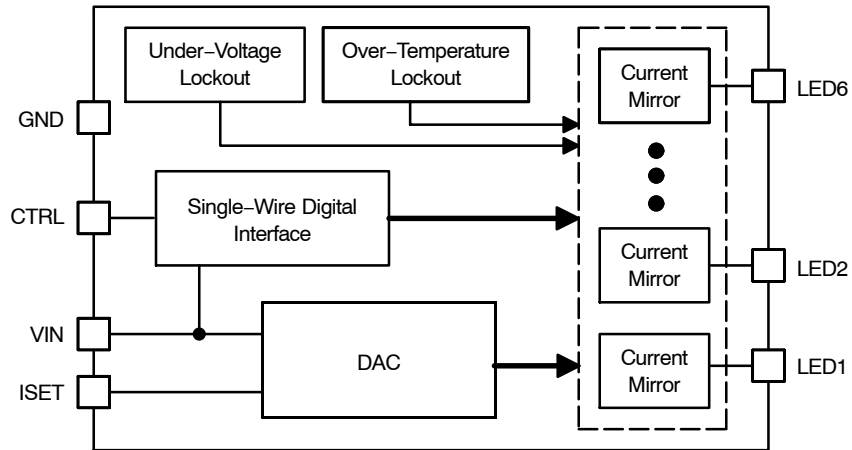

图 5. FAN5622: 6-Pin SSOT23 顶视图



图 6. FAN5624: 10-Lead UMLP 顶视图

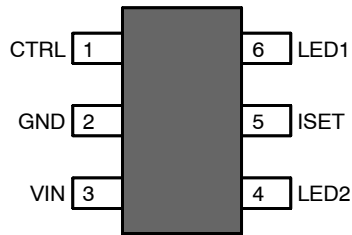

图 7. FAN5626: 10-Lead MicroPak MLP 顶视图

### 引脚说明

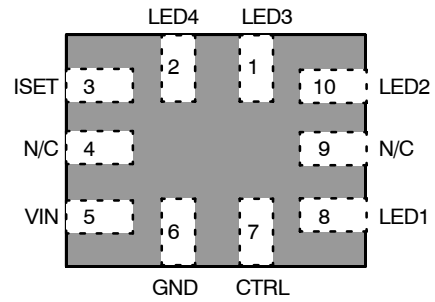
引脚号			名称	说明
FAN5622 SSOT23-6	FAN5624 UMLP10	FAN5626 MicroPak MLP10		
3	5	1	VIN	输入电压。连接至 2.7 – 5.5 VDC 输入电源。
2	6	2	GND	接地
5	3	10	ISET	LED 电流设置。通过将该引脚通过电阻(RSET)接地，可设置满量程 LED 电流。
1	7	3	CTRL	控制引脚。采用数字脉冲驱动该引脚可编制调光等级。 该引脚切勿悬浮。
6	8	4	LED1	LED 阴极 #1。LED 电流阱输出。
4	10	5	LED2	LED 阴极 #2。LED 电流阱输出。
	1	6	LED3	LED 阴极 #3。LED 电流阱输出。
	2	7	LED4	LED 阴极 #4。LED 电流阱输出。
		8	LED5	LED 阴极 #5。LED 电流阱输出。
		9	LED6	LED 阴极 #6。LED 电流阱输出。
	4, 9		N/C	未定义

# FAN5622, FAN5624, FAN5626

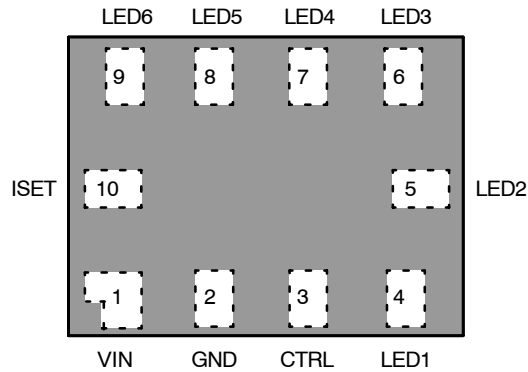
## 绝对最大额定值

符号	参数	最小值	最大值	单位
V <sub>CC</sub>	VIN 引脚	-0.3	6.0	V
	其他引脚 (说明 1)	-0.3	V <sub>IN</sub> + 0.3	V
ESD	静电放电防护等级	人体模型满足JESD22-A114	3.0	kV
		充电器件模型满足JESD22-C101	1.5	kV
T <sub>J</sub>	结温	-40	+150	°C
T <sub>STG</sub>	存储温度	-65	+150	°C
T <sub>L</sub>	引线焊接温度, 10秒	-	+260	°C

Stresses exceeding those listed in the Maximum Ratings table may damage the device. If any of these limits are exceeded, device functionality should not be assumed, damage may occur and reliability may be affected.

(参考译文)

如果电压超过最大额定值表中列出的值范围, 器件可能会损坏。如果超过任何这些限值, 将无法保证器件功能, 可能会导致器件损坏, 影响可靠性。

1. 低于 6.0 V 或 V<sub>IN</sub> + 0.3 V。

## 推荐工作条件

符号	参数	最小值	最大值	单位
V <sub>IN</sub>	电源电压范围	2.7	5.5	V
T <sub>A</sub>	工作环境温度范围	-40	+85	°C
T <sub>J</sub>	工作结点温度范围	-40	+125	°C
I <sub>LED(FS)</sub>	满量程 LED 电流	5	30	mA

Functional operation above the stresses listed in the Recommended Operating Ranges is not implied. Extended exposure to stresses beyond the Recommended Operating Ranges limits may affect device reliability.

(参考译文)

高于推荐工作范围表格中所列电压时, 不保证能够正常运行。长时间在推荐工作范围表格中规定范围以外的电压下运行, 可能会影响器件的可靠性。

**热性能** (结-环境之间热阻与具体应用和电路板布局有关。该数据由符合JESD51-JEDEC标准的测试板测得。特别注意的是, 不要超过给定环境温度T<sub>A</sub>时的结温 T<sub>J(max)</sub>。)

符号	参数	典型值	单位
θ <sub>JA_SSOT23-6</sub>	结-环境之间热阻, SSOT23-6 封装	235	°C/W
θ <sub>JA_UMPL10</sub>	结-环境之间热阻, UMLP10 封装 (说明 2)	287	°C/W
θ <sub>JA_MicroPAK_MLP10</sub>	结-环境之间热阻, MicroPak MLP10 封装 (说明 3)	220	°C/W

2. 建议最大功耗不超过 132 mW。

3. 建议最大功耗不超过 198 mW。

# FAN5622, FAN5624, FAN5626

电气规格 ( $V_{IN} = 2.7\text{ V}$  至  $5.5\text{ V}$ ,  $R_{SET} = 19.10\text{ k}\Omega$ ,  $T_A = -40^\circ\text{C}$  至  $+85^\circ\text{C}$ ,  $V_f = 2.5\text{ V}$  至  $[3.5\text{ V}$  或  $V_{IN} - 0.1\text{ V}]$ , 相对较小。典型值测量条件为  $T_A = 25^\circ\text{C}$ ,  $V_{IN} = 3.6\text{ V}$  且  $V_f = 3.2\text{ V}$ 。)

符号	参数	工作条件	最小值	典型值	最大值	单位
电源						
$I_{SD}$	停机电源电流	$V_{IN} = 3.6\text{ V}$ , $CTRL = 0$	-	0.3	1.0	$\mu\text{A}$
$I_{IN}$	工作电源电流	FAN5622: $V_{IN} = 3.6\text{ V}$ , $I_{LED} = 0\text{ mA}$	-	0.4	0.8	$\text{mA}$
		FAN5624: $V_{IN} = 3.6\text{ V}$ , $I_{LED} = 0\text{ mA}$	-	0.6	1.0	$\text{mA}$
		FAN5626: $V_{IN} = 3.6\text{ V}$ , $I_{LED} = 0\text{ mA}$	-	0.8	1.2	$\text{mA}$
$I_{IH}$	控制引脚输入电流	$CTRL = 1.8\text{ V}$	-	1	250	$\text{nA}$
$V_{UVLO}$	欠压闭锁阈值	$V_{IN}$ 升	-	2.50	2.70	$\text{V}$
		$V_{IN}$ 降	2.10	2.30	2.50	$\text{V}$

## 调节

$I_{FS\_LEDx\ (MAX)}$	满量程 LED 输出电流	$I_{LEDx} = 30\text{ mA}$ ; $x = 1$ 至 $6$	5	-	30	$\text{mA}$
$I_{LED}$	绝对电流精度	$V_{IN} = 2.85\text{ V} - 4.5\text{ V}$ ; $V_{CATH} = 0.15$ 至 $(1.2\text{ V}$ 或 $V_{IN} = 2.55\text{ V}$ , 其相对较小); 满量程电流 $5 - 30\text{ mA}$ , $T_A = 25^\circ\text{C}$	-10	-	+10	%
$I_{LED\ MATCH}$	LED 电流匹配 (说明 4)	$I_{LEDx} = 15\text{ mA}$ ; $V_{LEDx} = 0.4\text{ V}$ , $T_A = 25^\circ\text{C}$	-3	-	+3	%
$V_{ISET}$	$I_{SET}$ 驱动电压	$9.53\text{ k}\Omega \leq R_{SET} \leq 56.2\text{ k}\Omega$	-	1.20	-	$\text{V}$
$I_{RATIO}$	$I_{SET}$ 引脚的电流镜像比	$9.53\text{ k}\Omega \leq R_{SET} \leq 56.2\text{ k}\Omega$	-	240	-	
$\Delta I_{OUT\_LOAD}$	$I_{OUT}$ 负载调节	$V_{IN} = 3.6\text{ V}$ , $I_{LEDx} = 15\text{ mA}$ , $LED\ V_f = 2.7$ to $3.5\text{ V}$	-3	-	+3	%
$\Delta I_{OUT\_LINE}$	$I_{OUT}$ 电源调节	$V_{IN} = 2.7$ 至 $4.8\text{ V}$ , $I_{LEDx} = 15\text{ mA}$ , $V_{CATH} = 0.5\text{ V}$	-4	-	+4	%
$V_{DROPOUT}$	压差	$V_{IN} = 3.6\text{ V}$ ; $I_{LED} = 15\text{ mA}$ , -10% $I_{LED}$ 跌落	-	50	-	$\text{mV}$
		$V_{IN} = 3.6\text{ V}$ ; $I_{LED} = 30\text{ mA}$ , -10% $I_{LED}$ 跌落	-	60	-	
TSD	热关闭	结点温度升高	-	150	-	$^\circ\text{C}$
		滞环	-	20	-	

## 逻辑输入(CTRL)

$V_{IH}$	输入电压高电平		1.2	-	-	$\text{V}$
$V_{IL}$	低电平输入电压		-	-	0.4	$\text{V}$
$T_{LO}$	CTRL LOW 调光时间	$V_{IN} = 3.6\text{ V}$ ; 参见图17	0.5	-	300	$\mu\text{s}$
$T_{HI}$	级间延时	$V_{IN} = 3.6\text{ V}$ ; 参见图17	0.5	-	-	$\mu\text{s}$
$T_{ON}$	CTRL 高电平 至导通延时	$V_{IN} = 3.6\text{ V}$ ; 参见图17	-	250	-	$\mu\text{s}$
$T_{SD}$	CTRL 低电平, 关断脉冲宽度	$V_{IN} = 3.6\text{ V}$ ; 自CTRL的下降沿	1	-	-	$\text{ms}$

Product parametric performance is indicated in the Electrical Characteristics for the listed test conditions, unless otherwise noted. Product performance may not be indicated by the Electrical Characteristics if operated under different conditions.

(参考译文)

除非另有说明,“电气特性”表格中列出的是所列测试条件下的产品性能参数。如果在不同条件下运行,产品性能可能与“电气特性”表格中所列性能参数不一致。

4. 分别为FAN5622、FAN5624以及FAN5626的2、4、6 LED 电流阱;以下对应于:2、4、6 LED 输出的最大电流阱(MAX);2、4、6 LED 输出的最小电流阱(MIN);以及平均电流阱(AVG)。对于所有的LED输出,计算两个匹配数值:(MAX - AVG) / AVG 和 (AVG - MIN) / AVG。选择给定部分的匹配值作为两个中的最高匹配值。既定部分的匹配值应为所有LED输出中匹配度最高的。提供的典型规格就是所有部分的最大可能匹配基准。

典型性能特征



图 8. 效率 vs. 输入电压 LED  $V_F = 3.2 V$



图 9. 压差 vs. 输入电压

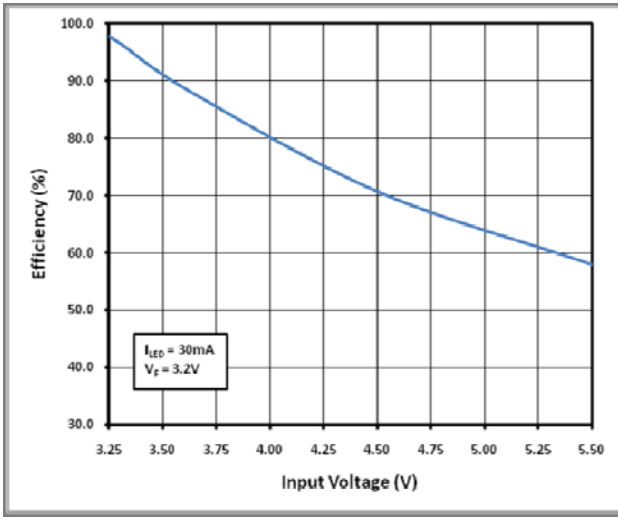

图 10. 通道的电流匹配 vs. 输入电压

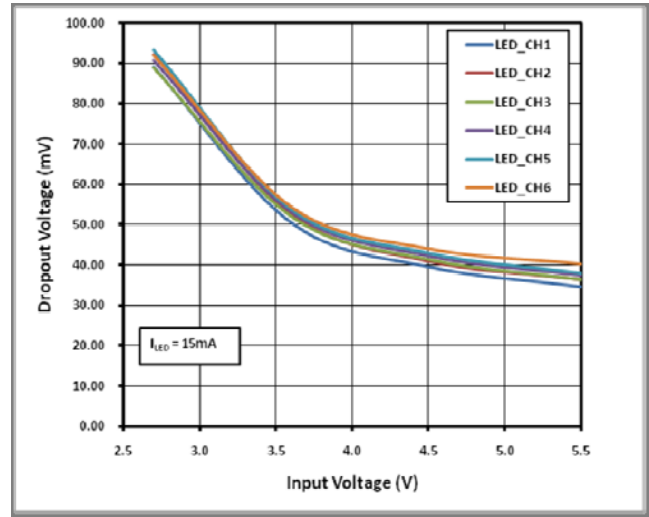

图 11. 15 mA 的负载调节/输出

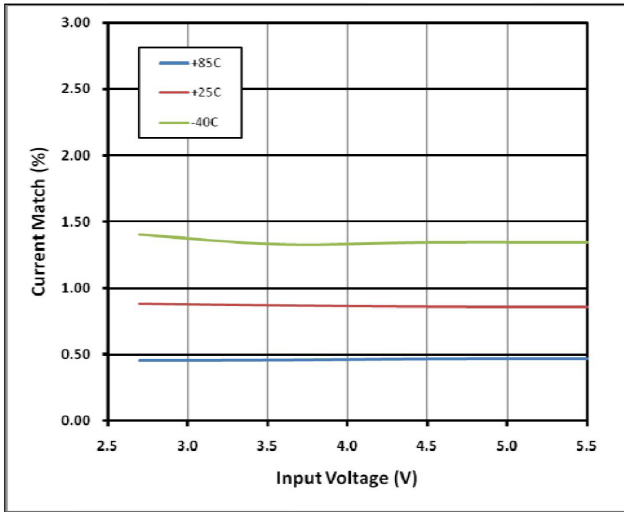

图 12. 停机电流 vs. 输入电压

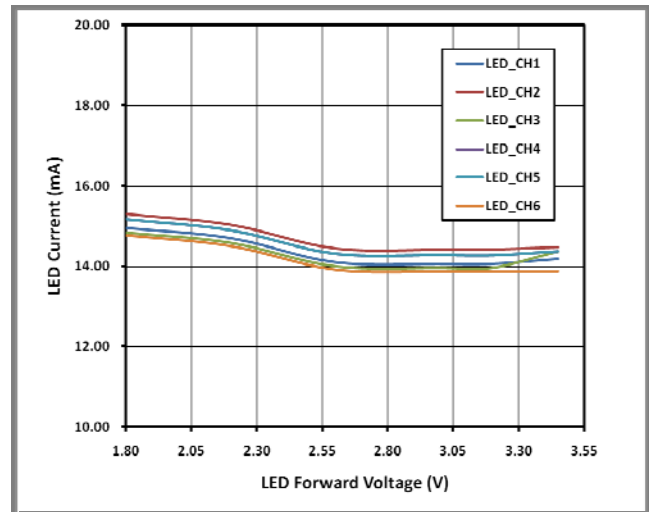

图 13. 静态电流 vs. 输入电压

典型性能特征

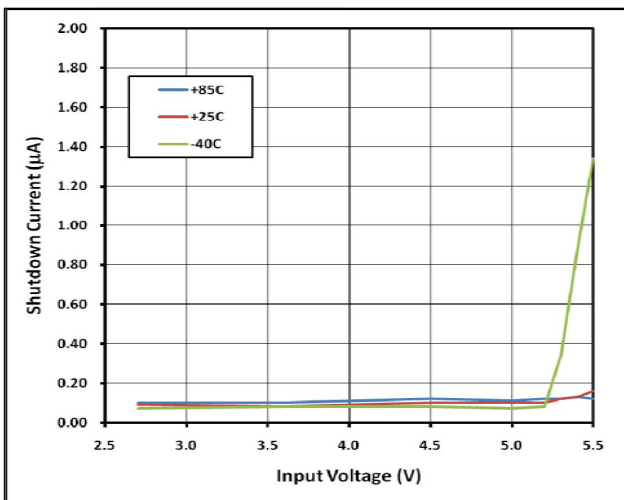

图 14. FAN5626 的启动波形

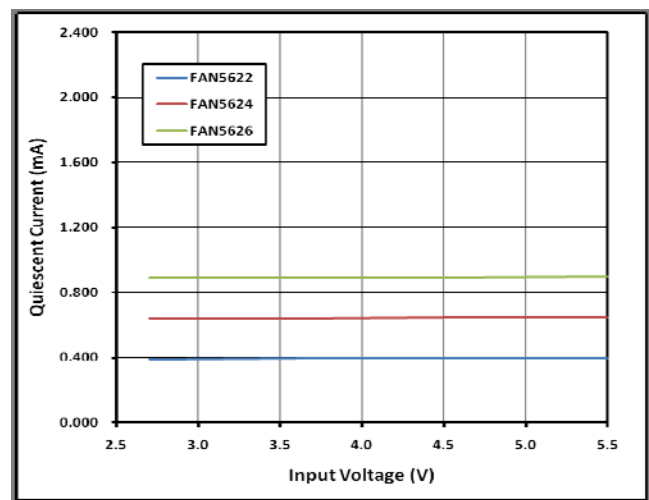

图 15. FAN5626 的关断波形

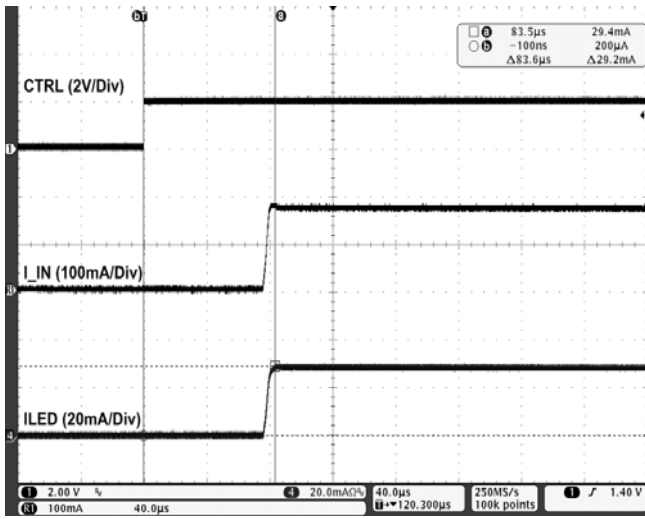

图 16. 调光操作

## 电路说明

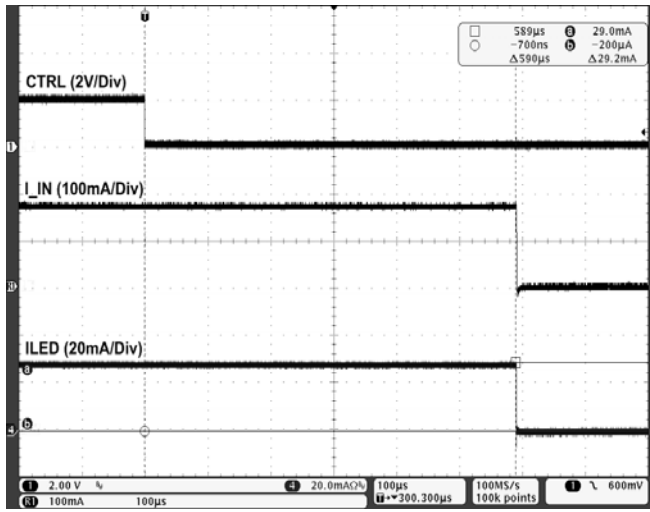
FAN5622、FAN5624 和 FAN5626 系列为电流阱线性 LED 驱动器，该系列芯片分别可驱动 2、4 或 6 个 LED。这三款器件使用 2.7 V 至 5.5 V 电源直接供电，所有的通道通过外部电源集成的电流阱来控制。设计采用了极低的压差，FAN562x 系列产品以接近输入电压的水平工作，无需额外的电感升压或电容开关电路。

这三款器件只需要两个额外的分立无源部件：一个 1  $\mu$ F 陶瓷输入电容和电阻( $R_{SET}$ )，用来设置 LED 的最大电流。每个电流阱输出可提供恒定电流，并以最高可达 30 mA 的电流驱动 LED。安森美半导体的 TinyWire 单线数控接口，可让 LED 驱动器对 LED 的亮度进行 32 级线性调整。

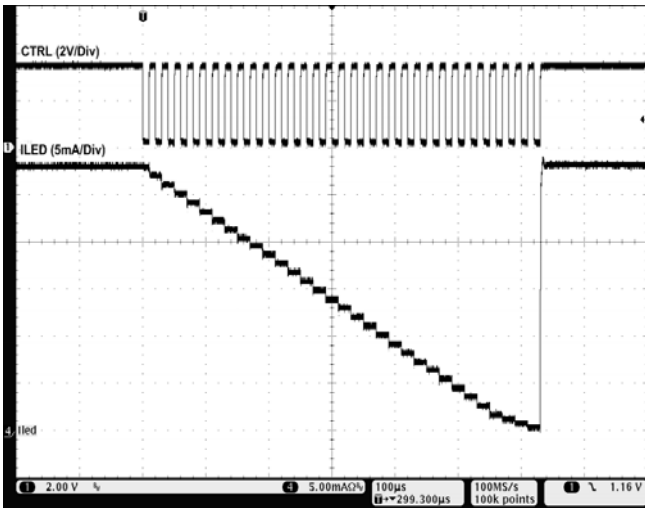
## 设置最大电流

FAN5622、FAN5624 以及 FAN5626 的最大 LED 电流使用叫做 RSET 的外接电阻来编制。三款 LED 驱动器的最大满量程 LED 电流为 30 mA，最低可达 5 mA。FAN562x 系列产品也可在低于 5 mA 满量程 LED 电流下工作，但需使用一个较大的  $R_{SET}$ 。但是，仍可确保 LED 通道的精度和匹配规格。表 1 显示多个满量程电流级别适用的 RSET 电阻值。

表 1. 使用电阻设置最大 LED 电流

$I_{LED}$ (mA)	$R_{SET}$ (k $\Omega$ )
5	56.20
10	28.70
15	19.10
20	14.30
25	11.50
30	9.53

## 数字接口和调光控制

FAN5622、FAN5624 和 FAN5626 采用简单的单线数控接口，可通过数字脉冲对 LED 的亮度进行 32 级线性调整。为了保持一定调光等级下 LED 的亮度，施加在 CTRL 引脚上的数字脉冲信号的最后一个脉冲必须保持高电平。根据所需时间保持为高电平，在此期间 LED 照明为指定亮度等级。表 2 显示了调光等级，而图 17 显示如何改变调光等级。

表 2. 亮度控制等级 ( $R_{SET} = 19.10$  k $\Omega$ )

调光等级	电流值	$I_{LED}$ (mA)
1	1.67%	0.25
2	3.33%	0.50
3	5.00%	0.75
4	6.67%	1.00
5	10.00%	1.50
6	13.33%	2.00
7	16.67%	2.50
8	20.00%	3.00
9	23.33%	3.50
10	26.67%	4.00
11	30.00%	4.50
12	33.33%	5.00
13	36.67%	5.50
14	40.00%	6.00
15	43.33%	6.50
16	46.67%	7.00
17	50.00%	7.50
18	53.33%	8.00
19	56.67%	8.50
20	60.00%	9.00
21	63.33%	9.50
22	66.67%	10.00
23	70.00%	10.50
24	73.33%	11.00
25	76.67%	11.50
26	80.00%	12.00
27	83.33%	12.50
28	86.67%	13.00
29	90.00%	13.50
30	93.33%	14.00
31	96.67%	14.50
32	100.00%	15.00



# FAN5622, FAN5624, FAN5626

## 数字调光控制



图 17. 数字脉冲调光控制图

## 订购信息

器件型号	通道号	温度范围	封装	包装 <sup>†</sup>
FAN5622SX	2	-40 to 85°C	6-Lead, SSOT23 (Pb-Free)	3000 / 卷带
FAN5624UMPX	4	-40 to 85°C	10-Lead UMLP (Pb-Free)	5000 / 卷带
FAN5626LX	6	-40 to 85°C	10-Lead MicroPak MLP (Pb-Free)	5000 / 卷带

<sup>†</sup>For information on tape and reel specifications, including part orientation and tape sizes, please refer to our Tape and Reel Packaging Specifications Brochure, BRD8011/D.

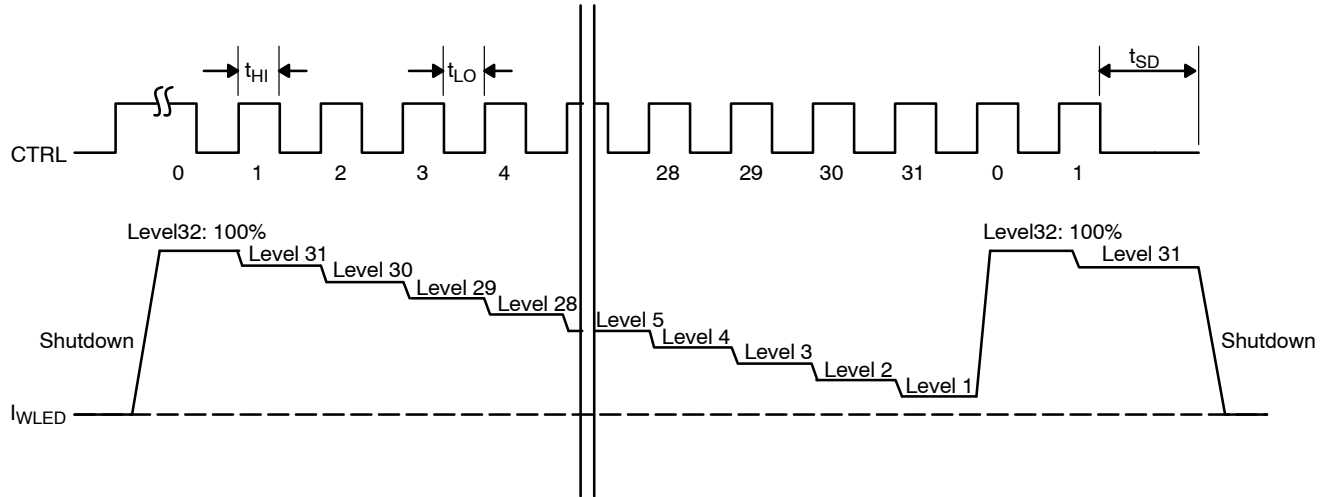
# MECHANICAL CASE OUTLINE

## PACKAGE DIMENSIONS

ON Semiconductor®



1  
SCALE 2:1

### TSOT23 6-Lead CASE 419BL ISSUE A

DATE 31 AUG 2020

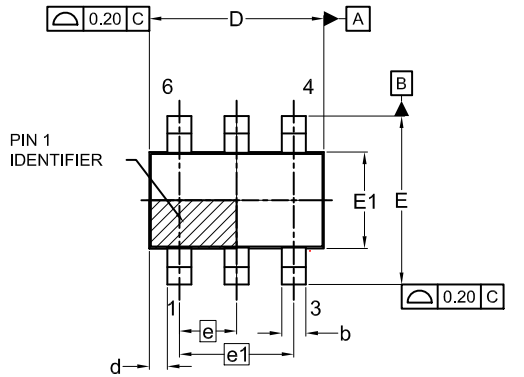

TOP VIEW

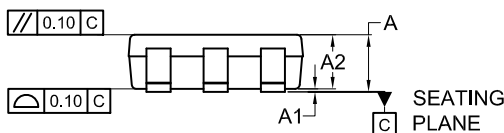

FRONT VIEW

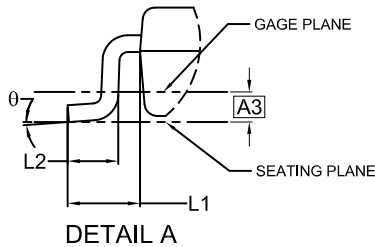

DETAIL A

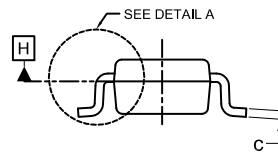

SIDE VIEW

SYMM  
⌀

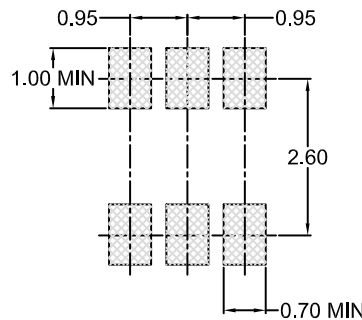

LAND PATTERN  
RECOMMENDATION

\*FOR ADDITIONAL INFORMATION ON OUR  
Pb-FREE STRATEGY AND SOLDERING DETAILS,  
PLEASE DOWNLOAD THE ON SEMICONDUCTOR  
SOLDERING AND MOUNTING TECHNIQUES  
REFERENCE MANUAL, SOLDERRM/D.

NOTES:

1. DIMENSIONING AND TOLERANCING PER ASME Y14.5M, 2009.
2. CONTROLLING DIMENSION: MILLIMETERS
3. DIMENSIONS D AND E1 DO NOT INCLUDE MOLD FLASH, PROTRUSIONS, OR GATE BURRS. MOLD FLASH, PROTRUSIONS OR GATE BURRS SHALL NOT EXCEED 0.25MM PER END. DIMENSIONS D AND E1 ARE DETERMINED AT DATUM H.
4. SEATING PLANE IS DEFINED BY THE TERMINALS. "A1" IS DEFINED AS THE DISTANCE FROM THE SEATING PLANE TO THE LOWEST POINT ON THE PACKAGE BODY.

DIM	MILLIMETERS		
	MIN.	NOM.	MAX.
A	0.90	1.00	1.10
A1	0.00	0.05	0.10
A2	0.70	0.85	1.00
A3	0.25 BSC		
b	0.25	0.38	0.50
c	0.10	0.18	0.26
D	2.80	2.95	3.10
d	0.30 REF		
E	2.50	2.75	3.00
E1	1.30	1.50	1.70
e	0.95 BSC		
e1	1.90 BSC		
L1	0.60 REF		
L2	0.20	0.40	0.60
⌀	0°	--	10°

#### GENERIC MARKING DIAGRAM\*

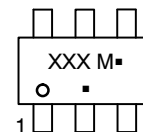

XXX = Specific Device Code  
M = Date Code  
▪ = Pb-Free Package

(Note: Microdot may be in either location)

\*This information is generic. Please refer to device data sheet for actual part marking. Pb-Free indicator, "G" or microdot "▪", may or may not be present. Some products may not follow the Generic Marking.

DOCUMENT NUMBER:	98AON83292G	Electronic versions are uncontrolled except when accessed directly from the Document Repository. Printed versions are uncontrolled except when stamped "CONTROLLED COPY" in red.
DESCRIPTION:	TSOT23 6-Lead	PAGE 1 OF 1

ON Semiconductor and ON are trademarks of Semiconductor Components Industries, LLC dba ON Semiconductor or its subsidiaries in the United States and/or other countries. ON Semiconductor reserves the right to make changes without further notice to any products herein. ON Semiconductor makes no warranty, representation or guarantee regarding the suitability of its products for any particular purpose, nor does ON Semiconductor assume any liability arising out of the application or use of any product or circuit, and specifically disclaims any and all liability, including without limitation special, consequential or incidental damages. ON Semiconductor does not convey any license under its patent rights nor the rights of others.

# MECHANICAL CASE OUTLINE

## PACKAGE DIMENSIONS

ON Semiconductor®



### UQFN10 (MICROPAK™), 1.6X2.1, 0.5P CASE 523AZ ISSUE A

DATE 11 DEC 2019

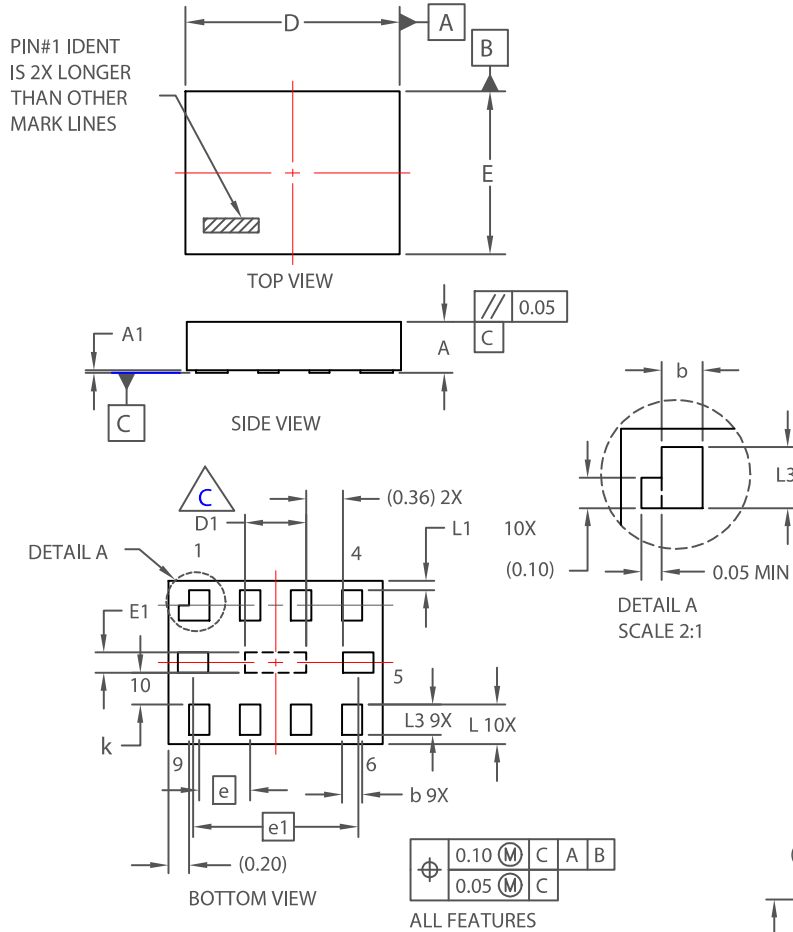

NOTES:

- A. PACKAGE CONFORMS TO JEDEC REGISTRATION MO-255, VARIATION UABD.
- B. DIMENSIONS ARE IN MILLIMETERS.
- C. PRESENCE OF CENTER PAD IS PACKAGE SUPPLIER DEPENDENT. IF PRESENT IT IS NOT INTENDED TO BE SOLDERED AND HAS A BLACK OXIDE FINISH.
- D. DIMENSIONS WITHIN ( ) ARE UNCONTROLLED.

DIM	MIN.	NOM.	MAX.
A	0.50	0.55	0.65
A1	0.00	0.025	0.05
b	0.15	0.20	0.25
D	2.00	2.10	2.20
D1	0.55	0.60	0.65
E	1.50	1.60	1.70
E1	0.15	0.20	0.25
e	0.50 BSC		
e1	1.62 BSC		
k	0.20	--	--
L	0.25	0.30	0.42
L1	0.00	0.09	0.15
L3	0.25	0.30	0.35

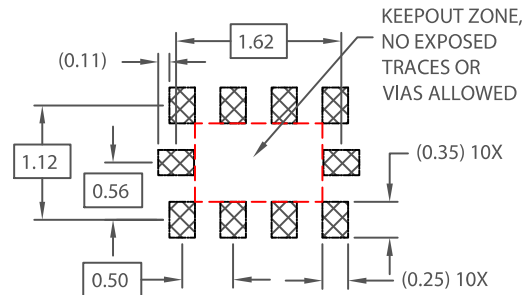

RECOMMENDED MOUNTING FOOTPRINT\*

\*FOR ADDITIONAL INFORMATION ON OUR Pb-FREE STRATEGY AND SOLDERING DETAILS, PLEASE DOWNLOAD THE ON SEMICONDUCTOR SOLDERING AND MOUNTING TECHNIQUES REFERENCE MANUAL, SOLDERRM/D.

<b>DOCUMENT NUMBER:</b>	<b>98AON13592G</b>	Electronic versions are uncontrolled except when accessed directly from the Document Repository. Printed versions are uncontrolled except when stamped "CONTROLLED COPY" in red.
<b>DESCRIPTION:</b>	<b>UQFN10 (MICROPAK™), 1.6X2.1, 0.5P</b>	<b>PAGE 1 OF 1</b>

ON Semiconductor and ON are trademarks of Semiconductor Components Industries, LLC dba ON Semiconductor or its subsidiaries in the United States and/or other countries. ON Semiconductor reserves the right to make changes without further notice to any products herein. ON Semiconductor makes no warranty, representation or guarantee regarding the suitability of its products for any particular purpose, nor does ON Semiconductor assume any liability arising out of the application or use of any product or circuit, and specifically disclaims any and all liability, including without limitation special, consequential or incidental damages. ON Semiconductor does not convey any license under its patent rights nor the rights of others.

# MECHANICAL CASE OUTLINE

## PACKAGE DIMENSIONS

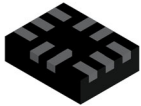

**UQFN10 1.4x1.8, 0.4P**  
CASE 523BC  
ISSUE B

DATE 13 MAY 2022

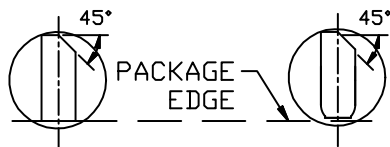
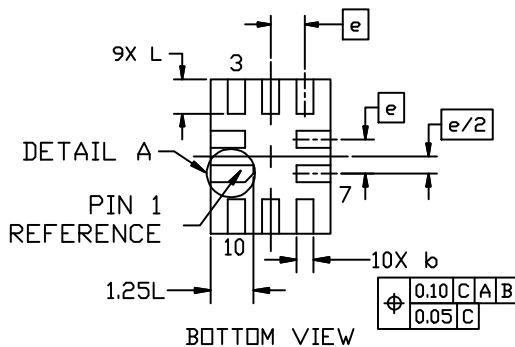
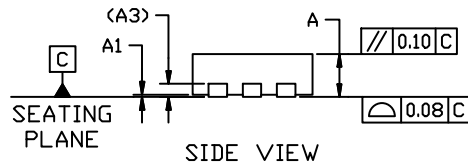
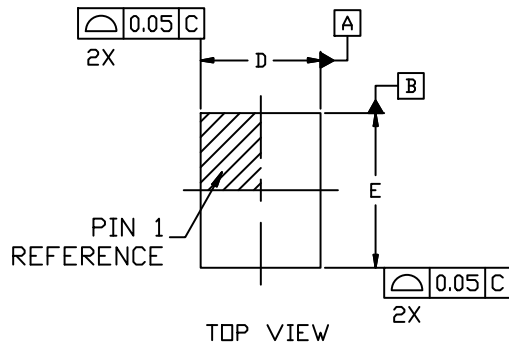

OPTIONAL CONSTRUCTIONS

NOTES:

1. DIMENSIONING AND TOLERANCING PER ASME Y14.5, 2018
2. ALL DIMENSIONS ARE IN MILLIMETERS
3. DIMENSION *b* APPLIES TO PLATED TERMINALS AND IS MEASURED BETWEEN 0.15mm AND 0.30mm FROM THE TERMINAL TIP.
4. COPLANARITY APPLIES TO THE EXPOSED PAD AS WELL AS THE TERMINALS

DIM	MILLIMETERS		
	MIN.	NOM.	MAX.
A	0.45	0.50	0.55
A1	0.00	0.025	0.05
A3	0.152 REF		
<i>b</i>	0.15	0.20	0.25
D	1.35	1.40	1.45
E	1.75	1.80	1.85
<i>e</i>	0.40 BSC		
L	0.35	0.40	0.45

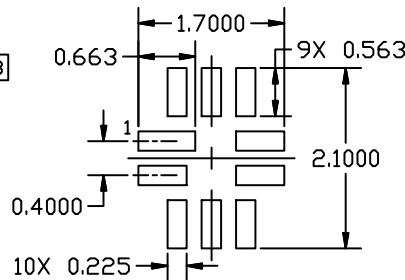

RECOMMENDED LAND PATTERN

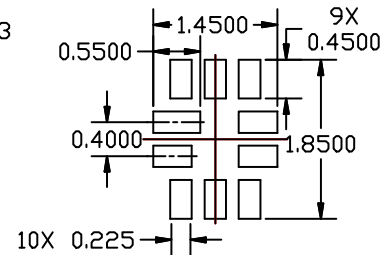

OPTIONAL MINIMAL TOE LAND PATTERN

RECOMMENDED MOUNTING FOOTPRINT

For additional information on our Pb-Free strategy and soldering details, please download the onsemi Soldering and Mounting Techniques Reference Manual, SOLDERRM/D.

<b>DOCUMENT NUMBER:</b>	<b>98AON13705G</b>	Electronic versions are uncontrolled except when accessed directly from the Document Repository. Printed versions are uncontrolled except when stamped "CONTROLLED COPY" in red.
<b>DESCRIPTION:</b>	<b>UQFN10 1.4x1.8, 0.4P</b>	<b>PAGE 1 OF 1</b>

onsemi and ONSEMI are trademarks of Semiconductor Components Industries, LLC dba onsemi or its subsidiaries in the United States and/or other countries. onsemi reserves the right to make changes without further notice to any products herein. onsemi makes no warranty, representation or guarantee regarding the suitability of its products for any particular purpose, nor does onsemi assume any liability arising out of the application or use of any product or circuit, and specifically disclaims any and all liability, including without limitation special, consequential or incidental damages. onsemi does not convey any license under its patent rights nor the rights of others.

**onsemi**, **Onsemi**, and other names, marks, and brands are registered and/or common law trademarks of Semiconductor Components Industries, LLC dba "**onsemi**" or its affiliates and/or subsidiaries in the United States and/or other countries. **onsemi** owns the rights to a number of patents, trademarks, copyrights, trade secrets, and other intellectual property. A listing of **onsemi**'s product/patent coverage may be accessed at [www.onsemi.com/site/pdf/Patent-Marking.pdf](http://www.onsemi.com/site/pdf/Patent-Marking.pdf). **onsemi** reserves the right to make changes at any time to any products or information herein, without notice. The information herein is provided "as-is" and **onsemi** makes no warranty, representation or guarantee regarding the accuracy of the information, product features, availability, functionality, or suitability of its products for any particular purpose, nor does **onsemi** assume any liability arising out of the application or use of any product or circuit, and specifically disclaims any and all liability, including without limitation special, consequential or incidental damages. Buyer is responsible for its products and applications using **onsemi** products, including compliance with all laws, regulations and safety requirements or standards, regardless of any support or applications information provided by **onsemi**. "Typical" parameters which may be provided in **onsemi** data sheets and/or specifications can and do vary in different applications and actual performance may vary over time. All operating parameters, including "Typicals" must be validated for each customer application by customer's technical experts. **onsemi** does not convey any license under any of its intellectual property rights nor the rights of others. **onsemi** products are not designed, intended, or authorized for use as a critical component in life support systems or any FDA Class 3 medical devices or medical devices with a same or similar classification in a foreign jurisdiction or any devices intended for implantation in the human body. Should Buyer purchase or use **onsemi** products for any such unintended or unauthorized application, Buyer shall indemnify and hold **onsemi** and its officers, employees, subsidiaries, affiliates, and distributors harmless against all claims, costs, damages, and expenses, and reasonable attorney fees arising out of, directly or indirectly, any claim of personal injury or death associated with such unintended or unauthorized use, even if such claim alleges that **onsemi** was negligent regarding the design or manufacture of the part. **onsemi** is an Equal Opportunity/Affirmative Action Employer. This literature is subject to all applicable copyright laws and is not for resale in any manner.

## PUBLICATION ORDERING INFORMATION

### LITERATURE FULFILLMENT:

Email Requests to: [orderlit@onsemi.com](mailto:orderlit@onsemi.com)

**onsemi Website:** [www.onsemi.com](http://www.onsemi.com)

### TECHNICAL SUPPORT

**North American Technical Support:**

Voice Mail: 1 800-282-9855 Toll Free USA/Canada

Phone: 011 421 33 790 2910

**Europe, Middle East and Africa Technical Support:**

Phone: 00421 33 790 2910

For additional information, please contact your local Sales Representative