

# ESD7383

## ESD Protection

### 3-Line, Very Low Capacitance

#### Product Description

The ESD7383 is a 4-bump very low capacitance ESD protection device in 0.4 mm CSP form factor. It is fully compliant with IEC 61000-4-2. The ESD7383 is RoHS II compliant.

#### Features

- These Devices are Pb-Free and are RoHS Compliant

#### Applications

- ESD protection for USB (including USB OTG)
  - ◆ USB compliance
  - High Speed USB port
  - Up to 480 Mb/s according to USB 2.0 high speed specification



**ON Semiconductor®**

[www.onsemi.com](http://www.onsemi.com)

#### ELECTRICAL SCHEMATIC

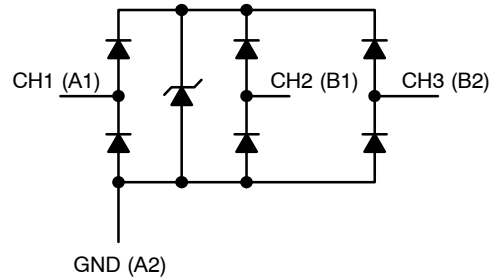

GND (A2)



WLCSP4  
CASE 567CB

#### MARKING DIAGRAM



7 = Specific Device Code  
M = Date Code

#### PINOUT

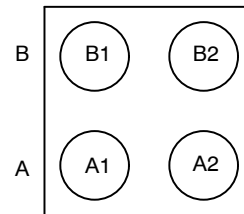

1 2  
BOTTOM VIEW

#### MAXIMUM RATINGS ( $T_A = 25^\circ\text{C}$ unless otherwise noted)

Rating	Symbol	Value	Unit
Peak Pulse Power Dissipation, 8 x 20 $\mu\text{s}$	$P_{pk}$	50	W
Maximum Peak Pulse Current, 8 x 20 $\mu\text{s}$	$I_{pp}$	2.5	A
Operating Junction Temperature Range	$T_J$	-40 to +85	$^\circ\text{C}$
Storage Temperature Range	$T_{stg}$	-55 to +150	$^\circ\text{C}$
IEC 61000-4-2 Contact (ESD)	ESD	$\pm 8000$	V

Stresses exceeding those listed in the Maximum Ratings table may damage the device. If any of these limits are exceeded, device functionality should not be assumed, damage may occur and reliability may be affected.

#### PIN DESCRIPTIONS

Pin	Description
A1	ESD Channel 1
A2	Device Ground
B1	ESD Channel 2
B2	ESD Channel 3

#### ORDERING INFORMATION

See detailed ordering and shipping information in the package dimensions section on page 2 of this data sheet.

# ESD7383

## ELECTRICAL SPECIFICATIONS AND CONDITIONS

### ELECTRICAL OPERATING CHARACTERISTICS (Note 1)

Symbol	Parameter	Conditions	Min	Typ	Max	Unit
$V_{IN}$	Input Operating Supply Voltage			3.0	5.5	V
$V_{BR}$	Breakdown Voltage	$I_T = 8 \text{ mA}$	6			V
$I_R$	Reverse Leakage Current	$V_{RM} = 3 \text{ V}$			100	nA
$C_{IN}$	Channel Input Capacitance	At 1 MHz, $V_{IN} = 0 \text{ V}$			1.5	pF
$\Delta C_{IN}$	Channel Input Capacitance Matching	At 1 MHz, $V_{IN} = 0 \text{ V}$		0.02		pF
$V_{CL}$	Channel Clamp Voltage Positive Transients Negative Transients	$I_{PP} = 1 \text{ A}$ , $t_P = 8/20 \text{ }\mu\text{s}$		+10 -1.5		V
$R_{DYN}$	Dynamic Resistance Positive Transients Negative Transients	$I_{PP} = 1 \text{ A}$ , $t_P = 8/20 \text{ }\mu\text{s}$ Any I/O pin to Ground		0.6 0.5		$\Omega$ $\Omega$

1. All parameters specified at  $T_A = 25^\circ\text{C}$  unless otherwise noted.

### ORDERING INFORMATION

Part Number	Bumps	Variation	Part Marking	Package	Shipping <sup>†</sup>
ESD7383	4	WLCSP4	7	CSP (Pb-Free)	5000 / Tape & Reel

<sup>†</sup>For information on tape and reel specifications, including part orientation and tape sizes, please refer to our Tape and Reel Packaging Specifications Brochure, BRD8011/D.

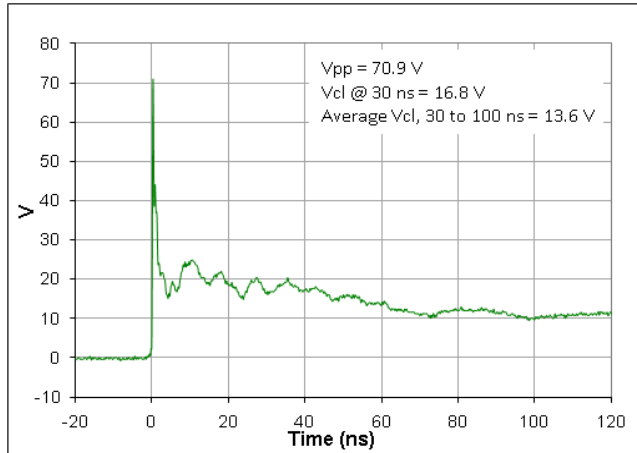

**Figure 1. ESD Clamping Voltage Screenshot  
Positive 8 kV Contact per IEC61000-4-2**

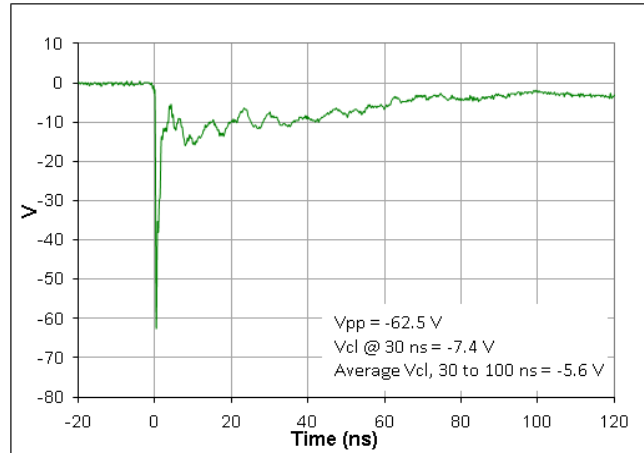

**Figure 2. ESD Clamping Voltage Screenshot  
Negative 8 kV Contact per IEC61000-4-2**

IEC61000-4-2 Spec.

Level	Test Voltage (kV)	First Peak Current (A)	Current at 30 ns (A)	Current at 60 ns (A)
1	2	7.5	4	2
2	4	15	8	4
3	6	22.5	12	6
4	8	30	16	8



Figure 3. IEC61000-4-2 Spec

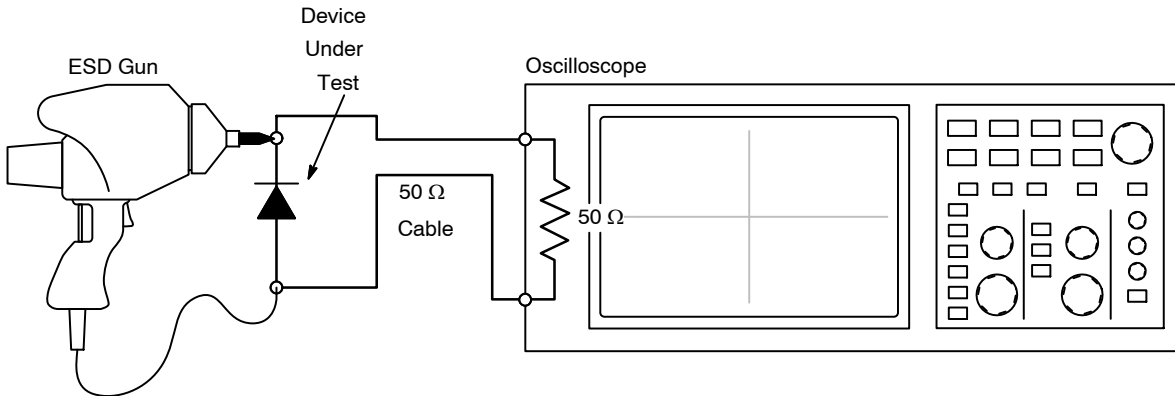

Figure 4. Diagram of ESD Clamping Voltage Test Setup

The following is taken from Application Note AND8308/D – Interpretation of Datasheet Parameters for ESD Devices.

ESD Voltage Clamping

For sensitive circuit elements it is important to limit the voltage that an IC will be exposed to during an ESD event to as low a voltage as possible. The ESD clamping voltage is the voltage drop across the ESD protection diode during an ESD event per the IEC61000-4-2 waveform. Since the IEC61000-4-2 was written as a pass/fail spec for larger

systems such as cell phones or laptop computers it is not clearly defined in the spec how to specify a clamping voltage at the device level. ON Semiconductor has developed a way to examine the entire voltage waveform across the ESD protection diode over the time domain of an ESD pulse in the form of an oscilloscope screenshot, which can be found on the datasheets for all ESD protection diodes. For more information on how ON Semiconductor creates these screenshots and how to interpret them please refer to AND8307/D.

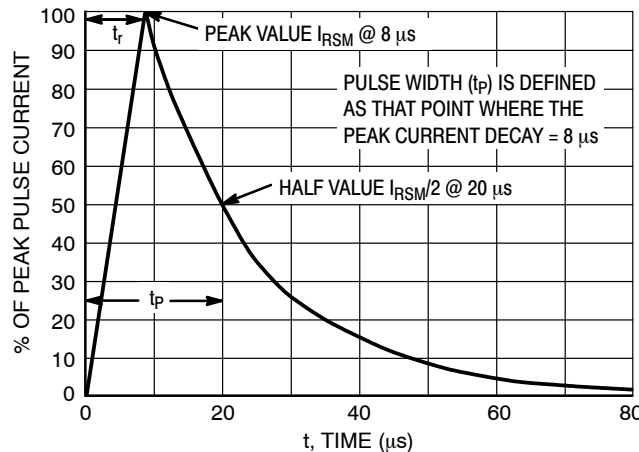

Figure 5. 8 x 20 μs Pulse Waveform

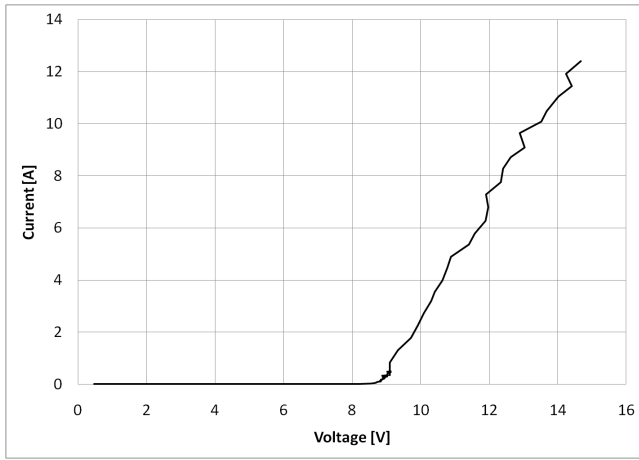

Figure 6. Positive TLP I-V Curve

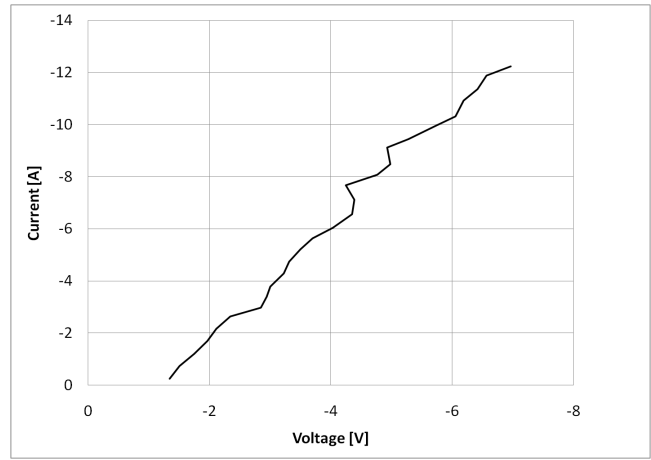

Figure 7. Negative TLP I-V Curve

**Transmission Line Pulse (TLP) Measurement**

Transmission Line Pulse (TLP) provides current versus voltage (I-V) curves in which each data point is obtained from a 100 ns long rectangular pulse from a charged transmission line. A simplified schematic of a typical TLP system is shown in Figure 8. TLP I-V curves of ESD protection devices accurately demonstrate the product’s ESD capability because the 10s of amps current levels and under 100 ns time scale match those of an ESD event. This is illustrated in Figure 9 where an 8 kV IEC61000-4-2 current waveform is compared with TLP current pulses at 8 A and 16 A. A TLP I-V curve shows the voltage at which the device turns on as well as how well the device clamps voltage over a range of current levels. A typical TLP I-V curve for the ESD7383 is shown in Figures 6 and 7.

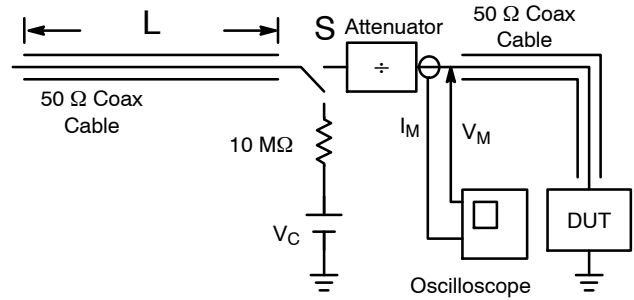

Figure 8. Simplified Schematic of a Typical TLP System

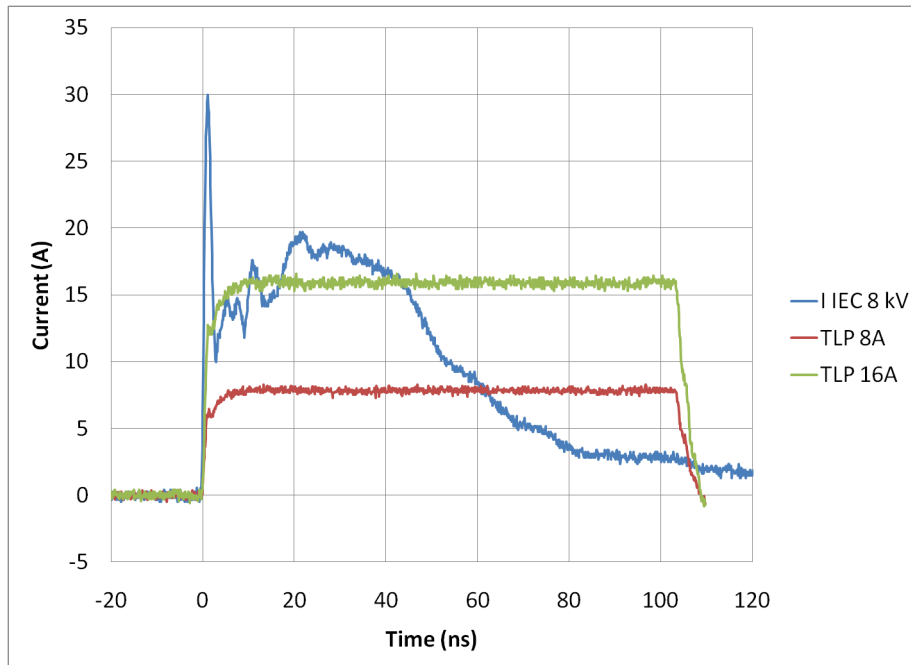
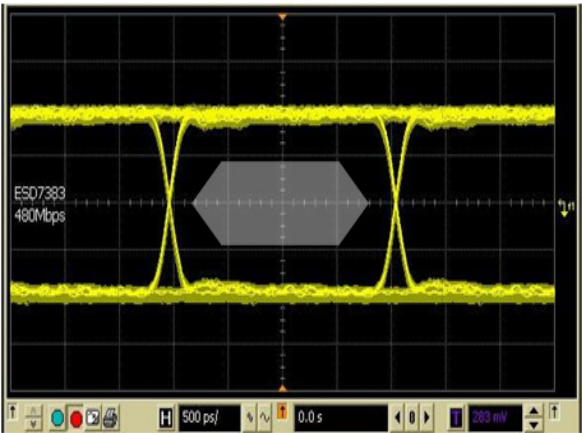

Figure 9. Comparison Between 8 kV IEC61000-4-2 and 8 A and 16 A TLP Waveforms



**Figure 10. 480 Mb/s USB Source  
Clears USB 2.0 Hi Speed Mask**

# MECHANICAL CASE OUTLINE PACKAGE DIMENSIONS

ON Semiconductor®



SCALE 4:1

WLCSP4, 0.8x0.8  
CASE 567CB-01  
ISSUE 0

DATE 26 JUL 2010

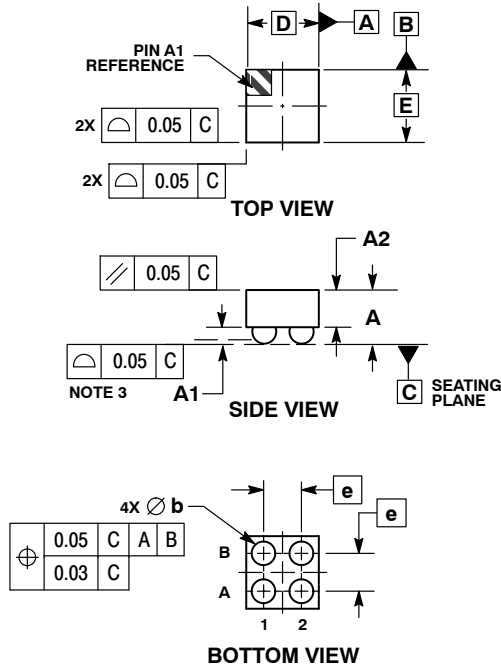

NOTES:

1. DIMENSIONING AND TOLERANCING PER ASME Y14.5M, 1994.
2. CONTROLLING DIMENSION: MILLIMETERS.
3. COPLANARITY APPLIES TO SPHERICAL CROWNS OF SOLDER BALLS.

DIM	MILLIMETERS	
	MIN	MAX
A	0.57	0.63
A1	0.17	0.24
A2	0.41	REF
b	0.24	0.29
D	0.80	BSC
E	0.80	BSC
e	0.40	BSC

**RECOMMENDED  
SOLDERING FOOTPRINT\***

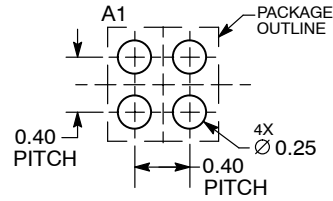

DIMENSIONS: MILLIMETERS

\*For additional information on our Pb-Free strategy and soldering details, please download the ON Semiconductor Soldering and Mounting Techniques Reference Manual, SOLDERRM/D.

<b>DOCUMENT NUMBER:</b>	<b>98AON50305E</b>	Electronic versions are uncontrolled except when accessed directly from the Document Repository. Printed versions are uncontrolled except when stamped "CONTROLLED COPY" in red.
<b>DESCRIPTION:</b>	<b>WLCSP4, 0.8X0.8</b>	<b>PAGE 1 OF 1</b>

ON Semiconductor and are trademarks of Semiconductor Components Industries, LLC dba ON Semiconductor or its subsidiaries in the United States and/or other countries. ON Semiconductor reserves the right to make changes without further notice to any products herein. ON Semiconductor makes no warranty, representation or guarantee regarding the suitability of its products for any particular purpose, nor does ON Semiconductor assume any liability arising out of the application or use of any product or circuit, and specifically disclaims any and all liability, including without limitation special, consequential or incidental damages. ON Semiconductor does not convey any license under its patent rights nor the rights of others.

**onsemi**, **Onsemi**, and other names, marks, and brands are registered and/or common law trademarks of Semiconductor Components Industries, LLC dba "**onsemi**" or its affiliates and/or subsidiaries in the United States and/or other countries. **onsemi** owns the rights to a number of patents, trademarks, copyrights, trade secrets, and other intellectual property. A listing of **onsemi**'s product/patent coverage may be accessed at [www.onsemi.com/site/pdf/Patent-Marking.pdf](http://www.onsemi.com/site/pdf/Patent-Marking.pdf). **onsemi** reserves the right to make changes at any time to any products or information herein, without notice. The information herein is provided "as-is" and **onsemi** makes no warranty, representation or guarantee regarding the accuracy of the information, product features, availability, functionality, or suitability of its products for any particular purpose, nor does **onsemi** assume any liability arising out of the application or use of any product or circuit, and specifically disclaims any and all liability, including without limitation special, consequential or incidental damages. Buyer is responsible for its products and applications using **onsemi** products, including compliance with all laws, regulations and safety requirements or standards, regardless of any support or applications information provided by **onsemi**. "Typical" parameters which may be provided in **onsemi** data sheets and/or specifications can and do vary in different applications and actual performance may vary over time. All operating parameters, including "Typicals" must be validated for each customer application by customer's technical experts. **onsemi** does not convey any license under any of its intellectual property rights nor the rights of others. **onsemi** products are not designed, intended, or authorized for use as a critical component in life support systems or any FDA Class 3 medical devices or medical devices with a same or similar classification in a foreign jurisdiction or any devices intended for implantation in the human body. Should Buyer purchase or use **onsemi** products for any such unintended or unauthorized application, Buyer shall indemnify and hold **onsemi** and its officers, employees, subsidiaries, affiliates, and distributors harmless against all claims, costs, damages, and expenses, and reasonable attorney fees arising out of, directly or indirectly, any claim of personal injury or death associated with such unintended or unauthorized use, even if such claim alleges that **onsemi** was negligent regarding the design or manufacture of the part. **onsemi** is an Equal Opportunity/Affirmative Action Employer. This literature is subject to all applicable copyright laws and is not for resale in any manner.

## PUBLICATION ORDERING INFORMATION

### LITERATURE FULFILLMENT:

Email Requests to: [orderlit@onsemi.com](mailto:orderlit@onsemi.com)

**onsemi Website:** [www.onsemi.com](http://www.onsemi.com)

### TECHNICAL SUPPORT

**North American Technical Support:**

Voice Mail: 1 800-282-9855 Toll Free USA/Canada

Phone: 011 421 33 790 2910

**Europe, Middle East and Africa Technical Support:**

Phone: 00421 33 790 2910

For additional information, please contact your local Sales Representative