

# Schottky Barrier Rectifier, Trench-based

## NRTS1260PFS, NRVTS1260PFS

This TO-277 trench Schottky rectifier provides fast switching performance in a compact thermally efficient package. The TO-277 package provides an excellent alternative to the DPAK, offering thermal performance nearly as good in a package occupying less than half the board space. Its low profile makes it a good option for flat panel display and other applications with limited vertical clearance. The device offers low leakage over temperature making it a good match for applications requiring low quiescent current.

### Features

- Package Provides Capability of Inspection and Probe After Board Mounting
- Low Forward Voltage Drop
- 175°C Operating Junction Temperature
- NRV Prefix for Automotive and Other Applications Requiring Unique Site and Control Change Requirements; AEC-Q101 Qualified and PPAP Capable
- These Devices are Pb-Free, Halogen Free/BFR Free and are RoHS Compliant

### Mechanical Characteristics

- Case: Epoxy, Molded
- Epoxy Meets Flammability Rating UL 94-0 @ 0.125 in.
- Lead Finish: 100% Matte Sn (Tin)
- Lead and Mounting Surface Temperature for Soldering Purposes: 260°C Max. for 10 Seconds
- Device Meets MSL 1 Requirements

### Applications

- Excellent Alternative to DPAK in Space-Constrained Automotive Applications
- Low Leakage for Higher Temperature Operation
- Output Rectification in Compact Portable Consumer Applications
- Freewheeling Diode used with Inductive Loads



ON Semiconductor®

[www.onsemi.com](http://www.onsemi.com)

## SCHOTTKY BARRIER RECTIFIER, 12 AMPERES 60 VOLTS

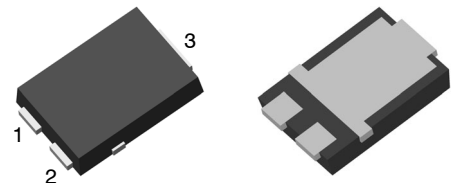

TO-277-3LD  
CASE 340CZ

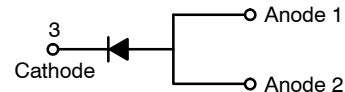

### MARKING DIAGRAM

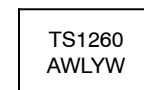

TS1260 = Specific Device Code  
A = Assembly Location  
Y = Year  
W = Work Week  
WL = Wafer Lot

### ORDERING INFORMATION

| Device          | Package             | Shipping†             |
|-----------------|---------------------|-----------------------|
| NRTS1260PFST3G  | TO-277<br>(Pb-Free) | 1500 /<br>Tape & Reel |
| NRVTS1260PFST3G | TO-277<br>(Pb-Free) | 1500 /<br>Tape & Reel |

†For information on tape and reel specifications, including part orientation and tape sizes, please refer to our Tape and Reel Packaging Specification Brochure, BRD8011/D.

# NRTS1260PFS, NRVTS1260PFS

## MAXIMUM RATINGS

| Rating  | Symbol                          | Value       | Unit             |
|---|---------------------------------|-------------|------------------|
| Peak Repetitive Reverse Voltage<br>Working Peak Reverse Voltage<br>DC Blocking Voltage                      | $V_{RRM}$<br>$V_{RWM}$<br>$V_R$ | 60          | V                |
| Average Rectified Forward Current<br>( $T_C = 161^\circ\text{C}$ )  | $I_{F(AV)}$                     | 12          | A                |
| Peak Repetitive Forward Current,<br>( $T_C = 157^\circ\text{C}$ , Square Wave, Duty = 0.5)                  | $I_{FRM}$                       | 24          | A                |
| Non-Repetitive Peak Surge Current<br>(Surge Applied at Rated Load Conditions Halfwave, Single Phase, 60 Hz) | $I_{FSM}$                       | 150         | A                |
| Storage Temperature Range   | $T_{stg}$                       | -65 to +175 | $^\circ\text{C}$ |
| Operating Junction Temperature  | $T_J$                           | -55 to +175 | $^\circ\text{C}$ |
| ESD Rating (Human Body Model)   |                                 | 3B          |                  |
| ESD Rating (Machine Model)  |                                 | M4          |                  |

Stresses exceeding those listed in the Maximum Ratings table may damage the device. If any of these limits are exceeded, device functionality should not be assumed, damage may occur and reliability may be affected.

## THERMAL CHARACTERISTICS

| Characteristic   | Symbol           | Max  | Unit                      |
|--|------------------|------|---------------------------|
| Thermal Resistance, Junction-to-Ambient<br>(Assumes 600 mm <sup>2</sup> , 1 oz. copper bond pad on a FR4 board)      | $R_{\theta JA}$  | 69   | $^\circ\text{C}/\text{W}$ |
| Thermal Resistance, Junction-to-Case, Top<br>(Assumes 600 mm <sup>2</sup> , 1 oz. copper bond pad on a FR4 board)    | $R_{\theta JCT}$ | 60   | $^\circ\text{C}/\text{W}$ |
| Thermal Resistance, Junction-to-Case, Bottom<br>(Assumes 600 mm <sup>2</sup> , 1 oz. copper bond pad on a FR4 board) | $R_{\theta JCB}$ | 1.92 | $^\circ\text{C}/\text{W}$ |

## ELECTRICAL CHARACTERISTICS

| Characteristic   | Symbol | Typ                          | Max                    | Unit                |
|--|--------|------------------------------|------------------------|---------------------|
| Instantaneous Forward Voltage (Note 1)<br>( $I_F = 6\text{ A}$ , $T_J = 25^\circ\text{C}$ )<br>( $I_F = 6\text{ A}$ , $T_J = 125^\circ\text{C}$ )<br>( $I_F = 12\text{ A}$ , $T_J = 25^\circ\text{C}$ )<br>( $I_F = 12\text{ A}$ , $T_J = 125^\circ\text{C}$ ) | $V_F$  | 0.50<br>0.43<br>0.58<br>0.55 | -<br>-<br>0.66<br>0.64 | V                   |
| Instantaneous Reverse Current (Note 1)<br>(Rated dc Voltage, $T_J = 25^\circ\text{C}$ )<br>(Rated dc Voltage, $T_J = 125^\circ\text{C}$ )  | $i_R$  | 7.5<br>5.1                   | 350<br>60              | $\mu\text{A}$<br>mA |
| Junction Capacitance<br>( $V_R = 1\text{ V}$ , $T_J = 25^\circ\text{C}$ , 1 MHz)   | $C_J$  | 1180                         | -                      | pF                  |

Product parametric performance is indicated in the Electrical Characteristics for the listed test conditions, unless otherwise noted. Product performance may not be indicated by the Electrical Characteristics if operated under different conditions.

1. Pulse Test: Pulse Width = 300  $\mu\text{s}$ , Duty Cycle  $\leq 2.0\%$ .

TYPICAL CHARACTERISTICS

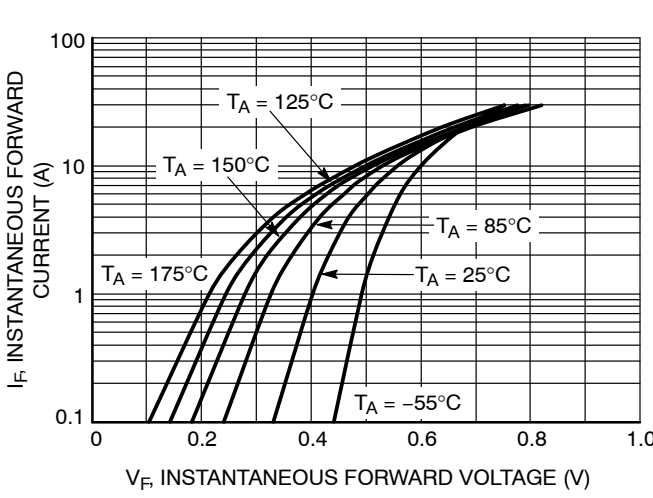

Figure 1. Typical Instantaneous Forward Characteristics

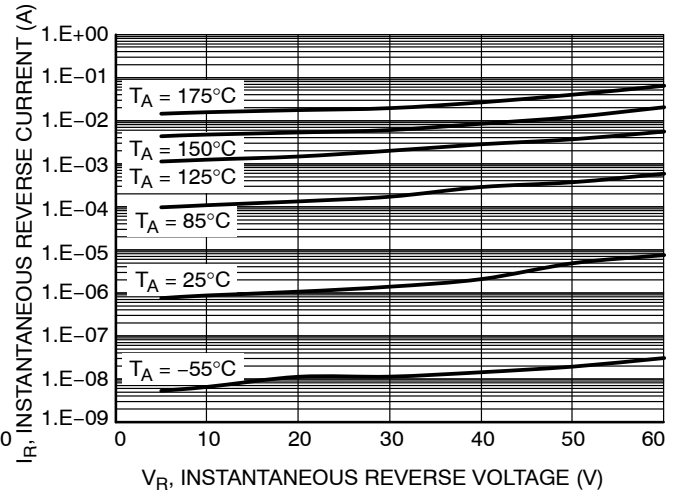

Figure 2. Typical Reverse Characteristics

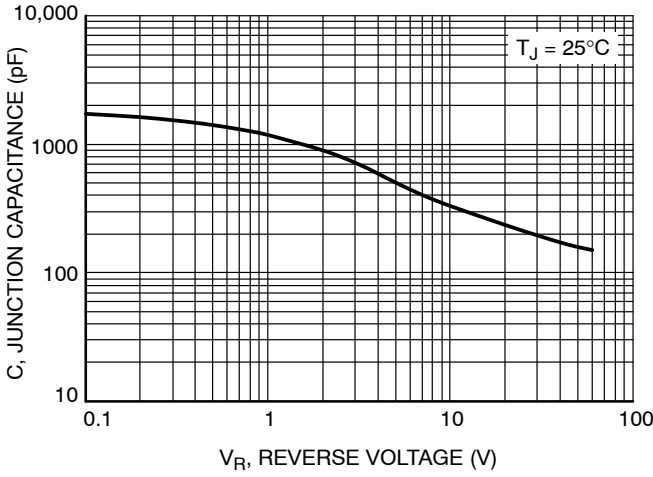

Figure 3. Typical Junction Capacitance

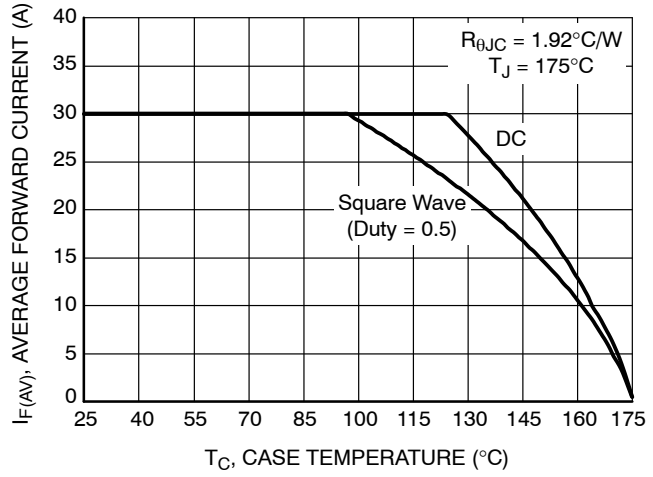

Figure 4. Current Derating

# NRTS1260PFS, NRVTS1260PFS

## TYPICAL CHARACTERISTICS

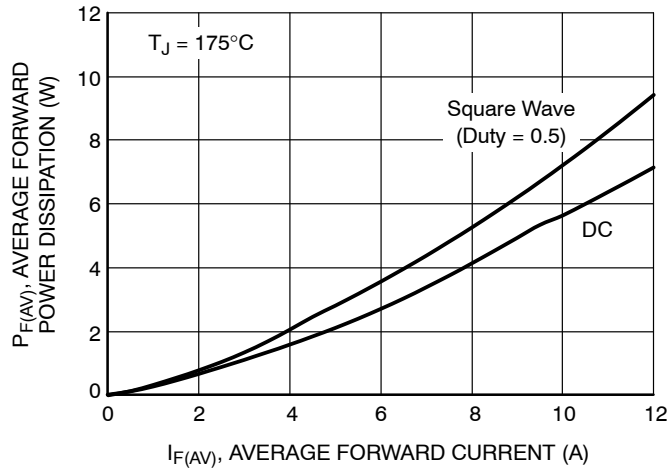

Figure 5. Forward Power Dissipation

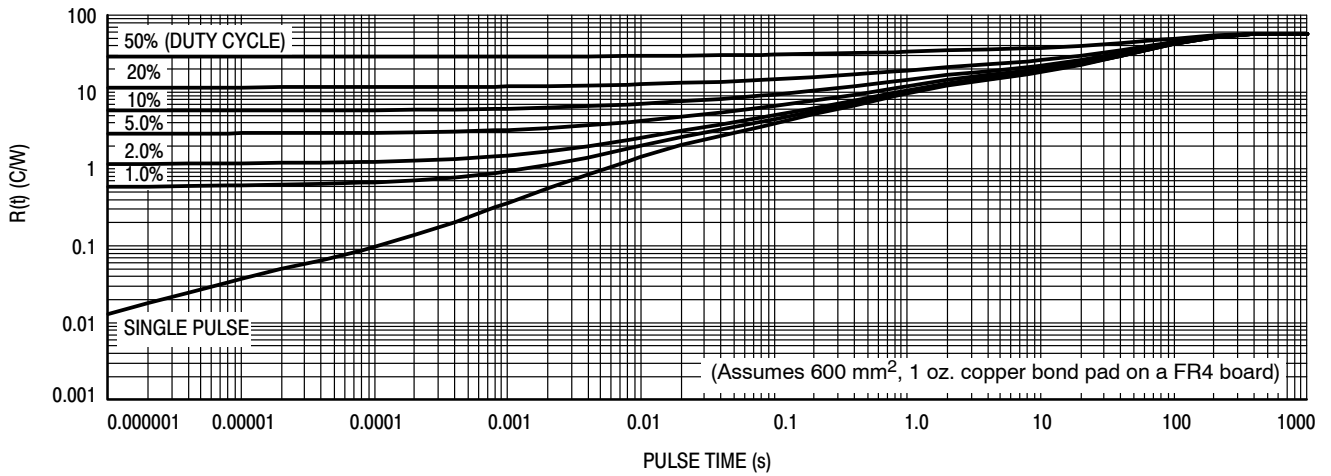

Figure 6. Typical Thermal Characteristics, Junction-to-Ambient



**TO-277-3LD**  
**CASE 340CZ**  
**ISSUE A**

DATE 14 FEB 2020

NOTES:

1. DIMENSIONING AND TOLERANCING PER ASME Y14.5M, 1994.
2. CONTROLLING DIMENSION: MILLIMETERS
3. DIMENSIONS b, b1, b2, b3, b6 AND c TO BE MEASURED ON FLAT SECTION OF THE LEAD, BETWEEN 0.13 AND 0.25mm FROM LEAD TIP.
4. COPLANARITY APPLIES TO THE EXPOSED PAD AS WELL AS THE TERMINALS.
5. POSITIONAL TOLERANCE APPLIES TO THE TERMINALS AND EXPOSED PAD.
6. A1 IS DEFINED AS THE VERTICAL DISTANCE FROM THE SEATING PLANE TO THE LOWEST POINT ON THE PACKAGE BODY.
7. DIMENSIONS D AND E TO BE DETERMINED AT DATUM PLANE C.

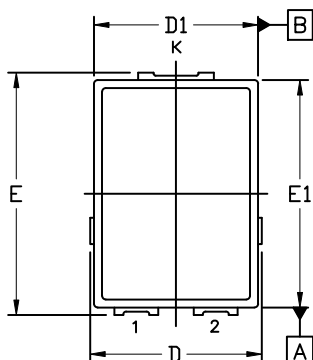

TOP VIEW

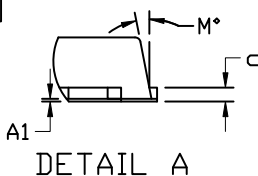

DETAIL A

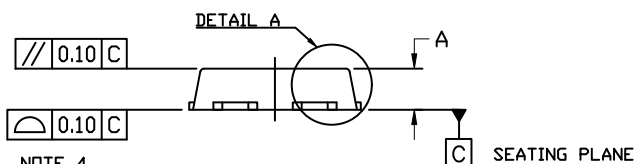

FRONT VIEW

NOTE 4

| DIM | MILLIMETERS |      |      |
|-----|-------------|------|------|
|     | MIN.        | NDM. | MAX. |
| A   | 1.00        | 1.10 | 1.20 |
| A1  | ---         | 0.01 | 0.05 |
| b   | 1.13        | 1.18 | 1.28 |
| b1  | 0.70 REF    |      |      |
| b2  | 1.98        | 2.03 | 2.13 |
| b3  | 1.20 REF    |      |      |
| b4  | 0.71 REF    |      |      |
| c   | 0.20 REF    |      |      |
| D   | 4.45        | 4.60 | 4.75 |
| D1  | 4.35        | 4.40 | 4.45 |
| D2  | 3.50        | 3.60 | 3.70 |

| DIM | MILLIMETERS |      |      |
|-----|-------------|------|------|
|     | MIN.        | NDM. | MAX. |
| E   | 6.35        | 6.50 | 6.65 |
| E1  | 6.05        | 6.10 | 6.15 |
| E2  | 4.50        | 4.60 | 4.70 |
| E3  | 3.84        | 3.94 | 4.04 |
| E4  | 0.98 REF    |      |      |
| e   | 2.13 BSC    |      |      |
| K   | 0.85 REF    |      |      |
| K1  | 0.40 REF    |      |      |
| L   | 0.90        | 1.05 | 1.20 |
| L1  | 0.02        | ---  | ---  |
| M   | ---         | ---  | 12°  |

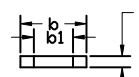

SECTION A-A

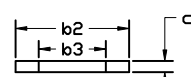

SECTION B-B

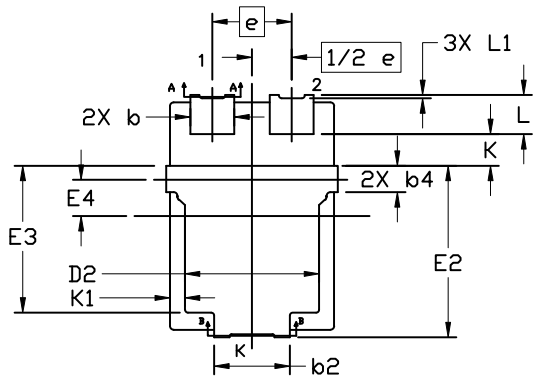

BOTTOM VIEW

|   |      |     |   |   |   |
|---|------|-----|---|---|---|
| ⊕ | 0.13 | (M) | C | A | B |
|   | 0.07 | (M) | C |   |   |

NOTE 4

**GENERIC MARKING DIAGRAM\***

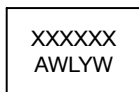

- XXXXXX = Specific Device Code
- A = Assembly Location
- Y = Year
- W = Work Week
- WL = Wafer Lot

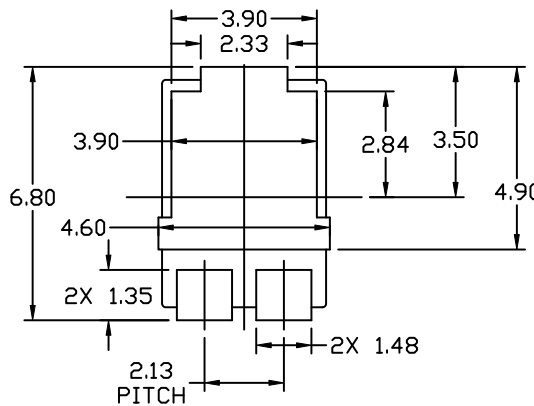

RECOMMENDED MOUNTING FOOTPRINT

\* For additional information on our Pb-Free strategy and soldering details, please download the ON Semiconductor Soldering and Mounting Techniques Reference Manual, [SOLDDRM/D](#).

\*This information is generic. Please refer to device data sheet for actual part marking. Pb-Free indicator, "G" or microdot "•", may or may not be present. Some products may not follow the Generic Marking.

|                         |                    |  |
|-------------------------|--------------------|--|
| <b>DOCUMENT NUMBER:</b> | <b>98AON97727G</b> | Electronic versions are uncontrolled except when accessed directly from the Document Repository. Printed versions are uncontrolled except when stamped "CONTROLLED COPY" in red. |
| <b>DESCRIPTION:</b>     | <b>TO-277-3LD</b>  | <b>PAGE 1 OF 1</b>   |

ON Semiconductor and are trademarks of Semiconductor Components Industries, LLC dba ON Semiconductor or its subsidiaries in the United States and/or other countries. ON Semiconductor reserves the right to make changes without further notice to any products herein. ON Semiconductor makes no warranty, representation or guarantee regarding the suitability of its products for any particular purpose, nor does ON Semiconductor assume any liability arising out of the application or use of any product or circuit, and specifically disclaims any and all liability, including without limitation special, consequential or incidental damages. ON Semiconductor does not convey any license under its patent rights nor the rights of others.

**onsemi**, **Onsemi**, and other names, marks, and brands are registered and/or common law trademarks of Semiconductor Components Industries, LLC dba "**onsemi**" or its affiliates and/or subsidiaries in the United States and/or other countries. **onsemi** owns the rights to a number of patents, trademarks, copyrights, trade secrets, and other intellectual property. A listing of **onsemi**'s product/patent coverage may be accessed at [www.onsemi.com/site/pdf/Patent-Marking.pdf](http://www.onsemi.com/site/pdf/Patent-Marking.pdf). **onsemi** reserves the right to make changes at any time to any products or information herein, without notice. The information herein is provided "as-is" and **onsemi** makes no warranty, representation or guarantee regarding the accuracy of the information, product features, availability, functionality, or suitability of its products for any particular purpose, nor does **onsemi** assume any liability arising out of the application or use of any product or circuit, and specifically disclaims any and all liability, including without limitation special, consequential or incidental damages. Buyer is responsible for its products and applications using **onsemi** products, including compliance with all laws, regulations and safety requirements or standards, regardless of any support or applications information provided by **onsemi**. "Typical" parameters which may be provided in **onsemi** data sheets and/or specifications can and do vary in different applications and actual performance may vary over time. All operating parameters, including "Typicals" must be validated for each customer application by customer's technical experts. **onsemi** does not convey any license under any of its intellectual property rights nor the rights of others. **onsemi** products are not designed, intended, or authorized for use as a critical component in life support systems or any FDA Class 3 medical devices or medical devices with a same or similar classification in a foreign jurisdiction or any devices intended for implantation in the human body. Should Buyer purchase or use **onsemi** products for any such unintended or unauthorized application, Buyer shall indemnify and hold **onsemi** and its officers, employees, subsidiaries, affiliates, and distributors harmless against all claims, costs, damages, and expenses, and reasonable attorney fees arising out of, directly or indirectly, any claim of personal injury or death associated with such unintended or unauthorized use, even if such claim alleges that **onsemi** was negligent regarding the design or manufacture of the part. **onsemi** is an Equal Opportunity/Affirmative Action Employer. This literature is subject to all applicable copyright laws and is not for resale in any manner.

## PUBLICATION ORDERING INFORMATION

### LITERATURE FULFILLMENT:

Email Requests to: [orderlit@onsemi.com](mailto:orderlit@onsemi.com)

**onsemi Website:** [www.onsemi.com](http://www.onsemi.com)

### TECHNICAL SUPPORT

**North American Technical Support:**

Voice Mail: 1 800-282-9855 Toll Free USA/Canada

Phone: 011 421 33 790 2910

**Europe, Middle East and Africa Technical Support:**

Phone: 00421 33 790 2910

For additional information, please contact your local Sales Representative