

NTMFD5C446NL

MOSFET – Power, Dual, N-Channel 40 V, 2.65 mΩ, 145 A

Features

- Small Footprint (5x6 mm) for Compact Design
- Low $R_{DS(on)}$ to Minimize Conduction Losses
- Low Q_G and Capacitance to Minimize Driver Losses
- These Devices are Pb-Free, Halogen Free/BFR Free and are RoHS Compliant

MAXIMUM RATINGS ($T_J = 25^\circ\text{C}$ unless otherwise noted)

Parameter	Symbol	Value	Unit	
Drain-to-Source Voltage	V_{DSS}	40	V	
Gate-to-Source Voltage	V_{GS}	± 20	V	
Continuous Drain Current $R_{\theta JC}$ (Notes 1, 2, 3)	Steady State	$T_C = 25^\circ\text{C}$	I_D 145	A
		$T_C = 100^\circ\text{C}$	105	
Power Dissipation $R_{\theta JC}$ (Notes 1, 2)	Steady State	$T_C = 25^\circ\text{C}$	P_D 125	W
		$T_C = 100^\circ\text{C}$	62	
Continuous Drain Current $R_{\theta JA}$ (Notes 1, 2, 3)	Steady State	$T_A = 25^\circ\text{C}$	I_D 25	A
		$T_A = 100^\circ\text{C}$	18	
Power Dissipation $R_{\theta JA}$ (Notes 1 & 2)	Steady State	$T_A = 25^\circ\text{C}$	P_D 3.5	W
		$T_A = 100^\circ\text{C}$	1.8	
Pulsed Drain Current	$T_A = 25^\circ\text{C}, t_p = 10 \mu\text{s}$	I_{DM} 644	A	
Operating Junction and Storage Temperature	T_J, T_{stg}	-55 to +175	$^\circ\text{C}$	
Source Current (Body Diode)	I_S	91	A	
Single Pulse Drain-to-Source Avalanche Energy ($I_{L(pk)} = 11 \text{ A}$)	E_{AS}	171	mJ	
Lead Temperature for Soldering Purposes (1/8" from case for 10 s)	T_L	260	$^\circ\text{C}$	

Stresses exceeding those listed in the Maximum Ratings table may damage the device. If any of these limits are exceeded, device functionality should not be assumed, damage may occur and reliability may be affected.

THERMAL RESISTANCE MAXIMUM RATINGS

Parameter	Symbol	Value	Unit
Junction-to-Case – Steady State	$R_{\theta JC}$	1.38	$^\circ\text{C}/\text{W}$
Junction-to-Ambient – Steady State (Note 2)	$R_{\theta JA}$	46.9	

1. The entire application environment impacts the thermal resistance values shown, they are not constants and are only valid for the particular conditions noted.
2. Surface-mounted on FR4 board using a 650 mm², 2 oz. Cu pad.
3. Maximum current for pulses as long as 1 second is higher but is dependent on pulse duration and duty cycle.



ON Semiconductor®

www.onsemi.com

$V_{(BR)DSS}$	$R_{DS(on)}$ MAX	I_D MAX
40 V	2.65 mΩ @ 10 V	145 A
	3.9 mΩ @ 4.5 V	

Dual N-Channel

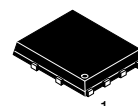
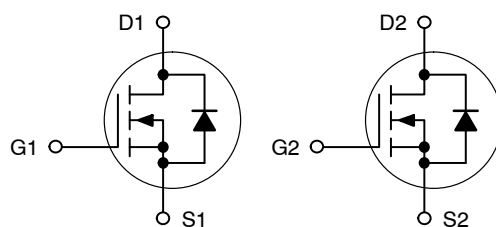

DFN8 5x6 (SO8FL) CASE 506BT

MARKING DIAGRAM

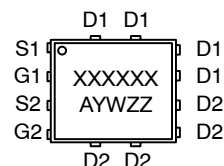

- A = Assembly Location
- Y = Year
- W = Work Week
- ZZ = Lot Traceability

ORDERING INFORMATION

See detailed ordering, marking and shipping information in the package dimensions section on page 5 of this data sheet.

NTMFD5C446NL

ELECTRICAL CHARACTERISTICS ($T_J = 25^\circ\text{C}$ unless otherwise specified)

Parameter	Symbol	Test Condition	Min	Typ	Max	Unit
OFF CHARACTERISTICS						
Drain-to-Source Breakdown Voltage	$V_{(BR)DSS}$	$V_{GS} = 0\text{ V}, I_D = 250\ \mu\text{A}$	40			V
Drain-to-Source Breakdown Voltage Temperature Coefficient	$V_{(BR)DSS}/T_J$			23		mV/°C
Zero Gate Voltage Drain Current	I_{DSS}	$V_{GS} = 0\text{ V}, V_{DS} = 40\text{ V}$	$T_J = 25\ ^\circ\text{C}$		10	μA
			$T_J = 125^\circ\text{C}$		100	
Gate-to-Source Leakage Current	I_{GSS}	$V_{DS} = 0\text{ V}, V_{GS} = 20\text{ V}$			100	nA

ON CHARACTERISTICS (Note 4)

Gate Threshold Voltage	$V_{GS(TH)}$	$V_{GS} = V_{DS}, I_D = 90\ \mu\text{A}$	1.2		2.2	V
Negative Threshold Temperature Coefficient	$V_{GS(TH)}/T_J$			-5.2		mV/°C
Drain-to-Source On Resistance	$R_{DS(on)}$	$V_{GS} = 10\text{ V}, I_D = 20\text{ A}$		2.2	2.65	m Ω
		$V_{GS} = 4.5\text{ V}, I_D = 20\text{ A}$		3.0	3.9	
Forward Transconductance	g_{FS}	$V_{DS} = 15\text{ V}, I_D = 50\text{ A}$		138		S

CHARGES, CAPACITANCES & GATE RESISTANCE

Input Capacitance	C_{ISS}	$V_{GS} = 0\text{ V}, f = 1\text{ MHz}, V_{DS} = 25\text{ V}$		3170		pF
Output Capacitance	C_{OSS}			1270		
Reverse Transfer Capacitance	C_{RSS}			48		
Total Gate Charge	$Q_{G(TOT)}$	$V_{GS} = 4.5\text{ V}, V_{DS} = 32\text{ V}, I_D = 50\text{ A}$		25		nC
Total Gate Charge	$Q_{G(TOT)}$	$V_{GS} = 10\text{ V}, V_{DS} = 32\text{ V}, I_D = 50\text{ A}$		54		
Threshold Gate Charge	$Q_{G(TH)}$	$V_{GS} = 4.5\text{ V}, V_{DS} = 32\text{ V}, I_D = 50\text{ A}$		5.7		
Gate-to-Source Charge	Q_{GS}			10.7		
Gate-to-Drain Charge	Q_{GD}			7.0		
Plateau Voltage	V_{GP}			5.7		V

SWITCHING CHARACTERISTICS (Note 5)

Turn-On Delay Time	$t_{d(ON)}$	$V_{GS} = 4.5\text{ V}, V_{DS} = 32\text{ V}, I_D = 5\text{ A}, R_G = 1.0\ \Omega$		14.8		ns
Rise Time	t_r			16.8		
Turn-Off Delay Time	$t_{d(OFF)}$			34.9		
Fall Time	t_f			15.2		

DRAIN-SOURCE DIODE CHARACTERISTICS

Forward Diode Voltage	V_{SD}	$V_{GS} = 0\text{ V}, I_S = 20\text{ A}$	$T_J = 25^\circ\text{C}$		0.8	V
			$T_J = 125^\circ\text{C}$		0.7	
Reverse Recovery Time	t_{RR}	$V_{GS} = 0\text{ V}, dI_S/dt = 50\text{ A}/\mu\text{s}, I_S = 5\text{ A}$		54		ns
Charge Time	t_a			24		
Discharge Time	t_b			30		
Reverse Recovery Charge	Q_{RR}				55	

Product parametric performance is indicated in the Electrical Characteristics for the listed test conditions, unless otherwise noted. Product performance may not be indicated by the Electrical Characteristics if operated under different conditions.

4. Pulse Test: pulse width $\leq 300\ \mu\text{s}$, duty cycle $\leq 2\%$.

5. Switching characteristics are independent of operating junction temperatures.

NTMFD5C446NL

TYPICAL CHARACTERISTICS

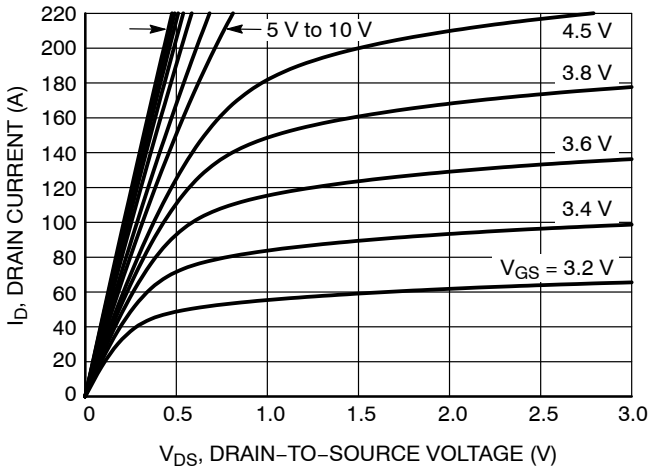

Figure 1. On-Region Characteristics

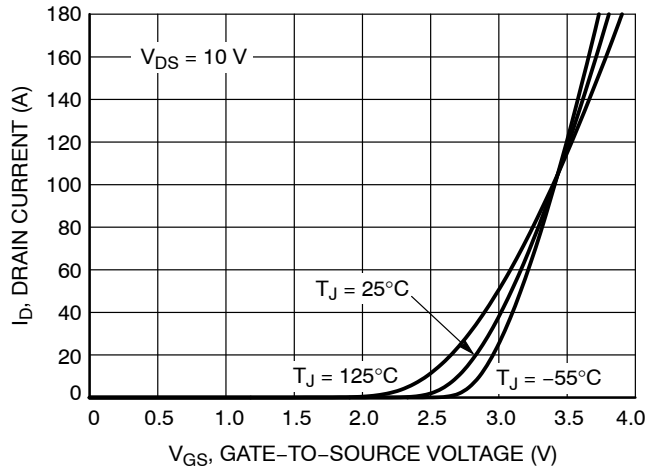

Figure 2. Transfer Characteristics

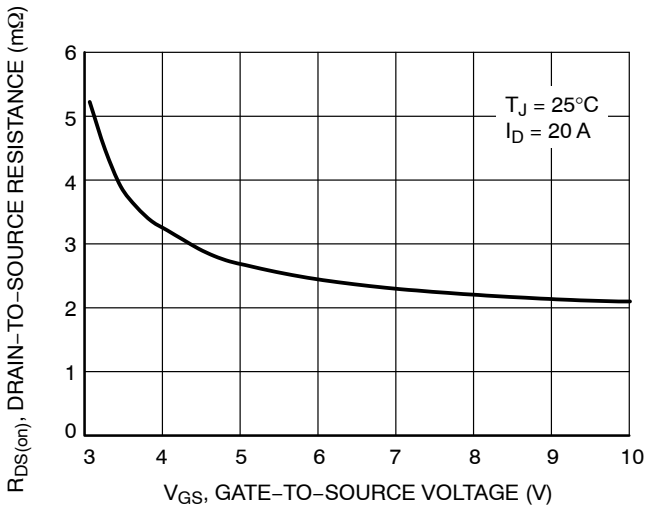

Figure 3. On-Resistance vs. Gate-to-Source Voltage

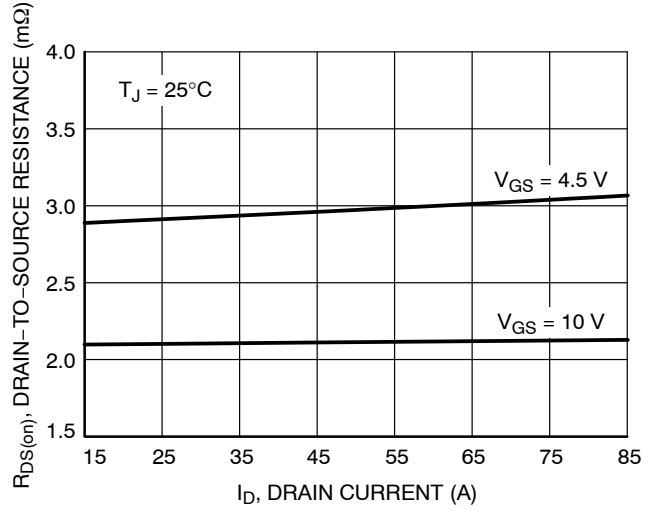

Figure 4. On-Resistance vs. Drain Current and Gate Voltage

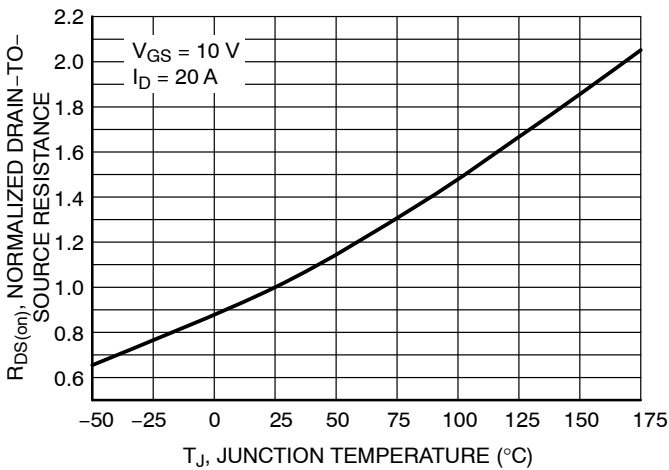

Figure 5. On-Resistance Variation with Temperature

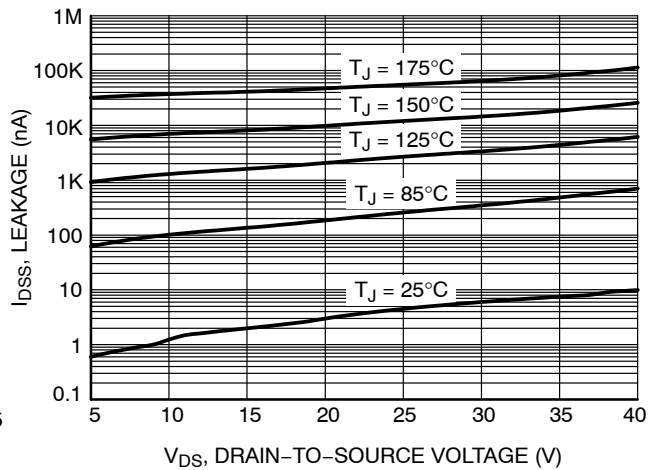

Figure 6. Drain-to-Source Leakage Current vs. Voltage

NTMFD5C446NL

TYPICAL CHARACTERISTICS

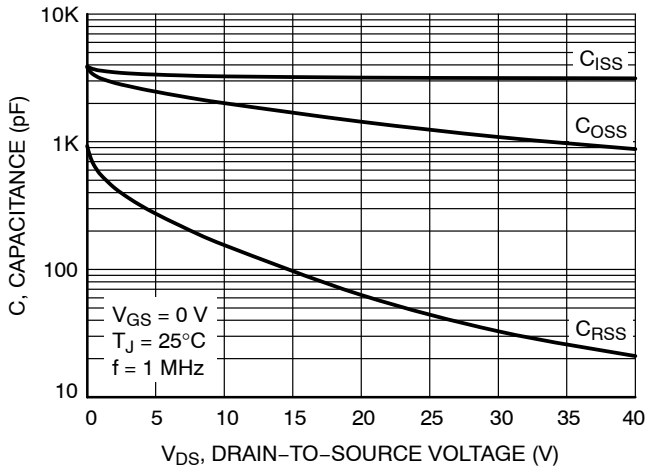

Figure 7. Capacitance Variation

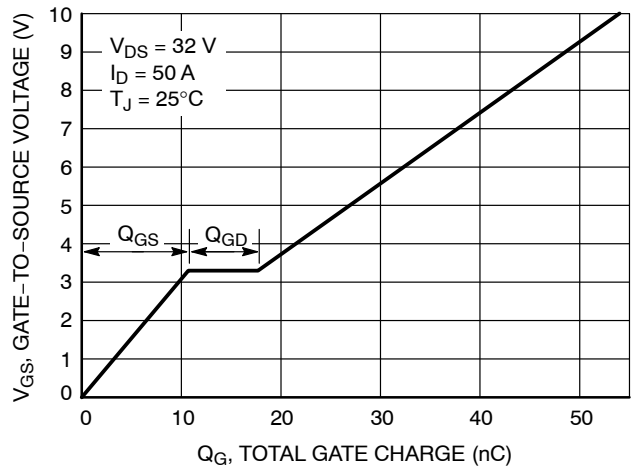

Figure 8. Gate-to-Source vs. Total Charge

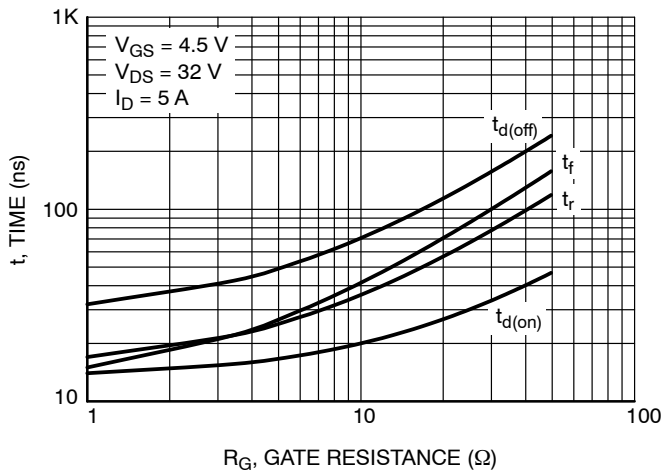

Figure 9. Resistive Switching Time Variation vs. Gate Resistance

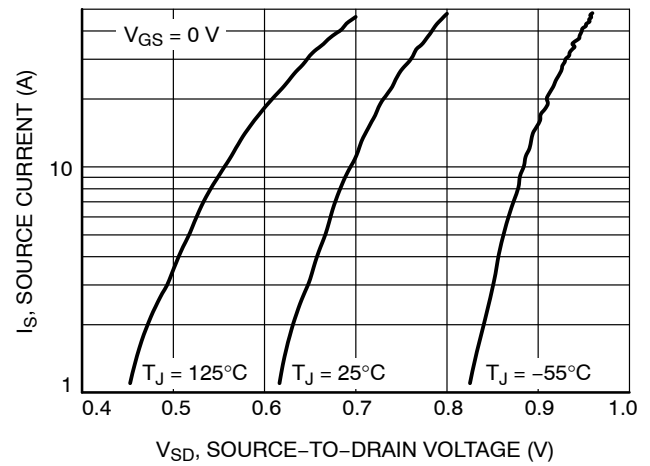

Figure 10. Diode Forward Voltage vs. Current

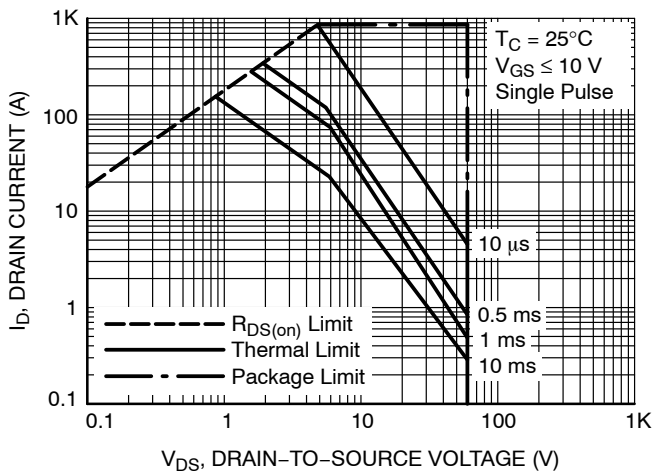

Figure 11. Maximum Rated Forward Biased Safe Operating Area

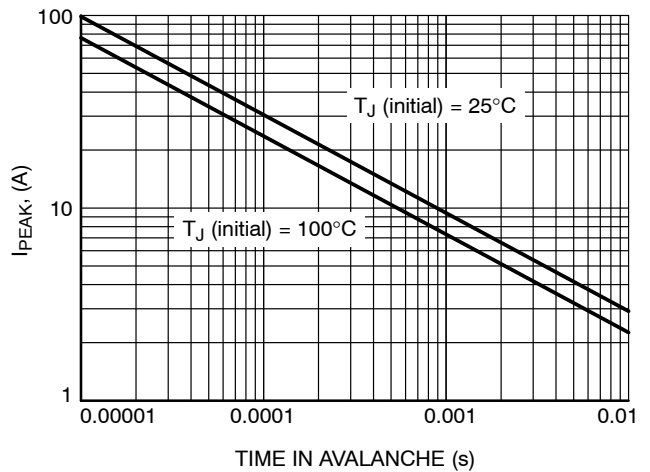

Figure 12. I_{PEAK} vs. Time in Avalanche

NTMFD5C446NL

TYPICAL CHARACTERISTICS

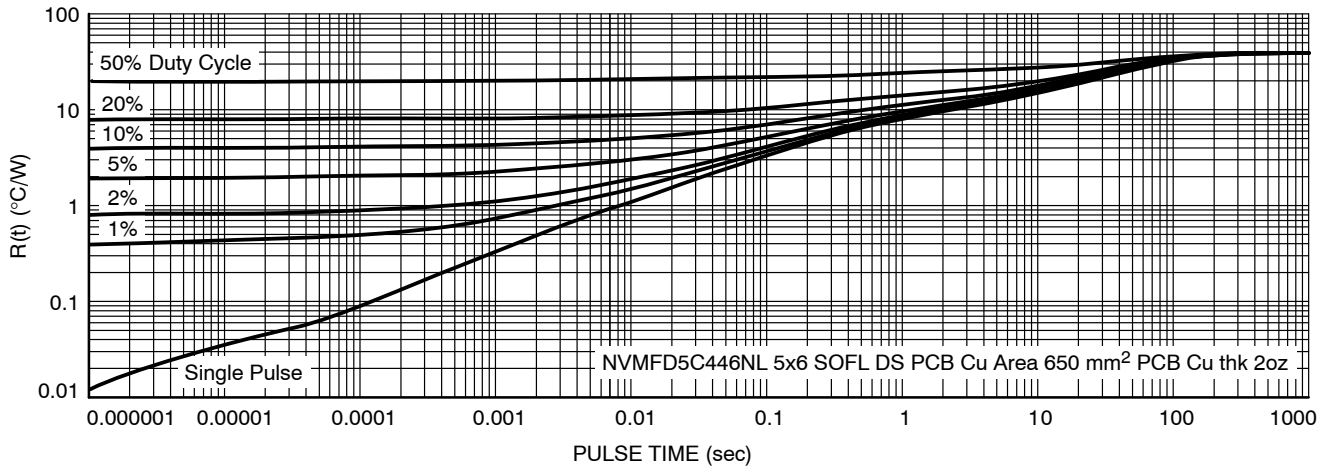

Figure 13. Thermal Characteristics

DEVICE ORDERING INFORMATION

Device	Marking	Package	Shipping [†]
NTMFD5C446NLT1G	5C446L	DFN8 (Pb-Free)	1500 / Tape & Reel

[†]For information on tape and reel specifications, including part orientation and tape sizes, please refer to our Tape and Reel Packaging Specifications Brochure, BRD8011/D.

MECHANICAL CASE OUTLINE PACKAGE DIMENSIONS



SCALE 2:1

DFN8 5x6, 1.27P Dual Flag (SO8FL-Dual) CASE 506BT ISSUE F

DATE 23 NOV 2021

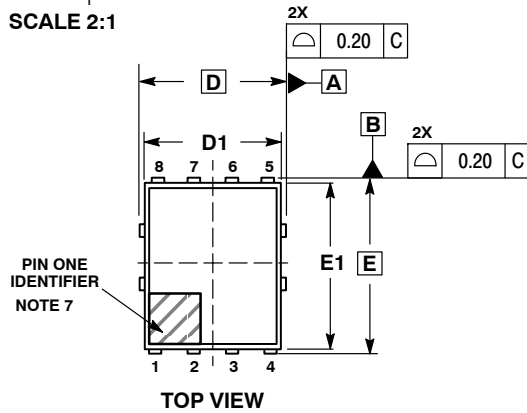

TOP VIEW

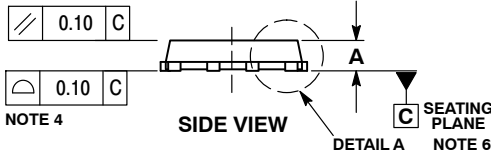

SIDE VIEW

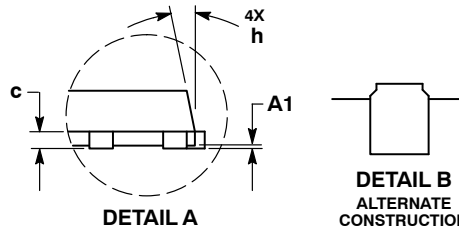

DETAIL A

DETAIL B
ALTERNATE
CONSTRUCTION

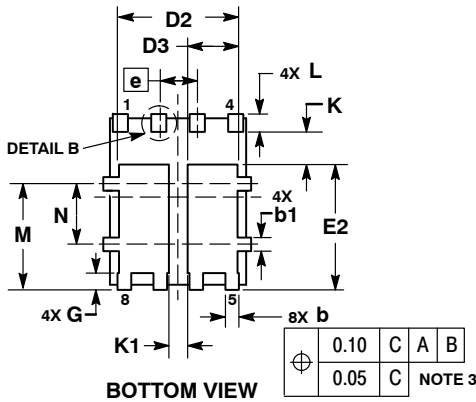

BOTTOM VIEW

GENERIC MARKING DIAGRAM*

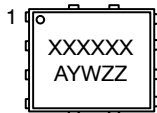

XXXXXX = Specific Device Code
A = Assembly Location
Y = Year
W = Work Week
ZZ = Lot Traceability

*This information is generic. Please refer to device data sheet for actual part marking. Pb-Free indicator, "G" or microdot "•", may or may not be present. Some products may not follow the Generic Marking.

- NOTES:
1. DIMENSIONING AND TOLERANCING PER ASME Y14.5M, 1994.
 2. CONTROLLING DIMENSION: MILLIMETERS.
 3. DIMENSION b APPLIES TO PLATED TERMINAL AND IS MEASURED BETWEEN 0.15 AND 0.30 MM FROM THE TERMINAL TIP.
 4. PROFILE TOLERANCE APPLIES TO THE EXPOSED PAD AS WELL AS THE TERMINALS.
 5. DIMENSIONS D1 AND E1 DO NOT INCLUDE MOLD FLASH, PROTRUSIONS, OR GATE BURRS.
 6. SEATING PLANE IS DEFINED BY THE TERMINALS. A1 IS DEFINED AS THE DISTANCE FROM THE SEATING PLANE TO THE LOWEST POINT ON THE PACKAGE BODY.
 7. A VISUAL INDICATOR FOR PIN 1 MUST BE LOCATED IN THIS AREA.

DIM	MILLIMETERS		
	MIN	NOM	MAX
A	0.90	---	1.10
A1	---	---	0.05
b	0.33	0.42	0.51
b1	0.33	0.42	0.51
c	0.20	---	0.33
D	5.15 BSC		
D1	4.70	4.90	5.10
D2	3.90	4.10	4.30
D3	1.50	1.70	1.90
E	6.15 BSC		
E1	5.70	5.90	6.10
E2	3.90	4.15	4.40
e	1.27 BSC		
G	0.45	0.55	0.65
h	---	---	12 °
K	0.51	---	---
K1	0.56	---	---
L	0.48	0.61	0.71
M	3.25	3.50	3.75
N	1.80	2.00	2.20

SOLDERING FOOTPRINT*

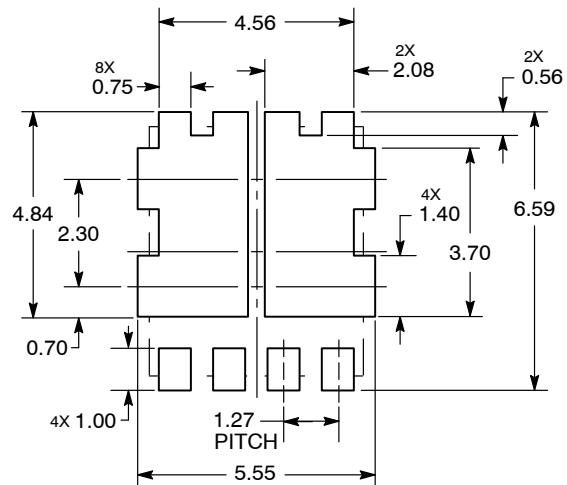

DIMENSION: MILLIMETERS

*For additional information on our Pb-Free strategy and soldering details, please download the ON Semiconductor Soldering and Mounting Techniques Reference Manual, SOLDERRM/D.

DOCUMENT NUMBER:	98AON50417E	Electronic versions are uncontrolled except when accessed directly from the Document Repository. Printed versions are uncontrolled except when stamped "CONTROLLED COPY" in red.
DESCRIPTION:	DFN8 5X6, 1.27P DUAL FLAG (SO8FL-DUAL)	PAGE 1 OF 1

onsemi and ONSEMI are trademarks of Semiconductor Components Industries, LLC dba onsemi or its subsidiaries in the United States and/or other countries. onsemi reserves the right to make changes without further notice to any products herein. onsemi makes no warranty, representation or guarantee regarding the suitability of its products for any particular purpose, nor does onsemi assume any liability arising out of the application or use of any product or circuit, and specifically disclaims any and all liability, including without limitation special, consequential or incidental damages. onsemi does not convey any license under its patent rights nor the rights of others.

onsemi, **Onsemi**, and other names, marks, and brands are registered and/or common law trademarks of Semiconductor Components Industries, LLC dba "**onsemi**" or its affiliates and/or subsidiaries in the United States and/or other countries. **onsemi** owns the rights to a number of patents, trademarks, copyrights, trade secrets, and other intellectual property. A listing of **onsemi**'s product/patent coverage may be accessed at www.onsemi.com/site/pdf/Patent-Marking.pdf. **onsemi** reserves the right to make changes at any time to any products or information herein, without notice. The information herein is provided "as-is" and **onsemi** makes no warranty, representation or guarantee regarding the accuracy of the information, product features, availability, functionality, or suitability of its products for any particular purpose, nor does **onsemi** assume any liability arising out of the application or use of any product or circuit, and specifically disclaims any and all liability, including without limitation special, consequential or incidental damages. Buyer is responsible for its products and applications using **onsemi** products, including compliance with all laws, regulations and safety requirements or standards, regardless of any support or applications information provided by **onsemi**. "Typical" parameters which may be provided in **onsemi** data sheets and/or specifications can and do vary in different applications and actual performance may vary over time. All operating parameters, including "Typicals" must be validated for each customer application by customer's technical experts. **onsemi** does not convey any license under any of its intellectual property rights nor the rights of others. **onsemi** products are not designed, intended, or authorized for use as a critical component in life support systems or any FDA Class 3 medical devices or medical devices with a same or similar classification in a foreign jurisdiction or any devices intended for implantation in the human body. Should Buyer purchase or use **onsemi** products for any such unintended or unauthorized application, Buyer shall indemnify and hold **onsemi** and its officers, employees, subsidiaries, affiliates, and distributors harmless against all claims, costs, damages, and expenses, and reasonable attorney fees arising out of, directly or indirectly, any claim of personal injury or death associated with such unintended or unauthorized use, even if such claim alleges that **onsemi** was negligent regarding the design or manufacture of the part. **onsemi** is an Equal Opportunity/Affirmative Action Employer. This literature is subject to all applicable copyright laws and is not for resale in any manner.

PUBLICATION ORDERING INFORMATION

LITERATURE FULFILLMENT:

Email Requests to: orderlit@onsemi.com

onsemi Website: www.onsemi.com

TECHNICAL SUPPORT

North American Technical Support:

Voice Mail: 1 800-282-9855 Toll Free USA/Canada

Phone: 011 421 33 790 2910

Europe, Middle East and Africa Technical Support:

Phone: 00421 33 790 2910

For additional information, please contact your local Sales Representative