

General Purpose Transistors

NPN Silicon

NST846BMX2, NST847AMX2, NST847BMX2

Features

- Moisture Sensitivity Level: 1
- ESD Rating – Human Body Model: > 4000 V
– Machine Model: > 350 V
- These Devices are Pb-Free, Halogen Free/BFR Free and are RoHS Compliant

MAXIMUM RATINGS

Rating		Symbol	Value	Unit
Collector-Emitter Voltage	NST846 NST847	V_{CEO}	65 45	Vdc
Collector-Base Voltage	NST846 NST847	V_{CBO}	80 50	Vdc
Emitter-Base Voltage	NST846 NST847	V_{EBO}	6.0 6.0	Vdc
Collector Current – Continuous		I_C	100	mAdc

Stresses exceeding those listed in the Maximum Ratings table may damage the device. If any of these limits are exceeded, device functionality should not be assumed, damage may occur and reliability may be affected.

THERMAL CHARACTERISTICS

Characteristic	Symbol	Max	Unit
Total Power Dissipation (Note 1) @ $T_A = 25^\circ\text{C}$ Derate above 25°C	P_D	165 1.39	mW mW/ $^\circ\text{C}$
Thermal Resistance, Junction-to-Ambient (Note 1)	$R_{\theta JA}$	720	$^\circ\text{C}/\text{W}$
Total Power Dissipation (Note 2) @ $T_A = 25^\circ\text{C}$ Derate above 25°C	P_D	590 4.93	mW mW/ $^\circ\text{C}$
Thermal Resistance, Junction-to-Ambient (Note 2)	$R_{\theta JA}$	203	$^\circ\text{C}/\text{W}$
Junction and Storage Temperature Range	T_J, T_{stg}	-55 to +150	$^\circ\text{C}$

- Surface-mounted on FR4 board using a 0.6 mm^2 , 2 oz. Cu pad
- Surface-mounted on FR4 board using a 100 mm^2 , 2 oz. Cu pad

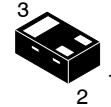
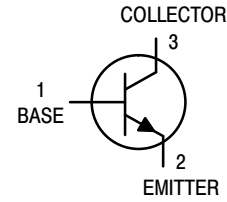

X2DFN3 (1.0x0.6)
CASE 714AC

MARKING DIAGRAM

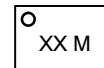

XX = Specific Device Code
M = Date Code

ORDERING INFORMATION

See detailed ordering and shipping information in the package dimensions section on page 11 of this data sheet.

NST846BMX2, NST847AMX2, NST847BMX2

ELECTRICAL CHARACTERISTICS ($T_A = 25^\circ\text{C}$ unless otherwise noted)

Characteristic	Symbol	Min	Typ	Max	Unit
OFF CHARACTERISTICS					
Collector – Emitter Breakdown Voltage ($I_C = 10\text{ mA}$)	NST846B NST847A, B	$V_{(BR)CEO}$	65 45	- -	V
Collector – Emitter Breakdown Voltage ($I_C = 10\ \mu\text{A}$, $V_{EB} = 0$)	NST846B NST847A, B	$V_{(BR)CES}$	80 50	- -	V
Collector – Base Breakdown Voltage ($I_C = 10\ \mu\text{A}$)	NST846B NST847A, B	$V_{(BR)CBO}$	80 50	- -	V
Emitter – Base Breakdown Voltage ($I_E = 1.0\ \mu\text{A}$)	NST846B NST847A/B	$V_{(BR)EBO}$	6.0 6.0	- -	V
Collector Cutoff Current ($V_{CB} = 30\text{ V}$) ($V_{CB} = 30\text{ V}$, $T_A = 150^\circ\text{C}$)		I_{CBO}	- -	- -	15 5.0 nA μA

ON CHARACTERISTICS

DC Current Gain ($I_C = 100\ \mu\text{A}$, $V_{CE} = 1.0\text{ V}$) ($I_C = 2.0\text{ mA}$, $V_{CE} = 5.0\text{ V}$)	NST847A NST846B, NST847B NST847A NST846B, NST847B	h_{FE}	- -	160 270	- -	-
Collector – Emitter Saturation Voltage ($I_C = 10\text{ mA}$, $I_B = 0.5\text{ mA}$) ($I_C = 100\text{ mA}$, $I_B = 5.0\text{ mA}$)		$V_{CE(sat)}$	- -	- -	0.25 0.6	V
Base – Emitter Saturation Voltage ($I_C = 10\text{ mA}$, $I_B = 0.5\text{ mA}$) ($I_C = 100\text{ mA}$, $I_B = 5.0\text{ mA}$)		$V_{BE(sat)}$	- -	0.7 0.9	-	V
Base – Emitter Voltage ($I_C = 2.0\text{ mA}$, $V_{CE} = 5.0\text{ V}$) ($I_C = 10\text{ mA}$, $V_{CE} = 5.0\text{ V}$)		$V_{BE(on)}$	580 -	660 -	700 770	mV

SMALL-SIGNAL CHARACTERISTICS

Current – Gain – Bandwidth Product ($I_C = 10\text{ mA}$, $V_{CE} = 5.0\text{ Vdc}$, $f = 100\text{ MHz}$)		f_T	100	-	-	MHz
Output Capacitance ($V_{CB} = 10\text{ V}$, $f = 1.0\text{ MHz}$)		C_{obo}	-	-	4.5	pF
Noise Figure ($I_C = 0.2\text{ mA}$, $V_{CE} = 5.0\text{ Vdc}$, $R_S = 2.0\text{ k}\Omega$, $f = 1.0\text{ kHz}$, $BW = 200\text{ Hz}$)	NST847A NST846B, NST847B	NF	- -	- -	10 4.0	dB

Product parametric performance is indicated in the Electrical Characteristics for the listed test conditions, unless otherwise noted. Product performance may not be indicated by the Electrical Characteristics if operated under different conditions.

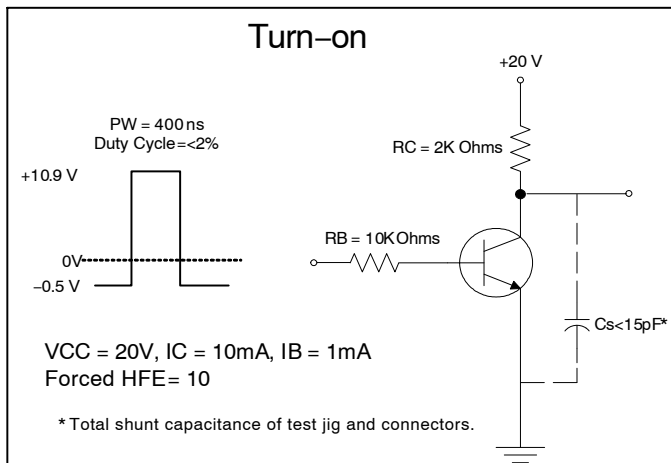

Figure 1. Delay and Rise Time Equivalent Test Circuit

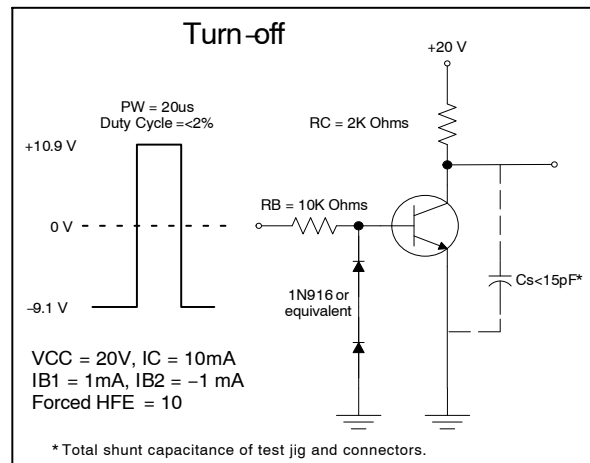

Figure 2. Storage and Fall Time Equivalent Test Circuit

TYPICAL CHARACTERISTICS – NST846BMX2

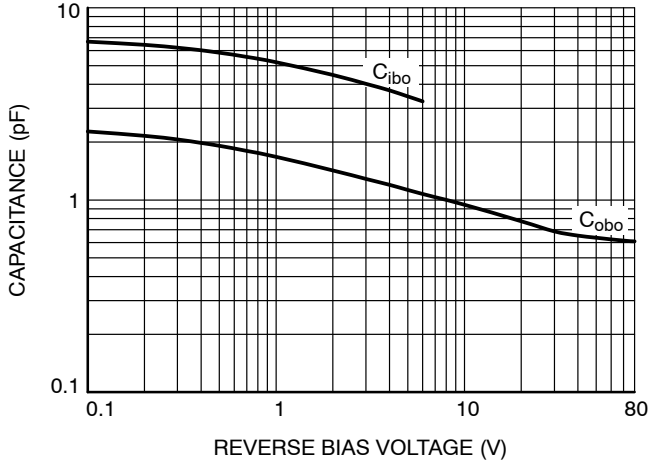

Figure 3. Capacitance

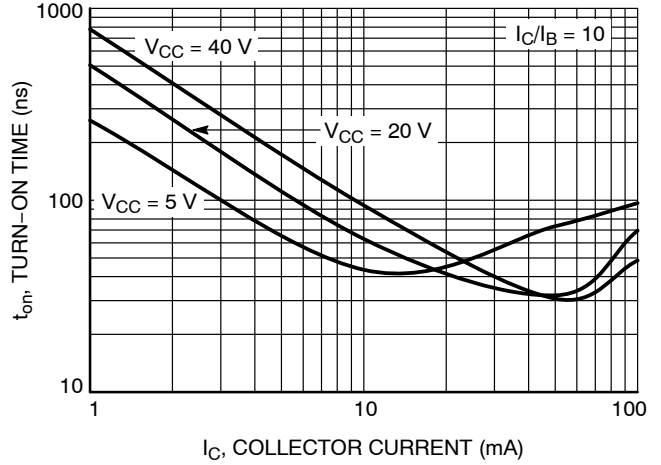

Figure 4. Turn-On Time

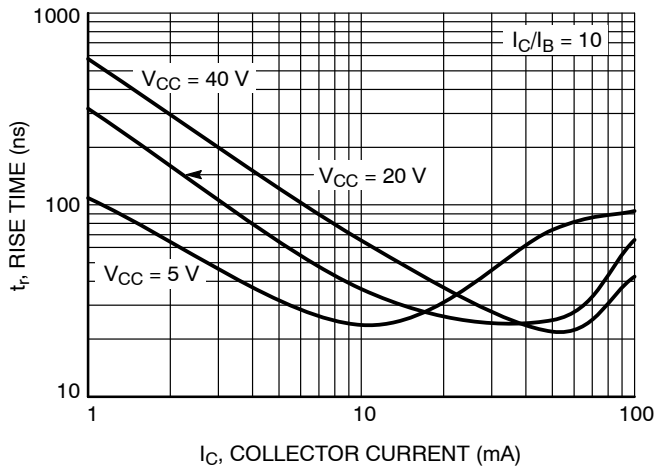

Figure 5. Rise Time

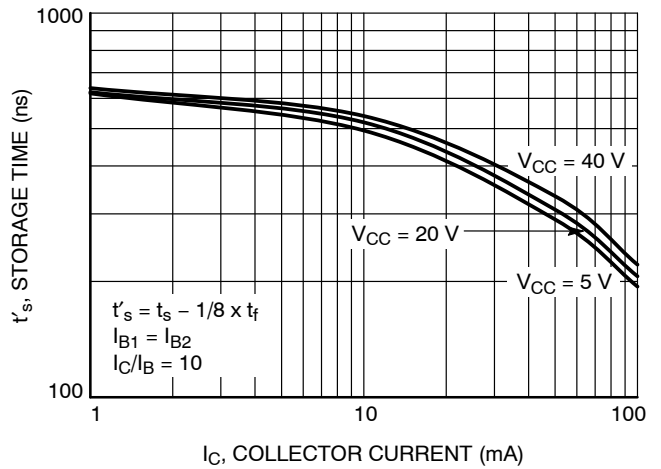

Figure 6. Storage Time

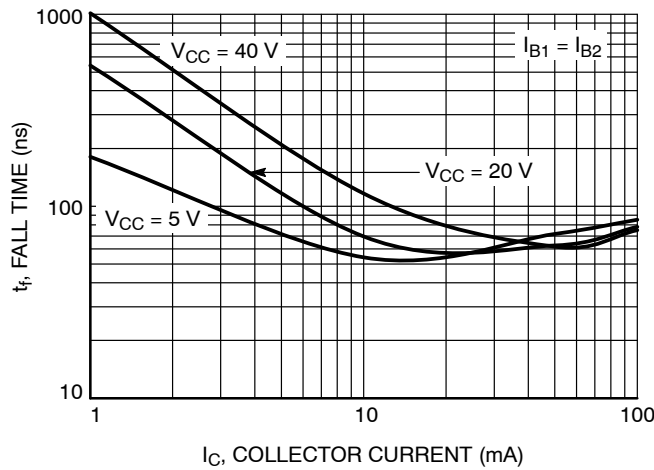

Figure 7. Fall Time

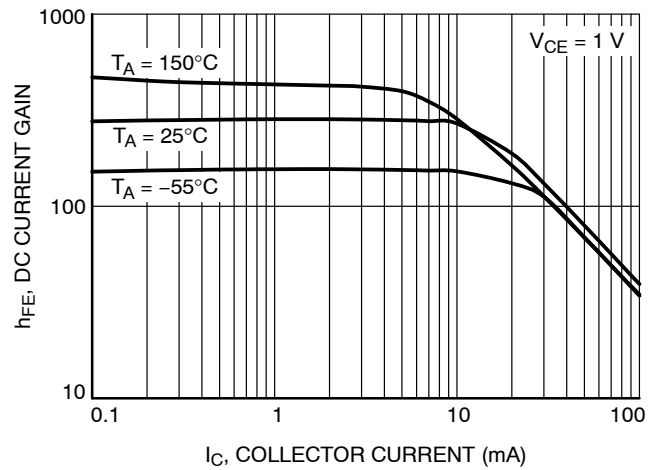

Figure 8. DC Current Gain

TYPICAL CHARACTERISTICS – NST846BMX2

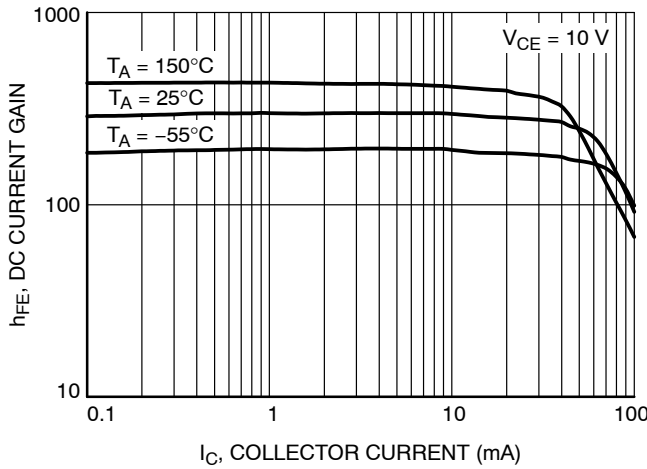

Figure 9. DC Current Gain

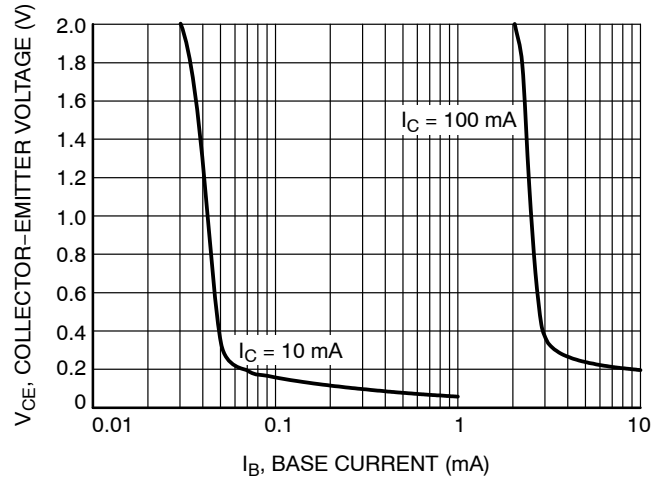

Figure 10. Collector Saturation Region

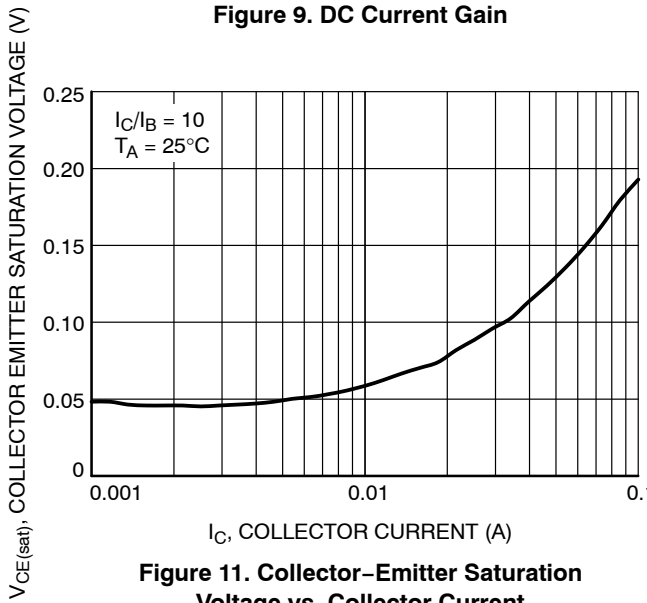

Figure 11. Collector-Emitter Saturation Voltage vs. Collector Current

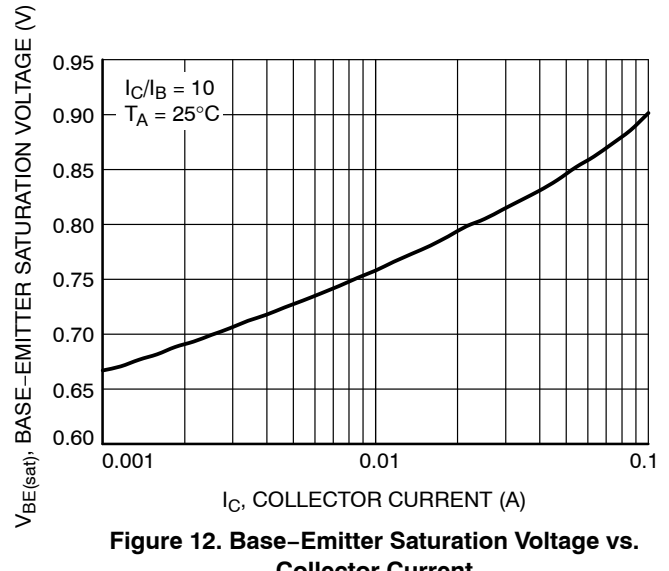

Figure 12. Base-Emitter Saturation Voltage vs. Collector Current

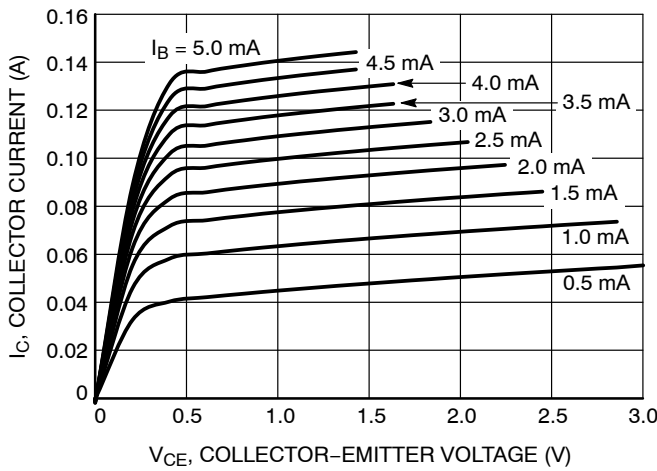

Figure 13. Collector Current vs. Collector-Emitter Voltage

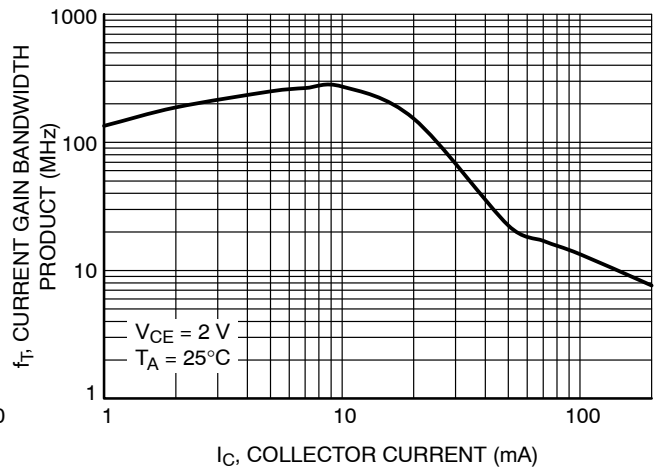

Figure 14. Current Gain Bandwidth vs. Collector Current

TYPICAL CHARACTERISTICS – NST846BMX2

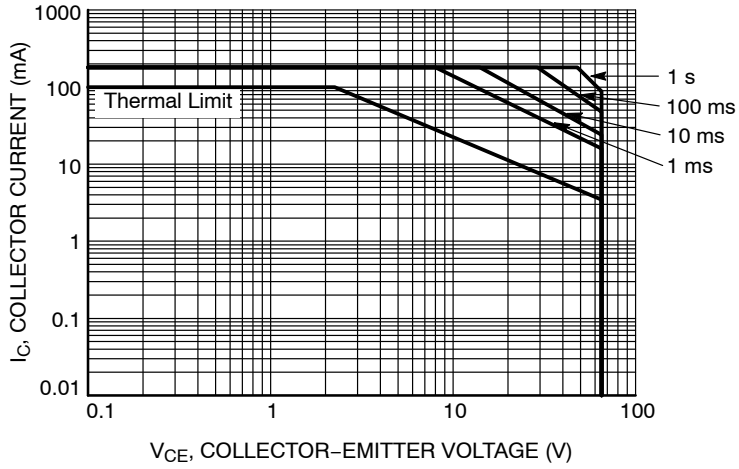

Figure 15. Safe Operating Area

TYPICAL CHARACTERISTICS – NST847AMX2

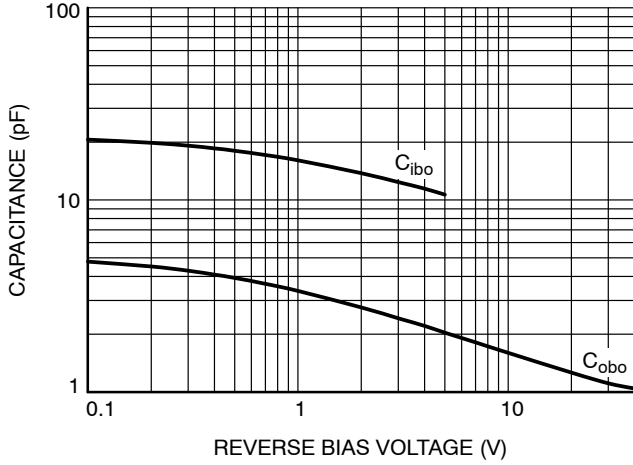

Figure 16. Capacitance

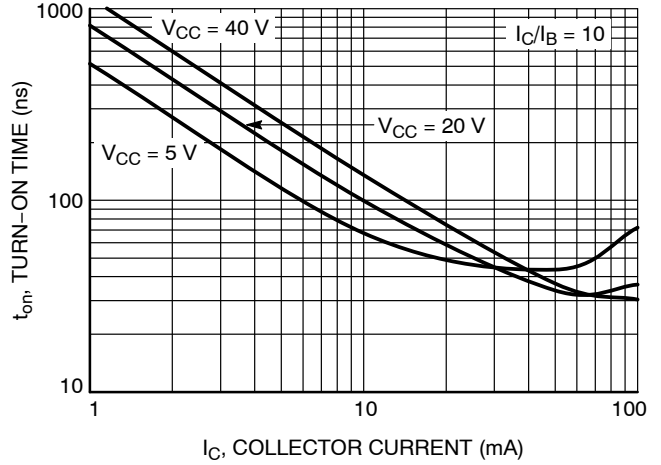

Figure 17. Turn-On Time

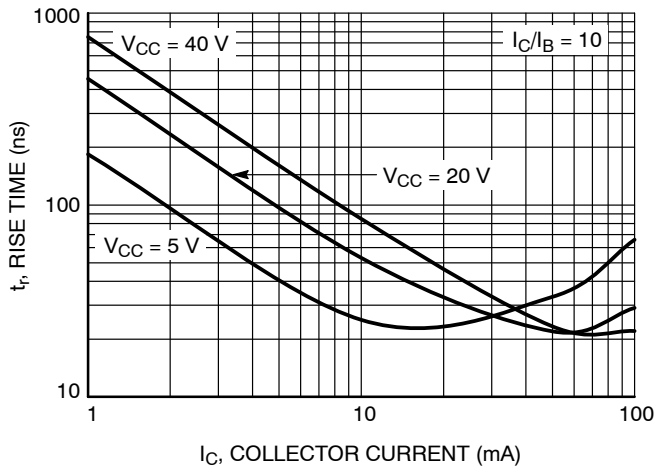

Figure 18. Rise Time

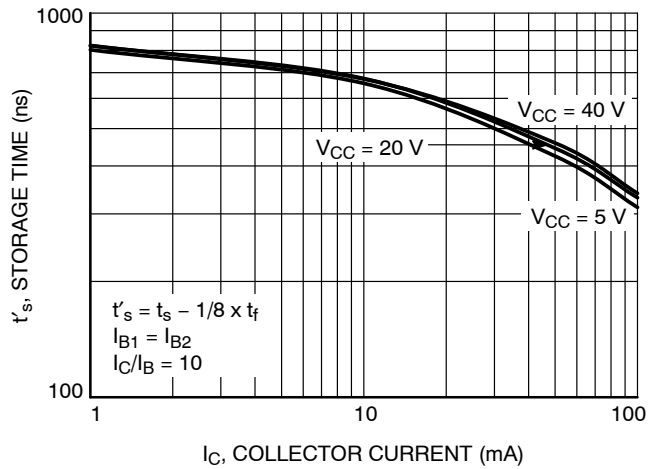

Figure 19. Storage Time

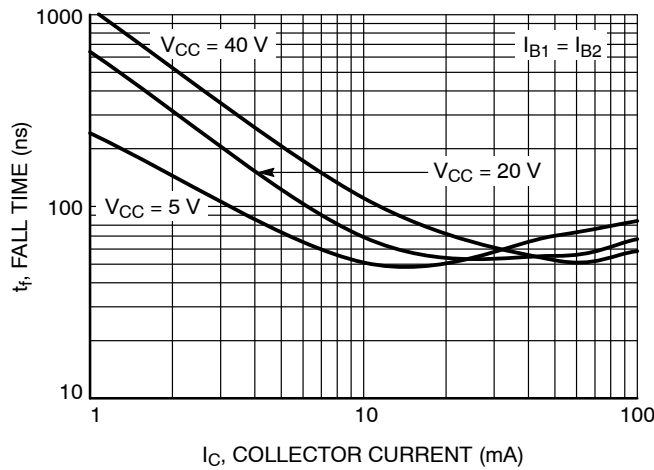

Figure 20. Fall Time

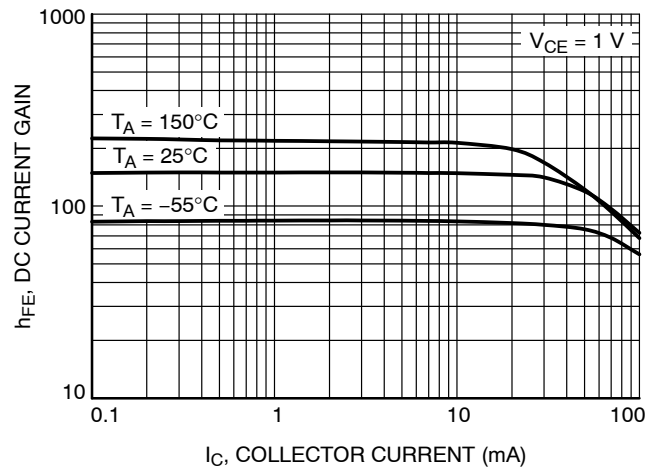

Figure 21. DC Current Gain

TYPICAL CHARACTERISTICS – NST847AMX2

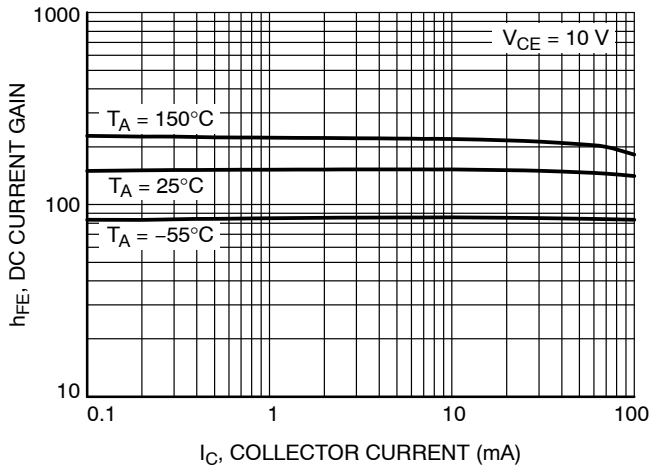

Figure 22. DC Current Gain

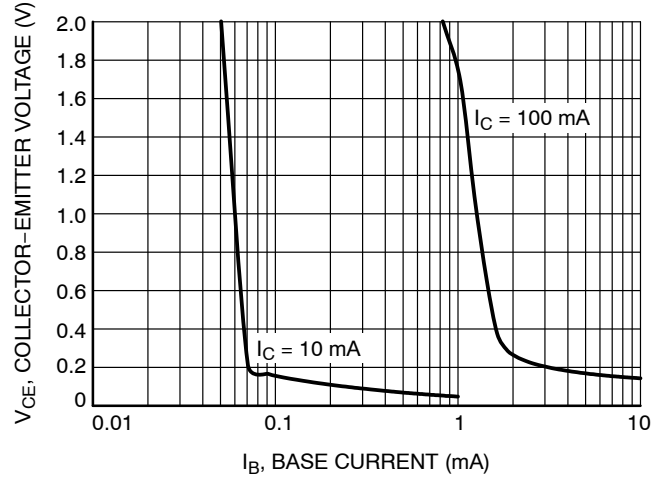

Figure 23. Collector Saturation Region

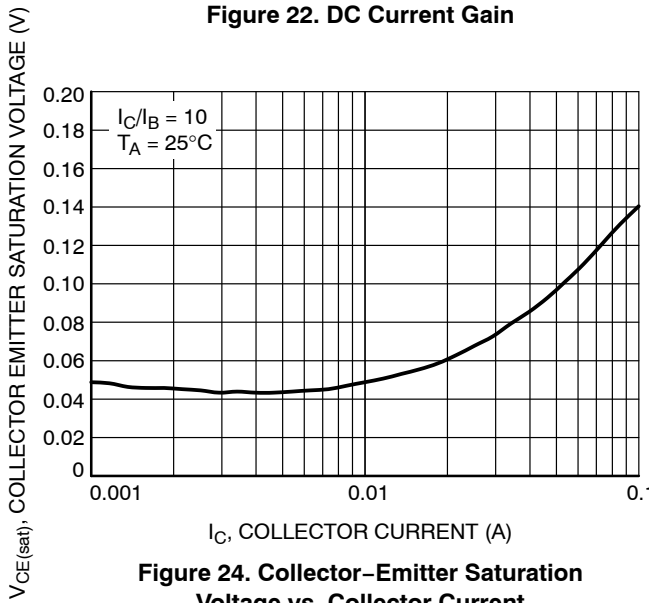

Figure 24. Collector-Emitter Saturation Voltage vs. Collector Current

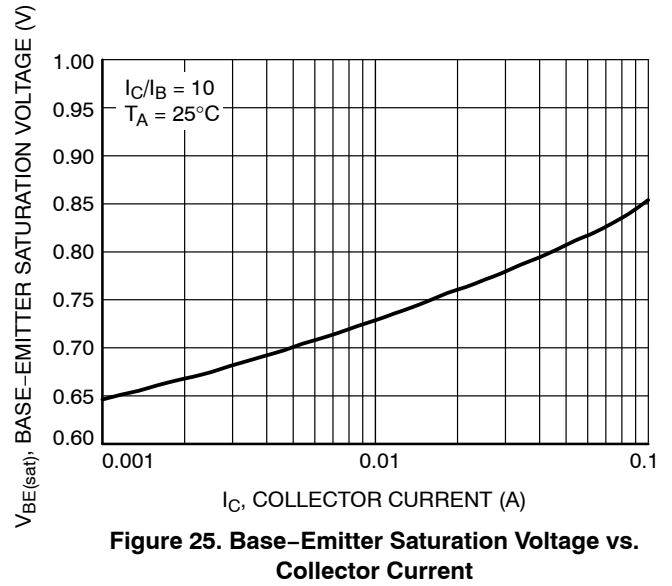

Figure 25. Base-Emitter Saturation Voltage vs. Collector Current

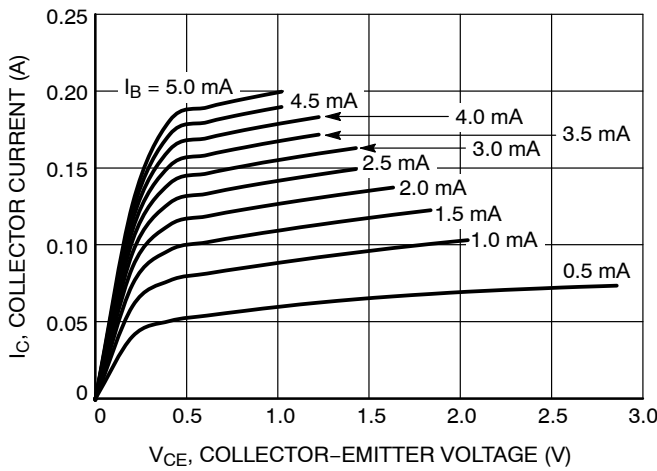

Figure 26. Collector Current vs. Collector-Emitter Voltage

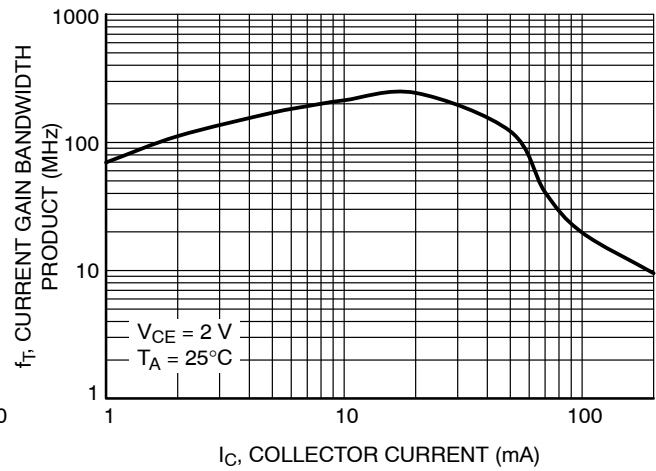

Figure 27. Current Gain Bandwidth vs. Collector Current

TYPICAL CHARACTERISTICS – NST847AMX2

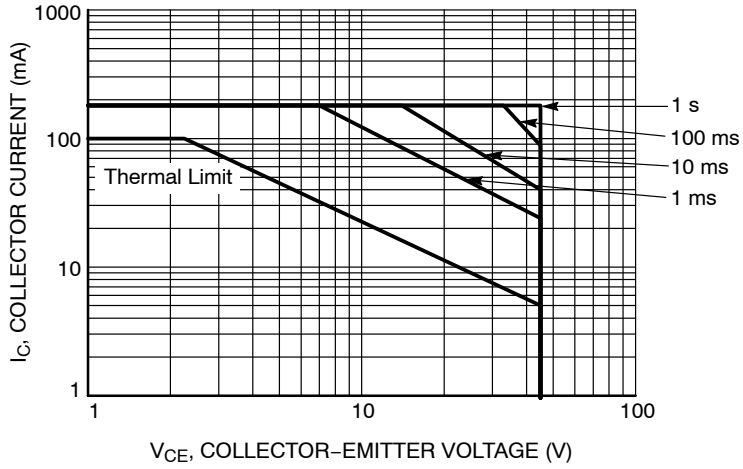

Figure 28. Safe Operating Area

TYPICAL CHARACTERISTICS – NST847BMX2

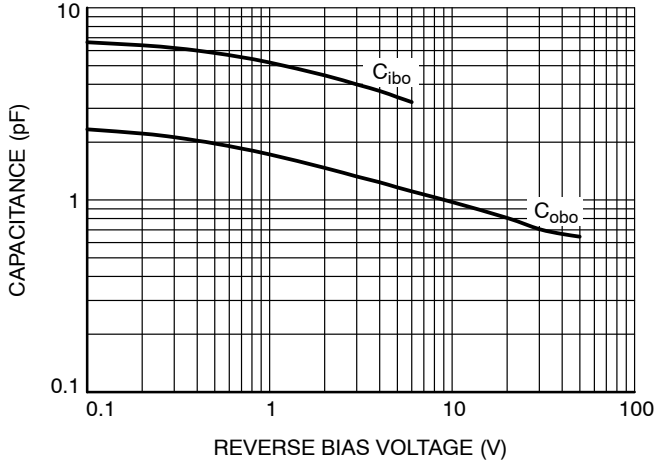

Figure 29. Capacitance

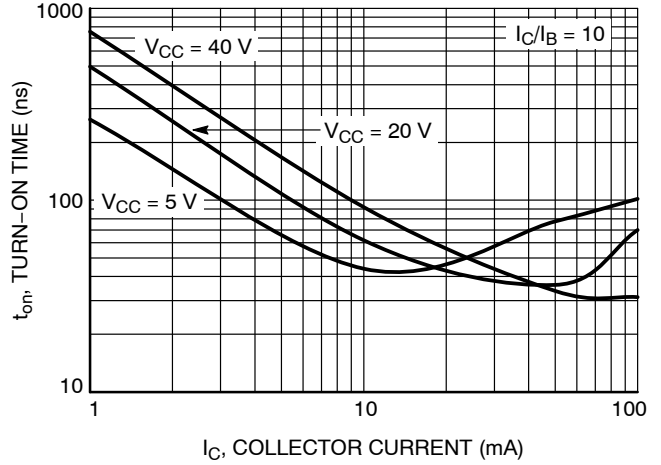

Figure 30. Turn-On Time

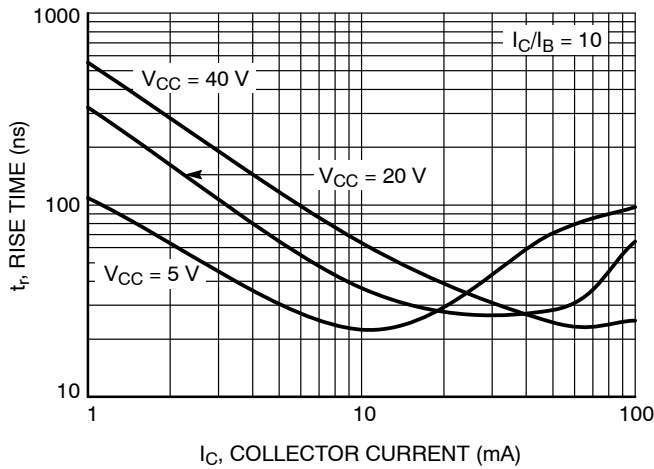

Figure 31. Rise Time

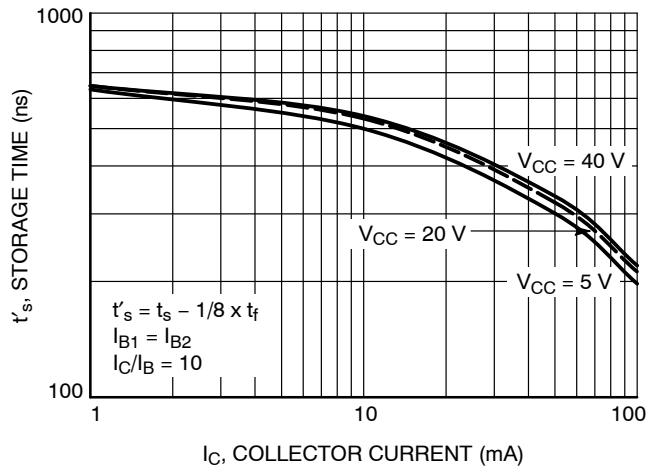

Figure 32. Storage Time

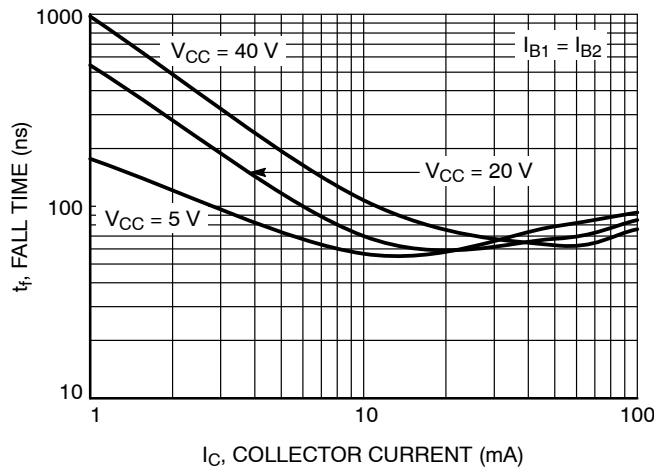

Figure 33. Fall Time

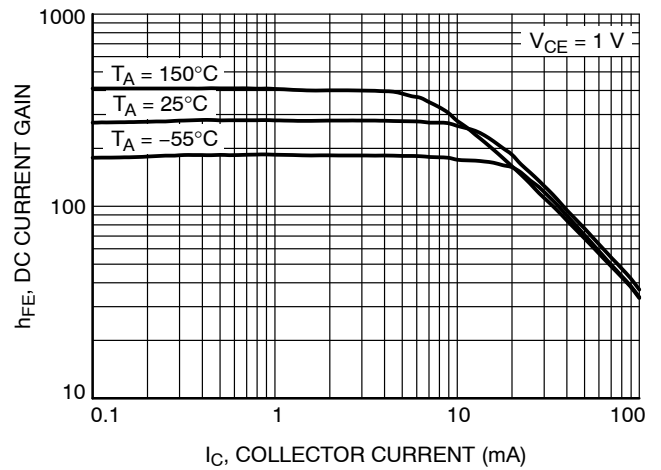

Figure 34. DC Current Gain

TYPICAL CHARACTERISTICS – NST847BMX2

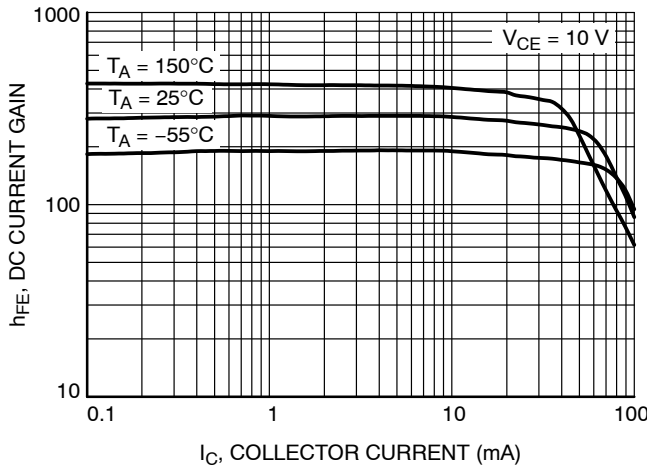

Figure 35. DC Current Gain

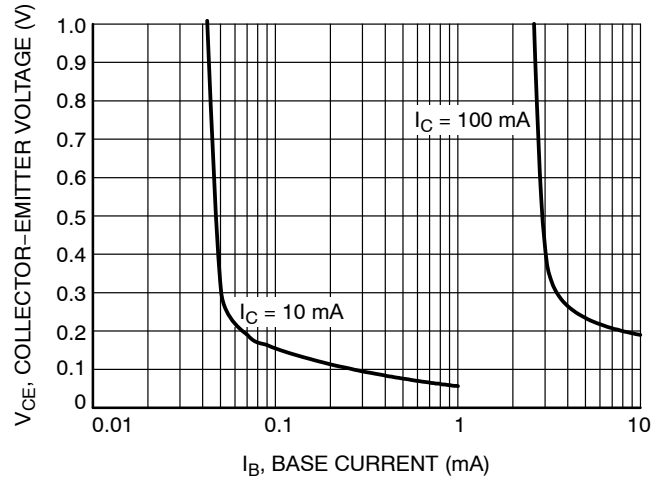

Figure 36. Collector Saturation Region

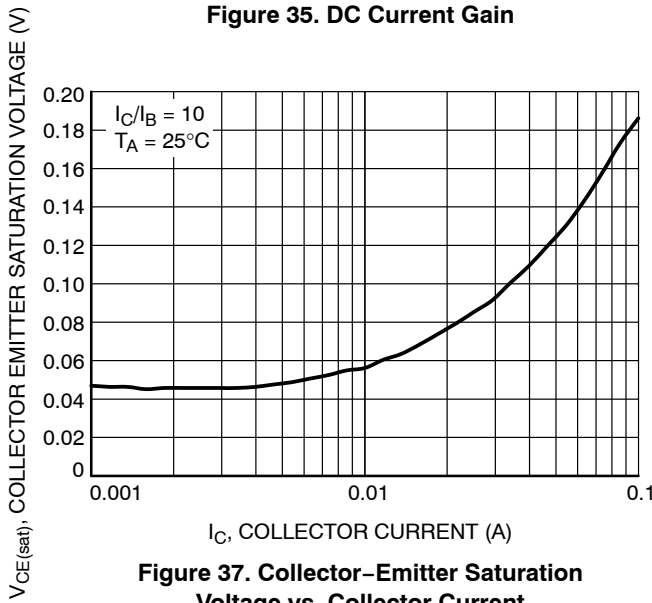

Figure 37. Collector-Emitter Saturation Voltage vs. Collector Current

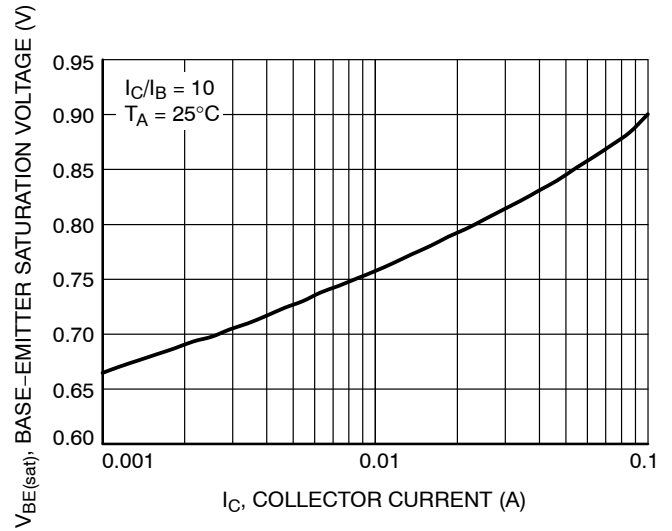

Figure 38. Base-Emitter Saturation Voltage vs. Collector Current

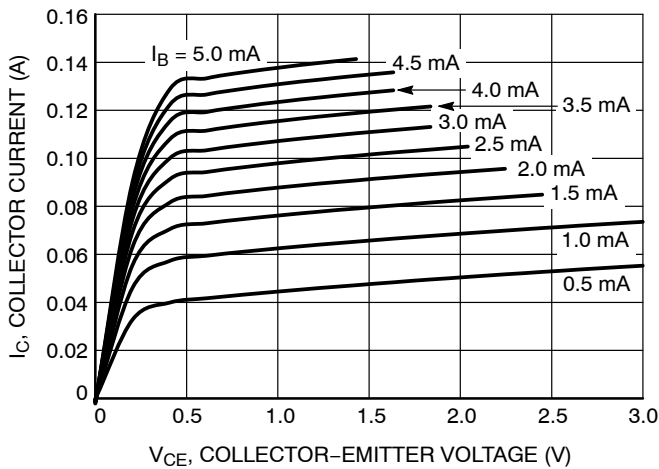

Figure 39. Collector Current vs. Collector-Emitter Voltage

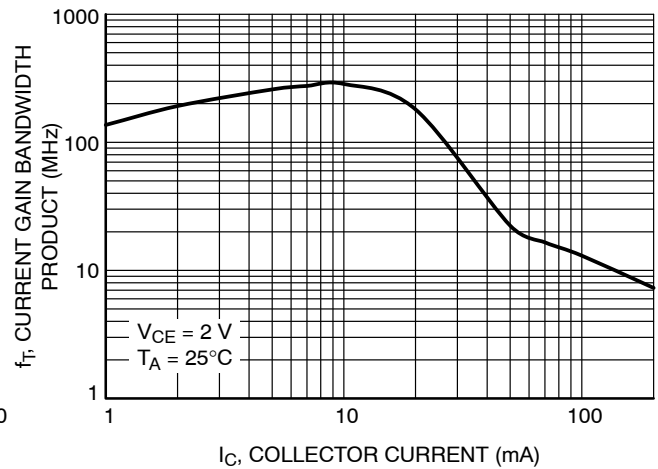

Figure 40. Current Gain Bandwidth vs. Collector Current

NST846BMX2, NST847AMX2, NST847BMX2

TYPICAL CHARACTERISTICS – NST847BMX2

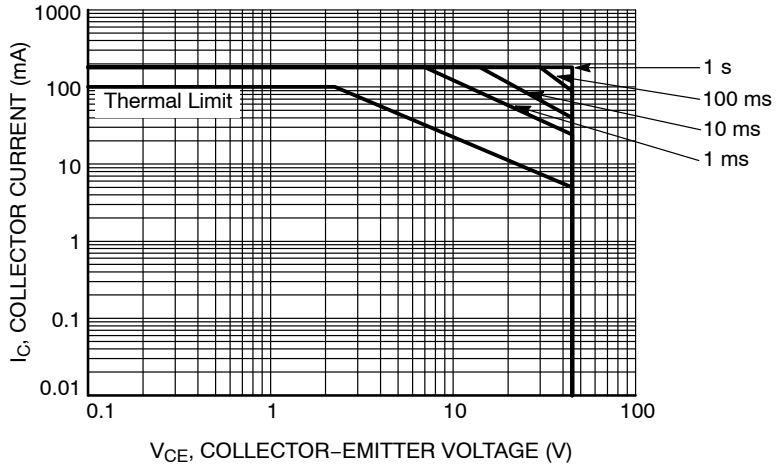

Figure 41. Safe Operating Area

ORDERING INFORMATION

Device	Marking	Package	Shipping†
NST846BMX2T5G	AD	X2DFN3 (1.0x0.6)	8,000 / Tape & Reel
NST847AMX2T5G	AA		
NST847BMX2T5G	AE		

†For information on tape and reel specifications, including part orientation and tape sizes, please refer to our Tape and Reel Packaging Specifications Brochure, BRD8011/D.

NST846BMX2, NST847AMX2, NST847BMX2

PACKAGE DIMENSIONS

X2DFN3 1.0x0.6, 0.35P
CASE 714AC
ISSUE A

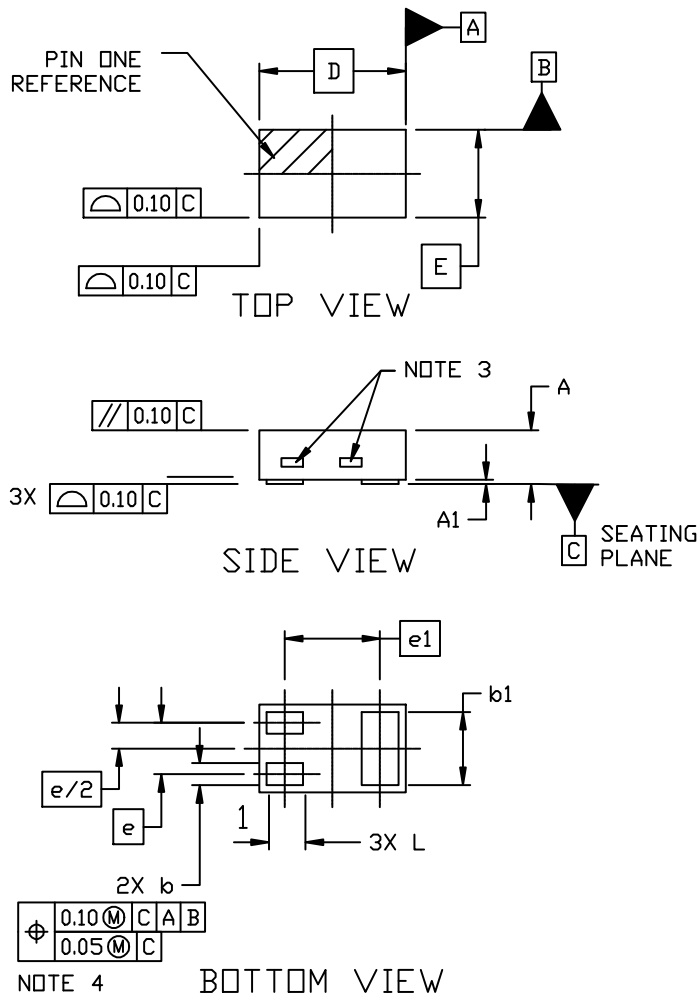

NOTES:

1. DIMENSIONING AND TOLERANCING PER ASME Y14.5M, 1994.
2. CONTROLLING DIMENSION: MILLIMETERS
3. EXPOSED COPPER ALLOWED AS SHOWN.
4. ALL PAD LOCATIONS CONTROLLED WITH THIS POSITIONAL TOLERANCE.

DIM	MILLIMETERS		
	MIN.	MAX.	MAX.
A	0.34	0.37	0.40
A1	0.00	---	0.05
b	0.10	0.15	0.20
b1	0.45	0.50	0.55
D	0.95	1.00	1.05
E	0.55	0.60	0.65
e	0.35 BSC		
e1	0.65 BSC		
L	0.20	0.25	0.30

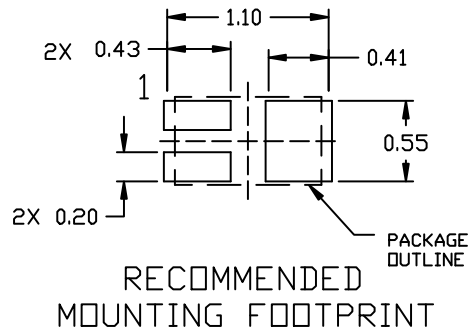

onsemi, Onsemi, and other names, marks, and brands are registered and/or common law trademarks of Semiconductor Components Industries, LLC dba "onsemi" or its affiliates and/or subsidiaries in the United States and/or other countries. onsemi owns the rights to a number of patents, trademarks, copyrights, trade secrets, and other intellectual property. A listing of onsemi's product/patent coverage may be accessed at www.onsemi.com/site/pdf/Patent-Marking.pdf. onsemi reserves the right to make changes at any time to any products or information herein, without notice. The information herein is provided "as-is" and onsemi makes no warranty, representation or guarantee regarding the accuracy of the information, product features, availability, functionality, or suitability of its products for any particular purpose, nor does onsemi assume any liability arising out of the application or use of any product or circuit, and specifically disclaims any and all liability, including without limitation special, consequential or incidental damages. Buyer is responsible for its products and applications using onsemi products, including compliance with all laws, regulations and safety requirements or standards, regardless of any support or applications information provided by onsemi. "Typical" parameters which may be provided in onsemi data sheets and/or specifications can and do vary in different applications and actual performance may vary over time. All operating parameters, including "Typicals" must be validated for each customer application by customer's technical experts. onsemi does not convey any license under any of its intellectual property rights nor the rights of others. onsemi products are not designed, intended, or authorized for use as a critical component in life support systems or any FDA Class 3 medical devices or medical devices with a same or similar classification in a foreign jurisdiction or any devices intended for implantation in the human body. Should Buyer purchase or use onsemi products for any such unintended or unauthorized application, Buyer shall indemnify and hold onsemi and its officers, employees, subsidiaries, affiliates, and distributors harmless against all claims, costs, damages, and expenses, and reasonable attorney fees arising out of, directly or indirectly, any claim of personal injury or death associated with such unintended or unauthorized use, even if such claim alleges that onsemi was negligent regarding the design or manufacture of the part. onsemi is an Equal Opportunity/Affirmative Action Employer. This literature is subject to all applicable copyright laws and is not for resale in any manner.

PUBLICATION ORDERING INFORMATION

LITERATURE FULFILLMENT:
Email Requests to: orderlit@onsemi.com

onsemi Website: www.onsemi.com

TECHNICAL SUPPORT
North American Technical Support:
Voice Mail: 1 800-282-9855 Toll Free USA/Canada
Phone: 011 421 33 790 2910

Europe, Middle East and Africa Technical Support:
Phone: 00421 33 790 2910
For additional information, please contact your local Sales Representative