

## Industry First Low Capacitance ESD Protection Arrays with Backdrive Protection

### Product Description

The CM1223 family of diode arrays has been designed to provide ESD protection for electronic components or subsystems requiring minimal capacitive loading. These devices are ideal for protecting systems with high data and clock rates or for circuits requiring low capacitive loading. Each ESD channel consists of a pair of diodes in series, which steer the positive or negative ESD current pulse to either the positive ( $V_P$ ) or negative ( $V_N$ ) supply rail. A Zener diode is embedded between  $V_P$  and  $V_N$ , to absorb positive ESD strikes and provide ESD protection for the  $V_P$  rail. An additional diode is integrated to serve as backdrive current protection. The CM1223 protects against ESD pulses up to  $\pm 8$  kV per the IEC 61000-4-2 standard. In addition, all pins are protected from contact discharges of greater than  $\pm 15$  kV as outlined by the MIL-STD-883D (Method 3015) specification for Human Body Model (HBM) ESD.

These devices are particularly well-suited for protecting systems using high-speed ports such as USB2.0, IEEE1394 (Firewire<sup>®</sup>, iLink<sup>™</sup>), serial ATA, DVI, HDMI and corresponding ports in removable storage, digital camcorders, DVD-RW drives, as well as other applications where extremely low loading capacitance with ESD protection are required in a small package footprint.

### Features

- Two, Four, and Eight Channels of ESD Protection with Integrated Backdrive Protection on all Lines
- Provides ESD Protection to IEC61000-4-2 Level 4:  $\pm 8$  kV Contact Discharge &  $\pm 15$  kV Air Discharge
- Low Channel Input Capacitance of 1.0 pF (typical)
- Minimal Capacitance Change with Temperature and Voltage
- Channel I/O to GND Capacitance Difference of 0.02 pF Typical is Ideal for Differential Signals
- Mutual Capacitance between Signal Pin and Adjacent Signal Pin at 0.11 pF (typical)
- Zener Diode Protects Supply Rail and Eliminates the Need for External Bypass Capacitors
- Pin Compatible with CM1213-02, -04, and -08
- Each I/O Pin Can Withstand over 1000 ESD Strikes
- Available in SOT, and MSOP Packages
- These Devices are Pb-Free and are RoHS Compliant

### Applications

- USB 2.0 Ports at 480 Mbps in Desktop PCs, Notebooks and Peripherals
- IEEE1394 Firewire<sup>®</sup> Ports at 400 Mbps / 800 Mbps
- DVI Ports, HDMI Ports in Notebooks, Set Top Boxes, Digital TVs, LCD Displays



ON Semiconductor<sup>®</sup>

<http://onsemi.com>



SOT23-5  
SO SUFFIX  
CASE 527AH



SOT23-6  
SO SUFFIX  
CASE 527AJ

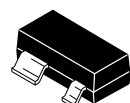

SOT-143  
SR SUFFIX  
CASE 318A

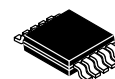

MSOP 10  
MR SUFFIX  
CASE 846AE

### BLOCK DIAGRAM

(see page 2)

### MARKING DIAGRAM

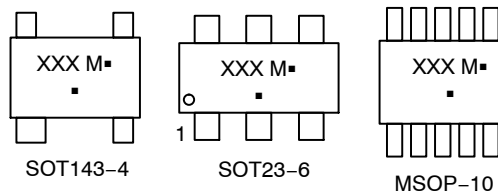

XXX = Specific Device Code  
M = Date Code  
▪ = Pb-Free Package  
(Note: Microdot may be in either location)

### ORDERING INFORMATION

| Device      | Package            | Shipping         |
|-------------|--------------------|------------------|
| CM1223-02SO | SOT23-5 (Pb-Free)  | 3000/Tape & Reel |
| CM1223-02SR | SOT143-4 (Pb-Free) | 3000/Tape & Reel |
| CM1223-04SO | SOT23-6 (Pb-Free)  | 3000/Tape & Reel |
| CM1223-04MR | MSOP-10 (Pb-Free)  | 4000/Tape & Reel |
| CM1223-08MR | MSOP-10 (Pb-Free)  | 4000/Tape & Reel |

†For information on tape and reel specifications, including part orientation and tape sizes, please refer to our Tape and Reel Packaging Specification Brochure, BRD8011/D.

- UDI and Display Ports
- Serial ATA Ports in Desktop PCs and Hard Disk Drives
- PCI Express Ports
- General Purpose High-speed Data Line ESD Protection

# CM1223

## BLOCK DIAGRAM

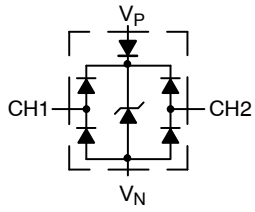

CM1223-02SO  
CM1223-02SR

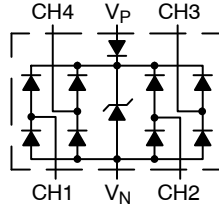

CM1223-04SO  
CM1223-04MR

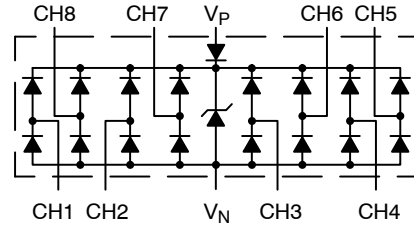

CM1223-08MR

Table 1. PIN DESCRIPTIONS

| 2-Channel, 5-Lead SOT23-5 Package |                |      |                              |
|-----------------------------------|----------------|------|------------------------------|
| Pin                               | Name           | Type | Description                  |
| 1                                 | NC             |      | No Connect                   |
| 2                                 | V <sub>N</sub> | GND  | Negative voltage supply rail |
| 3                                 | CH1            | I/O  | ESD Channel                  |
| 4                                 | CH2            | I/O  | ESD Channel                  |
| 5                                 | V <sub>P</sub> | PWR  | Positive voltage supply rail |

| 2-Channel, 4-Lead SOT143-4 Package |                |      |                              |
|------------------------------------|----------------|------|------------------------------|
| Pin                                | Name           | Type | Description                  |
| 1                                  | V <sub>N</sub> | GND  | Negative voltage supply rail |
| 2                                  | CH1            | I/O  | ESD Channel                  |
| 3                                  | CH2            | I/O  | ESD Channel                  |
| 4                                  | V <sub>P</sub> | PWR  | Positive voltage supply rail |

| 4-Channel, 6-Lead SOT23-6 Package |                |      |                              |
|-----------------------------------|----------------|------|------------------------------|
| Pin                               | Name           | Type | Description                  |
| 1                                 | CH1            | I/O  | ESD Channel                  |
| 2                                 | V <sub>N</sub> | GND  | Negative voltage supply rail |
| 3                                 | CH2            | I/O  | ESD Channel                  |
| 4                                 | CH3            | I/O  | ESD Channel                  |
| 5                                 | V <sub>P</sub> | PWR  | Positive voltage supply rail |
| 6                                 | CH4            | I/O  | ESD Channel                  |

| 4-Channel, 10-Lead MSOP-10 Package |                |      |                              |
|------------------------------------|----------------|------|------------------------------|
| Pin                                | Name           | Type | Description                  |
| 1                                  | CH1            | I/O  | ESD Channel                  |
| 2                                  | NC             |      | No Connect                   |
| 3                                  | V <sub>P</sub> | PWR  | Positive voltage supply rail |
| 4                                  | CH2            | I/O  | ESD Channel                  |
| 5                                  | NC             |      | No Connect                   |
| 6                                  | CH3            | I/O  | ESD Channel                  |
| 7                                  | NC             |      | No Connect                   |
| 8                                  | V <sub>N</sub> | GND  | Negative voltage supply rail |
| 9                                  | CH4            | I/O  | ESD Channel                  |
| 10                                 | NC             |      | No Connect                   |

| 8-Channel, 10-Lead MSOP-10 Package |                |      |                              |
|------------------------------------|----------------|------|------------------------------|
| Pin                                | Name           | Type | Description                  |
| 1                                  | CH1            | I/O  | ESD Channel                  |
| 2                                  | CH2            | I/O  | ESD Channel                  |
| 3                                  | CH3            | I/O  | ESD Channel                  |
| 4                                  | CH4            | I/O  | ESD Channel                  |
| 5                                  | V <sub>N</sub> | GND  | Negative voltage supply rail |
| 6                                  | CH5            | I/O  | ESD Channel                  |
| 7                                  | CH6            | I/O  | ESD Channel                  |
| 8                                  | V <sub>P</sub> | PWR  | Positive voltage supply rail |
| 9                                  | CH7            | I/O  | ESD Channel                  |
| 10                                 | CH8            | I/O  | ESD Channel                  |

PACKAGE / PINOUT DIAGRAMS

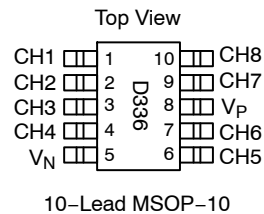
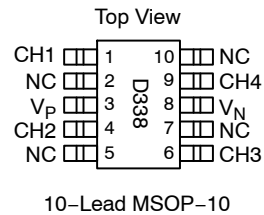
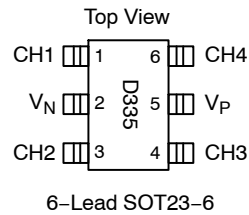
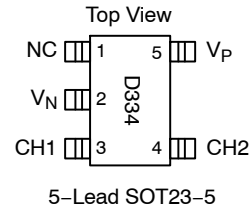
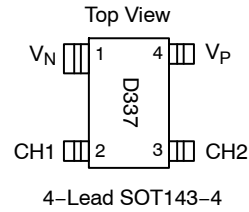

# CM1223

## SPECIFICATIONS

**Table 2. ABSOLUTE MAXIMUM RATINGS**

| Parameter                                | Rating                         | Units |
|--|--------------------------------|-------|
| Operating Supply Voltage ( $V_P - V_N$ ) | 6.0                            | V     |
| Operating Temperature Range              | -40 to +85                     | °C    |
| Storage Temperature Range                | -65 to +150                    | °C    |
| DC Voltage at any channel input          | $(V_N - 0.5)$ to $(V_P + 0.5)$ | V     |

Stresses exceeding Maximum Ratings may damage the device. Maximum Ratings are stress ratings only. Functional operation above the Recommended Operating Conditions is not implied. Extended exposure to stresses above the Recommended Operating Conditions may affect device reliability.

**Table 3. STANDARD OPERATING CONDITIONS**

| Parameter  | Rating                          | Units |
|--|---------------------------------|-------|
| Operating Temperature Range  | -40 to +85                      | °C    |
| Package Power Rating<br>SOT143-4 Package (CM1223-02SR)<br>SOT23-5 Package (CM1223-02SO)<br>SOT23-6 Package (CM1223-04SO)<br>MSOP-10 Package (CM1223-04MR)<br>MSOP-10 Package (CM1223-08MR) | 225<br>225<br>225<br>400<br>400 | mW    |

**Table 4. ELECTRICAL OPERATING CHARACTERISTICS (Note1)**

| Symbol          | Parameter   | Conditions   | Min         | Typ          | Max  | Units |
|-----------------|---|--|-------------|--------------|------|-------|
| $V_P$           | Operating Supply Voltage ( $V_P - V_N$ )  |  |             | 3.3          | 5.5  | V     |
| $I_P$           | Operating Supply Current  | $(V_P - V_N) = 3.3$ V  |             |              | 8.0  | μA    |
| $V_{SCL}$       | Signal Clamp Voltage<br>Positive Transients<br>Negative Transients  | $I_F = 8$ mA; $T_A = 25^\circ\text{C}$   | 6.7<br>0.60 | 8.2<br>0.80  |      | V     |
| $I_{LEAK}$      | Channel Leakage Current   | $T_A = 25^\circ\text{C}$ ; $V_P = 5$ V, $V_N = 0$ V  |             | ±0.1         | ±1.0 | μA    |
| $C_{IN}$        | Channel Input Capacitance   | At 1 MHz, $V_P = 3.3$ V, $V_N = 0$ V, $V_{IN} = 1.65$ V                                      |             | 1.0          | 1.5  | pF    |
| $\Delta C_{IN}$ | Channel Input Capacitance Matching  | At 1 MHz, $V_P = 3.3$ V, $V_N = 0$ V, $V_{IN} = 1.65$ V                                      |             | 0.02         |      | pF    |
| $C_{MUTUAL}$    | Mutual Capacitance between signal pin and adjacent signal pin   | At 1 MHz, $V_P = 3.3$ V, $V_N = 0$ V, $V_{IN} = 1.65$ V                                      |             | 0.11         |      | pF    |
| $V_{ESD}$       | ESD Protection – Peak Discharge Voltage at any channel input, in system<br>a) Contact discharge per IEC 61000-4-2 standard<br>b) Human Body Model, MIL-STD-883, Method 3015 | $T_A = 25^\circ\text{C}$ ; (Notes 3 and 4)<br>$T_A = 25^\circ\text{C}$ ; (Notes 2 and 4)     |             | ±8<br>±15    |      | kV    |
| $V_{CL}$        | Channel Clamp Voltage<br>Positive Transients<br>Negative Transients   | $T_A = 25^\circ\text{C}$ , $I_{PP} = 1$ A, $t_P = 8/20$ μS (Note 4)                          |             | +8.8<br>-1.4 |      | V     |
| $R_{DYN}$       | Dynamic Resistance<br>Positive Transients<br>Negative Transients  | $T_A = 25^\circ\text{C}$ , $I_{PP} = 1$ A, $t_P = 8/20$ μS<br>Any I/O pin to Ground (Note 4) |             | 0.7<br>0.4   |      | Ω     |

- All parameters specified at  $T_A = -40^\circ\text{C}$  to  $+85^\circ\text{C}$  unless otherwise noted.
- Human Body Model per MIL-STD-883, Method 3015,  $C_{Discharge} = 100$  pF,  $R_{Discharge} = 1.5$  kΩ,  $V_P = 3.3$  V,  $V_N$  grounded.
- Standard IEC 61000-4-2 with  $C_{Discharge} = 150$  pF,  $R_{Discharge} = 330$  Ω,  $V_P = 3.3$  V,  $V_N$  grounded.
- These measurements performed with no external capacitor on  $V_P$  ( $V_P$  floating).

PERFORMANCE INFORMATION

Input Channel Capacitance Performance Curves

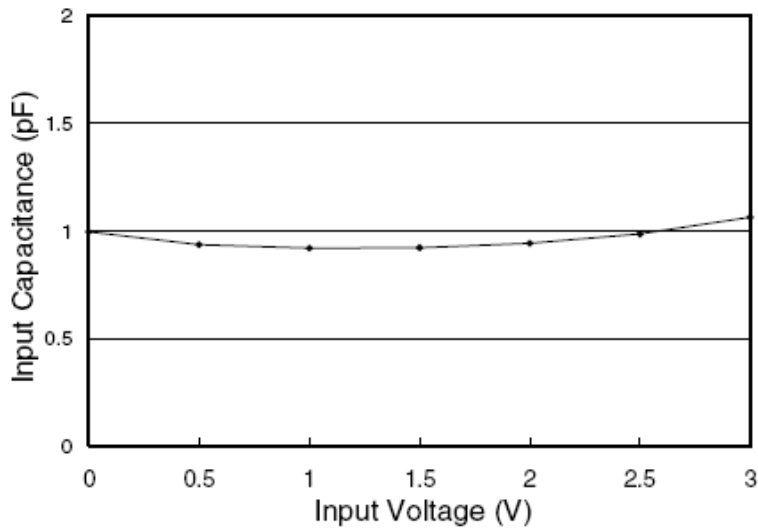

Typical Variation of  $C_{IN}$  vs.  $V_{IN}$

( $f=1\text{MHz}$ ,  $V_P = 3.3\text{V}$ ,  $V_N = 0\text{V}$ ,  $0.1 \mu\text{F}$  chip capacitor between  $V_P$  and  $V_N$ ,  $25^\circ\text{C}$ )

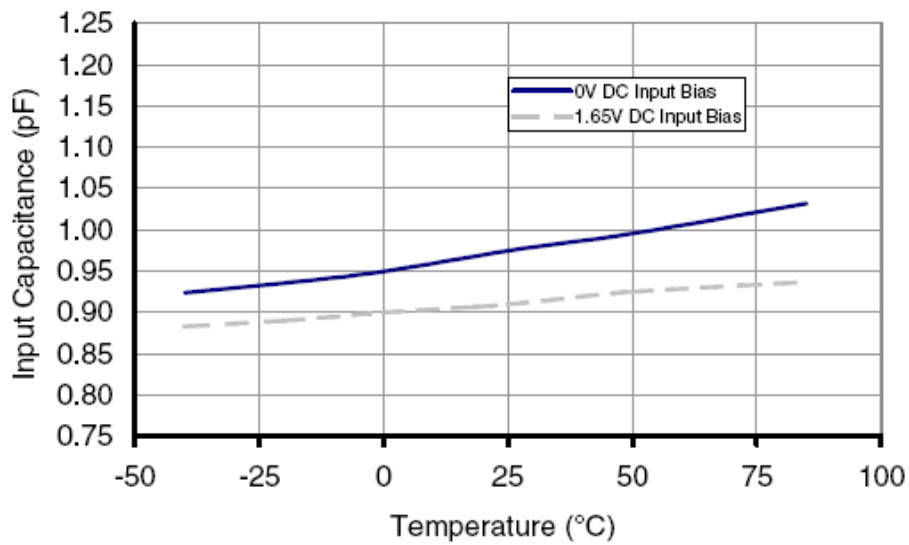

Typical Variation of  $C_{IN}$  vs. Temp

( $f=1\text{MHz}$ ,  $V_{IN}=30\text{mV}$ ,  $V_P = 3.3\text{V}$ ,  $V_N = 0\text{V}$ ,  $0.1 \mu\text{F}$  chip capacitor between  $V_P$  and  $V_N$ )

# CM1223

## PERFORMANCE INFORMATION (Cont'd)

Typical Filter Performance (nominal conditions unless specified otherwise, 50 Ohm Environment)

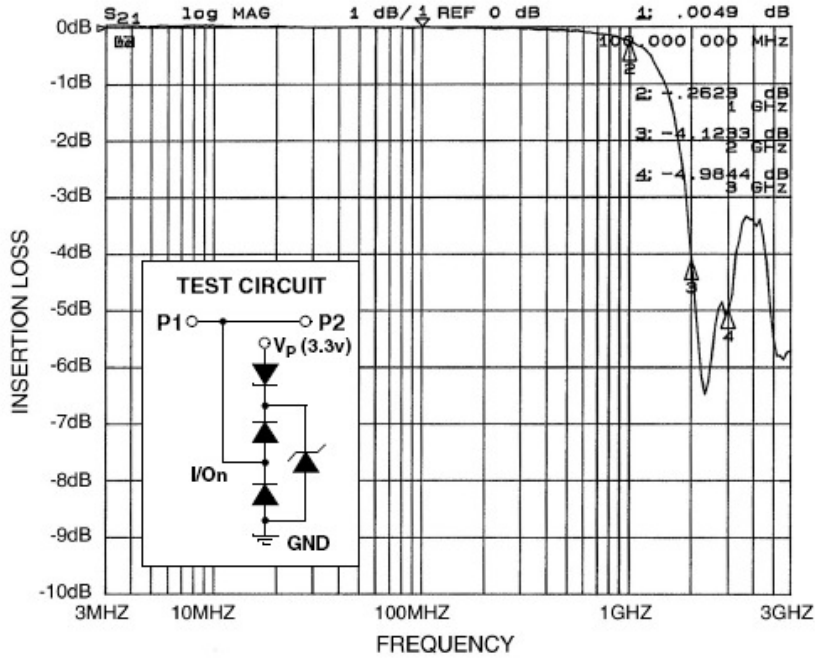

Figure 1. Insertion Loss (S<sub>21</sub>) vs. Frequency (0 V DC Bias, V<sub>p</sub>=3.3 V, MSOP-10 Package)

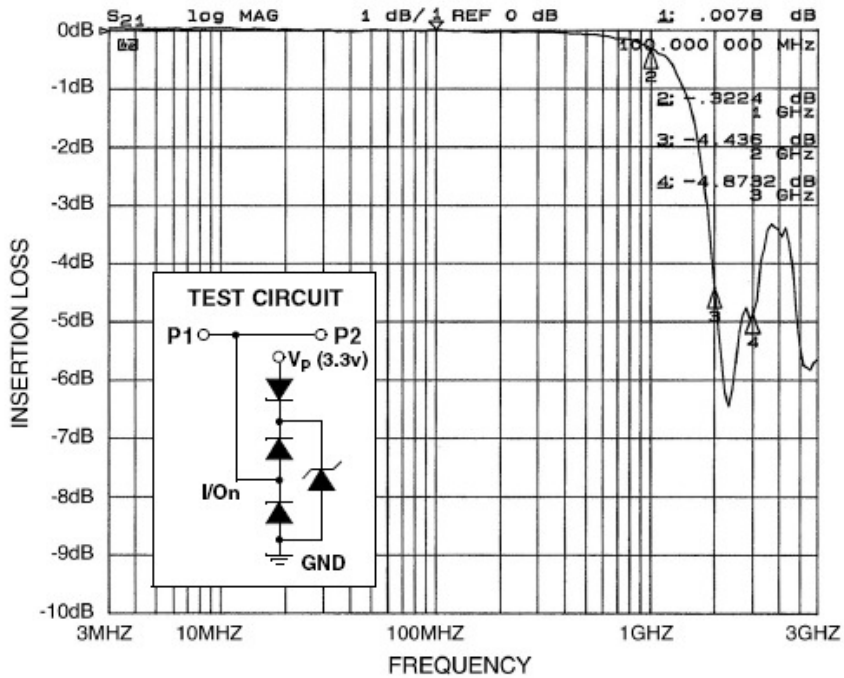

Figure 2. Insertion Loss (S<sub>21</sub>) vs. Frequency (2.5 V DC Bias, V<sub>p</sub>=3.3 V, MSOP-10 Package)

## BACKDRIVE PROTECTION

Backdrive protection is needed to block against backdrive current flowing from a high potential voltage node toward a lower potential voltage node through the interface cable.

For example, consider a DVD player connected to a TV via an HDMI interface. If the DVD player is switched off and the TV is left on, there is a possibility of reverse current flow back into the main power supply rail of the DVD player. Typically, the DVD's power supply has some form of associated bulk supply capacitance, and it is possible over time to charge that bulk supply capacitance to some intermediate level.

If that level rises above the power-on-reset (POR) voltage level of some of the integrated circuits, the DVD player may not reset properly when the DVD player is turned back on. This is largely because all CMOS logic exhibits a very high impedance on the power rail node even when "off".

To avoid this situation, the CM1223 with integrated backdrive protection diode was designed to block backdrive current, guaranteeing no more than 5  $\mu\text{A}$  on any I/O pin when the I/O pin voltage is greater than the CM1223 supply voltage.

## APPLICATION INFORMATION

### Design Considerations

To realize the maximum protection against ESD pulses, care must be taken in the PCB layout to minimize parasitic series inductances on the Supply/Ground rails as well as the signal trace segments between the signal input (typically a connector) and the ESD protection device. Application of Positive ESD Pulse between Input Channel and Ground illustrates an example of a positive 8 kV ESD pulse striking an input channel. The 8 kV ESD current pulse will divert along the path as indicated in Application of Positive ESD Pulse between Input Channel and Ground, through the D1 diode and the Zener diode back to the ground rail.

An ESD current pulse can rise from zero to its peak value in a very short time. For example, a level 4 contact discharge per the IEC61000-4-2 standard results in a current pulse that rises from zero to 30 Amps in 1ns. The CM1223 has a fast response time of less than 1ns and low clamp voltage to handle this pulse scenario.

Similarly for negative ESD pulses, parasitic series inductance from the  $V_N$  pin to the ground rail will lead to drastically increased negative voltage on the line being protected.

The CM1223 also has an integrated backdrive diode between  $V_P$  and  $V_N$  to prevent backdrive current flow from the powered sources.

As a general rule, the ESD Protection Array should be located as close as possible to the point of entry of expected electrostatic discharges.

ADDITIONAL INFORMATION

See also ON Semiconductor Application Note “Design Considerations for ESD Protection”, in the Applications section.

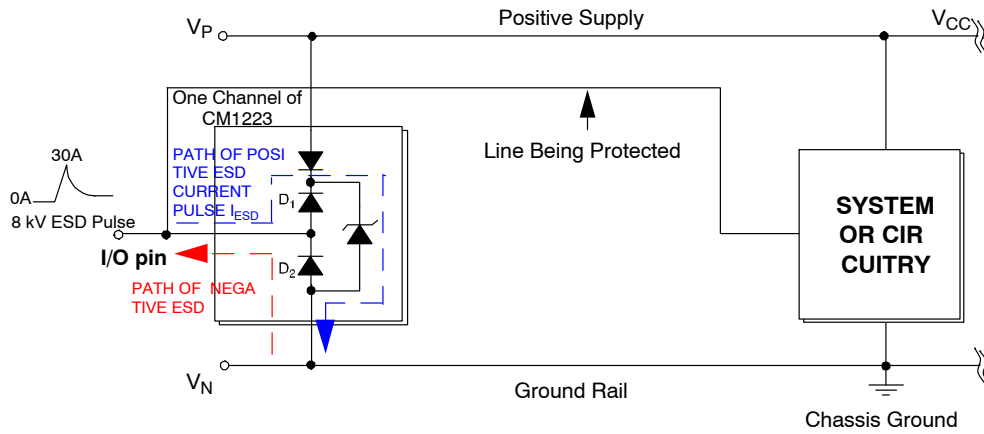

Figure 3. Application of Positive ESD Pulse between Input Channel and Ground

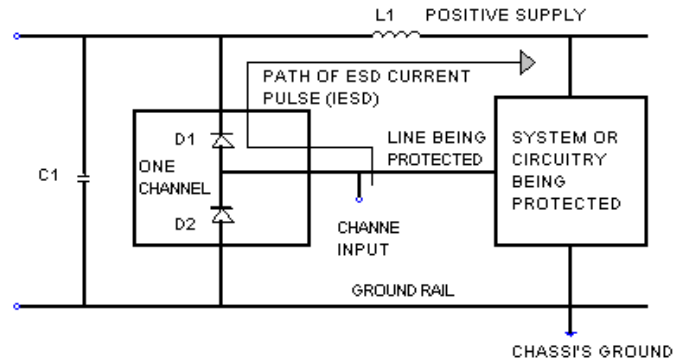

Figure 4. Application of Positive ESD Pulse between Input Channel and Ground



# CM1223

## MECHANICAL DETAILS

The CM1223 is available in SOT143-4, SOT23-5, SOT23-6, and MSOP-10 packages with a lead-free finishing. The various package drawings are presented below.

### SOT143 Mechanical Specifications

The CM1223-02SR is supplied in 4-pin SOT143 package, the CM1223-02SO in a 5-pin SOT23 package, the CM1223-04SO in a 6-pin SOT23 package, and the CM1223-08MR in a 10-lead MSOP package. Dimensions are presented below.

**Table 5. TAPE AND REEL SPECIFICATIONS**

| Part Number | Chip Size (mm)     | Pocket Size (mm)<br>$B_0 \times A_0 \times K_0$ | Tape Width<br>W | Reel<br>Diameter | Qty per<br>Reel | $P_0$ | $P_1$ |
|-------------|--------------------|---|-----------------|------------------|-----------------|-------|-------|
| CM1223-02SR | 2.92 X 2.37 X 1.01 | 2.60 X 3.15 X 1.20                              | 8 mm            | 178 mm (7")      | 3000            | 4 mm  | 4 mm  |
| CM1223-02SO | 2.90 X 2.80 X 1.45 | 3.20 X 3.20 X 1.40                              | 8 mm            | 178 mm (7")      | 3000            | 4 mm  | 4 mm  |
| CM1223-04SO | 2.90 X 2.80 X 1.45 | 3.20 X 3.20 X 1.40                              | 8 mm            | 178 mm (7")      | 3000            | 4 mm  | 4 mm  |
| CM1223-08MR | 3.00 X 3.00 X 0.85 | 3.30 X 5.30 X 1.30                              | 12 mm           | 330 mm (13")     | 4000            | 4 mm  | 8 mm  |

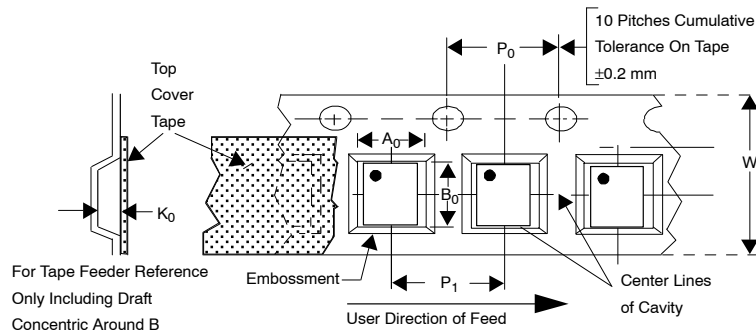

# MECHANICAL CASE OUTLINE PACKAGE DIMENSIONS

ON Semiconductor®

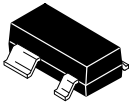

SCALE 4:1

## SOT-143 CASE 318A-06 ISSUE U

DATE 07 SEP 2011

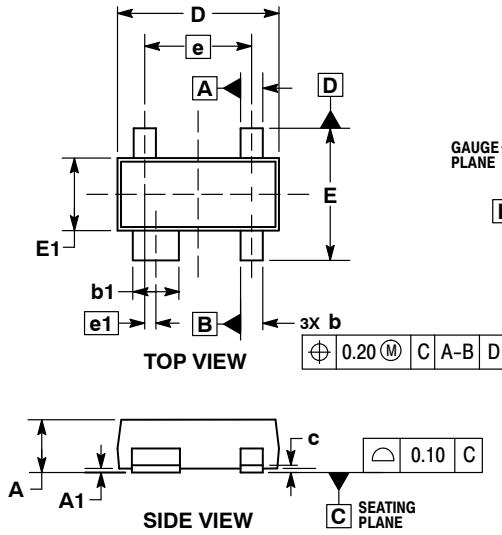

**NOTES:**

1. DIMENSIONING AND TOLERANCING PER ASME Y14.5M, 1994.
2. CONTROLLING DIMENSION: MILLIMETERS.
3. MAXIMUM LEAD THICKNESS INCLUDES LEAD FINISH. MINIMUM LEAD THICKNESS IS THE MINIMUM THICKNESS OF BASE MATERIAL.
4. DIMENSIONS D AND E DO NOT INCLUDE MOLD FLASH, PROTRUSIONS, OR GATE BURRS. MOLD FLASH, PROTRUSIONS, AND GATE BURRS SHALL NOT EXCEED 0.25 PER SIDE. DIMENSION E1 DOES NOT INCLUDE INTERLEAD FLASH OR PROTRUSION. INTERLEAD FLASH AND PROTRUSION SHALL NOT EXCEED 0.25 PER SIDE.
5. DIMENSIONS D AND E1 ARE DETERMINED AT DATUM H.
6. DATUMS A AND B ARE DETERMINED AT DATUM H.

| DIM | MILLIMETERS |      |
|-----|-------------|------|
|     | MIN         | MAX  |
| A   | 0.80        | 1.12 |
| A1  | 0.01        | 0.15 |
| b   | 0.30        | 0.51 |
| b1  | 0.76        | 0.94 |
| c   | 0.08        | 0.20 |
| D   | 2.80        | 3.05 |
| E   | 2.10        | 2.64 |
| E1  | 1.20        | 1.40 |
| e   | 1.92 BSC    |      |
| e1  | 0.20 BSC    |      |
| L   | 0.35        | 0.70 |
| L2  | 0.25 BSC    |      |

### RECOMMENDED SOLDERING FOOTPRINT

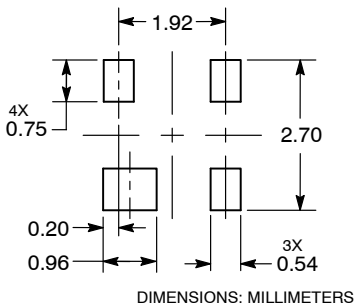

### GENERIC MARKING DIAGRAM\*

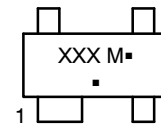

XXX = Specific Device Code

M = Date Code

■ = Pb-Free Package

(Note: Microdot may be in either location)

\*This information is generic. Please refer to device data sheet for actual part marking. Pb-Free indicator, "G" or microdot "■", may or may not be present.

**STYLE 1:**  
PIN 1. COLLECTOR  
2. EMITTER  
3. EMITTER  
4. BASE

**STYLE 2:**  
PIN 1. SOURCE  
2. DRAIN  
3. GATE 1  
4. GATE 2

**STYLE 3:**  
PIN 1. GROUND  
2. SOURCE  
3. INPUT  
4. OUTPUT

**STYLE 4:**  
PIN 1. OUTPUT  
2. GROUND  
3. GROUND  
4. INPUT

**STYLE 5:**  
PIN 1. SOURCE  
2. DRAIN  
3. GATE 1  
4. SOURCE

**STYLE 6:**  
PIN 1. GND  
2. RF IN  
3. VREG  
4. RF OUT

**STYLE 7:**  
PIN 1. SOURCE  
2. GATE  
3. DRAIN  
4. SOURCE

**STYLE 8:**  
PIN 1. SOURCE  
2. GATE  
3. DRAIN  
4. N/C

**STYLE 9:**  
PIN 1. GND  
2. IOUT  
3. VCC  
4. VREF

**STYLE 10:**  
PIN 1. DRAIN  
2. N/C  
3. SOURCE  
4. GATE

**STYLE 11:**  
PIN 1. SOURCE  
2. GATE 1  
3. GATE 2  
4. DRAIN

|                         |                    |  |
|-------------------------|--------------------|--|
| <b>DOCUMENT NUMBER:</b> | <b>98ASB42227B</b> | Electronic versions are uncontrolled except when accessed directly from the Document Repository. Printed versions are uncontrolled except when stamped "CONTROLLED COPY" in red. |
| <b>DESCRIPTION:</b>     | <b>SOT-143</b>     | <b>PAGE 1 OF 1</b>   |

ON Semiconductor and ON are trademarks of Semiconductor Components Industries, LLC dba ON Semiconductor or its subsidiaries in the United States and/or other countries. ON Semiconductor reserves the right to make changes without further notice to any products herein. ON Semiconductor makes no warranty, representation or guarantee regarding the suitability of its products for any particular purpose, nor does ON Semiconductor assume any liability arising out of the application or use of any product or circuit, and specifically disclaims any and all liability, including without limitation special, consequential or incidental damages. ON Semiconductor does not convey any license under its patent rights nor the rights of others.

# MECHANICAL CASE OUTLINE PACKAGE DIMENSIONS

ON Semiconductor®



## SOT-23, 5 Lead CASE 527AH ISSUE A

DATE 09 JUN 2021



NOTES:

1. DIMENSIONING AND TOLERANCING PER ASME Y14.5M, 1989A
2. CONTROLLING DIMENSION: MILLIMETERS
3. MAXIMUM LEAD THICKNESS INCLUDES LEAD FINISH THICKNESS. MINIMUM LEAD THICKNESS IS THE MINIMUM THICKNESS OF THE BASE MATERIAL.
4. DIMENSIONS D AND E1 DO NOT INCLUDE MOLD FLASH, PROTRUSIONS, OR GATE BURRS. MOLD FLASH, PROTRUSIONS, OR GATE BURRS SHALL NOT EXCEED 0.25 PER SIDE. D AND E1 DIMENSIONS ARE DETERMINED AT DATUM D.
5. DIMENSION 'b' DOES NOT INCLUDE DAMBAR PROTRUSION. ALLOWABLE DAMBAR PROTRUSION SHALL BE 0.08mm TOTAL IN EXCESS OF THE 'b' DIMENSION AT MAXIMUM MATERIAL CONDITION. MINIMUM SPACE BETWEEN PROTRUSION AND AN ADJACENT LEAD SHALL NOT BE LESS THAN 0.07mm.



| DIM    | MILLIMETERS |      |      |
|--------|-------------|------|------|
|        | MIN.        | NOM. | MAX. |
| A      | 0.90        | —    | 1.45 |
| A1     | 0.00        | —    | 0.15 |
| A2     | 0.90        | 1.15 | 1.30 |
| b      | 0.30        | —    | 0.50 |
| c      | 0.08        | —    | 0.22 |
| D      | 2.90 BSC    |      |      |
| E      | 2.80 BSC    |      |      |
| E1     | 1.60 BSC    |      |      |
| e      | 0.95 BSC    |      |      |
| L      | 0.30        | 0.45 | 0.60 |
| L1     | 0.60 REF    |      |      |
| L2     | 0.25 REF    |      |      |
| theta  | 0°          | 4°   | 8°   |
| theta1 | 0°          | 10°  | 15°  |
| theta2 | 0°          | 10°  | 15°  |

### GENERIC MARKING DIAGRAM\*



XXX = Specific Device Code  
M = Date Code

\*This information is generic. Please refer to device data sheet for actual part marking. Pb-Free indicator, "G" or microdot "•", may or may not be present. Some products may not follow the Generic Marking.



For additional information on our Pb-Free strategy and soldering details, please download the ON Semiconductor Soldering and Mounting Techniques Reference Manual, SOLDERRM/D.

|                  |                |  |
|------------------|----------------|--|
| DOCUMENT NUMBER: | 98AON34320E    | Electronic versions are uncontrolled except when accessed directly from the Document Repository. Printed versions are uncontrolled except when stamped "CONTROLLED COPY" in red. |
| DESCRIPTION:     | SOT-23, 5 LEAD | PAGE 1 OF 1  |

ON Semiconductor and ON are trademarks of Semiconductor Components Industries, LLC dba ON Semiconductor or its subsidiaries in the United States and/or other countries. ON Semiconductor reserves the right to make changes without further notice to any products herein. ON Semiconductor makes no warranty, representation or guarantee regarding the suitability of its products for any particular purpose, nor does ON Semiconductor assume any liability arising out of the application or use of any product or circuit, and specifically disclaims any and all liability, including without limitation special, consequential or incidental damages. ON Semiconductor does not convey any license under its patent rights nor the rights of others.

# MECHANICAL CASE OUTLINE

## PACKAGE DIMENSIONS

ON Semiconductor®



SOT-23, 6 Lead  
CASE 527AJ  
ISSUE B



SCALE 2:1

DATE 29 FEB 2012

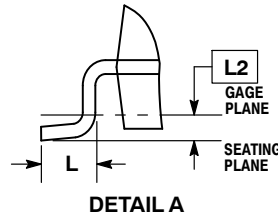
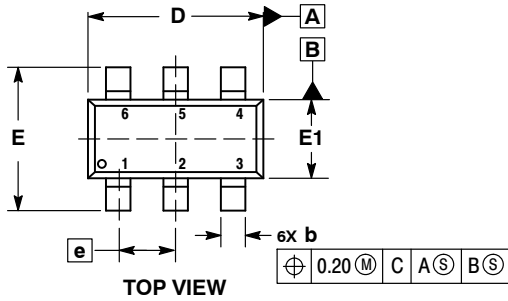

- NOTES:
1. DIMENSIONING AND TOLERANCING PER ASME Y14.5M, 1994.
  2. CONTROLLING DIMENSION: MILLIMETERS.
  3. DATUM C IS THE SEATING PLANE.

| MILLIMETERS |          |      |
|-------------|----------|------|
| DIM         | MIN      | MAX  |
| A           | ---      | 1.45 |
| A1          | 0.00     | 0.15 |
| A2          | 0.90     | 1.30 |
| b           | 0.20     | 0.50 |
| c           | 0.08     | 0.26 |
| D           | 2.70     | 3.00 |
| E           | 2.50     | 3.10 |
| E1          | 1.30     | 1.80 |
| e           | 0.95 BSC |      |
| L           | 0.20     | 0.60 |
| L2          | 0.25 BSC |      |

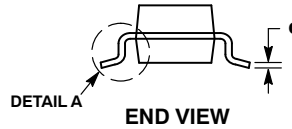
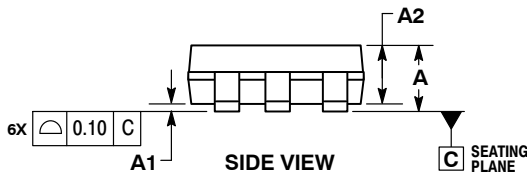

### GENERIC MARKING DIAGRAM\*

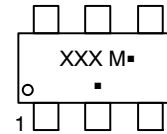

- XXX = Specific Device Code
- M = Date Code
- = Pb-Free Package

(Note: Microdot may be in either location)

\*This information is generic. Please refer to device data sheet for actual part marking. Pb-Free indicator, "G" or microdot "▪", may or may not be present.

### RECOMMENDED SOLDERING FOOTPRINT\*

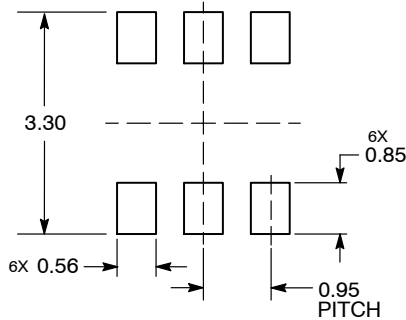

DIMENSIONS: MILLIMETERS

\*For additional information on our Pb-Free strategy and soldering details, please download the ON Semiconductor Soldering and Mounting Techniques Reference Manual, SOLDERRM/D.

|                  |                |  |
|------------------|----------------|--|
| DOCUMENT NUMBER: | 98AON34321E    | Electronic versions are uncontrolled except when accessed directly from the Document Repository. Printed versions are uncontrolled except when stamped "CONTROLLED COPY" in red. |
| DESCRIPTION:     | SOT-23, 6 LEAD | PAGE 1 OF 1  |

ON Semiconductor and are trademarks of Semiconductor Components Industries, LLC dba ON Semiconductor or its subsidiaries in the United States and/or other countries. ON Semiconductor reserves the right to make changes without further notice to any products herein. ON Semiconductor makes no warranty, representation or guarantee regarding the suitability of its products for any particular purpose, nor does ON Semiconductor assume any liability arising out of the application or use of any product or circuit, and specifically disclaims any and all liability, including without limitation special, consequential or incidental damages. ON Semiconductor does not convey any license under its patent rights nor the rights of others.

# MECHANICAL CASE OUTLINE

## PACKAGE DIMENSIONS

ON Semiconductor®



SCALE 1:1

MSOP10, 3x3  
CASE 846AE  
ISSUE A

DATE 20 JUN 2017

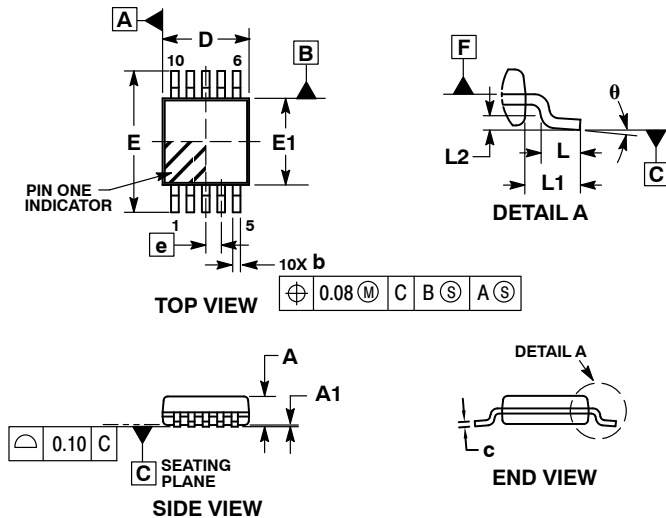

- NOTES:
1. DIMENSIONS AND TOLERANCING PER ASME Y14.5M, 1994.
  2. CONTROLLING DIMENSIONS: MILLIMETERS.
  3. DIMENSION b DOES NOT INCLUDE DAMBAR PROTRUSION. ALLOWABLE DAMBAR PROTRUSION SHALL BE 0.10 MM IN EXCESS OF MAXIMUM MATERIAL CONDITION.
  4. DIMENSION D DOES NOT INCLUDE MOLD FLASH, PROTRUSIONS, OR GATE BURRS. MOLD FLASH, PROTRUSIONS, OR GATE BURRS SHALL NOT EXCEED 0.15 MM PER SIDE. DIMENSION E DOES NOT INCLUDE INTERLEAD FLASH OR PROTRUSION. INTERLEAD FLASH OR PROTRUSION SHALL NOT EXCEED 0.25 MM PER SIDE. DIMENSIONS D AND E ARE DETERMINED AT DATUM F.
  5. DATUMS A AND B TO BE DETERMINED AT DATUM F.
  6. A1 IS DEFINED AS THE VERTICAL DISTANCE FROM THE SEATING PLANE TO THE LOWEST POINT ON THE PACKAGE BODY.

| DIM | MILLIMETERS |      |      |
|-----|-------------|------|------|
|     | MIN         | NOM  | MAX  |
| A   | ---         | ---  | 1.10 |
| A1  | 0.00        | 0.05 | 0.15 |
| A2  | 0.75        | 0.85 | 0.95 |
| b   | 0.17        | ---  | 0.27 |
| c   | 0.13        | ---  | 0.23 |
| D   | 2.90        | 3.00 | 3.10 |
| E   | 4.75        | 4.90 | 5.05 |
| E1  | 2.90        | 3.00 | 3.10 |
| e   | 0.50 BSC    |      |      |
| L   | 0.40        | 0.70 | 0.80 |
| L1  | 0.95 REF    |      |      |
| L2  | 0.25 BSC    |      |      |
| θ   | 0°          | ---  | 8°   |

### RECOMMENDED SOLDERING FOOTPRINT\*

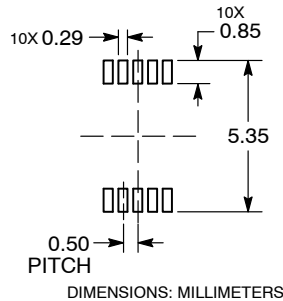

\*For additional information on our Pb-Free strategy and soldering details, please download the ON Semiconductor Soldering and Mounting Techniques Reference Manual, SOLDERRM/D.

### GENERIC MARKING DIAGRAM\*

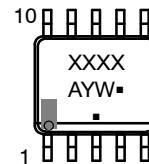

- XXXX = Specific Device Code
- A = Assembly Location
- Y = Year
- W = Work Week
- = Pb-Free Package

(Note: Microdot may be in either location)

\*This information is generic. Please refer to device data sheet for actual part marking. Pb-Free indicator, "G" or microdot "■", may or may not be present and may be in either location. Some products may not follow the Generic Marking.

|                         |                    |  |
|-------------------------|--------------------|--|
| <b>DOCUMENT NUMBER:</b> | <b>98AON34098E</b> | Electronic versions are uncontrolled except when accessed directly from the Document Repository. Printed versions are uncontrolled except when stamped "CONTROLLED COPY" in red. |
| <b>DESCRIPTION:</b>     | <b>MSOP10, 3X3</b> | <b>PAGE 1 OF 1</b>   |

ON Semiconductor and ON are trademarks of Semiconductor Components Industries, LLC dba ON Semiconductor or its subsidiaries in the United States and/or other countries. ON Semiconductor reserves the right to make changes without further notice to any products herein. ON Semiconductor makes no warranty, representation or guarantee regarding the suitability of its products for any particular purpose, nor does ON Semiconductor assume any liability arising out of the application or use of any product or circuit, and specifically disclaims any and all liability, including without limitation special, consequential or incidental damages. ON Semiconductor does not convey any license under its patent rights nor the rights of others.

**onsemi**, **Onsemi**, and other names, marks, and brands are registered and/or common law trademarks of Semiconductor Components Industries, LLC dba "**onsemi**" or its affiliates and/or subsidiaries in the United States and/or other countries. **onsemi** owns the rights to a number of patents, trademarks, copyrights, trade secrets, and other intellectual property. A listing of **onsemi**'s product/patent coverage may be accessed at [www.onsemi.com/site/pdf/Patent-Marking.pdf](http://www.onsemi.com/site/pdf/Patent-Marking.pdf). **onsemi** reserves the right to make changes at any time to any products or information herein, without notice. The information herein is provided "as-is" and **onsemi** makes no warranty, representation or guarantee regarding the accuracy of the information, product features, availability, functionality, or suitability of its products for any particular purpose, nor does **onsemi** assume any liability arising out of the application or use of any product or circuit, and specifically disclaims any and all liability, including without limitation special, consequential or incidental damages. Buyer is responsible for its products and applications using **onsemi** products, including compliance with all laws, regulations and safety requirements or standards, regardless of any support or applications information provided by **onsemi**. "Typical" parameters which may be provided in **onsemi** data sheets and/or specifications can and do vary in different applications and actual performance may vary over time. All operating parameters, including "Typicals" must be validated for each customer application by customer's technical experts. **onsemi** does not convey any license under any of its intellectual property rights nor the rights of others. **onsemi** products are not designed, intended, or authorized for use as a critical component in life support systems or any FDA Class 3 medical devices or medical devices with a same or similar classification in a foreign jurisdiction or any devices intended for implantation in the human body. Should Buyer purchase or use **onsemi** products for any such unintended or unauthorized application, Buyer shall indemnify and hold **onsemi** and its officers, employees, subsidiaries, affiliates, and distributors harmless against all claims, costs, damages, and expenses, and reasonable attorney fees arising out of, directly or indirectly, any claim of personal injury or death associated with such unintended or unauthorized use, even if such claim alleges that **onsemi** was negligent regarding the design or manufacture of the part. **onsemi** is an Equal Opportunity/Affirmative Action Employer. This literature is subject to all applicable copyright laws and is not for resale in any manner.

## PUBLICATION ORDERING INFORMATION

### LITERATURE FULFILLMENT:

Email Requests to: [orderlit@onsemi.com](mailto:orderlit@onsemi.com)

**onsemi Website:** [www.onsemi.com](http://www.onsemi.com)

### TECHNICAL SUPPORT

**North American Technical Support:**

Voice Mail: 1 800-282-9855 Toll Free USA/Canada

Phone: 011 421 33 790 2910

**Europe, Middle East and Africa Technical Support:**

Phone: 00421 33 790 2910

For additional information, please contact your local Sales Representative