

## TO-220 (20W)

### Features

- 20 Watts at 25°C case temperature heat sink mounted
- TO-220 style power package
- Molded case for protection and easy to mount
- Electrically isolated case
- Non-Inductive design

### Applications

- Switching Power Supplies
- Snubbers Circuits
- Automated Machine Controller
- RF Power Amplifiers
- Low Energy Pulse Loading
- UPS
- Voltage Regulation

### Construction

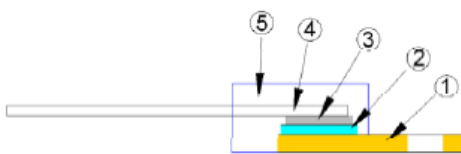

① Radiator Fin	④ Copper Lead
② Alumina Substrate	⑤ Molding
③ Resistor Layer	



### Dimensions

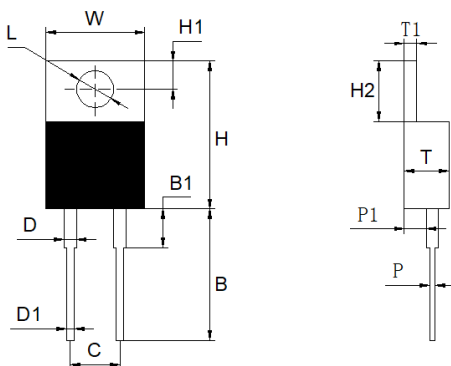

型号	W	H	H1	B	B1	D	D1	L	C	T	T1	H2	P	P1
PRT20 (Unit: mm)	10.16 ±0.25	15.23 ±0.3	2.9 ±0.25	13.5 ±0.8	Max 4	1.26 ±0.1	0.78 ±0.08	3.83 ±0.3	5.08 ±0.25	4.6 ±0.2	1.3 ±0.1	6.25 ±0.35	0.51 ±0.15	2.27 ±0.25

### Part Numbering

TO	220	20W	120R	5%	±50PPM
↓	↓	↓	↓	↓	↓
产品类别	封装	功率	阻值	精度	温度系数
大功率电阻	220	20W	R100: 0.1Ω 0100: 10Ω 4700: 470Ω 1001: 1000Ω 1002: 10000Ω	D=±0.5% F=±1% J=±5% K: ±10%	D: ±50 E: ±100 F: ±200 G: ±300 -:未设定



地址：深圳市龙华新区观澜大布头路南通邦高新产业园 A 栋 8 楼



# 大功率电阻系列规格书

系列号	TO-220
修订日期	2022-02-16
版本号	Ho-A2

## TO-220 (20W)

### Electrical Characteristics Specifications

Resistance Range	TCR (PPM/°C)			
	±0.5%	±1%	±5%	±10%
0.05Ω - 0.1Ω			—	—
>0.1Ω - 1Ω			—	—
>1Ω - 3Ω		±100、±200	±100、±200	±100、±200
>3Ω - 10Ω		±100 ±200	±100 ±200	±100 ±200
>10Ω - 10KΩ	±50 ±100 ±200	±50 ±100 ±200	±50 ±100 ±200	±50 ±100 ±200

- Operating Voltage: 350V max.
- Dielectric Strength: 1800VAC
- Insulation Resistance: 10GΩ min.
- Working Temperature Range: -65°C to +150°C
- Resistance Value < 1Ω is available

### Derating Curve

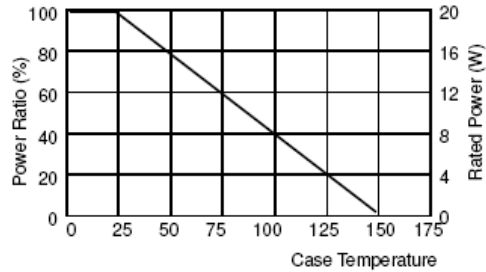

### Environmental Characteristics

Test Item	Requirement	Test Method
Temperature Coefficient of Resistance (T.C.R.)	As Spec.	Referenced to 25°C, ΔR taken at +105°C
Short Time Overload	ΔR±0.3%	2 times rated power with applied voltage not to exceed 1.5 times Maximum continuous operating voltage for 5 seconds
Load Life	ΔR±1.0%	2,000 hours at rated power
Damp Heat with Load	ΔR±0.5%	40±2°C, 90~95% R.H. Max. working voltage for 1000 hrs with 1.5 hrs "ON" and 0.5 hrs "OFF"
Solderability	90% min. coverage	245±5°C for 3 seconds
Thermal Shock	ΔR±0.3%	-65°C~150°C, 100 cycles
Terminal Strength	ΔR±0.2%	(Pull Test) 2.4N
Vibration, High Frequency	ΔR±0.2%	20g peak

- Lead Material: Tinned Copper
- Without a Heat Sink
- When in Free Air at 25°C, the TR20 is Rated for 2.25W
- The Case Temperature is to be used for the Definition of the Applied Power Limit
- The Case Temperature Measurement must be made with a Thermocouple Contacting the Center of the Component mounted on the Designed Heat Sink.
- Thermal Grease should be Applied Properly

地址：深圳市龙华新区观澜大布头路南通邦高新产业园 A 栋 8 楼

系列号	TO-220
修订日期	2022-01-21
版本号	Ho-A2

## TO-220 (30W)

### Features

- 30 Watts at 25°C case temperature heat sink mounted
- TO-220 style power package
- Molded case for protection and easy to mount
- Electrically isolated case
- Non-Inductive design

### Applications

- Switching Power Supplies
- Snubbers Circuits
- Automated Machine Controller
- RF Power Amplifiers.
- Low Energy Pulse Loading
- UPS
- Voltage Regulation

### Construction

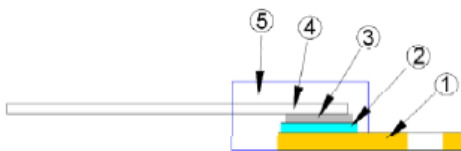

①	Radiator Fin	④	Copper Lead
②	Alumina Substrate	⑤	Molding
③	Resistor Layer		



### Dimensions

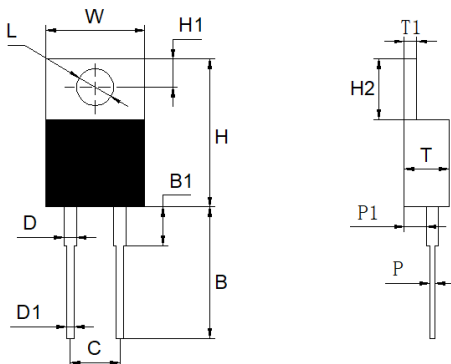

型号	W	H	H1	B	B1	D	D1	L	C	T	T1	H2	P	P1
PRT30 (Unit: mm)	10.16 ±0.25	15.23 ±0.3	2.9 ±0.25	13.5 ±0.8	Max 4	1.26 ±0.1	0.78 ±0.08	3.83 ±0.3	5.08 ±0.25	4.6 ±0.2	1.3 ±0.1	6.25 ±0.35	0.51 ±0.15	2.27 ±0.25

### Part Numbering

产品类别	封装	功率	阻值	精度	温度系数
大功率电阻	220	30W	R100: 0.1Ω 0100: 10Ω 4700: 470Ω 1001: 1000Ω 1002: 10000Ω	D=±0.5% F=±1% J=±5% K: ±10%	D: ±50 E: ±100 F: ±200 G: ±300 -: 未设定



地址：深圳市龙华新区观澜大布头路南通邦高新产业园 A 栋 8 楼

## TO-220 (30W)

### Electrical Characteristics Specifications

Resistance Range	TCR (PPM/°C)			
	±0.5%	±1%	±5%	±10%
0.05Ω - 0.1Ω	—	—	—	—
>0.1Ω - 1Ω	—	—	—	—
>1Ω - 3Ω	—	±100、±200	±100、±200	±100、±200
>3Ω - 10Ω	—	±100 ±200	±100 ±200	±100 ±200
>10Ω - 10KΩ	±50 ±100 ±200	±50 ±100 ±200	±50 ±100 ±200	±50 ±100 ±200

- Operating Voltage: 350V max.
- Dielectric Strength: 1500VAC
- Insulation Resistance: 10GΩ min.
- Working Temperature Range: -65°C to +150°C
- Resistance Value < 1Ω is available

### Derating Curve

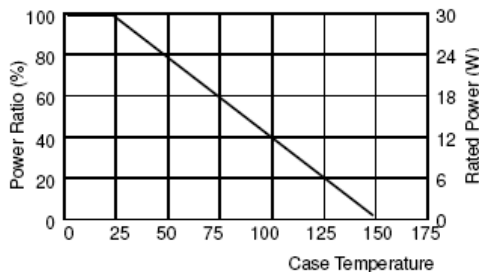

### Environmental Characteristics

Item	Requirement	Test Method
Temperature Coefficient of Resistance (T.C.R.)	As Spec.	Referenced to 25°C, ΔR taken at +105°C
Short Time Overload	ΔR±0.3%	2 times rated power with applied voltage not to exceed 1.5 times maximum continuous operating voltage for 5 seconds
Load Life	ΔR±1.0%	2,000 hours at rated power
Damp Heat with Load	ΔR±0.5%	40±2°C, 90~95% R.H. Max. working voltage for 1000 hrs with 1.5 hrs "ON" and 0.5 hrs "OFF"
Solderability	90% min. coverage	245±5°C for 3 seconds
Thermal Shock	ΔR±0.3%	-65°C~150°C, 100 cycles
Terminal Strength	ΔR±0.2%	(Pull Test) 2.4N
Vibration, High Frequency	ΔR±0.2%	20g peak

- Lead Material: Tinned Copper
- Maximum Torque: 0.9 N-m
- When in Free Air at 25°C, the TR30 is Rated for 2.25W
- The Case Temperature is to be used for the Definition of the Applied Power Limit
- The Case Temperature Measurement must be made with a Thermocouple Contacting the Center of the Component mounted on the Designed Heat Sink.
- Thermal Grease should be Applied Properly

地址：深圳市龙华新区观澜大布头路南通邦高新产业园 A 栋 8 楼

## TO-220 (35W)

### Features

- 35 Watts at 25°C case temperature heat sink mounted
- TO-220 style power package
- Molded case for protection and easy to mount
- Electrically isolated case
- Non-Inductive design

### Applications

- Switching Power Supplies
- Snubbers Circuits
- Automated Machine Controller
- RF Power Amplifiers
- Low Energy Pulse Loading
- UPS
- Voltage Regulation

### Construction

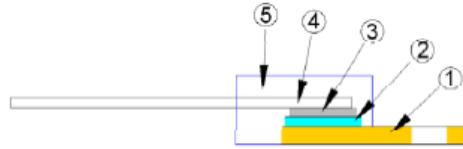

① Radiator Fin	④ Copper Lead
② Alumina Substrate	⑤ Molding
③ Resistor Layer	



### Dimensions

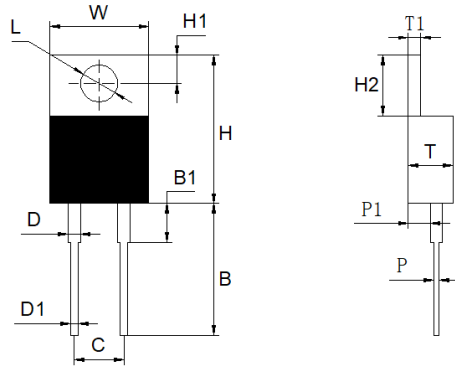

型号	W	H	H1	B	B1	D	D1	L	C	T	T1	H2	P	P1
PRT35 (Unit: mm)	10.16 ±0.25	15.23 ±0.3	2.9 ±0.25	13.5 ±0.8	Max 4	1.26 ±0.1	0.78 ±0.08	3.83 ±0.3	5.08 ±0.25	4.6 ±0.2	1.3 ±0.1	6.25 ±0.35	0.51 ±0.15	2.27 ±0.25

### Part Numbering

产品类别	封装	功率	阻值	精度	温度系数
大功率电阻	220	35W	R100: 0.1Ω 0100: 10Ω 4700: 470Ω 1001: 1000Ω 1002: 10000Ω	D=±0.5% F=±1% J=±5% K: ±10%	D: ±50 E: ±100 F: ±200 G: ±300 -:未设定



地址：深圳市龙华新区观澜大布头路南通邦高新产业园 A 栋 8 楼



# 大功率电阻系列规格书

系列号	TO-220
修订日期	2022-01-21
版本号	Ho-A2

## TO-220 (35W)

### Electrical Characteristics Specifications

Resistance Range	TCR (PPM/°C)			
	±0.5%	±1%	±5%	±10%
0.05Ω - 0.1Ω	—	—	—	—
>0.1Ω - 1Ω	—	—	—	—
>1Ω - 3Ω	—	±100、±200	±100、±200	±100、±200
>3Ω - 10Ω	—	±100 ±200	±100 ±200	±100 ±200
>10Ω - 10KΩ	±50 ±100 ±200	±50 ±100 ±200	±50 ±100 ±200	±50 ±100 ±200

- Operating Voltage: 350V Max.
- Dielectric Strength: 1800VAC
- Insulation Resistance: 10GΩ min.
- Working Temperature Range: -65°C to +150°C
- Resistance Value < 1Ω is available

### Derating Curve

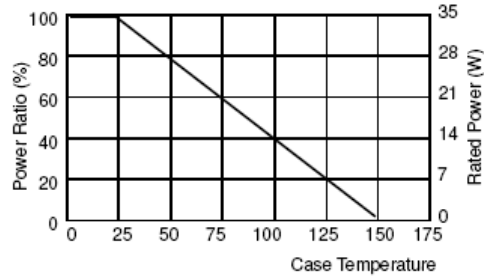

### Environmental Characteristics

Item	Requirement	Test Method
Temperature Coefficient of Resistance (T.C.R.)	As Spec.	Referenced to 25°C, ΔR taken at +105°C
Short Time Overload	ΔR±0.3%	2 times rated power with applied voltage not to exceed 1.5 times maximum continuous operating voltage for 5 seconds
Load Life	ΔR±1.0%	2,000 hours at rated power
Damp Heat with Load	ΔR±0.5%	40±2°C, 90~95% R.H. Max. working voltage for 1000 hrs with 1.5 hrs "ON" and 0.5 hrs "OFF"
Solderability	90% min. coverage	245±5°C for 3 seconds
Thermal Shock	ΔR±0.3%	-65°C~150°C, 100 cycles
Terminal Strength	ΔR±0.2%	(Pull Test) 2.4N
Vibration, High Frequency	ΔR±0.2%	20g peak

- Lead Material: Tinned Copper
- Maximum Torque: 0.9 N-m
- Without a Heat Sink, When in Free Air at 25°C, the TR35 is Rated for 2.50W
- The Case Temperature is to be used for the Definition of the Applied Power Limit
- The Case Temperature Measurement must be made with a Thermocouple Contacting the Center of the Component mounted on the Designed Heat Sink.
- Thermal Grease should be Applied Properly.

地址：深圳市龙华新区观澜大布头路南通邦高新产业园 A 栋 8 楼

## TO-220 (50W)

### Features

- 50 Watts at 25°C case temperature heat sink mounted
- TO-220 style power package
- Molded case for protection and easy to mount
- Electrically isolated case
- Non-Inductive design

### Applications

- Switching Power Supplies
- Snubbers Circuits
- Automated Machine Controller
- RF Power Amplifiers.
- Low Energy Pulse Loading
- UPS
- Voltage Regulation

### Construction

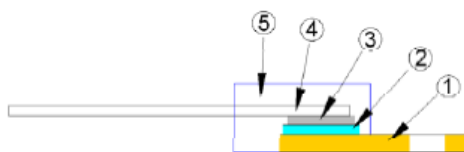

① Radiator Fin	④ Copper Lead
② Alumina Substrate	⑤ Molding
③ Resistor Layer	



### Dimensions

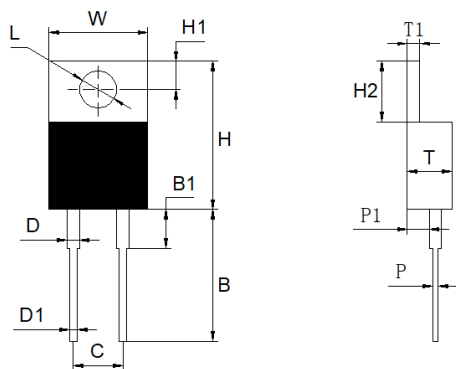

型號	W	H	H1	B	B1	D	D1	L	C	T	T1	H2	P	P1
PRT50 (Unit: mm)	10.16 ±0.25	15.23 ±0.3	2.9 ±0.25	13.5 ±0.8	Max 4	1.26 ±0.1	0.78 ±0.08	3.83 ±0.3	5.08 ±0.25	4.6 ±0.2	1.3 ±0.1	6.25 ±0.35	0.51 ±0.15	2.27 ±0.25

### Part Numbering

产品类别	封装	功率	阻值	精度	温度系数
大功率电阻	220	50W	R100: 0.1Ω 0100: 10Ω 4700: 470Ω 1001: 1000Ω 1002: 10000Ω	D=±0.5% F=±1% J=±5% K: ±10%	D: ±50 E: ±100 F: ±200 G: ±300 -:未设定



地址：深圳市龙华新区观澜大布头路南通邦高新产业园 A 栋 8 楼

## TO-220 (50W)

### Electrical Characteristics Specifications

Resistance Range	TCR (PPM/°C)			
	±0.5%	±1%	±5%	±10%
0.05Ω - 0.1Ω	—	—	—	—
>0.1Ω - 1Ω	—	—	—	—
>1Ω - 3Ω	—	±100、±200	±100、±200	±100、±200
>3Ω - 10Ω	—	±100 ±200	±100 ±200	±100 ±200
>10Ω - 10KΩ	±50 ±100 ±200	±50 ±100 ±200	±50 ±100 ±200	±50 ±100 ±200

- Operating Voltage: 350V Max.
- Dielectric Strength: 1800VAC
- Insulation Resistance: 10GΩ min.
- Working Temperature Range: -65°C to +150°C
- Resistance Value < 1Ω is available

### Derating Curve

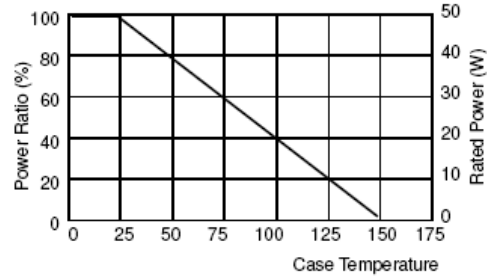

### Environmental Characteristics

Item	Requirement	Test Method
Temperature Coefficient of Resistance (T.C.R.)	As Spec.	Referenced to 25°C, ΔR taken at +105°C
Short Time Overload	ΔR±0.3%	2 times rated power with applied voltage not to exceed 1.5 times maximum continuous operating voltage for 5 seconds
Load Life	ΔR±1.0%	2,000 hours at rated power
Damp Heat with Load	ΔR±0.5%	40±2°C, 90~95% R.H. Max. working voltage for 1000 hrs with 1.5 hrs "ON" and 0.5 hrs "OFF"
Solderability	90% min. coverage	245±5°C for 3 seconds
Thermal Shock	ΔR±0.3%	-65°C~150°C, 100 cycles
Terminal Strength	ΔR±0.2%	(Pull Test) 2.4N
Vibration, High Frequency	ΔR±0.2%	20g peak

- Lead Material: Tinned Copper
- Maximum Torque: 0.9 N-m
- Without a Heat Sink, When in Free Air at 25°C, the TR50 is Rated for 3W.
- The Case Temperature is to be used for the Definition of the Applied Power Limit.
- The Case Temperature Measurement must be made with a Thermocouple Contacting the Center of the Component mounted on the Designed Heat Sink.
- Thermal Grease should be Applied Properly.

地址：深圳市龙华新区观澜大布头路南通邦高新产业园 A 栋 8 楼



## TO-247 (100W)

### Construction

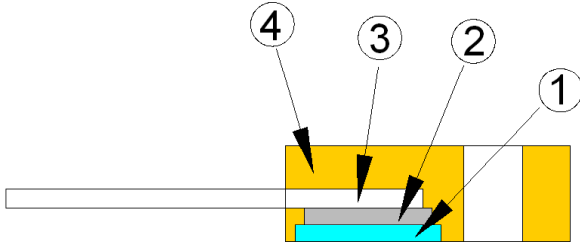

① Alumina Substrate	③ Lead
② Resistor Layer	④ Molding



### Features

- 100 Watts at 25°C case temperature heat sink mounted
- TO-247 style power package
- Single M3 screw mounting to heat sink
- Molded case for protection and easy to mount
- Electrically isolated case
- Non-Inductive design

### Applications

- Gate Resistors in Power Supplies
- Snubbers
- Load and Dumping Resistors in CRT Monitors
- Terminal Resistance in RF Power Amplifier
- Voltage Regulation
- Low Energy Pulse Loading
- UPS

### Dimensions

Type	Weight (g) (1000pcs)
TR100	3381

Unit: mm

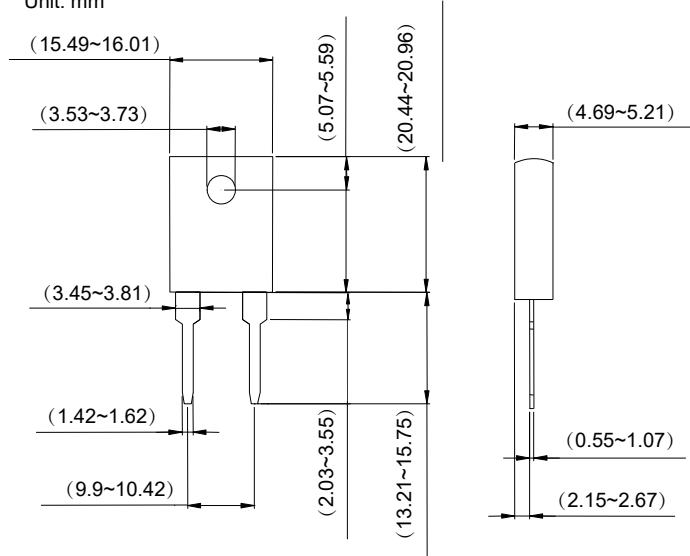

### Part Numbering

T0	247	100W	15R	5%	±50PPM
↓	↓	↓	↓	↓	↓
产品类别	封装	功率	阻值	精度	温度系数
大功率电阻	247	100W	R100: 0.1Ω 0100: 10Ω 4700: 470Ω 1001: 1000Ω 1002: 10000Ω	D=±0.5% F=±1% J=±5% K: ±10%	D: ±50 E: ±100 F: ±200 G: ±300



# TO-247大功率电阻系列规格书

系列号	TO-247
修订日期	2022-02-18
版本号	Ho-A2

## TO-247 (100W)

### Electrical Characteristics Specifications

Resistance Range	TCR (PPM/°C)		
	±1%	±5%	±10%
0.05Ω - 1Ω		—	—
>1Ω - 3Ω	±300		
>3Ω - 10Ω	±100 ±200	±100 ±200	±100 ±200
>10Ω - 10KΩ	±50 ±100 ±200	±50 ±100 ±200	±50 ±100 ±200

- Operating Voltage: 350V Max.
- Dielectric Strength: 1800V AC
- Insulation Resistance: 10GΩ min.
- Working Temperature Range: -65°C to +175°C

### Derating Curve

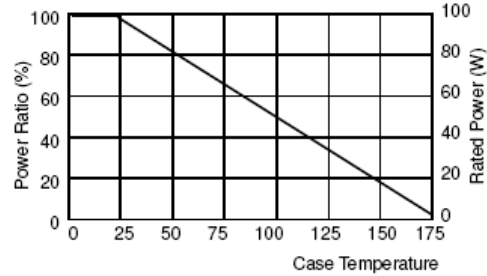

### Environmental Characteristics

Item	Requirement	Test Method
Temperature Coefficient of Resistance (T.C.R.)	As Spec.	Referenced to 25°C, ΔR taken at +105°C
Load Life	ΔR±1.0%	Rated power, 2,000 hours
Solderability	90% min. coverage	245±5°C for 3 seconds
Momentary Overload	ΔR±0.5%	1.5 times rated power and V (dc) ≤ 1.5V Max. for 5 seconds
Dielectric strength	ΔR±0.15%	1800v AC, 60 seconds
Moisture resistance	ΔR±0.5%	-10°C~+65°C, RH>90%, cycle 240 hours
Thermal Shock	ΔR±0.5%	-65°C~150°C, 100 cycles
Terminal Strength	ΔR±0.2%	(Pull Test) 2.4N
Vibration, High Frequency	ΔR±0.4%	20g peak

- Lead Material: Tinned Copper
- When in Free Air at 25°C, the TR100 is Rated for 3.5W
- The Case Temperature is to be used for the Definition of the Applied Power Limit
- The Case Temperature Measurement must be made with a Thermocouple Contacting the Center of the Component mounted on the Designed Heat Sink
- Thermal Grease should be Applied Properly.

**TO-247 封装，厚膜和薄膜技术，符合AEC-Q200 认证功率可达 140W热阻 0.9°C/W极好的频率特性**

**使用厚膜和薄膜两种电阻技术的 TO-247封装功率电阻**

相比较厚膜电阻技术，薄膜电阻可以提供更好的温飘和精度。 HoNP100系列产品在10R-51KΩ的阻值范围内使用金属化薄膜电阻技术，不仅可以实现高达140W的功率，而且可以提供50ppm的温飘和1% 的阻值精度。本系列在0.02-510K Ω的阻值范围内也可以提供标准厚膜电阻技术。

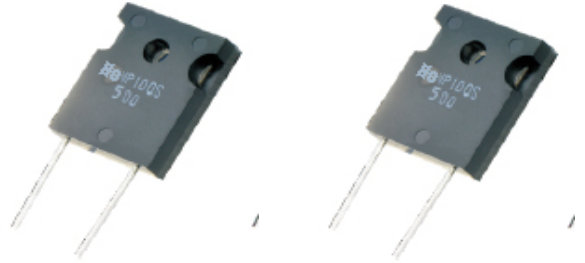

系列	功率	阻值范围	阻值标准	温飘	可选精度	电阻技术	热阻	绝缘电压	最大工作电流	工作温度	频率特性	
											并联电容	串联电感
HoNP100H	140W	0.05-0.091	E12	±250ppm	±5%	厚膜	0.9°C/W	2000VAC	25A	-55~+155°C	4.5pF	13nH
HoNP100A	140W	0.1-9.9R	E24	±100ppm	±1%, ±5%	厚膜	0.9°C/W	2000VAC	25A	-55~+155°C	4.5pF	13nH
HoNP100C	140W	10-51K	E24	±50ppm	±1%	薄膜	0.9°C/W	2000VAC	25A	-55~+155°C	4.5pF	13nH

**规格和参数**

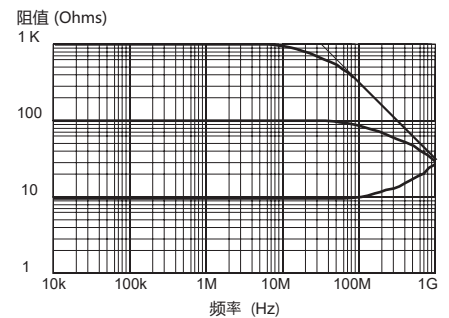
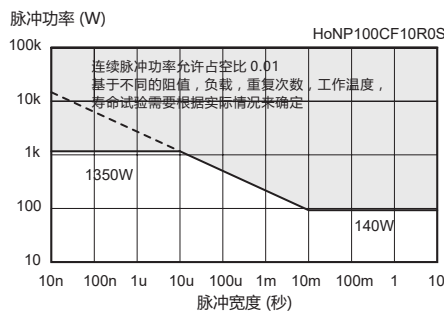
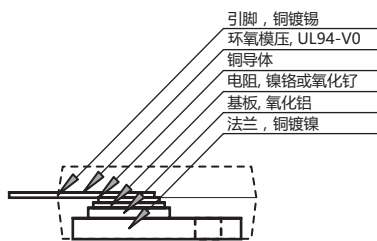
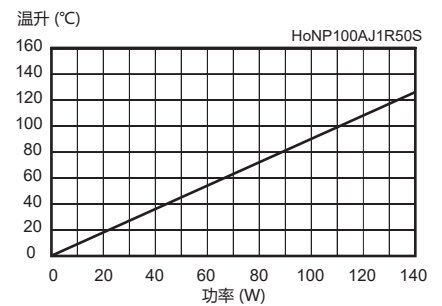
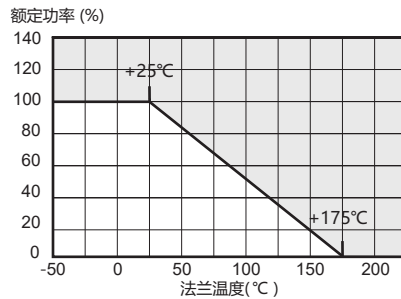
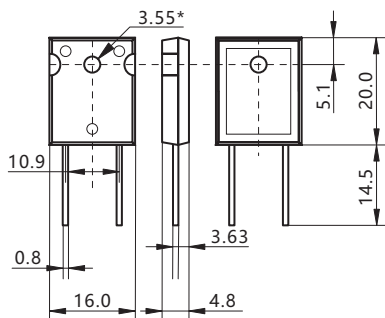

**选型表**

选型示例: HoNP100CF10R0S (RNP100C, ±50ppm/°C, 10R, ±1% 标准品)



<b>系列号</b> HoNP100H HoNP100A HoNP100C	<b>精度</b> F=±1% J=±5%	<b>阻值编码</b> R020=0.02R    1R00=1R 10R0=10R    1000=100R 1001=1K    1002=10K 1003=100K    5103=510K	<b>定制编码</b> S=标准品 A-Z=识别码
--	-----------------------------	--	---------------------------------

