

■ Features

- Metallization on ferrite core results in excellent shock resistance and damage-free durability.
- Closed magnetic circuit design reduces leakage flux and Electro Magnetic Interference(EMI).
- Fe base metal material core provides large saturation current.
- Automatic production ensures high quality and consistency.

■ Applications

- Protects AC side from the affects of switching regulators.
- Provides noise elimination and immunity for TVs,TVRs/VCRs,audio equipmens.

■ Product Identification

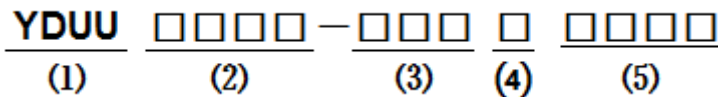

- (1) : Type
- (2) : Dimensions
- (3) : Inductance
- (4) : L=Vertical, W=Horizontal
- (5) : Internal code

■ Shapes and Dimensions (Unit: mm)

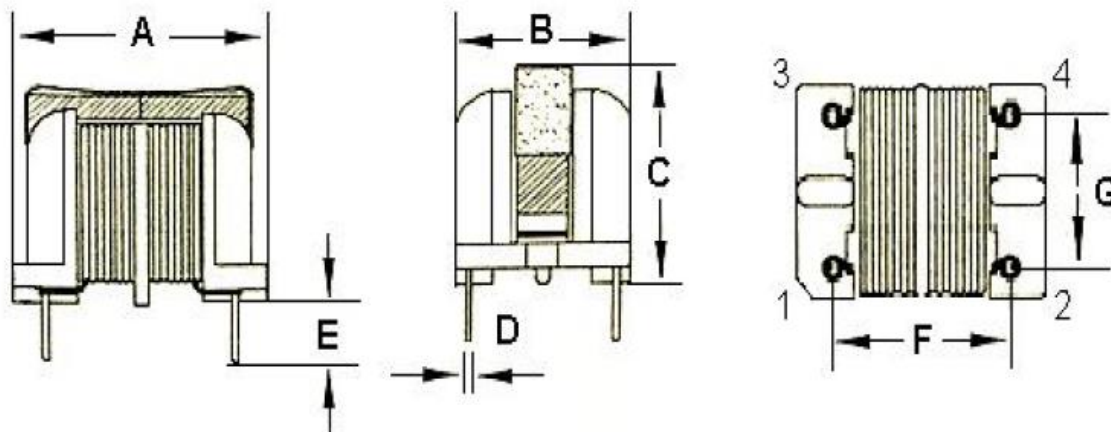

Part Number	A	B	C Max.	D	E	F	G
YDUU10.5-253L0321	19.0	17.0	22.0	0.7±0.1	3.5±0.5	13.0±0.5	10.0±0.5

Schematic Diagram

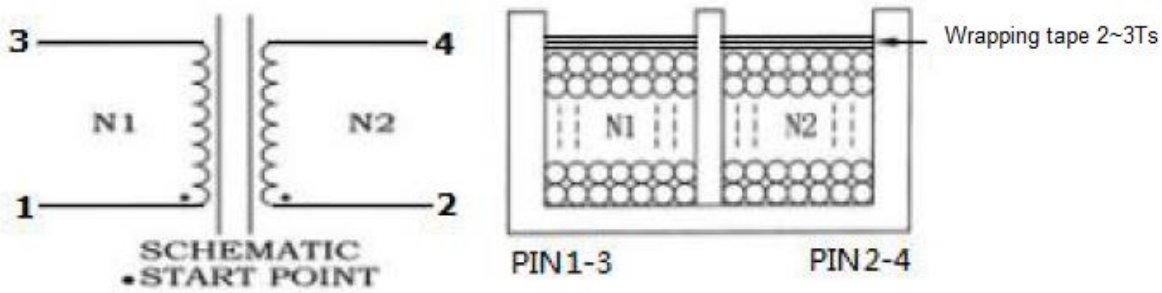

Electrical Characteristics

ITEM	PIN NO.	SPEC.	CONDITION	EQUIPMENT
INDUCTANCE	L(1-3),L(2-4)	N1=N2: 25mH(Min)	LCZ1061/1062	1KHz/0.25V/25-30℃
L DIFFERENCE	L(1-3),L(2-4)	0.3mH(Max)	LCZ1061/1062	1KHz/0.25V/25-30℃
WITHSTAND VOLTAGE	L(1-3)-L(2-4) COIL-CORE	AC 1500V/50Hz	TOS5030	1mA/60S

Winding Structure

WINDING	S	F	MAGNET WIRE	TURNS	WINDING TYPE
N1	1	3	2UEW Φ0.32x1C	90Ts Ref	CLOSE WINDING
N2	2	4	2UEW Φ0.32x1C	90Ts Ref	CLOSE WINDING

Material List

No.	Item	Material Spec.	Manufacturer (or of the same quality)
1	CORE	UU10.5(AL:4.5K)	Shandong Hengrui magnetolectric Technology Co.,Ltd
2	WIRE	2UEW/155℃	Dongguan Yida Industrial Co.,Ltd
3	BOBBIN	UU10.5 T375J	Changchun Plastics Co.,Ltd
4	CLAMP	UU10.5	Wan Jie Co.,Ltd
5	VARNISH	T1148-1	YueYang Green Technology Co.,Ltd

■ Technological Requirements

- 1, After soaking in oil, the product should be completely penetrated and dried. The finished product has neat appearance and good solderability of pins.
- 2, The product is vertical. The two windings are separately wrapped with yellow tape.
- 3, Top printing: UU10.5-25mH

■ Packaging requirements

- 1, The products shall be packed in layers and intervals. If it is less than one box, padding shall be added to prevent impact, collision, etc.
- 2, The cartoon box outside the package shall be marked with the model name, quantity, ex factory date and the name of the manufacturer of the product;
- 3, After the goods arrive at the customer, the seal of the packing box shall be intact, the box shall be free of damage and cracking, and the packing materials in the box shall be free of damage.