

Specifications

- Current rating: 9A AC, DC Max
- Voltage rating: 600V AC, DC
- Temperature range: -40°C ~ +105°C
- Contact resistance: 10mΩ Max.
- Insulation resistance: 1000MΩ Min.
- Withstanding voltage: 1500V AC/minute
- *Compliant with RoHS and REACH*
- *Meet the HF/Halogen Free, GWT/Glow wire Test (IEC60335-1) request, need to customize*
- *Contact CJT for details*

Standards

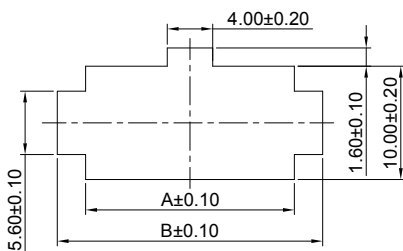

Panel hole layout

DUAL ROW

RECOMMENDED PANEL CUT-OUT
(DESIGNED FOR 0.80mm TO 2.00mm THICK
STAMPED PANEL OR PRINTED CIRCUIT BOARD)

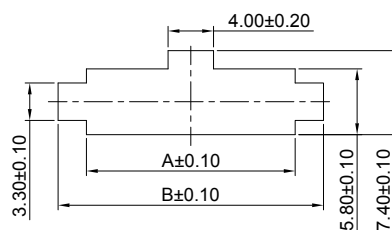

SINGLE ROW

RECOMMENDED PANEL CUT-OUT
(DESIGNED FOR 0.80mm TO 2.00mm THICK
STAMPED PANEL OR PRINTED CIRCUIT BOARD)

PART NO.		Dimensions	
SINGLE ROW	DUAL ROW	A	B
-----	C4201HM-2x1P	5.80	10.80
C4201HM-2P	C4201HM-2x2P	10.00	15.00
C4201HM-3P	C4201HM-2x3P	14.20	19.20
C4201HM-4P	C4201HM-2x4P	18.40	23.40
C4201HM-5P	C4201HM-2x5P	22.60	27.60
C4201HM-6P	C4201HM-2x6P	26.80	31.80
C4201HM-7P	C4201HM-2x7P	31.00	36.00
C4201HM-8P	C4201HM-2x8P	35.20	40.20
C4201HM-9P	C4201HM-2x9P	39.40	44.40
C4201HM-10P	C4201HM-2x10P	43.60	48.60
C4201HM-11P	C4201HM-2x11P	47.80	52.80
C4201HM-12P	C4201HM-2x12P	52.00	57.00

Unit:mm

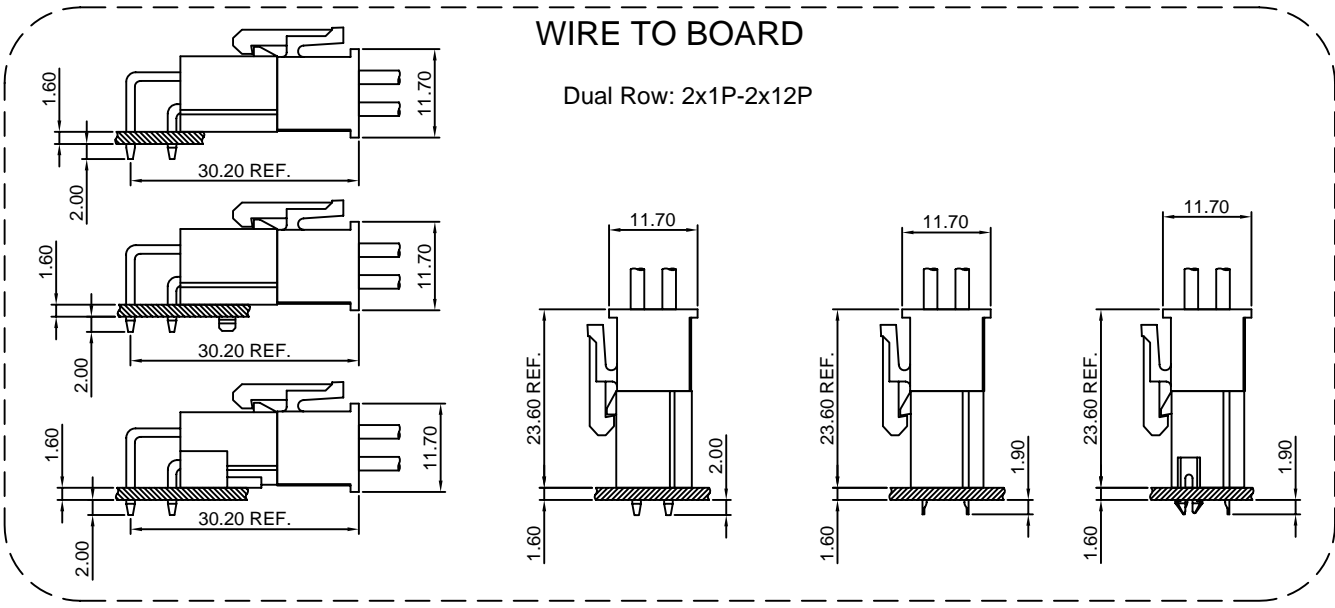
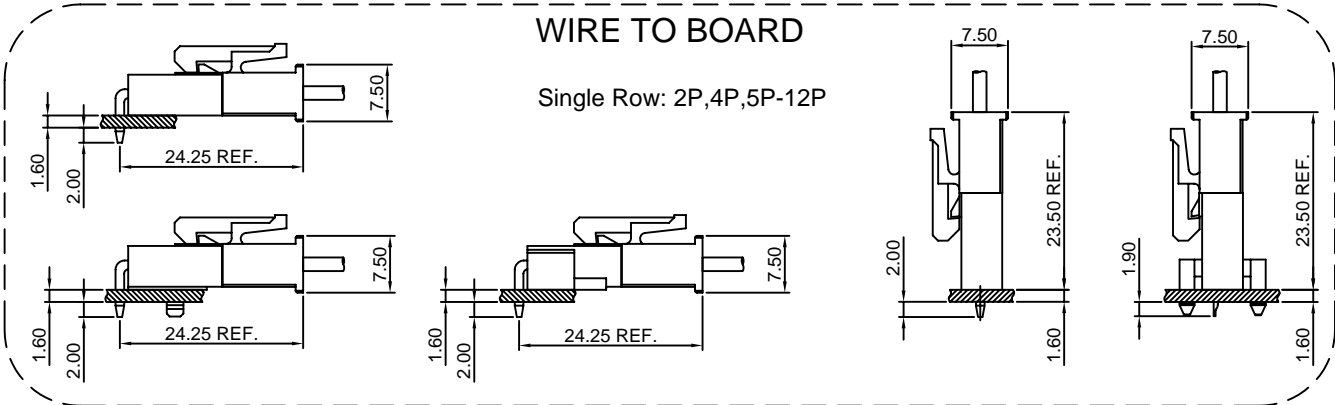
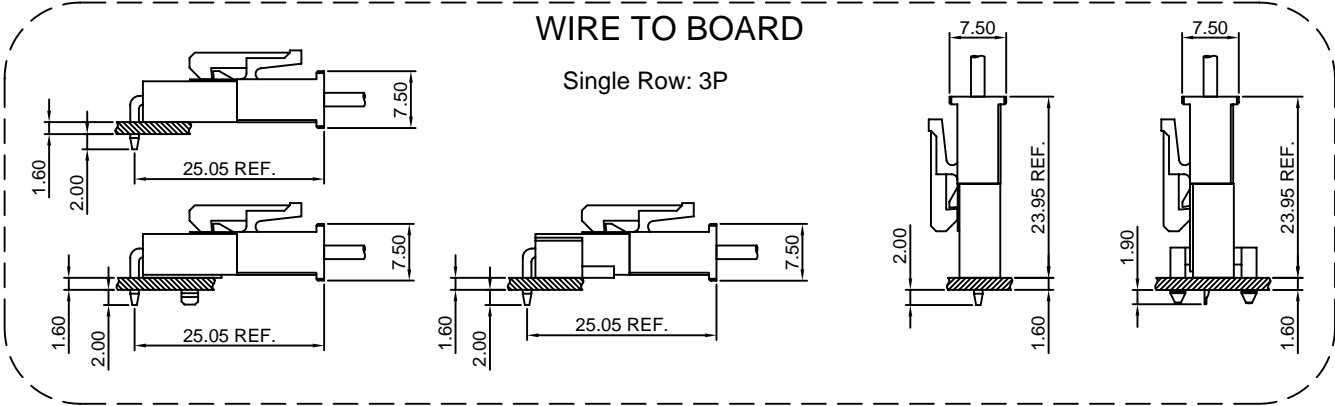
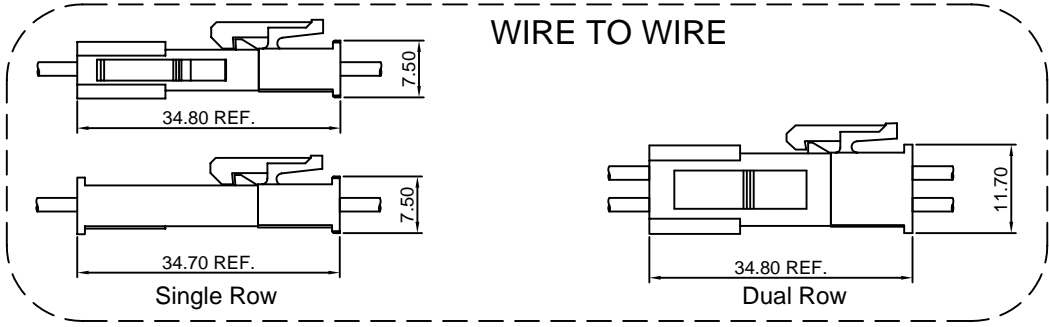
Assembly layout



C4201HF

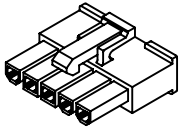

C4201HF

C4201HM

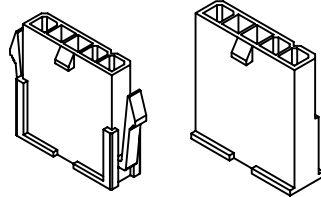

C4201HM

C4201HMA

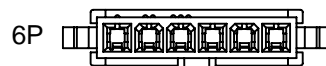
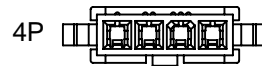
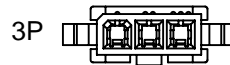
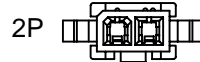
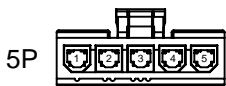
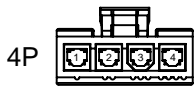

C4201WV C4201WVA-F

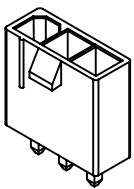

C4201WV

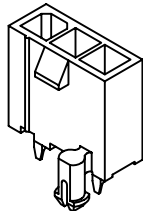

C4201WVA-F

C4201WR C4201WR-E

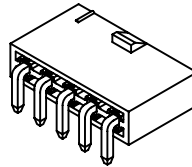

C4201WR

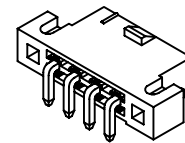

C4201WR-E

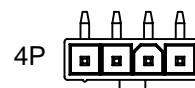
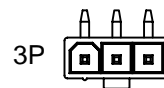

C4201HF-2

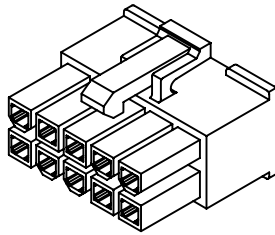

C4201HF-2

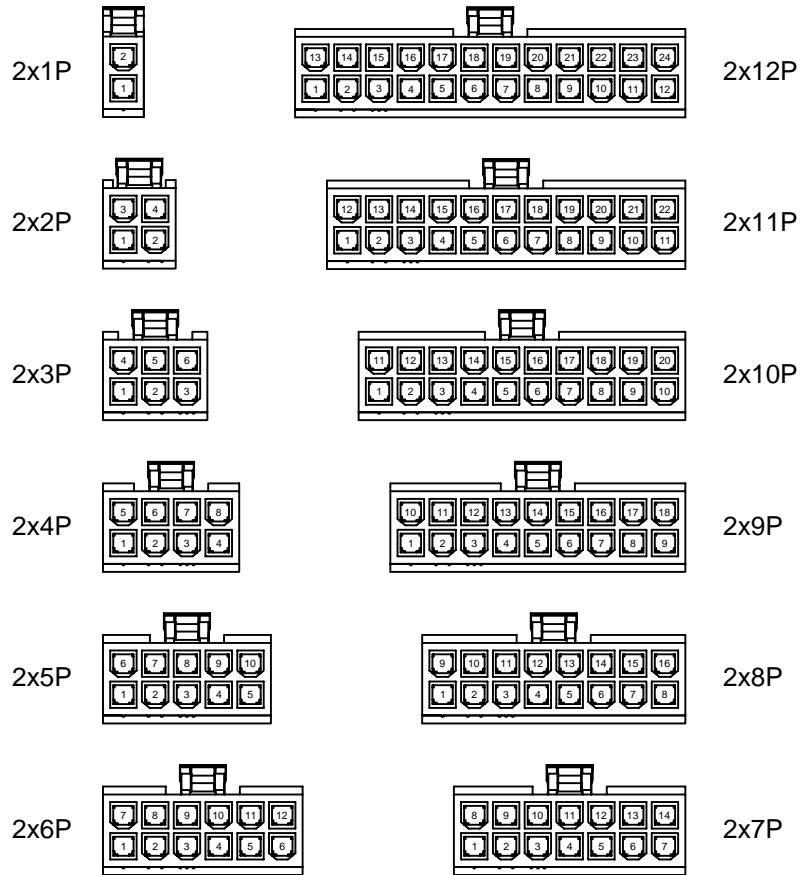

C4201HM-2 C4201HMA-2

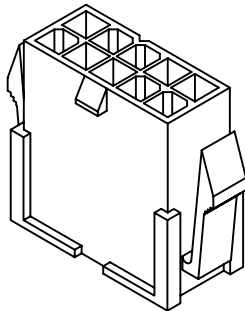

C4201HM-2

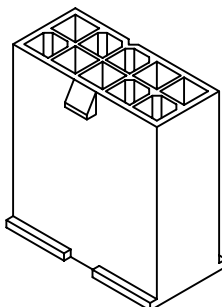

C4201HMA-2

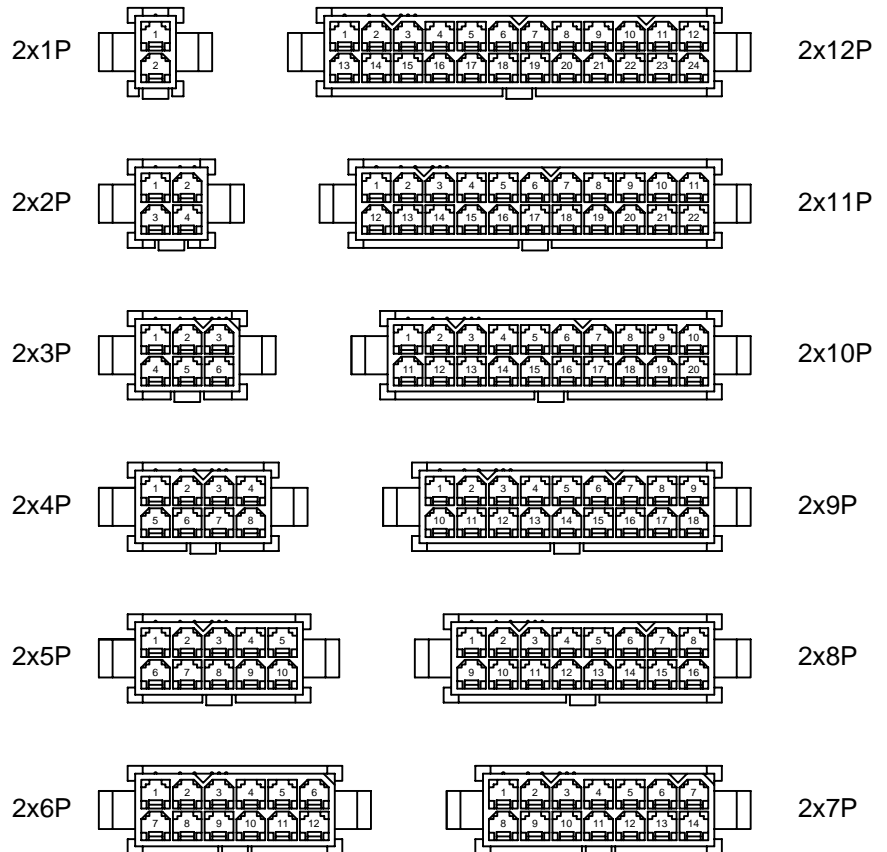

C4201WV-2 C4201WVA-2 C4201WVA-F-2

C4201WV-2		2x1P			2x12P
		2x2P			2x11P
C4201WVA-2		2x3P			2x10P
		2x4P			2x9P
C4201WVA-F-2		2x5P			2x8P
		2x6P			2x7P

C4201WR-2 C4201WR-E-2 C4201WR-F-2

C4201WR-2		2x1P			2x12P
		2x2P			2x11P
C4201WR-E-2		2x3P			2x10P
		2x4P			2x9P
C4201WR-F-2		2x5P			2x8P
		2x6P			2x7P

C4201HFA-2

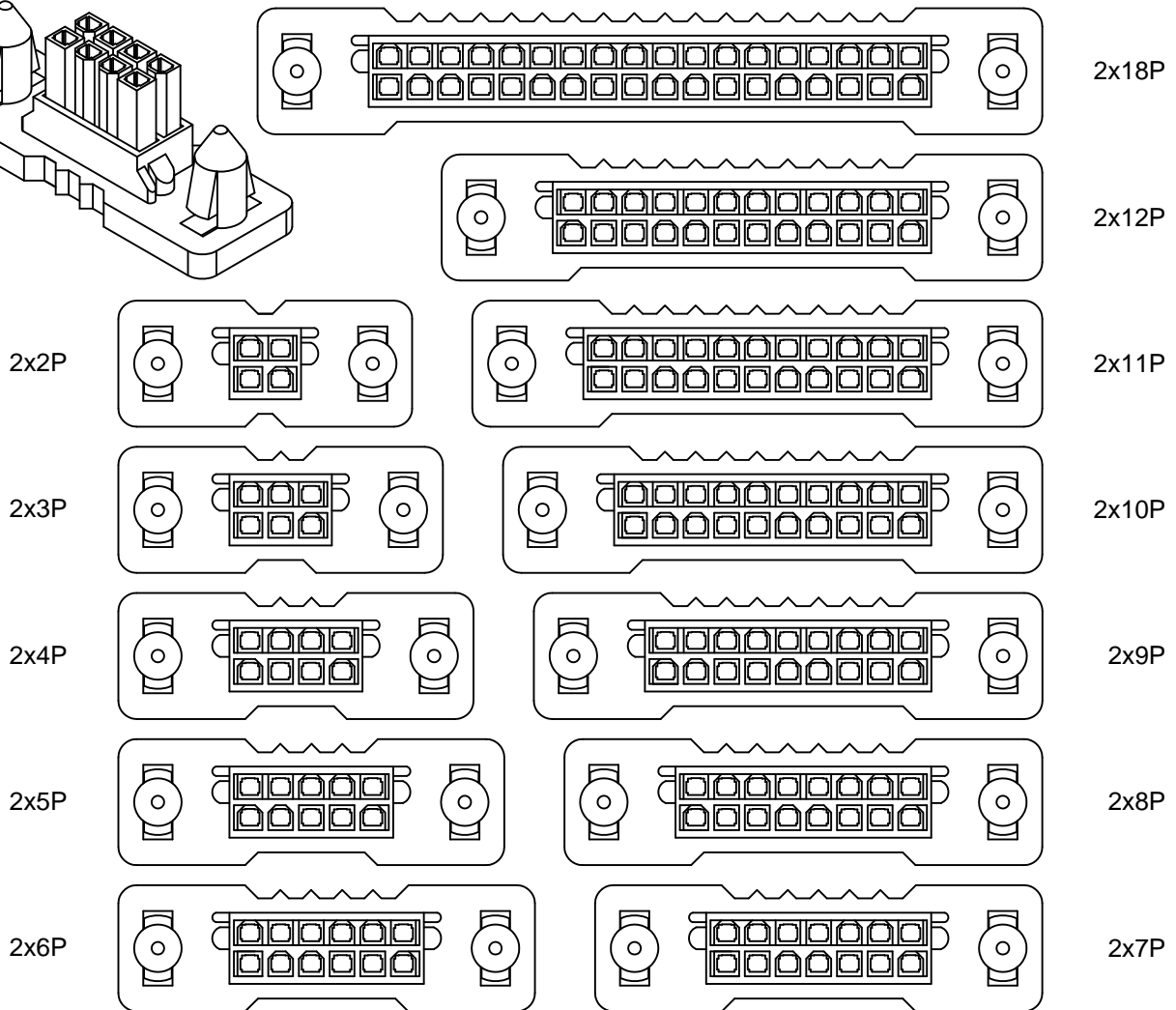
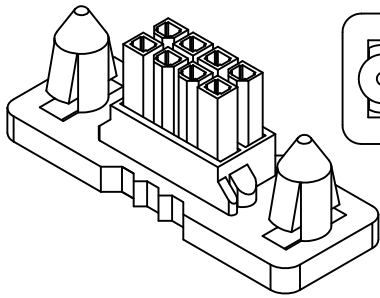

C4201HV-2

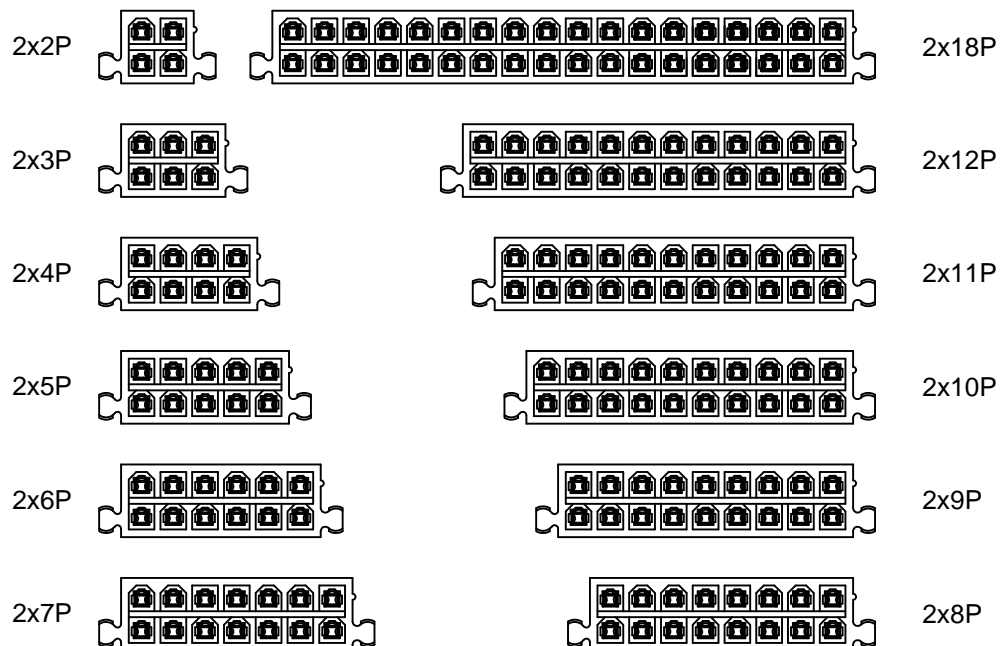
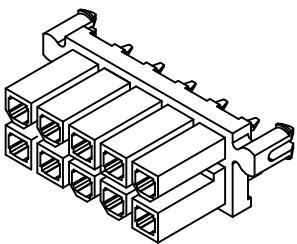

C4201HMB-2

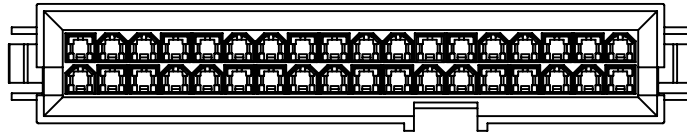
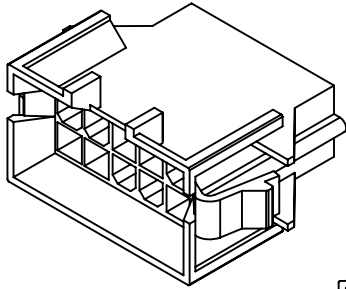

2x18P

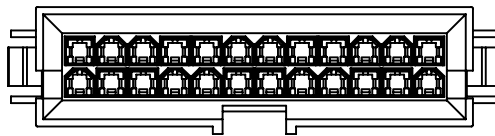

2x12P

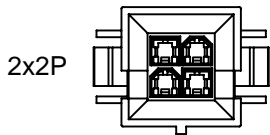

2x2P

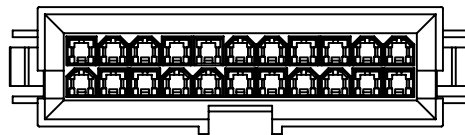

2x11P

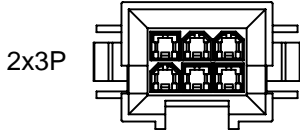

2x3P

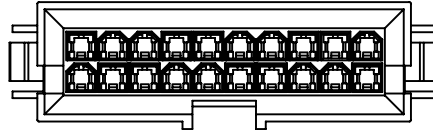

2x10P

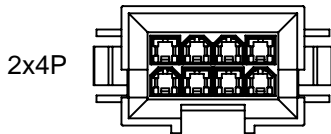

2x4P

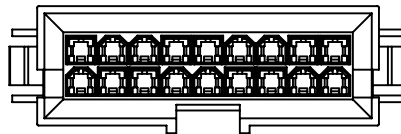

2x9P

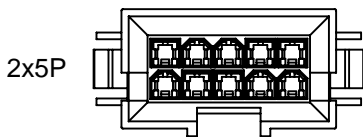

2x5P

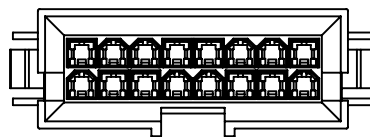

2x8P

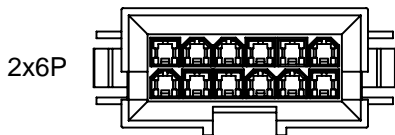

2x6P

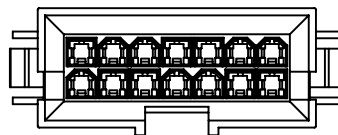

2x7P

C4201WVA-F1-2

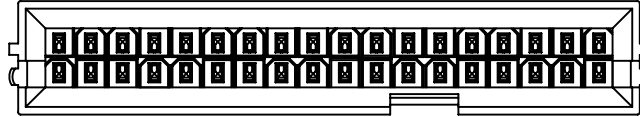
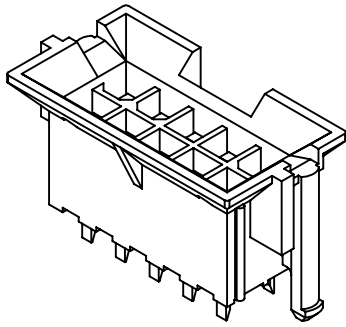

2x18P

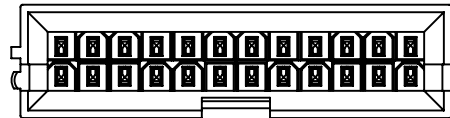

2x12P

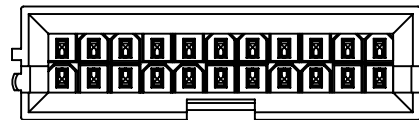
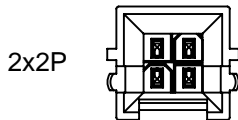

2x11P

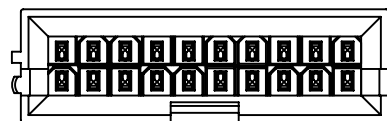
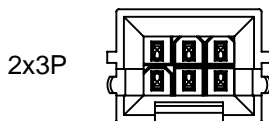

2x10P

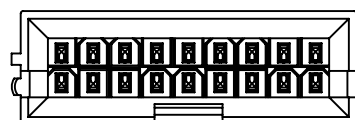
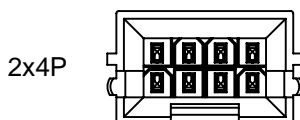

2x9P

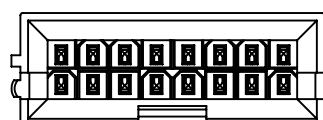
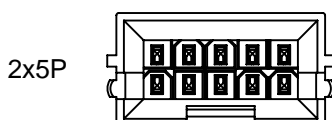

2x8P

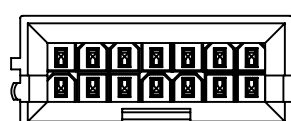
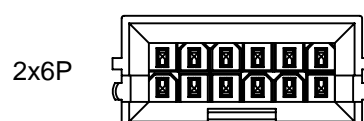

2x7P

C4201WR-F1-2

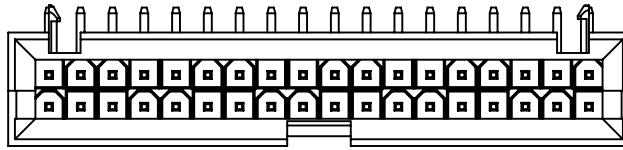
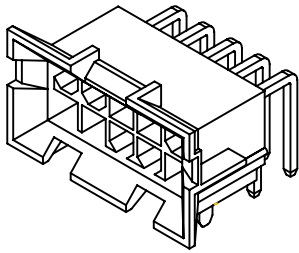

2x18P

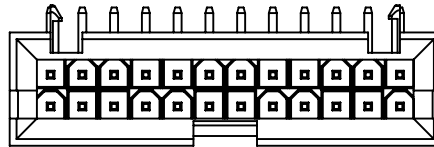

2x12P

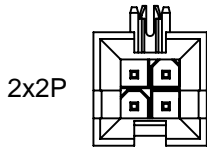

2x2P

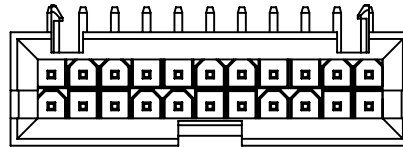

2x11P

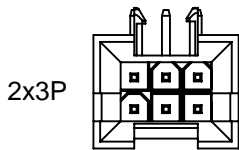

2x3P

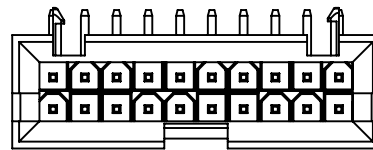

2x10P

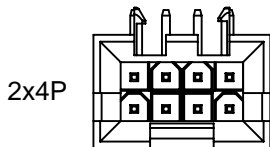

2x4P

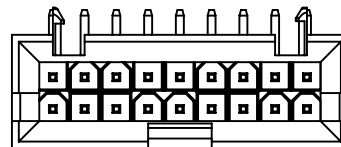

2x9P

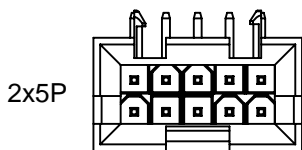

2x5P

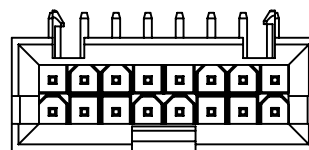

2x8P

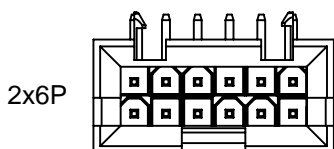

2x6P

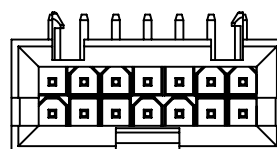

2x7P

C4201F-T

4.20mm pitch Crimp Terminal

Reference Informations:

*Used in CJT C4201HF-XP, C4201HF, HFA, HFC-2xXP, C4201HF-2x3P-A/B, C4201HF-2x4P-A/B series Housing

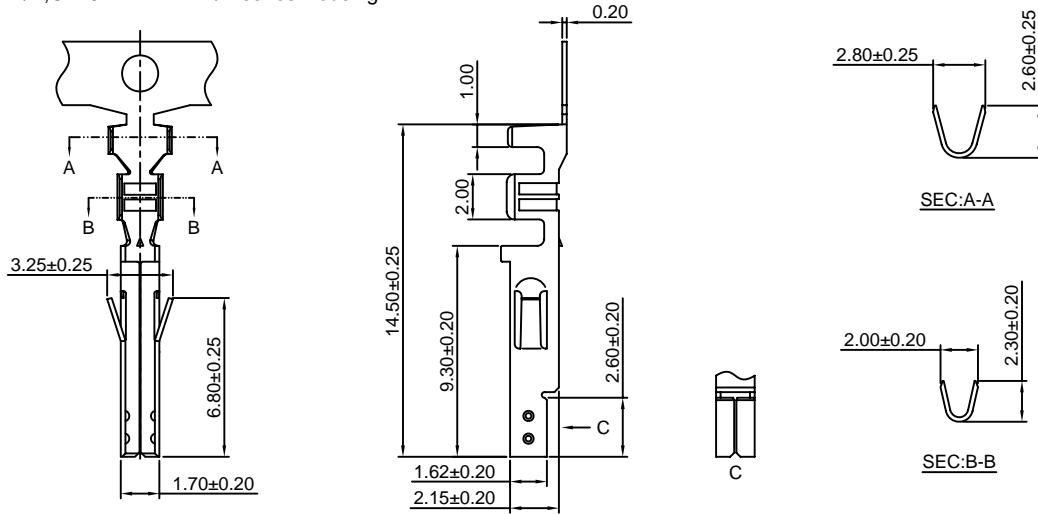

Ordering information & Specifications:

Unit:mm

Part NO.	Wire Range	Insulation O.D.	Material	Finish	Qty/reel
C4201F-TB	AWG#22-#28	1.80mm(max)	Brass	Tin over Nickel	10,000 PCS
C4201F-TP	AWG#22-#28	1.80mm(max)	Phosphor Bronze	Tin over Nickel	10,000 PCS
C4201F-GB	AWG#22-#28	1.80mm(max)	Brass	Gold over Nickel	10,000 PCS
C4201F-GP	AWG#22-#28	1.80mm(max)	Phosphor Bronze	Gold over Nickel	10,000 PCS
C4201F-TCA	AWG#22-#28	1.80mm(max)	Copper Alloy	Tin over Nickel	10,000 PCS
C4201F-GCA	AWG#22-#28	1.80mm(max)	Copper Alloy	Gold over Nickel	10,000 PCS

Optional Gold plating available but MOQ requested

C4201M-T

4.20mm pitch Crimp Terminal

Reference Informations:

*Used in CJT C4201HM, HMA-XP, C4201HM, HMA, HMB-2xXP, C4201HM-2xXP-A series Housing

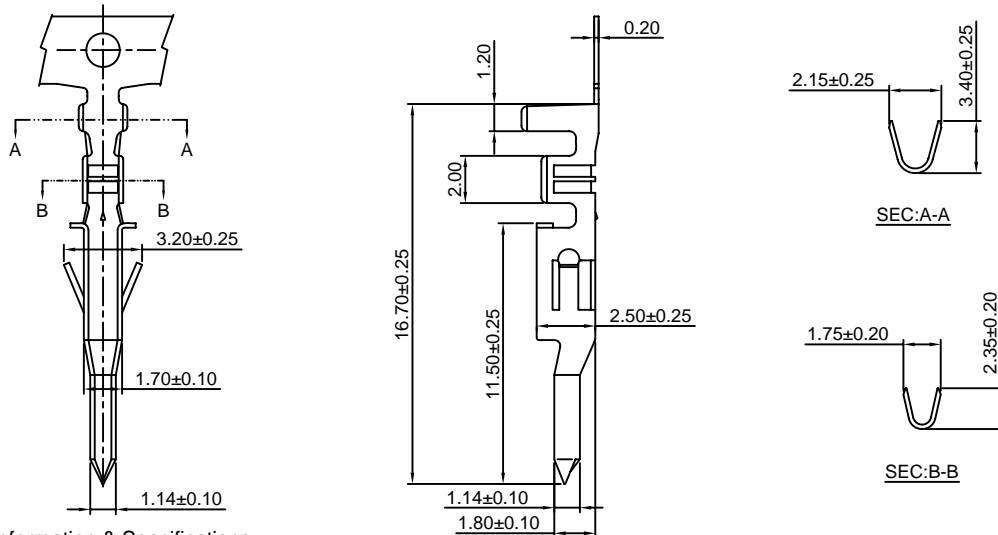

Ordering information & Specifications:

Unit:mm

Part NO.	Wire Range	Insulation O.D.	Material	Finish	Qty/reel
C4201M-TB	AWG#22-#28	1.80mm(max)	Brass	Tin over Nickel	5,000 PCS
C4201M-TP	AWG#22-#28	1.80mm(max)	Phosphor Bronze	Tin over Nickel	5,000 PCS
C4201M-GB	AWG#22-#28	1.80mm(max)	Brass	Gold over Nickel	5,000 PCS
C4201M-GP	AWG#22-#28	1.80mm(max)	Phosphor Bronze	Gold over Nickel	5,000 PCS
C4201M-TCA	AWG#22-#28	1.80mm(max)	Copper Alloy	Tin over Nickel	5,000 PCS
C4201M-GCA	AWG#22-#28	1.80mm(max)	Copper Alloy	Gold over Nickel	5,000 PCS

Optional Gold plating available but MOQ requested

C4201F-T-H

4.20mm pitch Crimp Terminal

Reference Informations:

*Used in CJT C4201HF-XP, C4201HF, HFA, HFC-2xXP, C4201HF-2x3P-A/B, C4201HF-2x4P-A/B series Housing

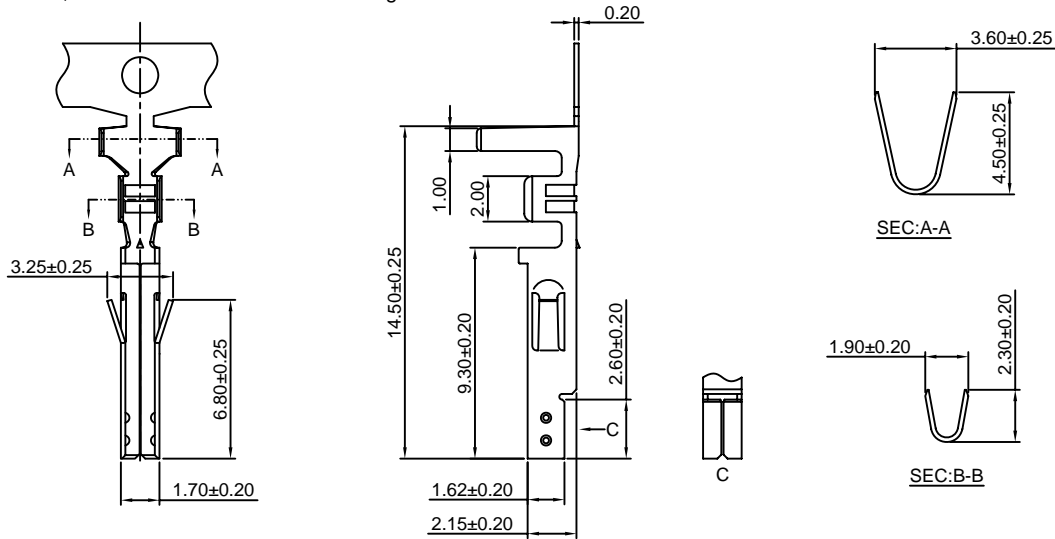

Ordering information & Specifications:

Unit:mm

Part NO.	Wire Range	Insulation O.D.	Material	Finish	Qty/reel
C4201F-TB-H	AWG#18-#24	3.10mm(max)	Brass	Tin over Nickel	4,500 PCS
C4201F-TP-H	AWG#18-#24	3.10mm(max)	Phosphor Bronze	Tin over Nickel	4,500 PCS
C4201F-GB-H	AWG#18-#24	3.10mm(max)	Brass	Gold over Nickel	4,500 PCS
C4201F-GP-H	AWG#18-#24	3.10mm(max)	Phosphor Bronze	Gold over Nickel	4,500 PCS

Optional Gold plating available but MOQ requested

C4201M-T-H

4.20mm pitch Crimp Terminal

Reference Informations:

*Used in CJT C4201HM, HMA-XP, C4201HM, HMA, HMB-2xXP, C4201HM-2xXP-A series Housing

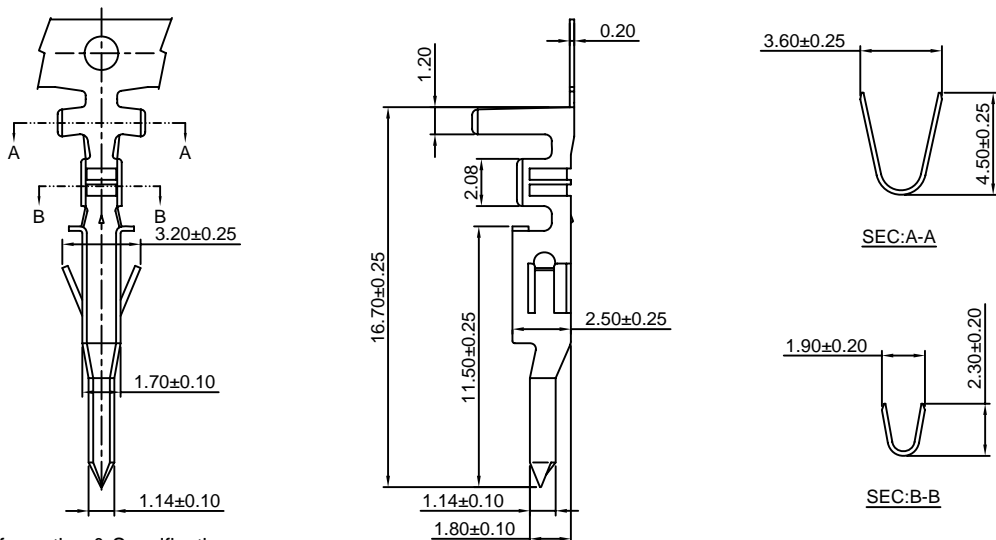

Ordering information & Specifications:

Unit:mm

Part NO.	Wire Range	Insulation O.D.	Material	Finish	Qty/reel
C4201M-TB-H	AWG#18-#24	3.10mm(max)	Brass	Tin over Nickel	4,000 PCS
C4201M-TP-H	AWG#18-#24	3.10mm(max)	Phosphor Bronze	Tin over Nickel	4,000 PCS
C4201M-GB-H	AWG#18-#24	3.10mm(max)	Brass	Gold over Nickel	4,000 PCS
C4201M-GP-H	AWG#18-#24	3.10mm(max)	Phosphor Bronze	Gold over Nickel	4,000 PCS
C4201M-TCA-H	AWG#18-#24	3.10mm(max)	Copper Alloy	Tin over Nickel	4,000 PCS
C4201M-GCA-H	AWG#18-#24	3.10mm(max)	Copper Alloy	Gold over Nickel	4,000 PCS

Optional Gold plating available but MOQ requested

C4201F-T-HH

4.20mm pitch Crimp Terminal

Reference Informations:

*Used in CJT C4201HF-XP, C4201HF, HFA, HFC-2xXP, C4201HF-2x3P-A/B, C4201HF-2x4P-A/B series Housing

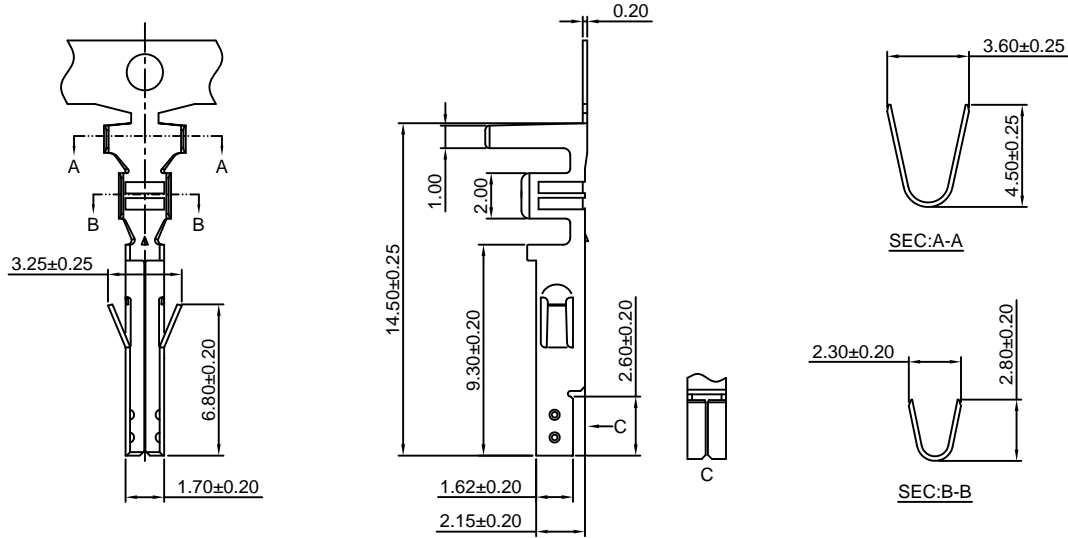

Ordering information & Specifications:

Unit:mm

Part NO.	Wire Range	Insulation O.D.	Material	Finish	Qty/reel
C4201F-TB-HH	AWG#16	3.10mm(max)	Brass	Tin over Nickel	4,500 PCS
C4201F-TP-HH	AWG#16	3.10mm(max)	Phosphor Bronze	Tin over Nickel	4,500 PCS
C4201F-GB-HH	AWG#16	3.10mm(max)	Brass	Gold over Nickel	4,500 PCS
C4201F-GP-HH	AWG#16	3.10mm(max)	Phosphor Bronze	Gold over Nickel	4,500 PCS

Optional Gold plating available but MOQ requested

C4201M-T-HH

4.20mm pitch Crimp Terminal

Reference Informations:

*Used in CJT C4201HM, HMA-XP, C4201HM, HMA, HMB-2xXP, C4201HM-2xXP-A series Housing

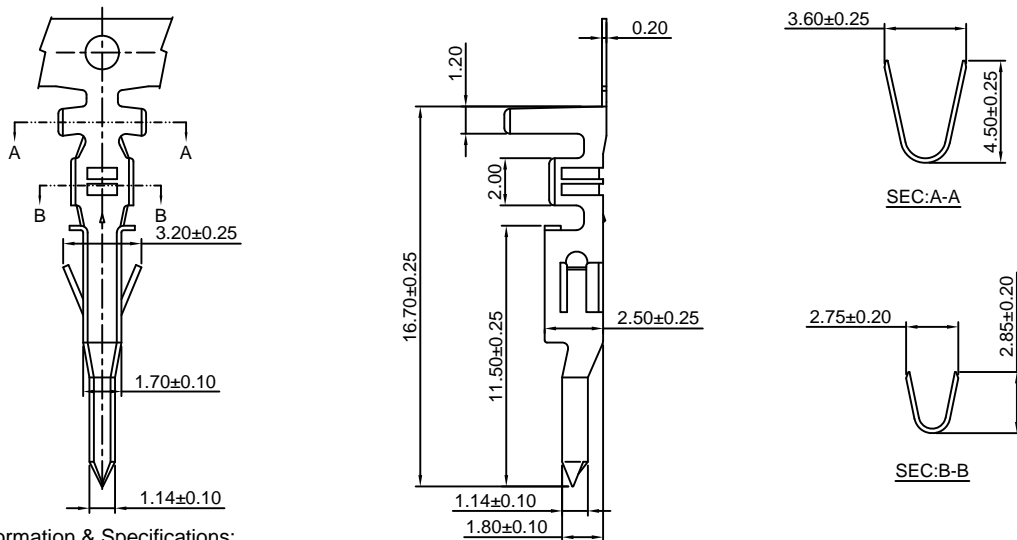

Ordering information & Specifications:

Unit:mm

Part NO.	Wire Range	Insulation O.D.	Material	Finish	Qty/reel
C4201M-TB-HH	AWG#16	3.10mm(max)	Brass	Tin over Nickel	4,000 PCS
C4201M-TP-HH	AWG#16	3.10mm(max)	Phosphor Bronze	Tin over Nickel	4,000 PCS
C4201M-GB-HH	AWG#16	3.10mm(max)	Brass	Gold over Nickel	4,000 PCS
C4201M-GP-HH	AWG#16	3.10mm(max)	Phosphor Bronze	Gold over Nickel	4,000 PCS
C4201M-TCA-HH	AWG#16	3.10mm(max)	Copper Alloy	Tin over Nickel	4,000 PCS
C4201M-GCA-HH	AWG#16	3.10mm(max)	Copper Alloy	Gold over Nickel	4,000 PCS

Optional Gold plating available but MOQ requested

C4201F-TCA-H

4.20mm pitch Crimp Terminal

Reference Informations:

*Used in CJT C4201HF-XP, C4201HF, HFA, HFC-2xXP, C4201HF-2x3P-A/B, C4201HF-2x4P-A/B series Housing

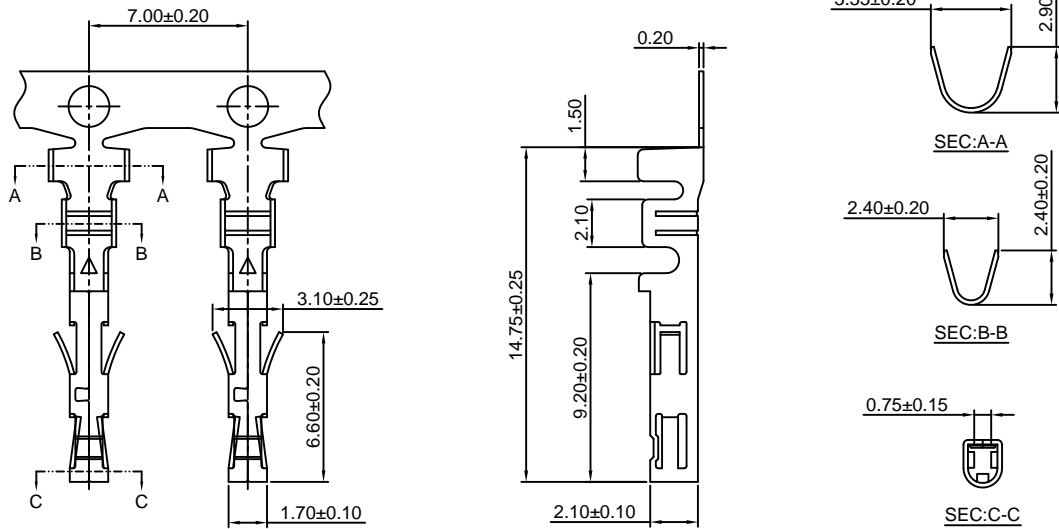

Ordering information & Specifications:

Unit:mm

Part NO.	Wire Range	Insulation O.D.	Material	Finish	Qty/reel
C4201F-TCA-H	AWG#20-#22	2.80mm(max)	Copper Alloy	Tin over Nickel	4,000 PCS
C4201F-GCA-H	AWG#20-#22	2.80mm(max)	Copper Alloy	Gold over Nickel	4,000 PCS

Optional Gold plating available but MOQ requested

C4201F-TCA-HH

4.20mm pitch Crimp Terminal

Reference Informations:

*Used in CJT C4201HF-XP, C4201HF, HFA, HFC-2xXP, C4201HF-2x3P-A/B, C4201HF-2x4P-A/B series Housing

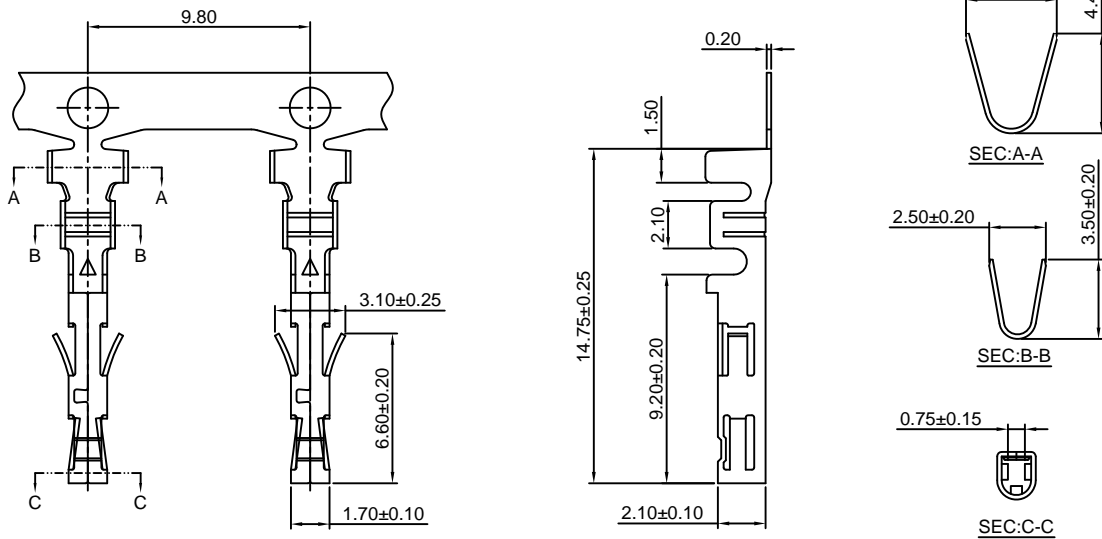

Ordering information & Specifications:

Unit:mm

Part NO.	Wire Range	Insulation O.D.	Material	Finish	Qty/reel
C4201F-TCA-HH	AWG#16	3.10mm(max)	Copper Alloy	Tin over Nickel	5,000 PCS
C4201F-GCA-HH	AWG#16	3.10mm(max)	Copper Alloy	Gold over Nickel	5,000 PCS

Optional Gold plating available but MOQ requested

C4201HMA-XP

4.20mm Pitch Single Row Housing - Without Mounting Ears

Reference Informations:

- *Material: Nylon 66, UL94V-2 or UL94V-0
- *Suitable CJT C4201M-T(-H/-HH) series Terminal
- *Mates with CJT C4201HF-XP series Housing
- *Color: Natural

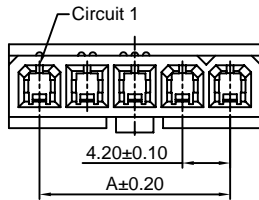

Ordering Information:

C4201HMA-XP - ***
1 2

1. Part No.
2. Material:
(blank): Nylon 66, UL94V-2/Natural
V0: Nylon 66, UL94V-0/White
GWT: Nylon 66, UL94V-0, GWT 750°C

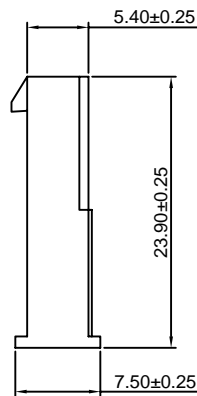
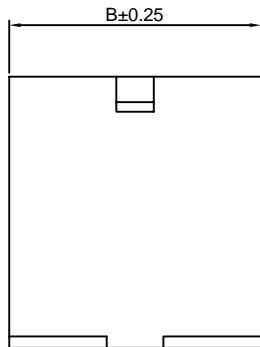
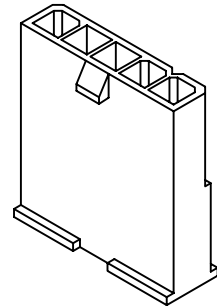

Ordering Information & Dimensions:

PART NO.	Dimensions	
	A	B
2P	4.20	9.60
3P	8.40	13.80
4P	12.60	18.00
5P	16.80	22.20
6P	21.00	26.40
7P	25.20	30.60
8P	29.40	34.80
9P	33.60	39.00
10P	37.80	43.20
11P	42.00	47.40
12P	46.20	51.60

Unit: mm

C4201HF-2xXP

4.20mm pitch Dual Row Housing

Reference Informations:

- *Material: Nylon 66, UL94V-2 or UL94V-0
- *Suitable CJT C4201F-T(-H/-HH), C4201F-TCA-H(HH) series Terminal
- *Mates with CJT C4201HM, HMA-2xXP, C4201HM-2xXP-A series Housing or C4201WV, WR-2xXP, C4201WVA, WVD-2xXP, C4201WVA-F, WVD-F-2xXP, C4201WR-E-2xXP, C4201WR-F-2xXP, C4201WV-S-2xXP series Wafer
- *Color: Natural

Ordering Information:

C4201HF-2xXP - ***
1 2

1. Part No.
2. Material:
(blank): Nylon 66, UL94V-2/Natural
V0: Nylon 66, UL94V-0/White
GWT: Nylon 66, UL94V-0, GWT 750°C

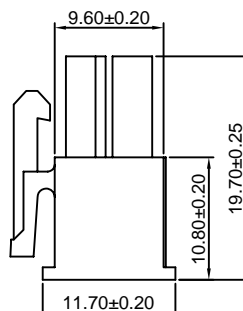
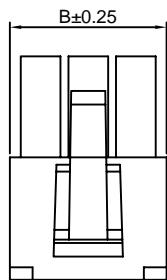
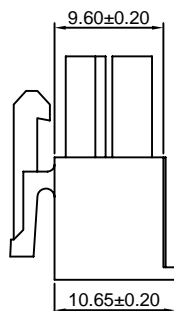
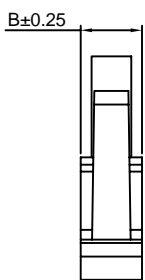
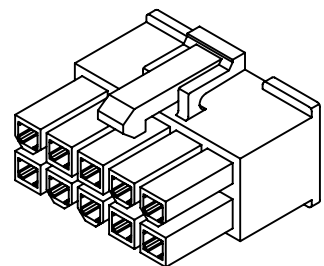
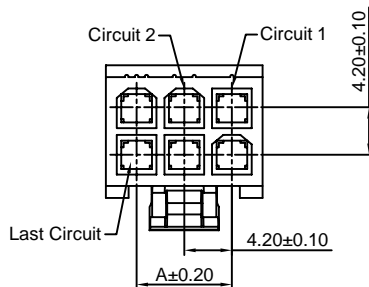
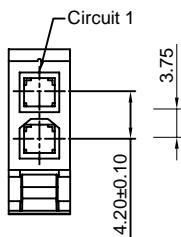

Ordering Information & Dimensions:

PART NO.	Dimensions	
	A	B
2x1P	----	5.40
2x2P	4.20	9.60
2x3P	8.40	13.80
2x4P	12.60	18.00
2x5P	16.80	22.20
2x6P	21.00	26.40
2x7P	25.20	30.60
2x8P	29.40	34.80
2x9P	33.60	39.00
2x10P	37.80	43.20
2x11P	42.00	47.40
2x12P	46.20	51.60

Unit: mm

C4201HFC-2xXP

4.20mm Pitch Dual Row Housing

Reference Informations:

- *Material: Nylon 66, UL94V-2 or UL94V-0
- *Suitable CJT C4201F-T(-H/-HH), C4201F-TCA-H(HH) series Terminal
- *Mates with CJT C4201HM, HMA-2xXP, C4201HM-2xXP-A series Housing or C4201WV, WR-2xXP, C4201WVA, WVD-2xXP, C4201WVA-F, WVD-F-2xXP, C4201WR-E-2xXP, C4201WR-F-2xXP, C4201WV-S-2xXP series Wafer
- *Color: Natural

Ordering Information:
C4201HFC-2xXP - *** - **
 1 2 3

1. Part No.
2. Material:
 (Blank): Nylon 66, UL94V-2
 V0: Nylon 66, UL94V-0
 GWT: Nylon 66, UL94V-0, GWT 750°C
3. Color:
 (Blank): Natural
 WH: White
 BK: Black

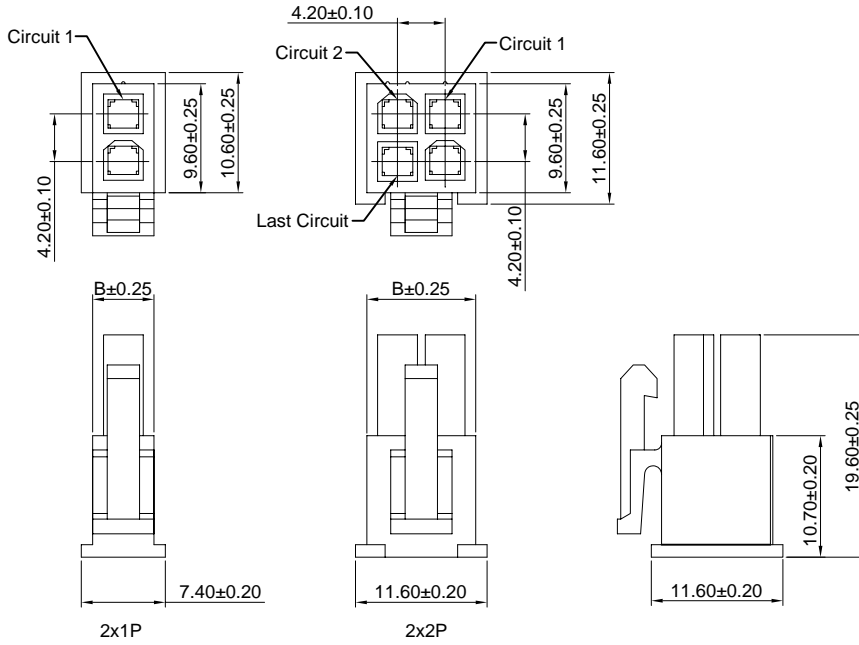

Ordering Information & Dimensions:

PART NO.	Dimensions	
	A	B
2x1P	----	5.40
2x2P	4.20	9.60

Unit: mm

C4201HM-2xXP

4.20mm pitch Dual Row Housing

Reference Informations:

- *Material: Nylon 66, UL94V-2 or UL94V-0
- *Suitable CJT C4201M-T(-H/-HH) series Terminal
- *Mates with CJT C4201HF, HFC-2xXP series Housing
- *Color: Natural

Ordering Information:
C4201HM-2xXP - ***
 1 2

1. Part No.
2. Material:
 (blank): Nylon 66, UL94V-2/Natural
 V0: Nylon 66, UL94V-0/White
 GWT: Nylon 66, UL94V-0, GWT 750°C

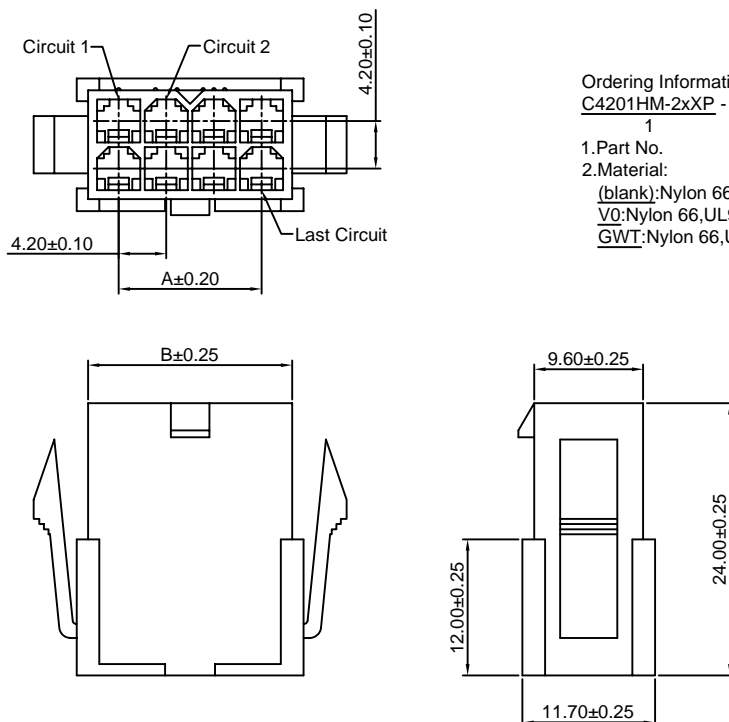
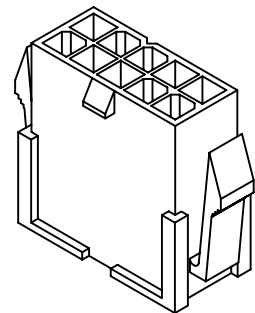

Ordering Information & Dimensions:

PART NO.	Dimensions	
	A	B
2x1P	----	5.40
2x2P	4.20	9.60
2x3P	8.40	13.80
2x4P	12.60	18.00
2x5P	16.80	22.20
2x6P	21.00	26.40
2x7P	25.20	30.60
2x8P	29.40	34.80
2x9P	33.60	39.00
2x10P	37.80	43.20
2x11P	42.00	47.40
2x12P	46.20	51.60

Unit: mm

C4201HM-2xXP-A

4.20mm pitch Dual Row Housing - Without Mounting Ears

Reference Informations:

- *Material: Nylon 66, UL94V-2 or UL94V-0
- *Suitable CJT C4201M-T(-H/-HH) series Terminal
- *Mates with CJT C4201HF, HFC-2xXP series Housing
- *Color: Natural

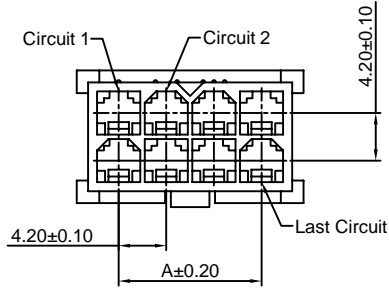

Ordering Information:

C4201HM-2xXP-A - ***
1 2

- Part No.
- Material:
(blank): Nylon 66, UL94V-2/Natural
V0: Nylon 66, UL94V-0/White
GWT: Nylon 66, UL94V-0, GWT 750°C

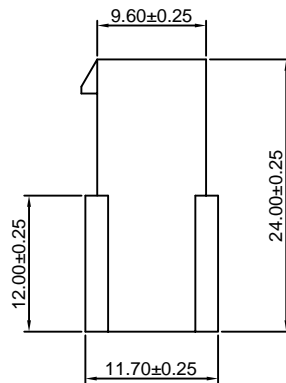
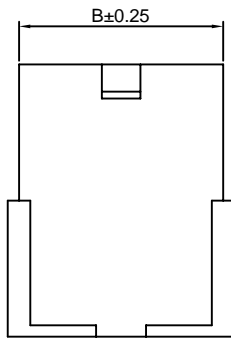
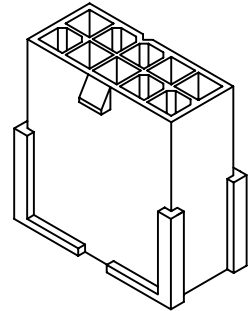

Ordering Information & Dimensions:

PART NO.	Dimensions	
	A	B
2x1P	----	5.40
2x2P	4.20	9.60
2x3P	8.40	13.80
2x4P	12.60	18.00
2x5P	16.80	22.20
2x6P	21.00	26.40
2x7P	25.20	30.60
2x8P	29.40	34.80
2x9P	33.60	39.00
2x10P	37.80	43.20
2x11P	42.00	47.40
2x12P	46.20	51.60

Unit: mm

C4201HMA-2xXP

4.20mm pitch Dual Row Housing - Without Mounting Ears

Reference Informations:

- *Material: Nylon 66, UL94V-2 or UL94V-0
- *Suitable CJT C4201M-T(-H/-HH) series Terminal
- *Mates with CJT C4201HF, HFC-2xXP series Housing
- *Color: Natural

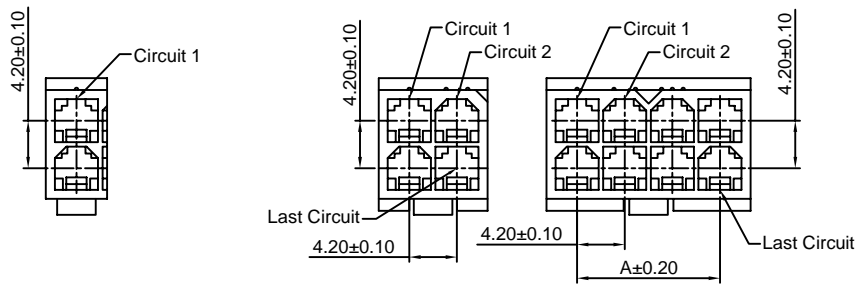

Ordering Information:

C4201HMA-2xXP - ***
1 2

- Part No.
- Material:
(blank): Nylon 66, UL94V-2/Natural
V0: Nylon 66, UL94V-0/White
GWT: Nylon 66, UL94V-0, GWT 750°C

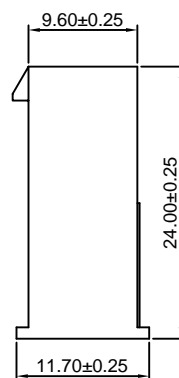
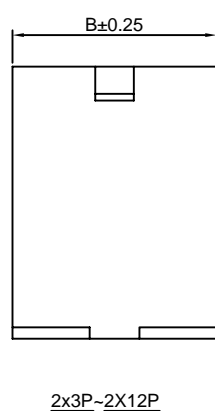
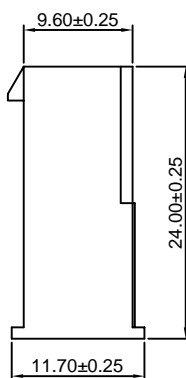
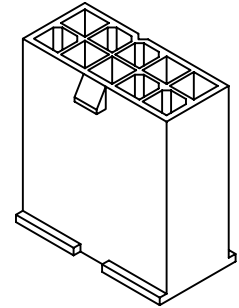

Ordering Information & Dimensions:

PART NO.	Dimensions	
	A	B
2x1P	----	5.40
2x2P	4.20	9.60
2x3P	8.40	13.80
2x4P	12.60	18.00
2x5P	16.80	22.20
2x6P	21.00	26.40
2x7P	25.20	30.60
2x8P	29.40	34.80
2x9P	33.60	39.00
2x10P	37.80	43.20
2x11P	42.00	47.40
2x12P	46.20	51.60

Unit: mm

C4201WV-XP

4.20mm pitch 180° Single Row Wafer - Without Drain Holes

Reference Informations:

- *Material: Pin: Brass/Tin over Nickel
Insulator: Nylon 66, UL94V-2 or UL94V-0
- *Mates with CJT C4201HF-XP series Housing
- *Color: Natural

Ordering Information:

C4201WV-XP - *** - ***
1 2 3

- Part No.
- Material:
(blank): Nylon 66, UL94V-2/Natural
V0: Nylon 66, UL94V-0/White
GWT: Nylon 66, UL94V-0, GWT 750°C
- Pin Material and Finish:
(blank): Brass/Tin over Nickel
G: Brass/Gold-flash
G15: Brass/15µin (0.38µm) MIN. Select Gold (Mating Area)
100µin (2.54µm) MIN. Select Tin
G30: Brass/30µin (0.76µm) MIN. Select Gold (Mating Area)
100µin (2.54µm) MIN. Select Tin
TCA: Copper Alloy/Tin over Nickel
GCA: Copper Alloy/Gold-flash
GCA-G15: Copper Alloy/15µin (0.38µm) MIN. Select Gold (Mating Area)
100µin (2.54µm) MIN. Select Tin
GCA-G30: Copper Alloy/30µin (0.76µm) MIN. Select Gold (Mating Area)
100µin (2.54µm) MIN. Select Tin

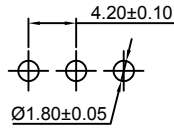
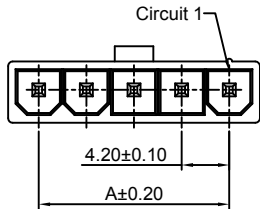
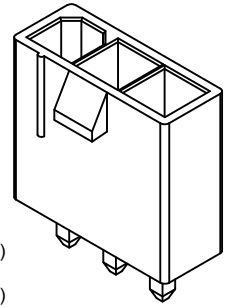

P.C.B LAYOUT

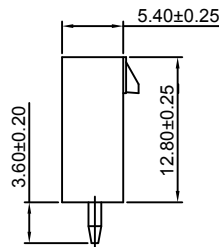
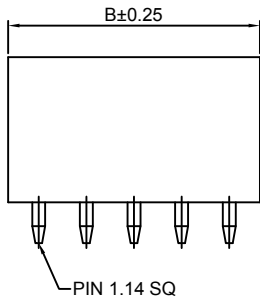

Ordering Information & Dimensions:

PART NO.	Dimensions	
	A	B
2P	4.20	9.60
3P	8.40	13.80
4P	12.60	18.00
5P	16.80	22.20
6P	21.00	26.40
7P	25.20	30.60
8P	29.40	34.80
9P	33.60	39.00
10P	37.80	43.20
11P	42.00	47.40
12P	46.20	51.60

Unit: mm

C4201WVA(D)-XP

4.20mm pitch 180° Single Row Wafer - With Drain Holes

Reference Informations:

- *Material: Pin: Brass/Tin over Nickel
Insulator: Nylon 66, UL94V-2 or UL94V-0
- *Mates with CJT C4201HF-XP series Housing
- *Color: Natural

Ordering Information:

C4201WVA-XP - *** - ***
1 2 3

- Part No.
- Material:
(blank): Nylon 66, UL94V-2/Natural
V0: Nylon 66, UL94V-0/White
GWT: Nylon 66, UL94V-0, GWT 750°C
- Pin Material and Finish:
(blank): Brass/Tin over Nickel
G: Brass/Gold-flash
G15: Brass/15µin (0.38µm) MIN. Select Gold (Mating Area)
100µin (2.54µm) MIN. Select Tin
G30: Brass/30µin (0.76µm) MIN. Select Gold (Mating Area)
100µin (2.54µm) MIN. Select Tin
TCA: Copper Alloy/Tin over Nickel
GCA: Copper Alloy/Gold-flash
GCA-G15: Copper Alloy/15µin (0.38µm) MIN. Select Gold (Mating Area)
100µin (2.54µm) MIN. Select Tin
GCA-G30: Copper Alloy/30µin (0.76µm) MIN. Select Gold (Mating Area)
100µin (2.54µm) MIN. Select Tin

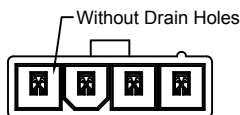
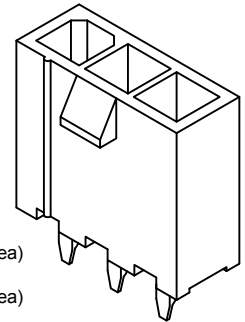

P/N: C4201WVD-XP

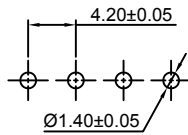
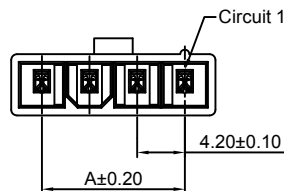

P.C.B LAYOUT

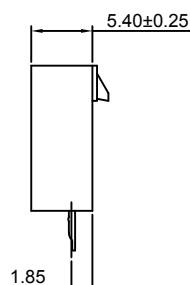
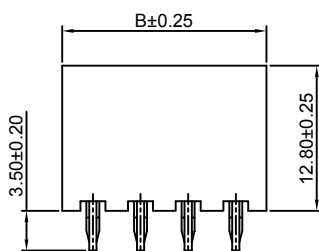

Ordering Information & Dimensions:

PART NO.	Dimensions	
	A	B
2P	4.20	9.60
3P	8.40	13.80
4P	12.60	18.00
5P	16.80	22.20
6P	21.00	26.40
7P	25.20	30.60
8P	29.40	34.80
9P	33.60	39.00
10P	37.80	43.20
11P	42.00	47.40
12P	46.20	51.60

Unit: mm

C4201WVA(D)-F-XP

4.20mm pitch 180° Single Row Wafer With Pegs - With Drain Holes

Reference Informations:

- *Material: Pin: Brass/Tin over Nickel
Insulator: Nylon 66, UL94V-2 or UL94V-0
- *Mates with CJT C4201HF-XP series Housing
- *Color: Natural

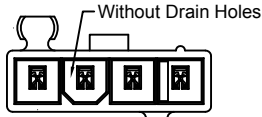

P/N: C4201WVD-F-XP

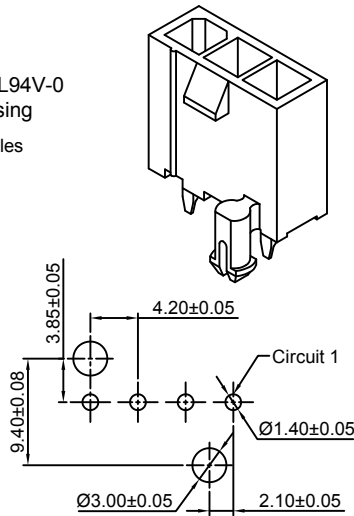
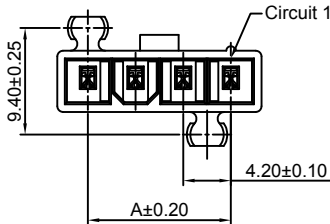

P.C.B LAYOUT

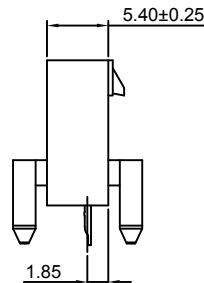
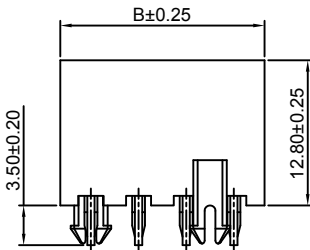

Ordering Information:
C4201WVA-F-XP - *** - ***
1 2 3

- Part No.
- Material:
(blank): Nylon 66, UL94V-2/Natural
V0: Nylon 66, UL94V-0/White
GWT: Nylon 66, UL94V-0, GWT 750°C
- Pin Material and Finish:
(blank): Brass/Tin over Nickel
G: Brass/Gold-flash
G15: Brass/15µm (0.38µm) MIN. Select Gold (Mating Area)
100µm (2.54µm) MIN. Select Tin
G30: Brass/30µm (0.76µm) MIN. Select Gold (Mating Area)
100µm (2.54µm) MIN. Select Tin
TCA: Copper Alloy/Tin over Nickel
GCA: Copper Alloy/Gold-flash
GCA-G15: Copper Alloy/15µm (0.38µm) MIN. Select Gold (Mating Area)
100µm (2.54µm) MIN. Select Tin
GCA-G30: Copper Alloy/30µm (0.76µm) MIN. Select Gold (Mating Area)
100µm (2.54µm) MIN. Select Tin

Ordering Information & Dimensions:

PART NO.	Dimensions	
	A	B
2P	4.20	9.60
3P	8.40	13.80
4P	12.60	18.00
5P	16.80	22.20
6P	21.00	26.40
7P	25.20	30.60
8P	29.40	34.80
9P	33.60	39.00
10P	37.80	43.20
11P	42.00	47.40
12P	46.20	51.60

Unit: mm

C4201WR-XP

4.20mm pitch 90° Single Row Wafer - Without Drain Holes

Reference Informations:

- *Material: Pin: Brass/Tin over Nickel
Insulator: Nylon 66, UL94V-2 or UL94V-0
- *Mates with CJT C4201HF-XP series Housing
- *Color: Natural

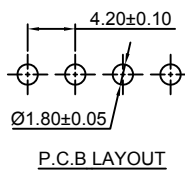
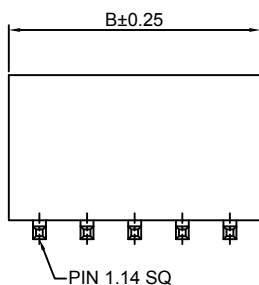
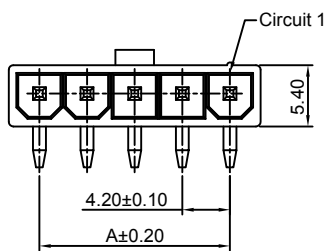

P.C.B LAYOUT

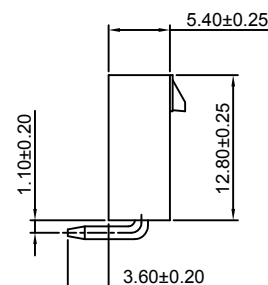

Ordering Information:
C4201WR-XP - *** - ***
1 2 3

- Part No.
- Material:
(blank): Nylon 66, UL94V-2/Natural
V0: Nylon 66, UL94V-0/White
GWT: Nylon 66, UL94V-0, GWT 750°C
- Pin Material and Finish:
(blank): Brass/Tin over Nickel
G: Brass/Gold-flash
G15: Brass/15µm (0.38µm) MIN. Select Gold (Mating Area)
100µm (2.54µm) MIN. Select Tin
G30: Brass/30µm (0.76µm) MIN. Select Gold (Mating Area)
100µm (2.54µm) MIN. Select Tin
TCA: Copper Alloy/Tin over Nickel
GCA: Copper Alloy/Gold-flash
GCA-G15: Copper Alloy/15µm (0.38µm) MIN. Select Gold (Mating Area)
100µm (2.54µm) MIN. Select Tin
GCA-G30: Copper Alloy/30µm (0.76µm) MIN. Select Gold (Mating Area)
100µm (2.54µm) MIN. Select Tin

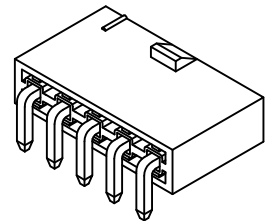

Ordering Information & Dimensions:

PART NO.	Dimensions	
	A	B
2P	4.20	9.60
3P	8.40	13.80
4P	12.60	18.00
5P	16.80	22.20
6P	21.00	26.40
7P	25.20	30.60
8P	29.40	34.80
9P	33.60	39.00
10P	37.80	43.20
11P	42.00	47.40
12P	46.20	51.60

Unit: mm

C4201WR-E-XP

4.20mm pitch 90° Single Row Wafer With Ear - Without Drain Holes

Reference Informations:

- *Material: Pin: Brass/Tin over Nickel
Insulator: Nylon 66, UL94V-2 or UL94V-0
- *Mates with CJT C4201HF-XP series Housing
- *Color: Natural

Ordering Information:
C4201WR-E-XP - *** - ***
1 2 3

- Part No.
- Material:
(blank): Nylon 66, UL94V-2/Natural
V0: Nylon 66, UL94V-0/White
GWT: Nylon 66, UL94V-0, GWT 750°C
- Pin Material and Finish:
(blank): Brass/Tin over Nickel
G: Brass/Gold-flash
G15: Brass/15µm (0.38µm) MIN. Select Gold (Mating Area)
100µm (2.54µm) MIN. Select Tin
G30: Brass/30µm (0.76µm) MIN. Select Gold (Mating Area)
100µm (2.54µm) MIN. Select Tin
TCA: Copper Alloy/Tin over Nickel
GCA: Copper Alloy/Gold-flash
GCA-G15: Copper Alloy/15µm (0.38µm) MIN. Select Gold (Mating Area)
100µm (2.54µm) MIN. Select Tin
GCA-G30: Copper Alloy/30µm (0.76µm) MIN. Select Gold (Mating Area)
100µm (2.54µm) MIN. Select Tin

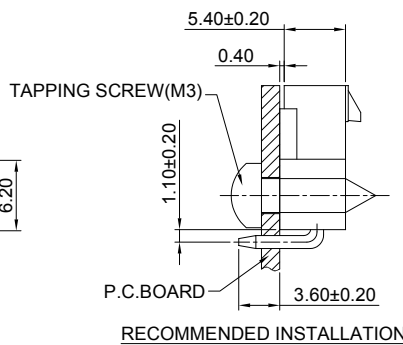
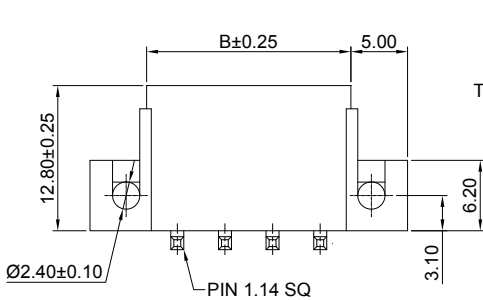
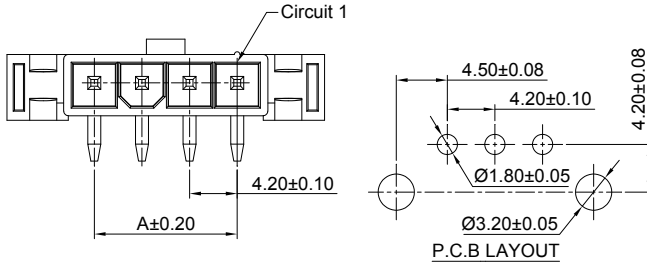
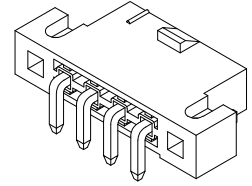

Ordering Information & Dimensions:

PART NO.	Dimensions	
	A	B
2P	4.20	9.60
3P	8.40	13.80
4P	12.60	18.00
5P	16.80	22.20
6P	21.00	26.40
8P	29.40	34.80
9P	33.60	39.00
10P	37.80	43.20
11P	42.00	47.40
12P	46.20	51.60

Unit: mm

C4201WR-F-XP

4.20mm pitch 90° Single Row Wafer With Foot - Without Drain Holes

Reference Informations:

- *Material: Pin: Brass/Tin over Nickel
Insulator: Nylon 66, UL94V-2 or UL94V-0
- *Mates with CJT C4201HF-XP series Housing
- *Color: Natural

Ordering Information:
C4201WR-F-XP - *** - ***
1 2 3

- Part No.
- Material:
(blank): Nylon 66, UL94V-2/Natural
V0: Nylon 66, UL94V-0/White
GWT: Nylon 66, UL94V-0, GWT 750°C
- Pin Material and Finish:
(blank): Brass/Tin over Nickel
G: Brass/Gold-flash
G15: Brass/15µm (0.38µm) MIN. Select Gold (Mating Area)
100µm (2.54µm) MIN. Select Tin
G30: Brass/30µm (0.76µm) MIN. Select Gold (Mating Area)
100µm (2.54µm) MIN. Select Tin
TCA: Copper Alloy/Tin over Nickel
GCA: Copper Alloy/Gold-flash
GCA-G15: Copper Alloy/15µm (0.38µm) MIN. Select Gold (Mating Area)
100µm (2.54µm) MIN. Select Tin
GCA-G30: Copper Alloy/30µm (0.76µm) MIN. Select Gold (Mating Area)
100µm (2.54µm) MIN. Select Tin

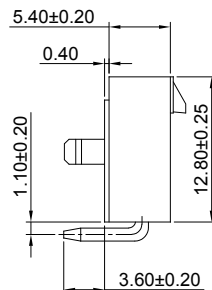
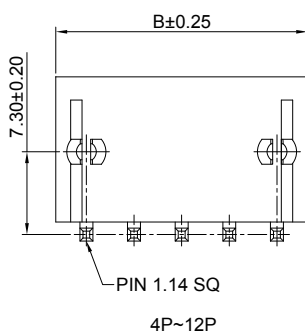
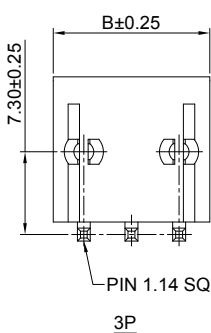
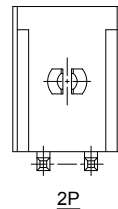
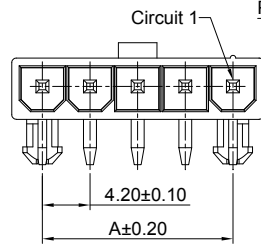
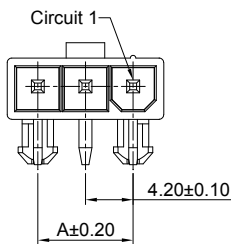
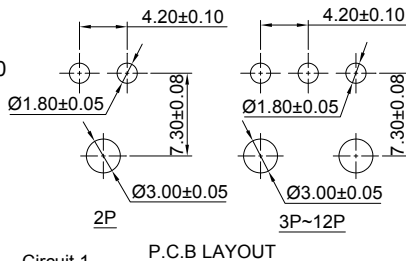

Ordering Information & Dimensions:

PART NO.	Dimensions	
	A	B
2P	4.20	9.60
3P	8.40	13.80
4P	12.60	18.00
5P	16.80	22.20
6P	21.00	26.40
7P	25.20	30.60
8P	29.40	34.80
9P	33.60	39.00
10P	37.80	43.20
11P	42.00	47.40
12P	46.20	51.60

Unit: mm

C4201WV-E1-XP

4.20mm pitch 180° Single Row Wafer With Ear - Without Drain Holes

Reference Informations:

- *Material:Pin:Brass/Tin over Nickel
Insulator:Nylon 66,UL94V-2 or UL94V-0
- *Mates with CJT C4201HF-XP series Housing
- *Color:Natural

Ordering Information:
C4201WV-E1-XP - *** - ***
1 2 3

- Part No.
- Material:
(blank):Nylon 66,UL94V-2/Natural
V0:Nylon 66,UL94V-0/White
GWT:Nylon 66,UL94V-0,GWT 750°C
- Pin Material and Finish:
(blank):Brass/Tin over Nickel
G:Brass/Gold-flash
G15:Brass/15µm (0.38µm) MIN.Select Gold(Mating Area)
100µm (2.54µm) MIN.Select Tin
G30:Brass/30µm (0.76µm) MIN.Select Gold(Mating Area)
100µm (2.54µm) MIN.Select Tin
TCA:Copper Alloy/Tin over Nickel
GCA:Copper Alloy/Gold-flash
GCA-G15:Copper Alloy/15µm (0.38µm) MIN.Select Gold(Mating Area)
100µm (2.54µm) MIN.Select Tin
GCA-G30:Copper Alloy/30µm (0.76µm) MIN.Select Gold(Mating Area)
100µm (2.54µm) MIN.Select Tin

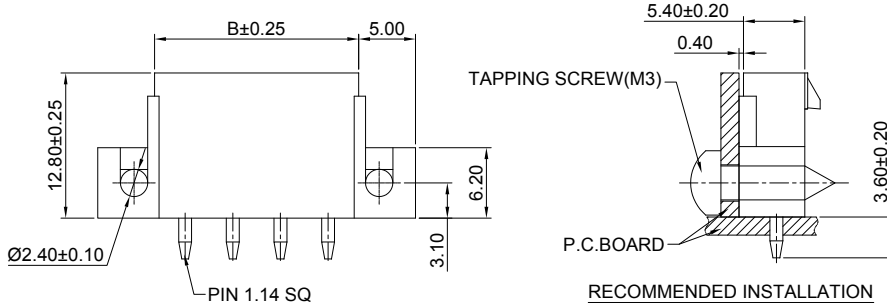
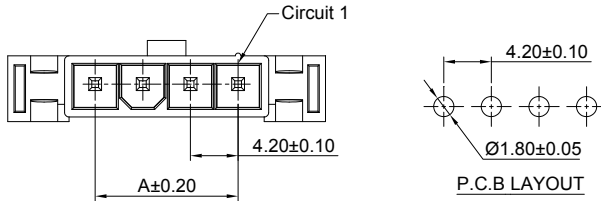

Ordering Information & Dimensions:

PART NO.	Dimensions	
	A	B
3P	8.40	13.80
4P	12.60	18.00
5P	16.80	22.20
6P	21.00	26.40
7P	25.20	30.60
8P	29.40	34.80
9P	33.60	39.00
10P	37.80	43.20
11P	42.00	47.40
12P	46.20	51.60

Unit: mm

C4201WV-F1-XP

4.20mm pitch 180° Single Row Wafer With Foot - Without Drain Holes

Reference Informations:

- *Material:Pin:Brass/Tin over Nickel
Insulator:Nylon 66,UL94V-2 or UL94V-0
- *Mates with CJT C4201HF-XP series Housing
- *Color:Natural

Ordering Information:
C4201WV-F1-XP - *** - ***
1 2 3

- Part No.
- Material:
(blank):Nylon 66,UL94V-2/Natural
V0:Nylon 66,UL94V-0/White
GWT:Nylon 66,UL94V-0,GWT 750°C
- Pin Material and Finish:
(blank):Brass/Tin over Nickel
G:Brass/Gold-flash
G15:Brass/15µm (0.38µm) MIN.Select Gold(Mating Area)
100µm (2.54µm) MIN.Select Tin
G30:Brass/30µm (0.76µm) MIN.Select Gold(Mating Area)
100µm (2.54µm) MIN.Select Tin
TCA:Copper Alloy/Tin over Nickel
GCA:Copper Alloy/Gold-flash
GCA-G15:Copper Alloy/15µm (0.38µm) MIN.Select Gold(Mating Area)
100µm (2.54µm) MIN.Select Tin
GCA-G30:Copper Alloy/30µm (0.76µm) MIN.Select Gold(Mating Area)
100µm (2.54µm) MIN.Select Tin

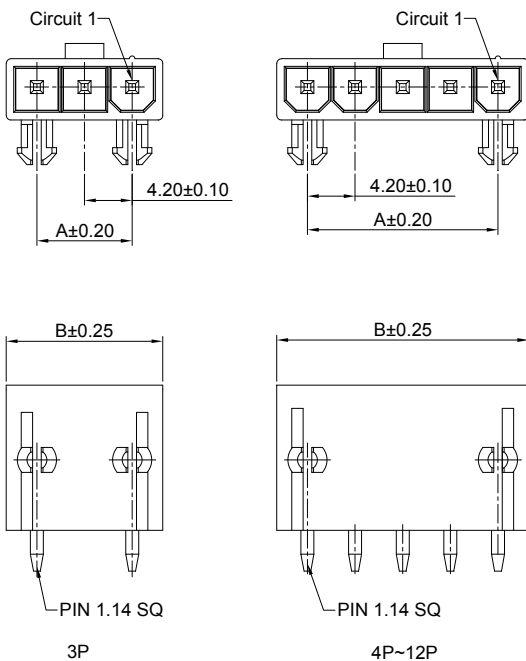
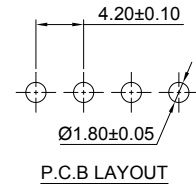

Ordering Information & Dimensions:

PART NO.	Dimensions	
	A	B
3P	8.40	13.80
4P	12.60	18.00
5P	16.80	22.20
6P	21.00	26.40
7P	25.20	30.60
8P	29.40	34.80
9P	33.60	39.00
10P	37.80	43.20
11P	42.00	47.40
12P	46.20	51.60

Unit: mm

C4201WV-2xXP

4.20mm pitch 180° Dual Row Wafer - Without Drain Holes

Reference Informations:

- *Material: Pin: Brass/Tin over Nickel
Insulator: Nylon 66, UL94V-2 or UL94V-0
- *Mates with CJT C4201HF, HFC-2xXP series Housing
- *Color: Natural

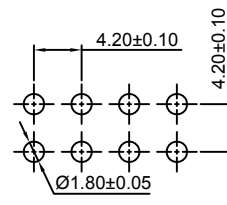
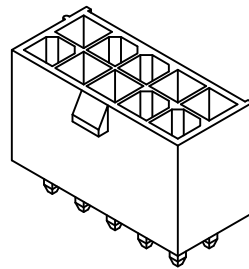
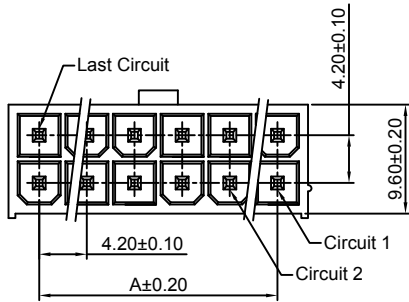

P.C.B LAYOUT

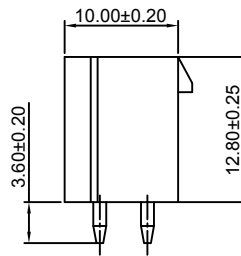
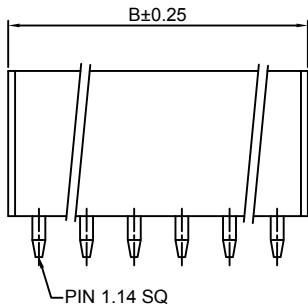

Ordering Information:

C4201WV-2xXP - *** - ***
1 2 3

- Part No.
- Material:
(blank): Nylon 66, UL94V-2/Natural
V0: Nylon 66, UL94V-0/White
GWT: Nylon 66, UL94V-0, GWT 750°C
- Pin Material and Finish:
(blank): Brass/Tin over Nickel
G: Brass/Gold-flash
G15: Brass/15µm (0.38µm) MIN. Select Gold (Mating Area)
100µm (2.54µm) MIN. Select Tin
G30: Brass/30µm (0.76µm) MIN. Select Gold (Mating Area)
100µm (2.54µm) MIN. Select Tin
TCA: Copper Alloy/Tin over Nickel
GCA: Copper Alloy/Gold-flash
GCA-G15: Copper Alloy/15µm (0.38µm) MIN. Select Gold (Mating Area)
100µm (2.54µm) MIN. Select Tin
GCA-G30: Copper Alloy/30µm (0.76µm) MIN. Select Gold (Mating Area)
100µm (2.54µm) MIN. Select Tin

Ordering Information & Dimensions:

PART NO.	Dimensions	
	A	B
2x1P	----	5.40
2x2P	4.20	9.60
2x3P	8.40	13.80
2x4P	12.60	18.00
2x5P	16.80	22.20
2x6P	21.00	26.40
2x7P	25.20	30.60
2x8P	29.40	34.80
2x9P	33.60	39.00
2x10P	37.80	43.20
2x11P	42.00	47.40
2x12P	46.20	51.60

Unit: mm

C4201WVA(D)-2xXP

4.20mm pitch 180° Dual Row Wafer - With Drain Holes

Reference Informations:

- *Material: Pin: Brass/Tin over Nickel
Insulator: Nylon 66, UL94V-2 or UL94V-0
- *Mates with CJT C4201HF, HFC-2xXP series Housing
- *Color: Natural

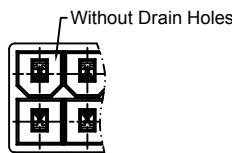
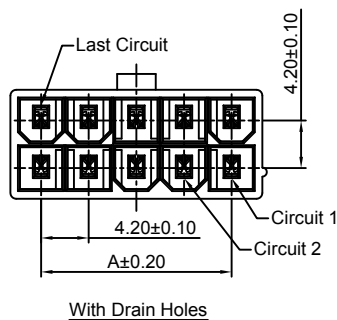

P/N: C4201WVD-2xXP

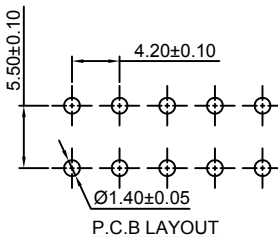

P.C.B LAYOUT

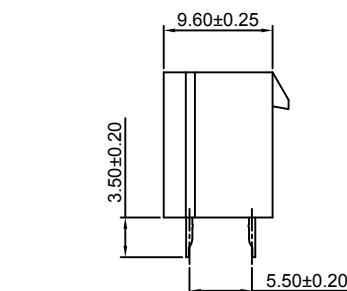
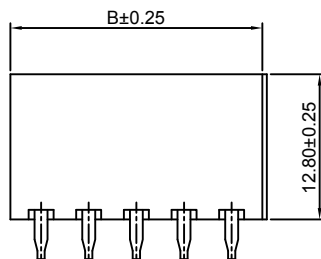

Ordering Information:

C4201WVA(D)-2xXP - *** - ***
1 2 3

- Part No.
- Material:
(blank): Nylon 66, UL94V-2/Natural
V0: Nylon 66, UL94V-0/White
GWT: Nylon 66, UL94V-0, GWT 750°C
- Pin Material and Finish:
(blank): Brass/Tin over Nickel
G: Brass/Gold-flash
G15: Brass/15µm (0.38µm) MIN. Select Gold (Mating Area)
100µm (2.54µm) MIN. Select Tin
G30: Brass/30µm (0.76µm) MIN. Select Gold (Mating Area)
100µm (2.54µm) MIN. Select Tin
TCA: Copper Alloy/Tin over Nickel
GCA: Copper Alloy/Gold-flash
GCA-G15: Copper Alloy/15µm (0.38µm) MIN. Select Gold (Mating Area)
100µm (2.54µm) MIN. Select Tin
GCA-G30: Copper Alloy/30µm (0.76µm) MIN. Select Gold (Mating Area)
100µm (2.54µm) MIN. Select Tin

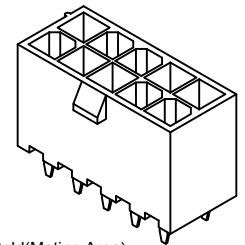

Ordering Information & Dimensions:

PART NO.	Dimensions	
	A	B
2x1P	----	5.40
2x2P	4.20	9.60
2x3P	8.40	13.80
2x4P	12.60	18.00
2x5P	16.80	22.20
2x6P	21.00	26.40
2x7P	25.20	30.60
2x8P	29.40	34.80
2x9P	33.60	39.00
2x10P	37.80	43.20
2x11P	42.00	47.40
2x12P	46.20	51.60

Unit: mm

C4201WVA(D)-F-2xXP

4.20mm pitch 180° Dual Row Wafer With Foot - With Drain Holes

Reference Informations:

- *Material: Pin: Brass/Tin over Nickel
Insulator: Nylon 66, UL94V-2 or UL94V-0
- *Mates with CJT C4201HF, HFC-2xXP series Housing
- *Color: Natural

Ordering Information:
C4201WVA(D)-F-2xXP - *** - ***
1 2 3

- Part No.
- Material:
(blank): Nylon 66, UL94V-2/Natural
V0: Nylon 66, UL94V-0/White
GWT: Nylon 66, UL94V-0, GWT 750°C
- Pin Material and Finish:
(blank): Brass/Tin over Nickel
G: Brass/Gold-flash
G15: Brass/15µm (0.38µm) MIN. Select Gold (Mating Area)
100µm (2.54µm) MIN. Select Tin
G30: Brass/30µm (0.76µm) MIN. Select Gold (Mating Area)
100µm (2.54µm) MIN. Select Tin
TCA: Copper Alloy/Tin over Nickel
GCA: Copper Alloy/Gold-flash
GCA-G15: Copper Alloy/15µm (0.38µm) MIN. Select Gold (Mating Area)
100µm (2.54µm) MIN. Select Tin
GCA-G30: Copper Alloy/30µm (0.76µm) MIN. Select Gold (Mating Area)
100µm (2.54µm) MIN. Select Tin

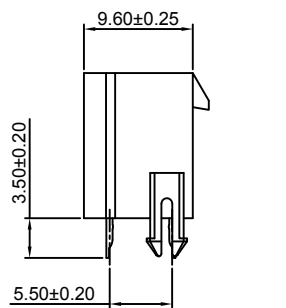
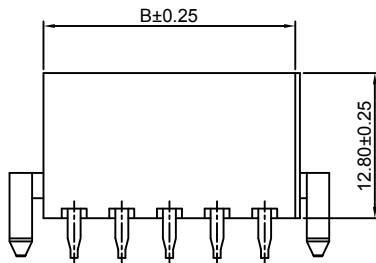
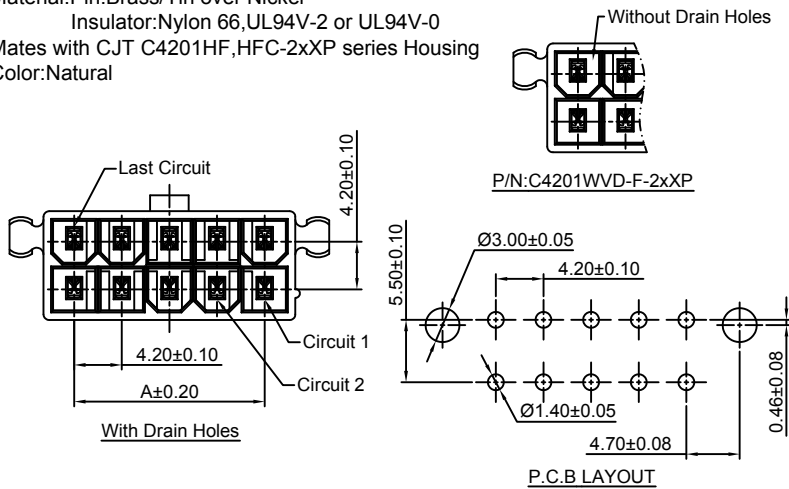
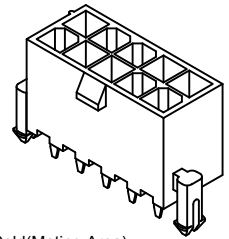

Ordering Information & Dimensions:

PART NO.	Dimensions	
	A	B
2x1P	----	5.40
2x2P	4.20	9.60
2x3P	8.40	13.80
2x4P	12.60	18.00
2x5P	16.80	22.20
2x6P	21.00	26.40
2x7P	25.20	30.60
2x8P	29.40	34.80
2x9P	33.60	39.00
2x10P	37.80	43.20
2x11P	42.00	47.40
2x12P	46.20	51.60

Unit: mm

C4201WR-2xXP

4.20mm pitch 90° Dual Row Wafer - Without Drain Holes

Reference Informations:

- *Material: Pin: Brass/Tin over Nickel
Insulator: Nylon 66, UL94V-2 or UL94V-0
- *Mates with CJT C4201HF, HFC-2xXP series Housing
- *Color: Natural

Ordering Information:
C4201WR-2xXP - *** - ***
1 2 3

- Part No.
- Material:
(blank): Nylon 66, UL94V-2/Natural
V0: Nylon 66, UL94V-0/White
GWT: Nylon 66, UL94V-0, GWT 750°C
- Pin Material and Finish:
(blank): Brass/Tin over Nickel
G: Brass/Gold-flash
G15: Brass/15µm (0.38µm) MIN. Select Gold (Mating Area)
100µm (2.54µm) MIN. Select Tin
G30: Brass/30µm (0.76µm) MIN. Select Gold (Mating Area)
100µm (2.54µm) MIN. Select Tin
TCA: Copper Alloy/Tin over Nickel
GCA: Copper Alloy/Gold-flash
GCA-G15: Copper Alloy/15µm (0.38µm) MIN. Select Gold (Mating Area)
100µm (2.54µm) MIN. Select Tin
GCA-G30: Copper Alloy/30µm (0.76µm) MIN. Select Gold (Mating Area)
100µm (2.54µm) MIN. Select Tin

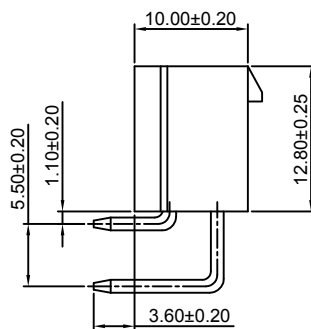
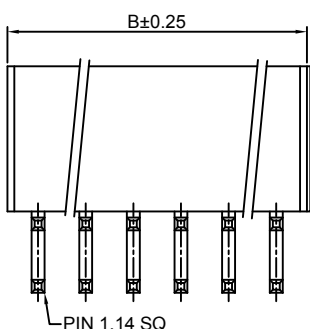
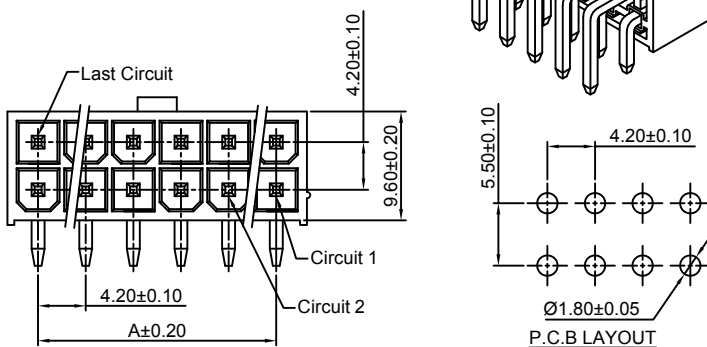
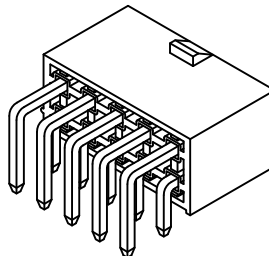

Ordering Information & Dimensions:

PART NO.	Dimensions	
	A	B
2x1P	----	5.40
2x2P	4.20	9.60
2x3P	8.40	13.80
2x4P	12.60	18.00
2x5P	16.80	22.20
2x6P	21.00	26.40
2x7P	25.20	30.60
2x8P	29.40	34.80
2x9P	33.60	39.00
2x10P	37.80	43.20
2x11P	42.00	47.40
2x12P	46.20	51.60

Unit: mm

C4201HF-2x3P-A/B

4.20mm pitch Dual Row Housing - Special Type

Reference Informations:

- *Material: Nylon 66, UL94V-2 or UL94V-0
- *Suitable CJT C4201F-T(-H/-HH), C4201F-TCA-H(HH) series Terminal
- *Mates with CJT C4201HM or C4201WV special type series dual row Housing or Wafer
- *Color: Black

Ordering Information:

C4201HF-2x3P - * - ***

1	2	3

1. Part No.
2. Style:
A: TYPE A
B: TYPE B
3. Material:
(blank): Nylon 66, UL94V-2
V0: Nylon 66, UL94V-0
GWT: Nylon 66, UL94V-0, GWT 750°C

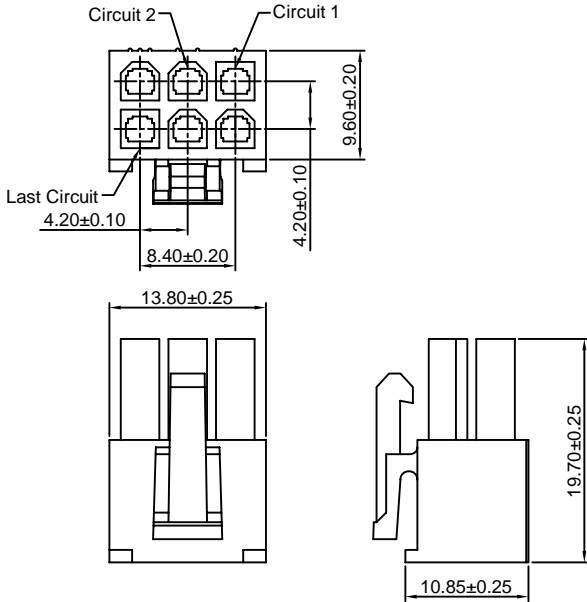
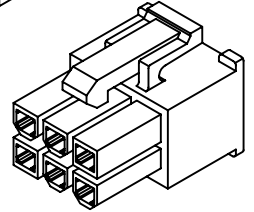
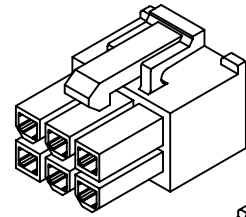

C4201HF-2x3P-A

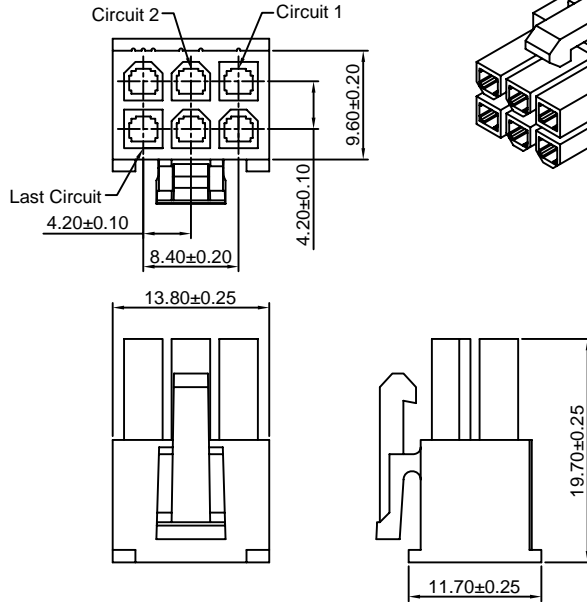

C4201HF-2x3P-B

Unit: mm

C4201HF-2x4P-A/B

4.20mm pitch Dual Row Housing - Special Type

Reference Informations:

- *Material: Nylon 66, UL94V-2 or UL94V-0
- *Suitable CJT C4201F-T(-H/-HH), C4201F-TCA-H(HH) series Terminal
- *Mates with CJT C4201HM or C4201WV special type series dual row Housing or Wafer
- *Color: Black

Ordering Information:

C4201HF-2x4P - * - ***

1	2	3

1. Part No.
2. Style:
A: TYPE A
B: TYPE B
3. Material:
(blank): Nylon 66, UL94V-2
V0: Nylon 66, UL94V-0
GWT: Nylon 66, UL94V-0, GWT 750°C

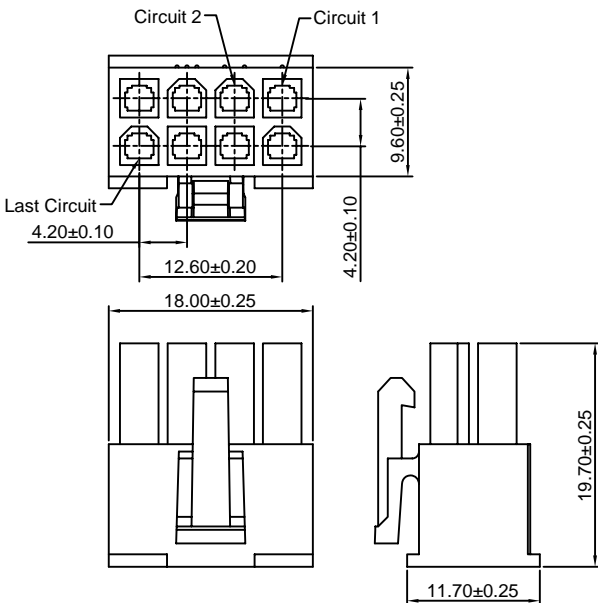
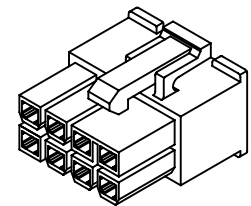
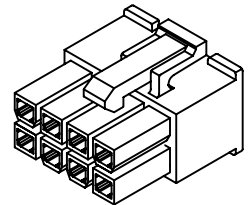

C4201HF-2x4P-A

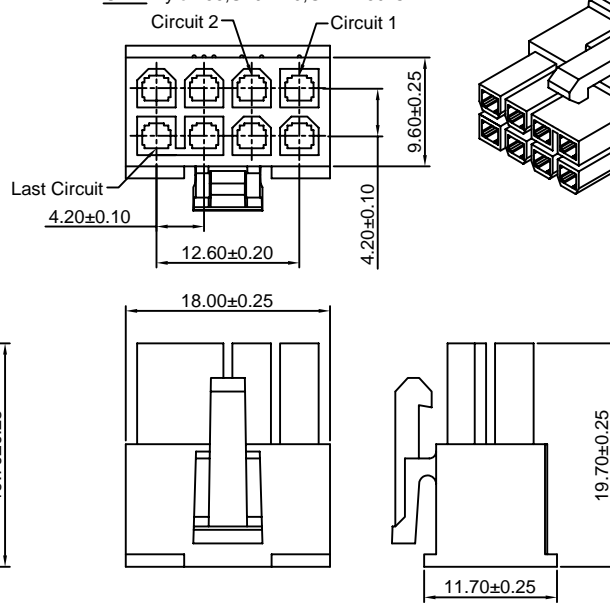

C4201HF-2x4P-B

Unit: mm

C4201WV-2x3P-B/C

4.20mm pitch Dual Row Wafer - Special Type - Without Drain Holes

Reference Informations:

- *Material: Pin: Brass/Tin over Nickel
Insulator: Nylon 66, UL94V-2 or UL94V-0
- *Mates with CJT C4201HF-2x3P-A/B special type series dual row Housing
- *Color: Black

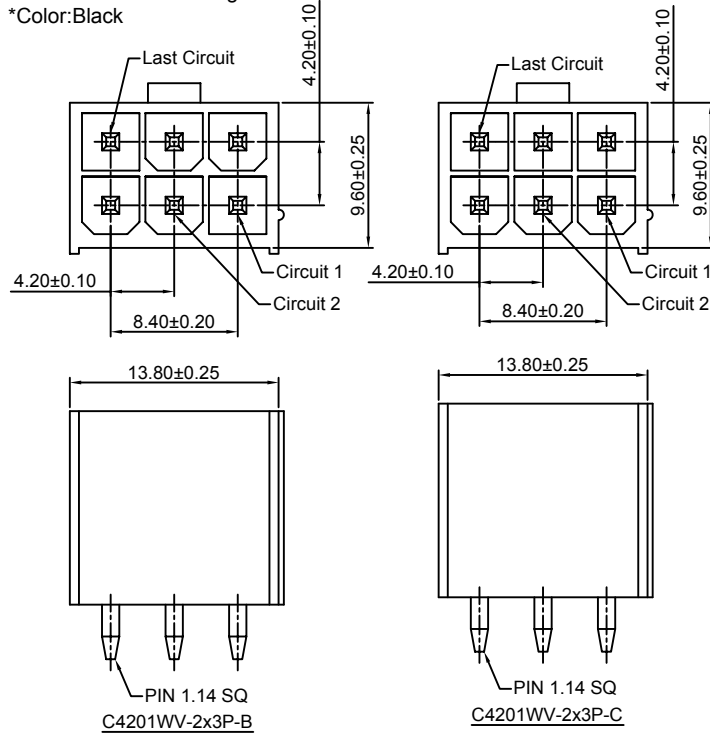

Ordering Information:

C4201WV-2x3P - * - *** - ***
1 2 3 4

- Part No.
- Style:
B: TYPE B
C: TYPE C
- Material:
(blank): Nylon 66, UL94V-2
V0: Nylon 66, UL94V-0
GWT: Nylon 66, UL94V-0, GWT 750°C
- Pin Material and Finish:
(blank): Brass/Tin over Nickel
G: Brass/Gold-flash
G15: Brass/15µin (0.38µm) MIN. Select Gold (Mating Area)
100µin (2.54µm) MIN. Select Tin
G30: Brass/30µin (0.76µm) MIN. Select Gold (Mating Area)
100µin (2.54µm) MIN. Select Tin
TCA: Copper Alloy/Tin over Nickel
GCA: Copper Alloy/Gold-flash
GCA-G15: Copper Alloy/15µin (0.38µm) MIN. Select Gold (Mating Area)
100µin (2.54µm) MIN. Select Tin
GCA-G30: Copper Alloy/30µin (0.76µm) MIN. Select Gold (Mating Area)
100µin (2.54µm) MIN. Select Tin

Unit: mm

C4201WV-2x4P-A/B

4.20mm pitch Dual Row Wafer - Special Type - Without Drain Holes

Reference Informations:

- *Material: Pin: Brass/Tin over Nickel
Insulator: Nylon 66, UL94V-2 or UL94V-0
- *Mates with CJT C4201HF-2x4P-A/B special type series dual row Housing
- *Color: Black

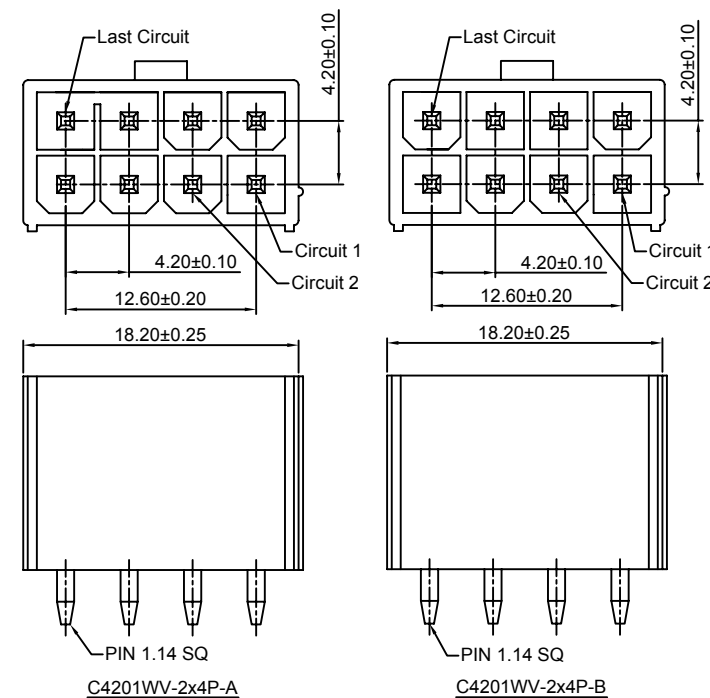

Ordering Information:

C4201WV-2x4P - * - *** - ***
1 2 3 4

- Part No.
- Style:
A: TYPE A
B: TYPE B
- Material:
(blank): Nylon 66, UL94V-2
V0: Nylon 66, UL94V-0
GWT: Nylon 66, UL94V-0, GWT 750°C
- Pin Material and Finish:
(blank): Brass/Tin over Nickel
G: Brass/Gold-flash
G15: Brass/15µin (0.38µm) MIN. Select Gold (Mating Area)
100µin (2.54µm) MIN. Select Tin
G30: Brass/30µin (0.76µm) MIN. Select Gold (Mating Area)
100µin (2.54µm) MIN. Select Tin
TCA: Copper Alloy/Tin over Nickel
GCA: Copper Alloy/Gold-flash
GCA-G15: Copper Alloy/15µin (0.38µm) MIN. Select Gold (Mating Area)
100µin (2.54µm) MIN. Select Tin
GCA-G30: Copper Alloy/30µin (0.76µm) MIN. Select Gold (Mating Area)
100µin (2.54µm) MIN. Select Tin

Unit: mm

C4201WR-F-2x3P-A

4.20mm pitch 90° Dual Row Wafer With Foot - Special TYPE - Without Drain Holes

Reference Informations:

- *Material: Pin: Brass/Tin over Nickel
Insulator: Nylon 66, UL94V-2 or UL94V-0
- *Mates with CJT C4201HF-2x3P-B special type series dual row Housing
- *Color: Black

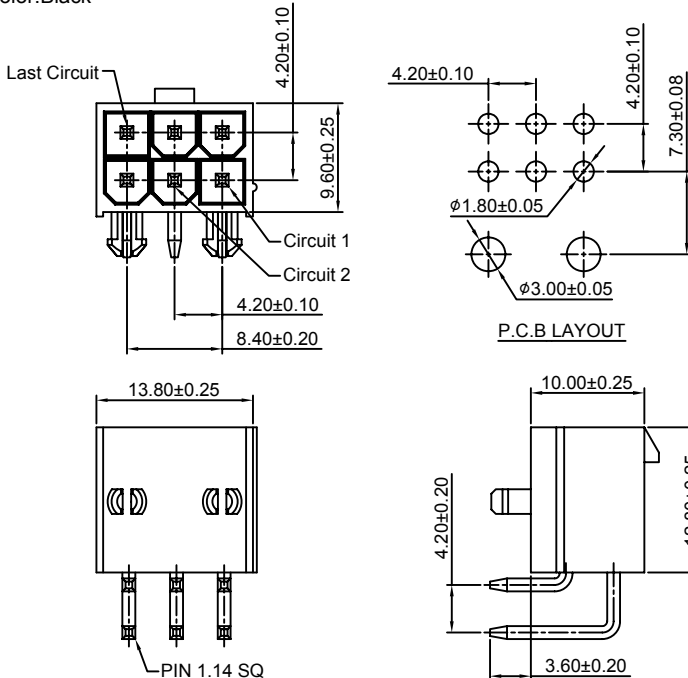
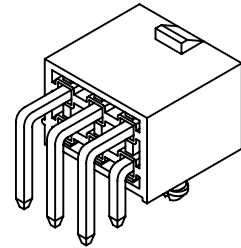

Ordering Information:

C4201WR-F-2x3P-A - *** - ***
1 2 3

- Part No.
- Material:
(blank): Nylon 66, UL94V-2
V0: Nylon 66, UL94V-0
GWT: Nylon 66, UL94V-0, GWT 750°C
- Pin Material and Finish:
(blank): Brass/Tin over Nickel
G: Brass/Gold-flash
G15: Brass/15µm (0.38µm) MIN. Select Gold (Mating Area)
100µm (2.54µm) MIN. Select Tin
G30: Brass/30µm (0.76µm) MIN. Select Gold (Mating Area)
100µm (2.54µm) MIN. Select Tin
TCA: Copper Alloy/Tin over Nickel
GCA: Copper Alloy/Gold-flash
GCA-G15: Copper Alloy/15µm (0.38µm) MIN. Select Gold (Mating Area)
100µm (2.54µm) MIN. Select Tin
GCA-G30: Copper Alloy/30µm (0.76µm) MIN. Select Gold (Mating Area)
100µm (2.54µm) MIN. Select Tin

Unit: mm

C4201HFA-2xXP

4.20mm Pitch Dual Row With Panel Mount Ears Housing

Reference Informations:

- *Material: Nylon 66, UL94V-2 or UL94V-0
- *Suitable CJT C4201F-T(-H/-HH) series Terminal
- *Mates with CJT C4201HMB-2xXP series Housing or C4201WVA-F1, WR-F1-2xXP, C4201WVB, WRB-2xXP, C4201WRB-F-2xXP series Wafer
- *Color: Natural

Ordering Information:

C4201HFA-2xXP - ***
1 2

- Part No.
- Material:
(blank): Nylon 66, UL94V-2/Natural
V0: Nylon 66, UL94V-0/White
GWT: Nylon 66, UL94V-0, GWT 750°C

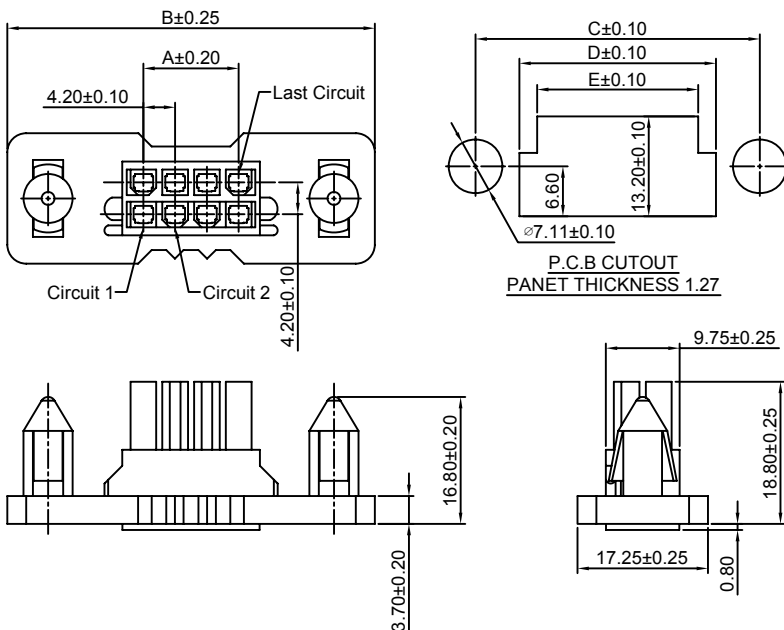
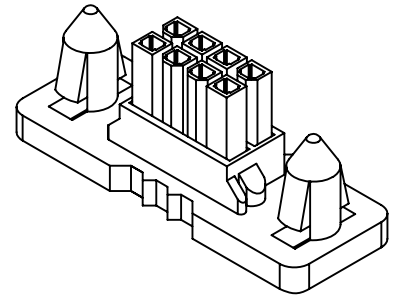

Ordering Information & Dimensions:

PART NO.	Dimensions				
	A	B	C	D	E
2x1P	---	36.00	25.00	13.40	8.70
2x2P	4.20	40.20	29.20	17.60	12.90
2x3P	8.40	44.40	33.40	21.80	17.10
2x4P	12.60	48.60	37.60	26.00	21.30
2x5P	16.80	52.80	41.80	30.20	25.50
2x6P	21.00	57.00	46.00	34.40	29.70
2x7P	25.20	61.20	50.20	38.60	33.90
2x8P	29.40	65.40	54.40	42.80	38.10
2x9P	33.60	69.60	58.60	47.00	42.30
2x10P	37.80	73.80	62.80	51.20	46.50
2x11P	42.00	78.00	67.00	55.40	50.70
2x12P	46.20	82.20	71.20	59.60	54.90
2x18P	71.40	107.40	96.40	81.50	76.78

Unit: mm

C4201HV-2xXP

4.20mm Pitch Vertical Dual Row Receptacle Header

Reference Informations:

- *Material: Pin: Phosphor Bronze/Tin over Nickel
Insulator: Nylon 66, UL94V-2 or UL94V-0
- *Mates with CJT C4201HMB-2xXP series Housing or C4201WVA-F1, WR-F1-2xXP, C4201WVB, WRB-2xXP, C4201WRB-F-2xXP series Wafer
- *Color: Natural

- Ordering Information:
C4201HV-2xXP - *** - **
1. Part No.
2. Material:
(blank): Nylon 66, UL94V-2/Natural
V0: Nylon 66, UL94V-0/White
GWT: Nylon 66, UL94V-0, GWT 750°C
3. Pin Material and Finish:
(blank): Brass/Tin over Nickel
G: Brass/Gold-flash
G15: Brass/15µin (0.38µm) MIN. Select Gold (Mating Area)
100µin (2.54µm) MIN. Select Tin
G30: Brass/30µin (0.76µm) MIN. Select Gold (Mating Area)
100µin (2.54µm) MIN. Select Tin
TCA: Copper Alloy/Tin over Nickel
GCA: Copper Alloy/Gold-flash
GCA-G15: Copper Alloy/15µin (0.38µm) MIN. Select Gold (Mating Area)
100µin (2.54µm) MIN. Select Tin
GCA-G30: Copper Alloy/30µin (0.76µm) MIN. Select Gold (Mating Area)
100µin (2.54µm) MIN. Select Tin

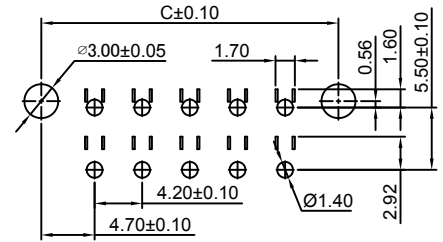

P.C.B LAYOUT: Component Side
Recommended PCB Thickness 1.78MMX

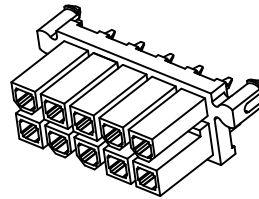
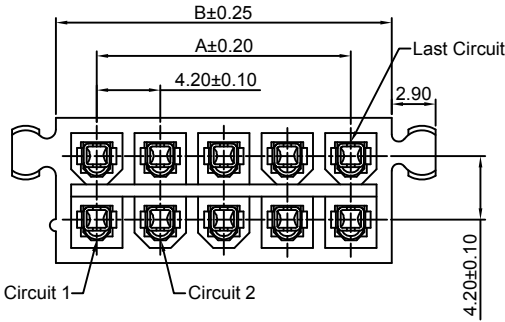

Ordering Information & Dimensions:

PART NO.	Dimensions		
	A	B	C
2x1P	----	5.40	9.40
2x2P	4.20	9.60	13.60
2x3P	8.40	13.80	17.80
2x4P	12.60	18.00	22.00
2x5P	16.80	22.20	26.20
2x6P	21.00	26.40	30.40
2x7P	25.20	30.60	34.60
2x8P	29.40	34.80	38.80
2x9P	33.60	39.00	43.00
2x10P	37.80	43.20	47.20
2x11P	42.00	47.40	51.40
2x12P	46.20	51.60	55.60
2x18P	71.40	76.80	80.80

Unit: mm

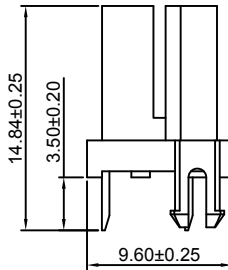
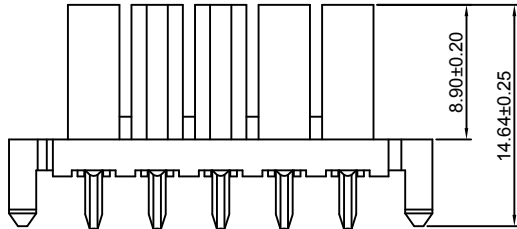

C4201HMB-2xXP

4.20mm Pitch Dual Row Housing With Panel Mount Ears

Reference Informations:

- *Material: Nylon 66, UL94V-2 or UL94V-0
- *Suitable CJT C4201M-T(-H/-HH) series Terminal
- *Mates with CJT C4201HFA-2xXP series Housing or C4201HV-2xXP series Header
- *Color: Natural

- Ordering Information:
C4201HMB-2xXP - ***
1. Part No.
2. Material:
(blank): Nylon 66, UL94V-2/Natural
V0: Nylon 66, UL94V-0/White
GWT: Nylon 66, UL94V-0, GWT 750°C

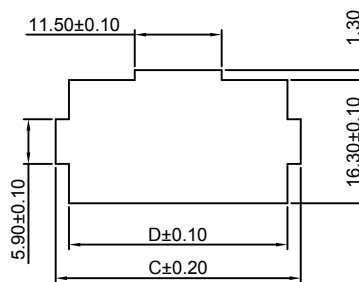
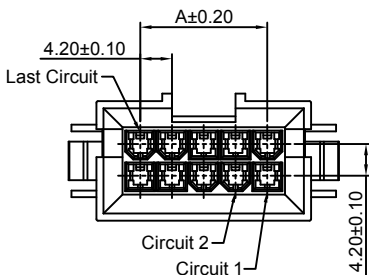
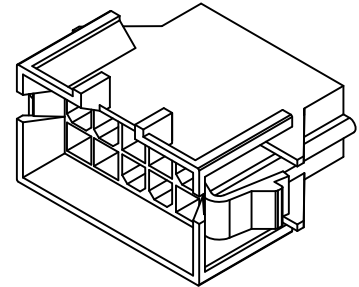

RECOMMENDED P.C.B CUTOUT
PANET THICKNESS 1.60

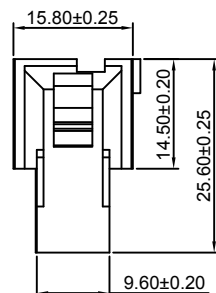
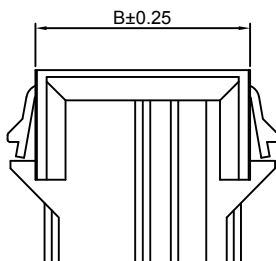

Ordering Information & Dimensions:

PART NO.	Dimensions			
	A	B	C	D
2x1P	----	11.60	15.60	12.10
2x2P	4.20	15.80	19.80	16.30
2x3P	8.40	20.00	24.00	20.50
2x4P	12.60	24.20	28.20	24.70
2x5P	16.80	28.40	32.40	28.90
2x6P	21.00	32.60	36.60	33.10
2x7P	25.20	36.80	40.80	37.30
2x8P	29.40	41.00	45.00	41.50
2x9P	33.60	45.20	49.20	45.70
2x10P	37.80	49.40	53.40	49.90
2x11P	42.00	53.60	57.60	54.10
2x12P	46.20	57.80	61.80	58.30
2x18P	71.40	83.00	87.00	83.50

Unit: mm

C4201WVA(D)-F1-2xXP

4.20mm pitch 180° Dual Row Wafer With Foot - With Drain Holes

Reference Informations:

- *Material: Pin: Brass/Tin over Nickel
Insulator: Nylon 66, UL94V-2 or UL94V-0
- *Mates with CJT C4201HFA-2xXP series Housing or C4201HV-2xXP series Header
- *Color: Natural

Ordering Information:
C4201WVA(D)-F1-2xXP - *** - ***
1 2 3

- Part No.
- Material:
(blank): Nylon 66, UL94V-2/Natural
V0: Nylon 66, UL94V-0/White
GWT: Nylon 66, UL94V-0, GWT 750°C
- Pin Material and Finish:
(blank): Brass/Tin over Nickel
G: Brass/Gold-flash
G15: Brass/15µin (0.38µm) MIN. Select Gold (Mating Area)
100µin (2.54µm) MIN. Select Tin
G30: Brass/30µin (0.76µm) MIN. Select Gold (Mating Area)
100µin (2.54µm) MIN. Select Tin
TCA: Copper Alloy/Tin over Nickel
GCA: Copper Alloy/Gold-flash
GCA-G15: Copper Alloy/15µin (0.38µm) MIN. Select Gold (Mating Area)
100µin (2.54µm) MIN. Select Tin
GCA-G30: Copper Alloy/30µin (0.76µm) MIN. Select Gold (Mating Area)
100µin (2.54µm) MIN. Select Tin

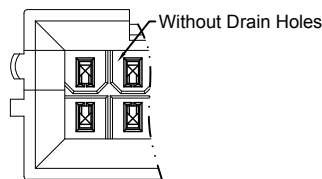
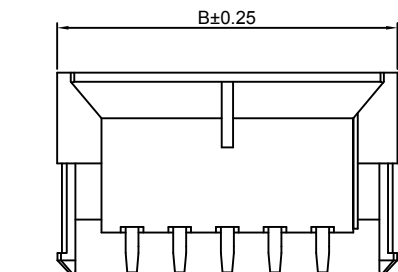
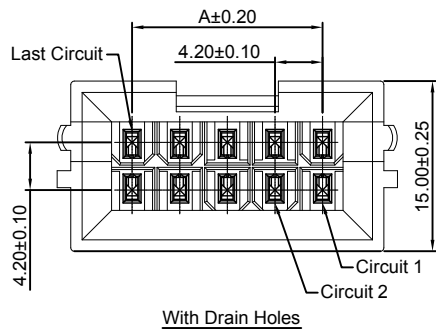

P/N: C4201WVD-F1-2xXP

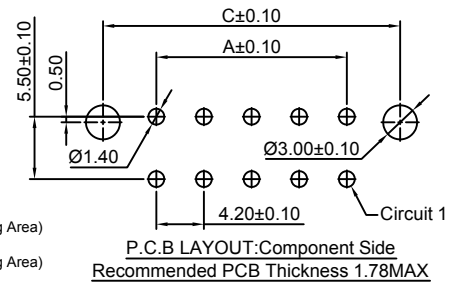
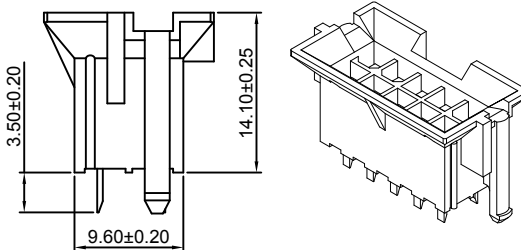

Ordering Information & Dimensions:

PART NO.	Dimensions		
	A	B	C
2x1P	----	13.20	9.40
2x2P	4.20	17.40	13.60
2x3P	8.40	21.60	17.80
2x4P	12.60	25.80	22.00
2x5P	16.80	30.00	26.20
2x6P	21.00	34.20	30.40
2x7P	25.20	38.40	34.60
2x8P	29.40	42.60	38.80
2x9P	33.60	46.80	43.00
2x10P	37.80	51.00	47.20
2x11P	42.00	55.20	51.40
2x12P	46.20	59.40	55.60
2x18P	71.40	84.60	80.80

Unit: mm

C4201WR-F1-2xXP

4.20mm pitch 90° Dual Row Wafer With Foot

Reference Informations:

- *Material: Pin: Brass/Tin over Nickel
Insulator: Nylon 66, UL94V-2 or UL94V-0
- *Mates with CJT C4201HFA-2xXP series Housing or C4201HV-2xXP series Header
- *Color: Natural

Ordering Information:
C4201WR-F1-2xXP - *** - ***
1 2 3

- Part No.
- Material:
(blank): Nylon 66, UL94V-2/Natural
V0: Nylon 66, UL94V-0/White
GWT: Nylon 66, UL94V-0, GWT 750°C
- Finish:
(blank): Tin over Nickel
G: Gold-flash
G15: 15µin (0.38µm) MIN. Select Gold (Mating Area)
100µin (2.54µm) MIN. Select Tin
G30: 30µin (0.76µm) MIN. Select Gold (Mating Area)
100µin (2.54µm) MIN. Select Tin

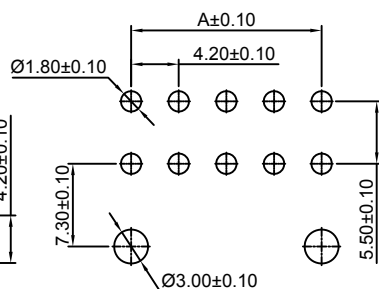
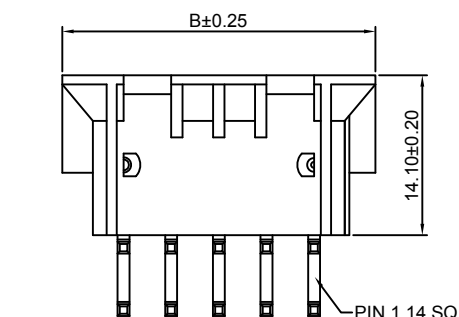
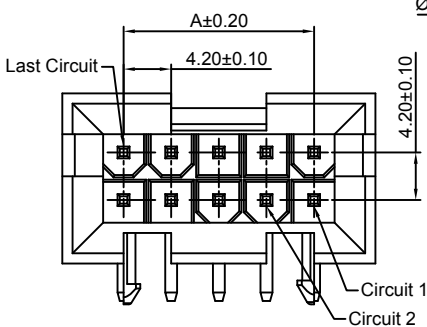

P.C.B LAYOUT: Component Side
Recommended PCB Thickness 1.78MAX

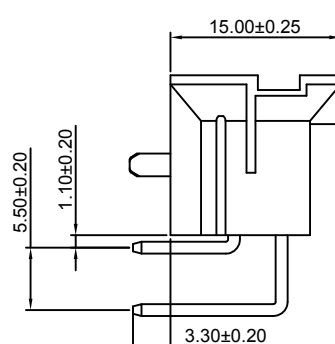

Ordering Information & Dimensions:

PART NO.	Dimensions	
	A	B
2x1P	----	10.80
2x2P	4.20	15.00
2x3P	8.40	19.20
2x4P	12.60	23.40
2x5P	16.80	27.60
2x6P	21.00	31.80
2x7P	25.20	36.00
2x8P	29.40	40.20
2x9P	33.60	44.40
2x10P	37.80	48.60
2x11P	42.00	52.80
2x12P	46.20	57.00
2x18P	71.40	82.20

Unit: mm

C4201WVB-2xXP

4.20mm pitch 180° Dual Row Wafer With Foot

Reference Informations:

- *Material: Pin: Phosphor Bronze/Tin over Nickel
Insulator: Nylon 66, UL94V-0
- *Mates with CJT C4201HFA-2xXP series Housing or C4201HV-2xXP series Header
- *Color: Black

Ordering Information:

C4201WVB-2xXP - *** - ***
1 2 3

1. Part No.
2. Material:
(blank): Nylon 66, UL94V-0
GWT: Nylon 66, UL94V-0, GWT 750°C
3. Finish:
(blank): Tin over Nickel
G: Gold-flash
G15: 15µm (0.38µm) MIN. Select Gold (Mating Area)
100µm (2.54µm) MIN. Select Tin
G30: 30µm (0.76µm) MIN. Select Gold (Mating Area)
100µm (2.54µm) MIN. Select Tin

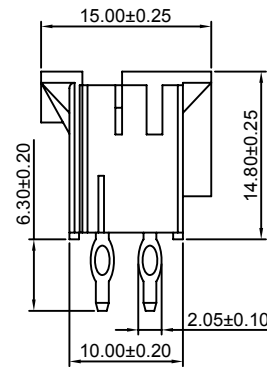
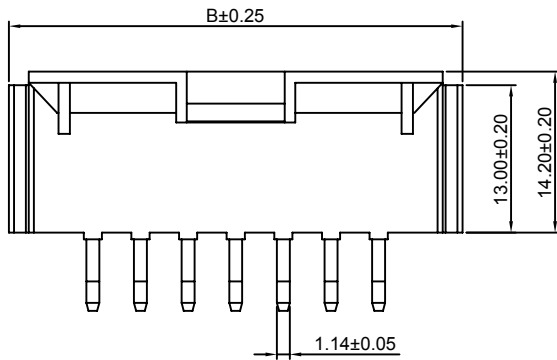
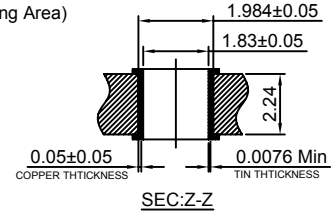
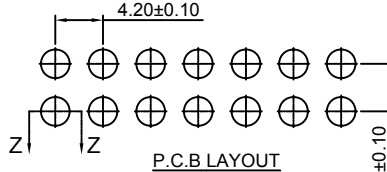
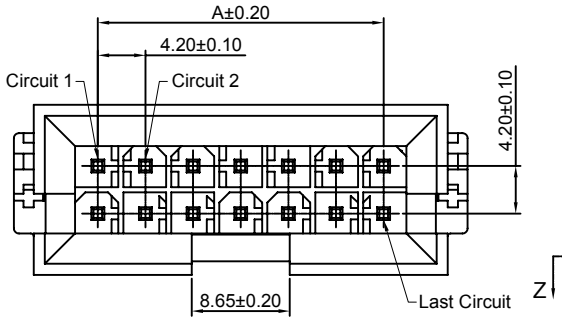
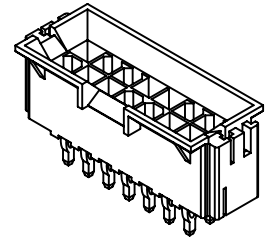

Ordering Information & Dimensions:

PART NO.	Dimensions	
	A	B
2x2P	4.20	19.00
2x3P	8.40	23.20
2x4P	12.60	27.40
2x5P	16.80	31.60
2x6P	21.00	35.80
2x7P	25.20	40.00
2x8P	29.40	44.20
2x9P	33.60	48.40
2x10P	37.80	52.60
2x11P	42.00	56.80
2x12P	46.20	61.00

Unit: mm

C4201WRB-2xXP

4.20mm pitch 90° Dual Row Wafer

Reference Informations:

- *Material: Pin: Brass
Pin Finish: See The ①
Insulator: Nylon 66, UL94V-0
- *Mates with CJT C4201HFA-2xXP series Housing or C4201HV-2xXP series Header
- *Color: Black

①

Ordering Information:

C4201WRB-2xXP - *** - ***
1 2 3

1. Part No.
2. Material:
(blank): Nylon 66, UL94V-0
GWT: Nylon 66, UL94V-0, GWT 750°C
3. Finish:
(blank): Tin over Nickel
G: Gold-flash
G15: 15µm (0.38µm) MIN. Select Gold (Mating Area)
100µm (2.54µm) MIN. Select Tin
G30: 30µm (0.76µm) MIN. Select Gold (Mating Area)
100µm (2.54µm) MIN. Select Tin

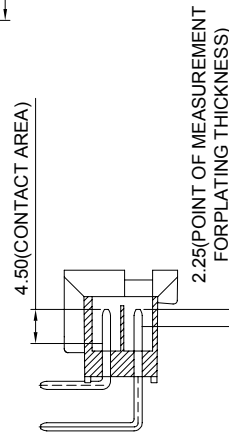
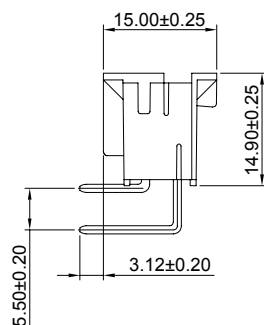
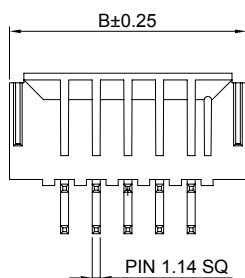
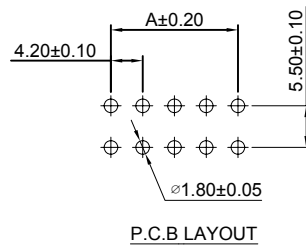
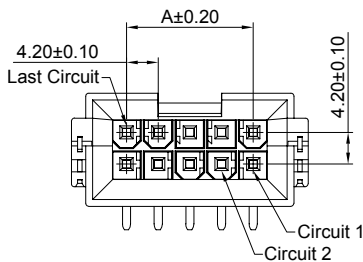
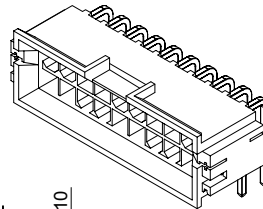

Ordering Information & Dimensions:

PART NO.	Dimensions	
	A	B
2x2P	4.20	18.81
2x3P	8.40	23.01
2x4P	12.60	27.21
2x5P	16.80	31.41
2x6P	21.00	35.61
2x7P	25.20	39.81
2x8P	29.40	44.01
2x9P	33.60	48.21
2x10P	37.80	52.41
2x11P	42.00	56.61
2x12P	46.20	60.81

Unit: mm

C4201WRB-F-2xXP

4.20mm pitch 90° Dual Row Wafer With Foot

Reference Informations:

*Material:Pin:Brass

Pin Finish: See The ①

Insulator:Nylon 66,UL94V-0

*Mates with CJT C4201HFA-2xXP series Housing or C4201HV-2xXP series Header

*Color:Black

①

Ordering Information:

C4201WRB-F-2xXP - *** - ***
1 2 3

1.Part No.

2.Material:

(blank):Nylon 66,UL94V-0

GWT:Nylon 66,UL94V-0,GWT 750°C

3.Finish:

(blank):Tin over Nickel

G:Gold-flash

G15:15µm (0.38µm) MIN.Select Gold(Mating Area)

100µm (2.54µm) MIN.Select Tin

G30:30µm (0.76µm) MIN.Select Gold(Mating Area)

100µm (2.54µm) MIN.Select Tin

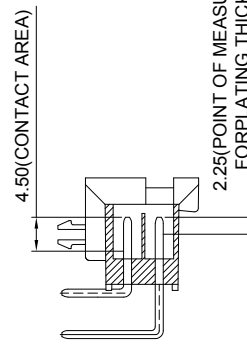
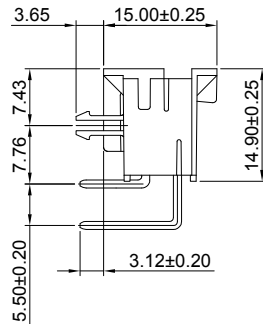
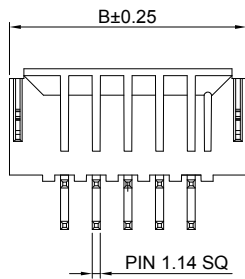
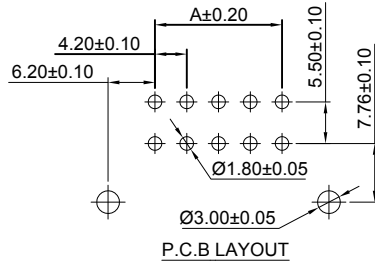
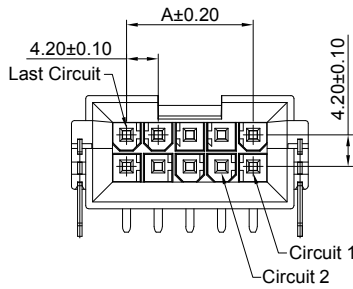
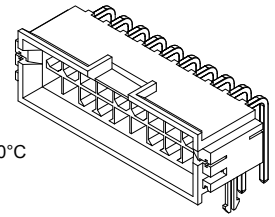

Ordering Information & Dimensions:

PART NO.	Dimensions	
	A	B
2x2P	4.20	18.81
2x3P	8.40	23.01
2x4P	12.60	27.21
2x5P	16.80	31.41
2x6P	21.00	35.61
2x7P	25.20	39.81
2x8P	29.40	44.01
2x9P	33.60	48.21
2x10P	37.80	52.41
2x11P	42.00	56.61
2x12P	46.20	60.81

Unit: mm

C4201WVC-2xXP

4.20mm pitch 180° Dual Row Wafer

Reference Informations:

*Material:Pin:Brass/Tin over Nickel

Insulator:Nylon 66,UL94V-2 or UL94V-0

*Mates with CJT C4201HFA-2xXP series Housing or C4201HV-2xXP series Header

*Color:Natural

Ordering Information:

C4201WVC-2xXP - *** - ***
1 2 3

1.Part No.

2.Material:

(blank):Nylon 66,UL94V-2/Natural

V0:Nylon 66,UL94V-0/White

GWT:Nylon 66,UL94V-0,GWT 750°C

3.Finish:

(blank):Tin over Nickel

G:Gold-flash

G15:15µm (0.38µm) MIN.Select Gold(Mating Area)

100µm (2.54µm) MIN.Select Tin

G30:30µm (0.76µm) MIN.Select Gold(Mating Area)

100µm (2.54µm) MIN.Select Tin

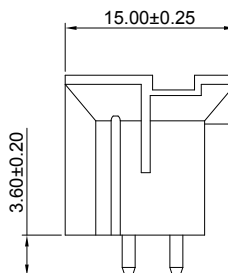
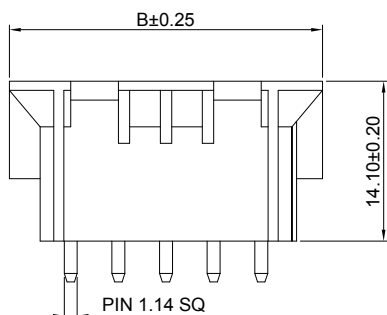
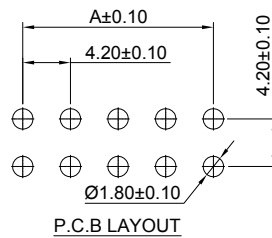
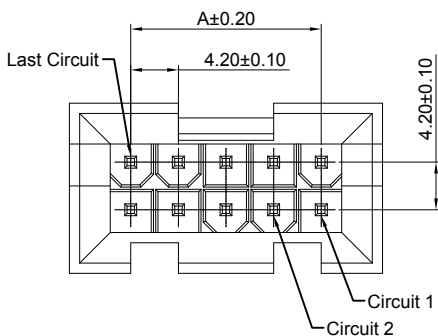

Ordering Information & Dimensions:

PART NO.	Dimensions	
	A	B
2x1P	----	10.80
2x2P	4.20	15.00
2x3P	8.40	19.20
2x4P	12.60	23.40
2x5P	16.80	27.60
2x6P	21.00	31.80
2x7P	25.20	36.00
2x8P	29.40	40.20
2x9P	33.60	44.40
2x10P	37.80	48.60
2x11P	42.00	52.80
2x12P	46.20	57.00
2x18P	71.40	82.20

Unit: mm

C4201WV-S-2xXP

4.20mm pitch 180° Dual Row Wafer - SMT TYPE - Without Drain Holes

Reference Informations:

- *Material:Pin:Brass/Tin over Nickel
Insulator:Nylon 6T,UL94V-0
- *Mates with CJT C4201HF,HFC-2xXP series Housing
- *Color:Natural

Ordering Information:

C4201WV-S-2xXP - *** - ***
1 2 3

- 1.Part No.
- 2.Material:
(blank):Nylon 6T,UL94V-0/Natural
LCP:LCP,UL94V-0/White
GWT:Nylon 6T,UL94V-0,GWT 750°C
- 3.Pin Material and Finish:
(blank):Brass/Tin over Nickel
G:Brass/Gold-flash
G15:Brass/15µm (0.38µm) MIN.Select Gold(Mating Area)
100µm (2.54µm) MIN.Select Tin
G30:Brass/30µm (0.76µm) MIN.Select Gold(Mating Area)
100µm (2.54µm) MIN.Select Tin
TCA:Copper Alloy/Tin over Nickel
GCA:Copper Alloy/Gold-flash
GCA-G15:Copper Alloy/15µm (0.38µm) MIN.Select Gold(Mating Area)
100µm (2.54µm) MIN.Select Tin
GCA-G30:Copper Alloy/30µm (0.76µm) MIN.Select Gold(Mating Area)
100µm (2.54µm) MIN.Select Tin

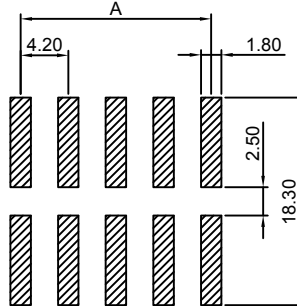
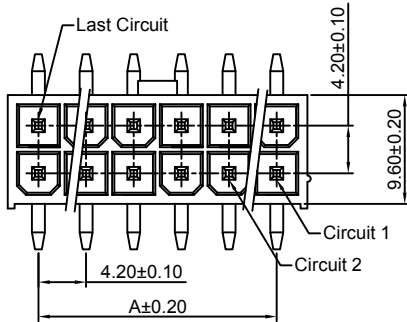

P.C.B LAYOUT

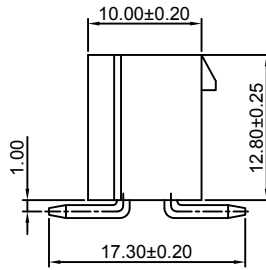
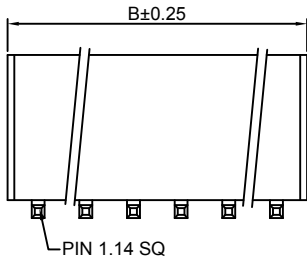

Ordering Information & Dimensions:

PART NO.	Dimensions	
	A	B
2x1P	----	5.60
2x2P	4.20	9.80
2x3P	8.40	14.00
2x4P	12.60	18.20
2x5P	16.80	22.40
2x6P	21.00	26.60
2x7P	25.20	30.80
2x8P	29.40	35.00
2x9P	33.60	39.20
2x10P	37.80	43.40
2x11P	42.00	47.60
2x12P	46.20	51.80

Unit: mm

C4201WVF-2xXP

4.20mm pitch 180° Dual Row Wafer

Reference Informations:

- *Material:Pin:Brass/Tin over Nickel
Insulator:Nylon 9T,UL94V-0
- *Color:Black

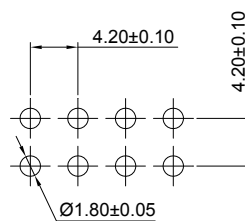
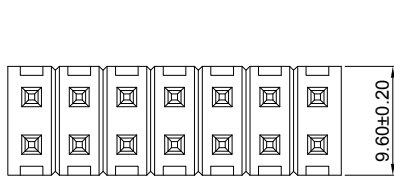

P.C.B LAYOUT

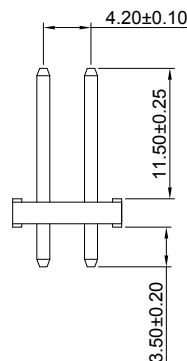
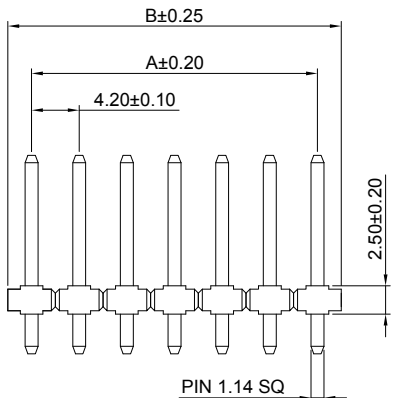

PART NO.	Dimensions	
	A	B
2x1P	----	4.20
2x2P	4.20	8.40
2x3P	8.40	12.60
2x4P	12.60	16.80
2x5P	16.80	21.00
2x6P	21.00	25.20
2x7P	25.20	29.40
2x8P	29.40	33.60
2x9P	33.60	37.80
2x10P	37.80	42.00
2x11P	42.00	46.20
2x12P	46.20	50.40

Unit: mm

C4201FS-T

4.19mm pitch Crimp Terminal

Reference Informations:

*Used in CJT C4201HFS,HFSB-XP,C4201HFS,HFSB-2xXP series Housing

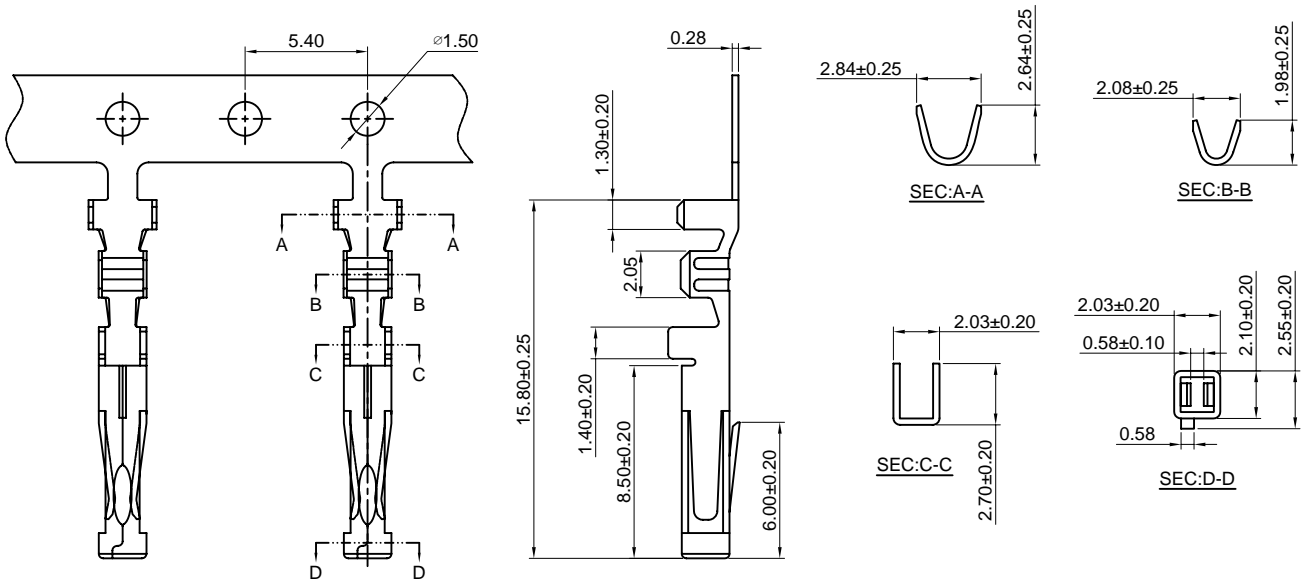

Ordering information & Specifications:

Unit:mm

Part NO.	Wire Range	Insulation O.D.	Material	Finish	Qty/reel
C4201FS-TP	AWG#20-#24	1.75mm(max)	Phosphor Bronze	Tin over Nickel	10,000 PCS
C4201FS-GP	AWG#20-#24	1.75mm(max)	Phosphor Bronze	Gold over Nickel	10,000 PCS

Optional Gold plating available but MOQ requested

C4201FS-T-H

4.19mm pitch Crimp Terminal

Reference Informations:

*Used in CJT C4201HFS,HFSB-XP,C4201HFS,HFSB-2xXP series Housing

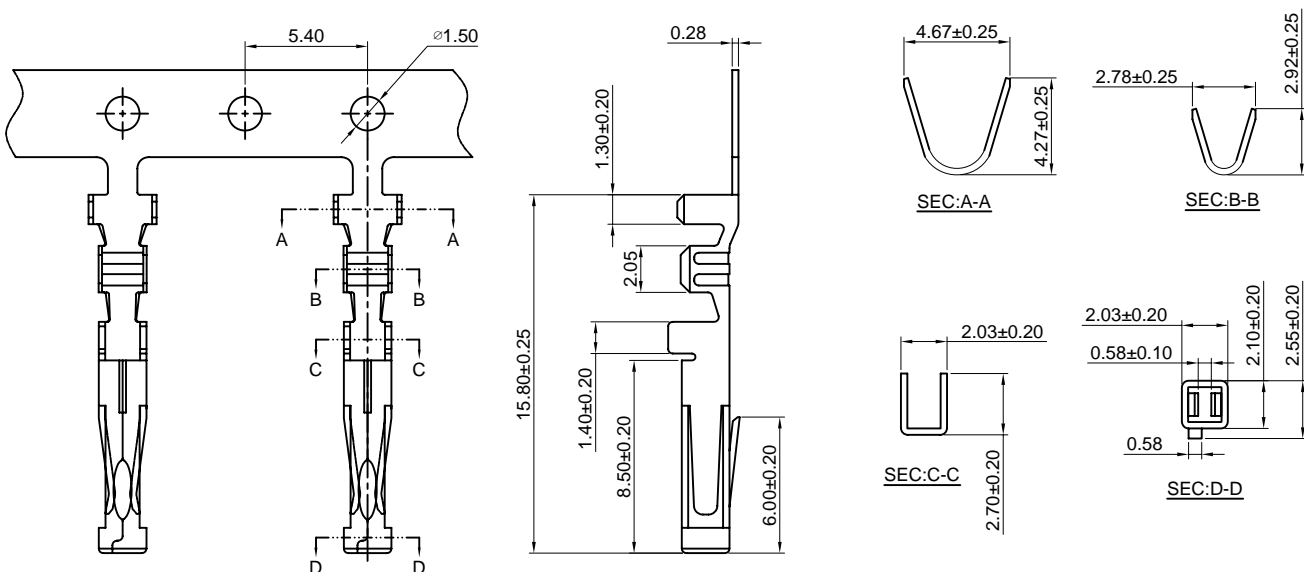

Ordering information & Specifications:

Unit:mm

Part NO.	Wire Range	Insulation O.D.	Material	Finish	Qty/reel
C4201FS-TP-H	AWG#16-#20	3.12mm(max)	Phosphor Bronze	Tin over Nickel	10,000 PCS
C4201FS-GP-H	AWG#16-#20	3.12mm(max)	Phosphor Bronze	Gold over Nickel	10,000 PCS

Optional Gold plating available but MOQ requested

C4201FS-T-L

4.19mm pitch Crimp Terminal

Reference Informations:

*Used in CJT C4201HFS,HFSB-XP,C4201HFS,HFSB-2xXP series Housing

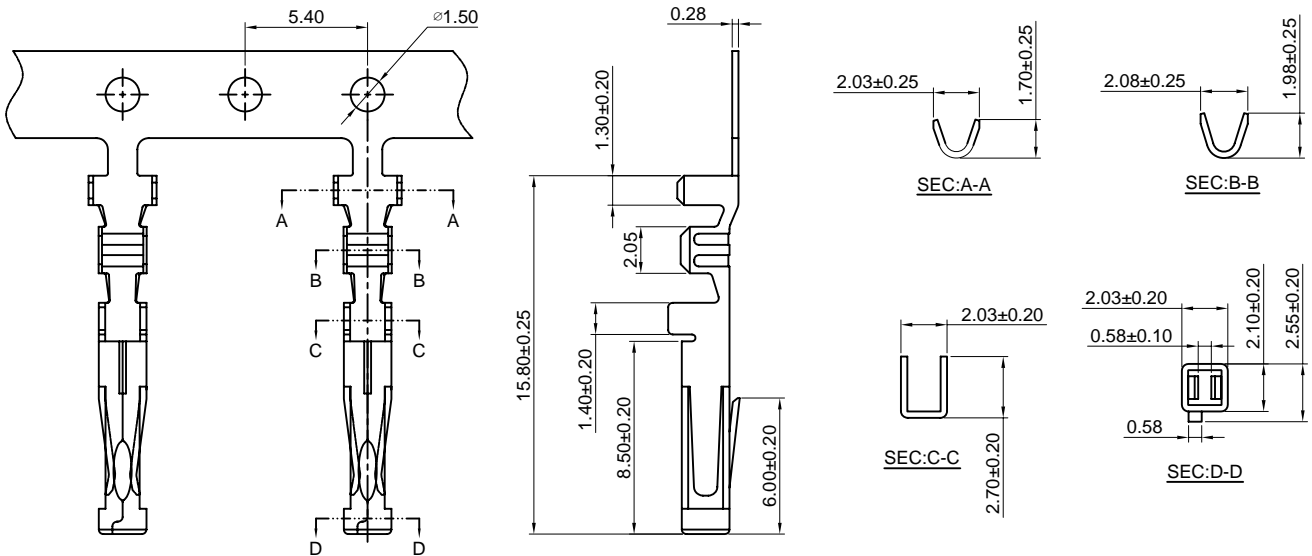

Ordering information & Specifications:

Unit:mm

Part NO	Wire Range	Insulation O.D.	Material	Finish	Qty/reel
C4201FS-TP-L	AWG#24-#26	1.50mm(max)	Phosphor Bronze	Tin over Nickel	10,000 PCS
C4201FS-GP-L	AWG#24-#26	1.50mm(max)	Phosphor Bronze	Gold over Nickel	10,000 PCS

Optional Gold plating available but MOQ requested

C4201HFS-XP

4.19mm Pitch Single Row Housing

Reference Informations:

- *Material:Nylon 66,UL94V-0
- *Suitable CJT C4201FS-T(-H/L) series Terminal
- *Mates with CJT C4201WVS,WRS-XP, C4201WVS-S-XP series Wafer
- *Color:Natural

Ordering Information:

C4201HFS-XP - ***
1 2

- 1.Part No.
- 2.Material:
(blank):Nylon 66,UL94V-0
GWT:Nylon 66,UL94V-0,GWT 750°C

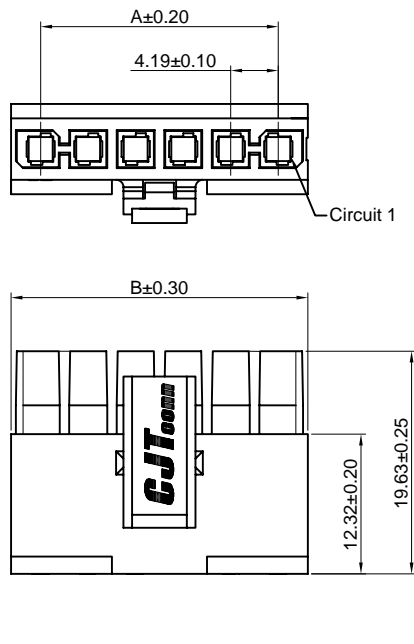

Ordering Information & Dimensions:

PART NO.	Dimensions	
	A	B
2P	4.19	9.40
3P	8.38	13.59
4P	12.57	17.78
5P	16.76	21.97
6P	20.95	26.16
7P	25.14	30.35
8P	29.33	34.54
9P	33.52	38.73
10P	37.71	42.92
11P	41.90	47.11
12P	46.09	51.30
13P	50.28	55.49
14P	54.47	59.68
15P	58.66	63.87

Unit: mm

C4201HFSB-XP

4.19mm Pitch Single Row Housing

Reference Informations:

- *Material:Nylon 66,UL94V-0
- *Suitable CJT C4201FS-T(-H/-L) series Terminal
- *Mates with CJT C4201WVSB,WRSB-XP, C4201WVSB-S-XP series Wafer
- *Color:Natural

Ordering Information:

- C4201HFSB-XP - ***
 $\frac{1}{2}$
- 1.Part No.
 - 2.Material:
 (blank):Nylon 66,UL94V-0
 GWT:Nylon 66,UL94V-0,GWT 750°C

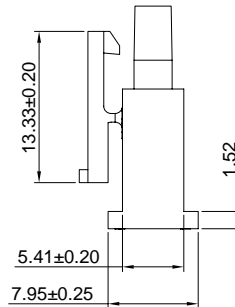
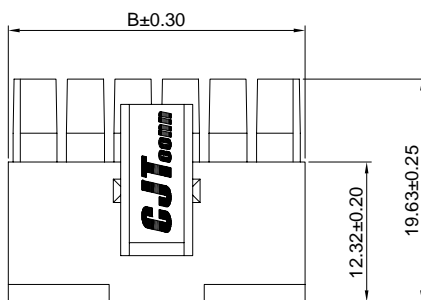
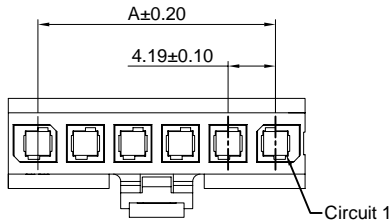

Ordering Information & Dimensions:

PART NO.	Dimensions	
	A	B
2P	4.19	9.40
3P	8.38	13.59
4P	12.57	17.78
5P	16.76	21.97
6P	20.95	26.16
7P	25.14	30.35
8P	29.33	34.54
9P	33.52	38.73
10P	37.71	42.92
11P	41.90	47.11
12P	46.09	51.30
13P	50.28	55.49
14P	54.47	59.68
15P	58.66	63.87

Unit: mm

C4201HFS-2xXP

4.19mm Pitch Dual Row Housing

Reference Informations:

- *Material:Nylon 66,UL94V-0
- *Suitable CJT C4201FS-T(-H/-L) series Terminal
- *Mates with CJT C4201WVS,WRS-2xXP, C4201WVS-S-2xXP series Wafer
- *Color:Natural

Ordering Information:

- C4201HFS-2xXP - ***
 $\frac{1}{2}$
- 1.Part No.
 - 2.Material:
 (blank):Nylon 66,UL94V-0
 GWT:Nylon 66,UL94V-0,GWT 750°C

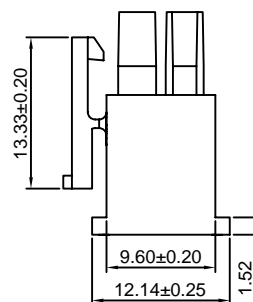
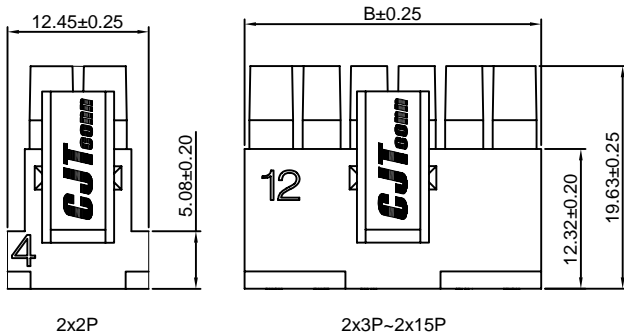
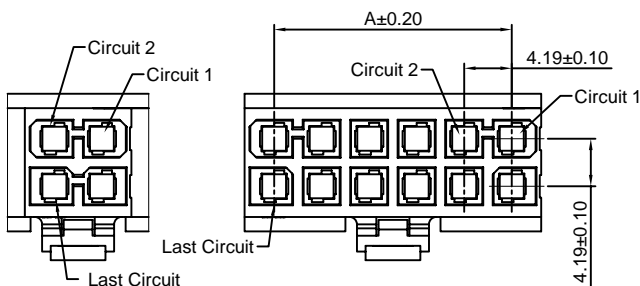

Ordering Information & Dimensions:

PART NO.	Dimensions	
	A	B
2x2P	4.19	12.45
2x3P	8.38	13.59
2x4P	12.57	17.78
2x5P	16.76	21.97
2x6P	20.95	26.16
2x7P	25.14	30.35
2x8P	29.33	34.54
2x9P	33.52	38.73
2x10P	37.71	42.92
2x11P	41.90	47.11
2x12P	46.09	51.30
2x13P	50.28	55.49
2x14P	54.47	59.68
2x15P	58.66	63.87

Unit: mm

C4201HFSB-2xXP

4.19mm Pitch Dual Row Housing

Reference Informations:

- *Material:Nylon 66,UL94V-0
- *Suitable CJT C4201FS-T(-H/-L) series Terminal
- *Mates with CJT C4201WVSB,WRSB-2xXP, C4201WVSB-S-2xXP series Wafer
- *Color:Natural

Ordering Information:

C4201HFSB-2xXP - ***
1 2

- 1.Part No.
- 2.Material:
(blank):Nylon 66,UL94V-0
GWT:Nylon 66,UL94V-0,GWT 750°C

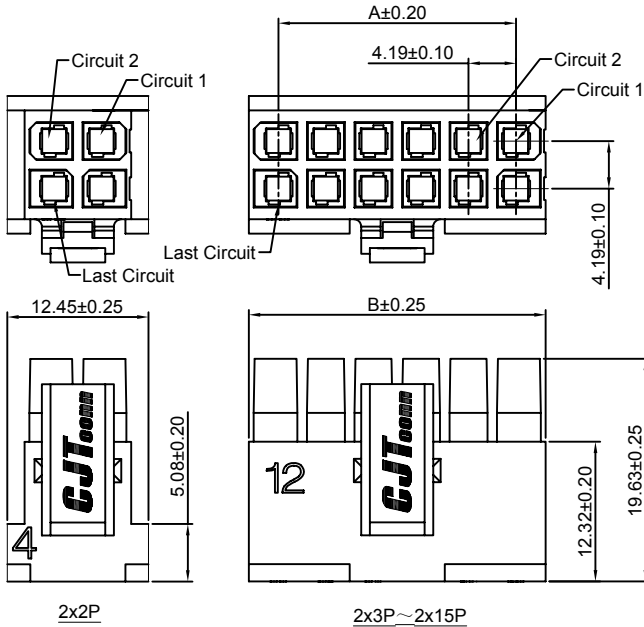

Ordering Information & Dimensions:

PART NO.	Dimensions	
	A	B
2x2P	4.19	12.45
2x3P	8.38	13.59
2x4P	12.57	17.78
2x5P	16.76	21.97
2x6P	20.95	26.16
2x7P	25.14	30.35
2x8P	29.33	34.54
2x9P	33.52	38.73
2x10P	37.71	42.92
2x11P	41.90	47.11
2x12P	46.09	51.30
2x13P	50.28	55.49
2x14P	54.47	59.68
2x15P	58.66	63.87

Unit: mm

C4201WVS-XP

4.19mm pitch 180° Single Row Wafer

Reference Informations:

- *Material:Pin:Brass/Tin over Nickel
Insulator:LCP,UL94V-0
- *Mates with CJT C4201HFS-XP series Housing
- *Color:Black

Ordering Information:

C4201WVS-XP - *** - ***
1 2 3

- 1.Part No.
- 2.Material:
(blank):LCP,UL94V-0
GWT:LCP,UL94V-0,GWT 750°C
- 3.Finish:
(blank):Tin over Nickel
G:Gold-flash
G15:15µin (0.38µm) MIN.Select Gold(Mating Area)
100µin (2.54µm) MIN.Select Tin
G30:30µin (0.76µm) MIN.Select Gold(Mating Area)
100µin (2.54µm) MIN.Select Tin

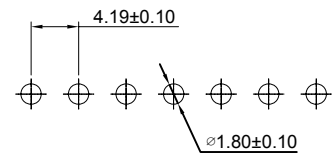

P.C.B LAYOUT

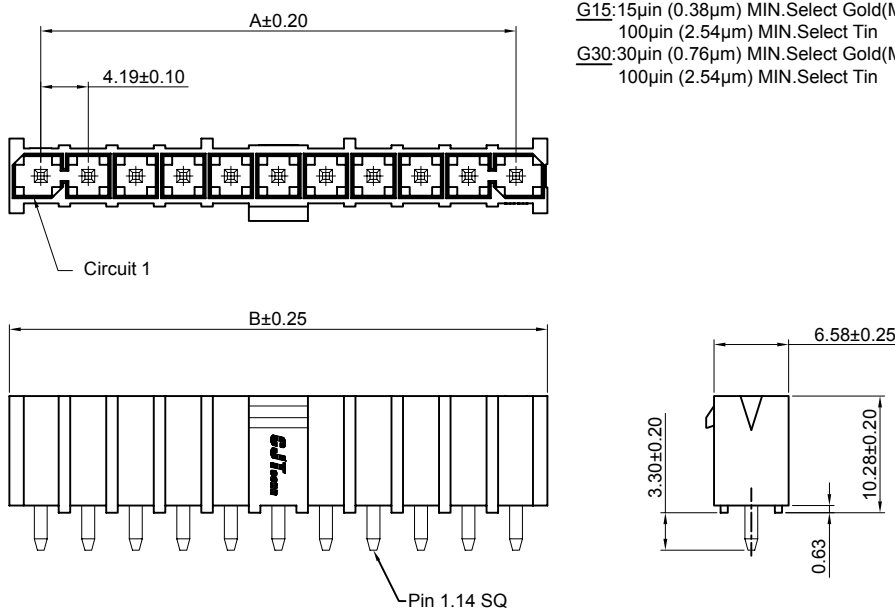

Ordering Information & Dimensions:

PART NO.	Dimensions	
	A	B
2P	4.19	9.40
3P	8.38	13.59
4P	12.57	17.78
5P	16.76	21.97
6P	20.95	26.16
7P	25.14	30.35
8P	29.33	34.54
9P	33.52	38.73
10P	37.71	42.92
11P	41.90	47.11
12P	46.09	51.30
13P	50.28	55.49
14P	54.47	59.68
15P	58.66	63.87

Unit: mm

C4201WVSB-XP

4.19mm pitch 180° Single Row Wafer

Reference Informations:

*Material:Pin:Brass/Tin over Nickel
Insulator:LCP,UL94V-0

*Mates with CJT C4201HFSB-XP series Housing

*Color:Black

Ordering Information:
C4201WVSB-XP - *** - ***
1 2 3

1.Part No.

2.Material:

(blank):LCP,UL94V-0

GWT:LCP,UL94V-0,GWT 750°C

3.Finish:

(blank):Tin over Nickel

G:Gold-flash

G15:15µin (0.38µm) MIN.Select Gold(Mating Area)

100µin (2.54µm) MIN.Select Tin

G30:30µin (0.76µm) MIN.Select Gold(Mating Area)

100µin (2.54µm) MIN.Select Tin

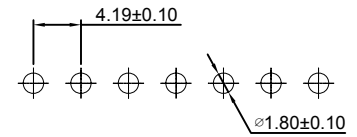

P.C.B LAYOUT

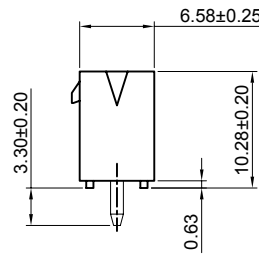
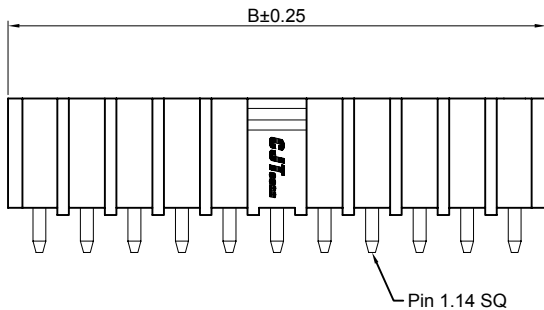
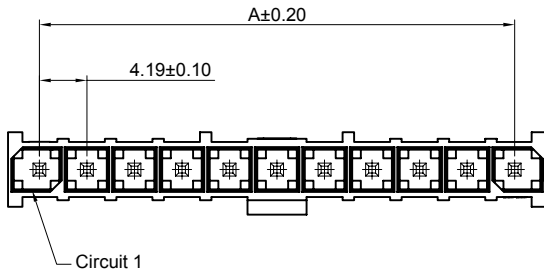

Ordering Information & Dimensions:

PART NO.	Dimensions	
	A	B
2P	4.19	9.40
3P	8.38	13.59
4P	12.57	17.78
5P	16.76	21.97
6P	20.95	26.16
7P	25.14	30.35
8P	29.33	34.54
9P	33.52	38.73
10P	37.71	42.92
11P	41.90	47.11
12P	46.09	51.30
13P	50.28	55.49
14P	54.47	59.68
15P	58.66	63.87

Unit: mm

C4201WVS-S-XP

4.19mm Pitch 180° Single Row Wafer - SMT TYPE

Reference Informations:

*Material:Pin:Brass/Tin over Nickel
Insulator:LCP,UL94V-0

*Mates with CJT C4201HFS-S-XP series Housing

*Color:Black

Ordering Information:
C4201WVS-S-XP - *** - ***
1 2 3

1.Part No.

2.Material:

(blank):LCP,UL94V-0

GWT:LCP,UL94V-0,GWT 750°C

3.Finish:

(blank):Tin over Nickel

G:Gold-flash

G15:15µin (0.38µm) MIN.Select Gold(Mating Area)

100µin (2.54µm) MIN.Select Tin

G30:30µin (0.76µm) MIN.Select Gold(Mating Area)

100µin (2.54µm) MIN.Select Tin

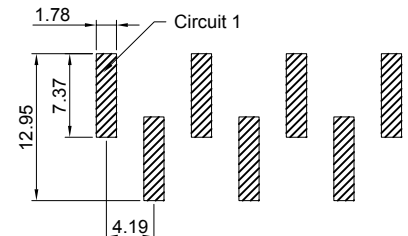

P.C.B LAYOUT

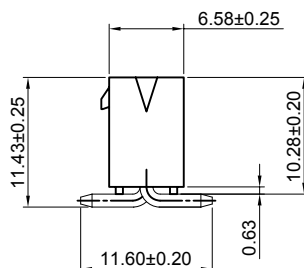
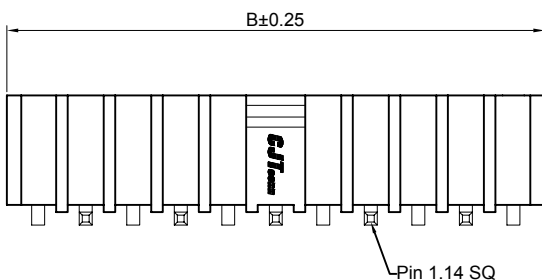
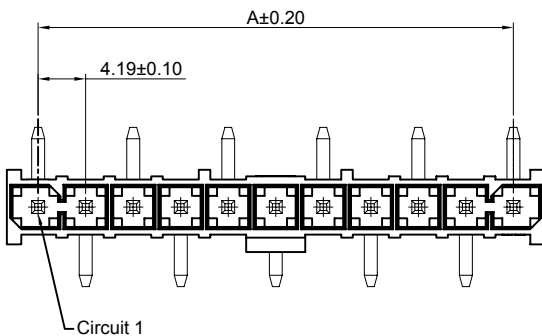

Ordering Information & Dimensions:

PART NO.	Dimensions	
	A	B
2P	4.19	9.40
3P	8.38	13.59
4P	12.57	17.78
5P	16.76	21.97
6P	20.95	26.16
7P	25.14	30.35
8P	29.33	34.54
9P	33.52	38.73
10P	37.71	42.92
11P	41.90	47.11
12P	46.09	51.30
13P	50.28	55.49
14P	54.47	59.68
15P	58.66	63.87

Unit: mm

C4201WVSB-S-XP

4.19mm Pitch 180° Single Row Wafer - SMT TYPE

Reference Informations:

- *Material:Pin:Brass/Tin over Nickel
Insulator:LCP,UL94V-0
- *Mates with CJT C4201HFSB-XP series Housing
- *Color:Black

Ordering Information:

C4201WVSB-S-XP - ^{***}/₁ - ^{***}/₂ - ^{***}/₃

- 1.Part No.
- 2.Material:
(blank):LCP,UL94V-0
GWT:LCP,UL94V-0,GWT 750°C
- 3.Finish:
(blank):Tin over Nickel
G:Gold-flash
G15:15µin (0.38µm) MIN.Select Gold(Mating Area)
100µin (2.54µm) MIN.Select Tin
G30:30µin (0.76µm) MIN.Select Gold(Mating Area)
100µin (2.54µm) MIN.Select Tin

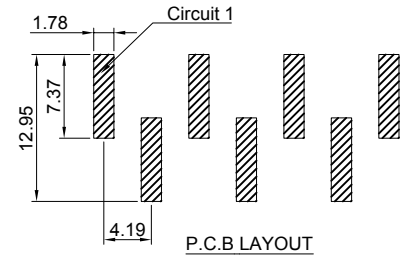

P.C.B LAYOUT

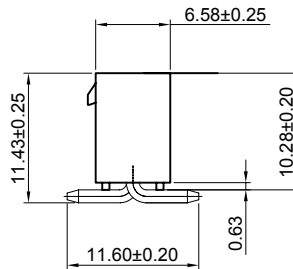
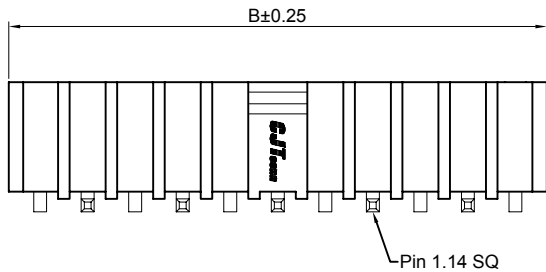
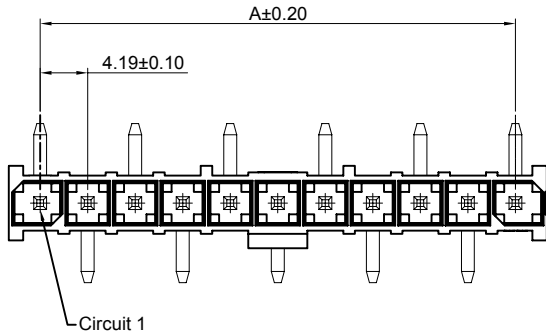

Ordering Information & Dimensions:

PART NO.	Dimensions	
	A	B
2P	4.19	9.40
3P	8.38	13.59
4P	12.57	17.78
5P	16.76	21.97
6P	20.95	26.16
7P	25.14	30.35
8P	29.33	34.54
9P	33.52	38.73
10P	37.71	42.92
11P	41.90	47.11
12P	46.09	51.30
13P	50.28	55.49
14P	54.47	59.68
15P	58.66	63.87

Unit: mm

C4201WRS-XP

4.19mm pitch 90° Single Row Wafer

Reference Informations:

- *Material:Pin:Brass/Tin over Nickel
Insulator:LCP,UL94V-0
- *Mates with CJT C4201HFS-XP series Housing
- *Color:Black

Ordering Information:

C4201WRS-XP - ^{***}/₁ - ^{***}/₂ - ^{***}/₃

- 1.Part No.
- 2.Material:
(blank):LCP,UL94V-0
GWT:LCP,UL94V-0,GWT 750°C
- 3.Finish:
(blank):Tin over Nickel
G:Gold-flash
G15:15µin (0.38µm) MIN.Select Gold(Mating Area)
100µin (2.54µm) MIN.Select Tin
G30:30µin (0.76µm) MIN.Select Gold(Mating Area)
100µin (2.54µm) MIN.Select Tin

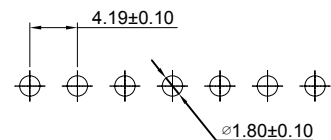

P.C.B LAYOUT

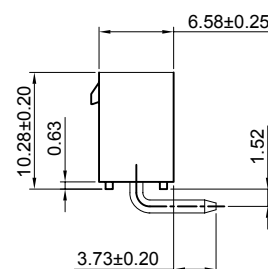
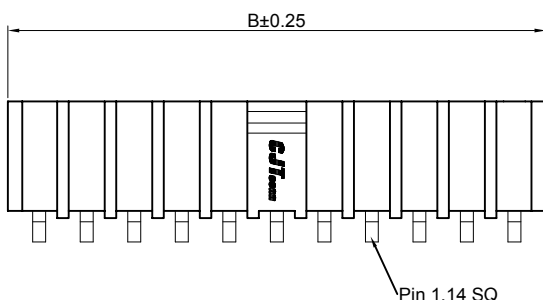
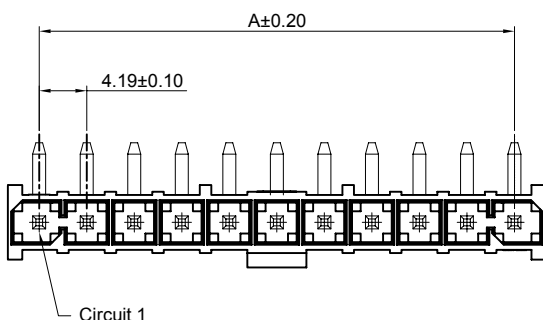

Ordering Information & Dimensions:

PART NO.	Dimensions	
	A	B
2P	4.19	9.40
3P	8.38	13.59
4P	12.57	17.78
5P	16.76	21.97
6P	20.95	26.16
7P	25.14	30.35
8P	29.33	34.54
9P	33.52	38.73
10P	37.71	42.92
11P	41.90	47.11
12P	46.09	51.30
13P	50.28	55.49
14P	54.47	59.68
15P	58.66	63.87

Unit: mm

C4201WRSB-XP

4.19mm Pitch 90° Single Row Wafer

Reference Informations:

- *Material: Pin: Brass/Tin over Nickel
Insulator: LCP, UL94V-0
- *Mates with CJT C4201HFSB-XP series Housing
- *Color: Black

Ordering Information:

C4201WRSB-XP - *** - ***
1 2 3

- Part No.
- Material:
(blank): LCP, UL94V-0
GWT: LCP, UL94V-0, GWT 750°C
- Finish:
(blank): Tin over Nickel
G: Gold-flash
G15: 15µm (0.38µm) MIN. Select Gold (Mating Area)
100µm (2.54µm) MIN. Select Tin
G30: 30µm (0.76µm) MIN. Select Gold (Mating Area)
100µm (2.54µm) MIN. Select Tin

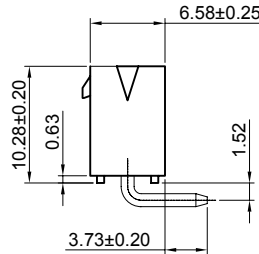
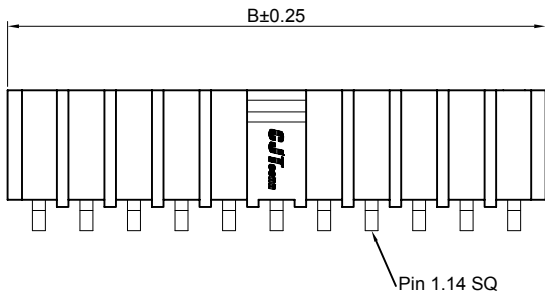
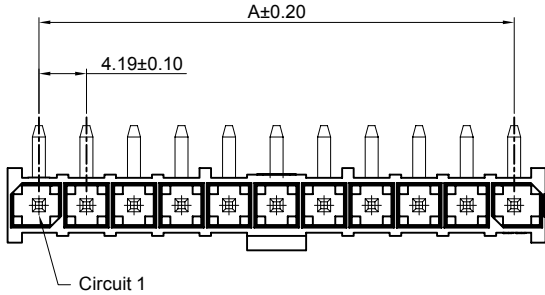
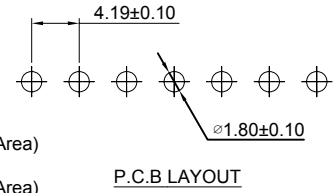

Ordering Information & Dimensions:

PART NO.	Dimensions	
	A	B
2P	4.19	9.40
3P	8.38	13.59
4P	12.57	17.78
5P	16.76	21.97
6P	20.95	26.16
7P	25.14	30.35
8P	29.33	34.54
9P	33.52	38.73
10P	37.71	42.92
11P	41.90	47.11
12P	46.09	51.30
13P	50.28	55.49
14P	54.47	59.68
15P	58.66	63.87

Unit: mm

C4201WVS-2xXP

4.19mm pitch 180° Dual Row Wafer

Reference Informations:

- *Material: Pin: Brass/Tin over Nickel
Insulator: LCP, UL94V-0
- *Mates with CJT C4201HFS-2xXP series Housing
- *Color: Black

Ordering Information:

C4201WVS-2xXP - *** - ***
1 2 3

- Part No.
- Material:
(blank): LCP, UL94V-0
GWT: LCP, UL94V-0, GWT 750°C
- Finish:
(blank): Tin over Nickel
G: Gold-flash
G15: 15µm (0.38µm) MIN. Select Gold (Mating Area)
100µm (2.54µm) MIN. Select Tin
G30: 30µm (0.76µm) MIN. Select Gold (Mating Area)
100µm (2.54µm) MIN. Select Tin

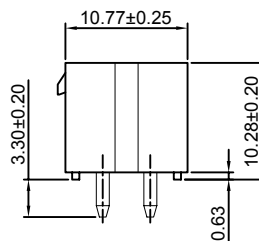
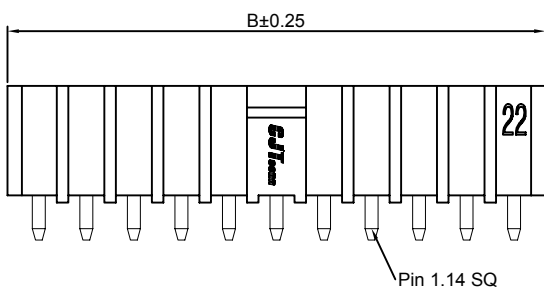
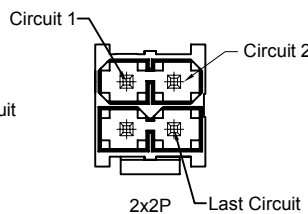
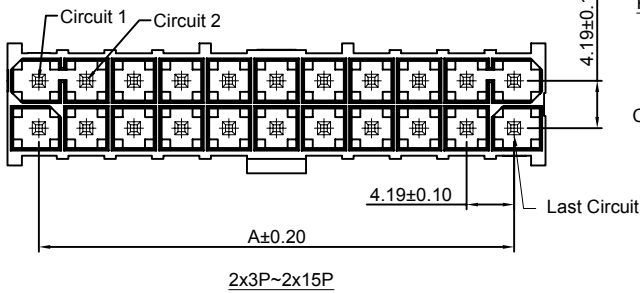
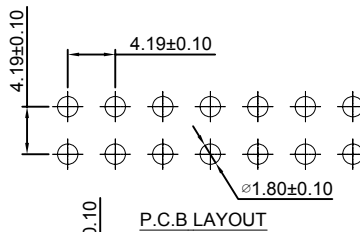

Ordering Information & Dimensions:

PART NO.	Dimensions	
	A	B
2x2P	4.19	9.40
2x3P	8.38	13.59
2x4P	12.57	17.78
2x5P	16.76	21.97
2x6P	20.95	26.16
2x7P	25.14	30.35
2x8P	29.33	34.54
2x9P	33.52	38.73
2x10P	37.71	42.92
2x11P	41.90	47.11
2x12P	46.09	51.30
2x13P	50.28	55.49
2x14P	54.47	59.68
2x15P	58.66	63.87

Unit: mm

C4201WVSB-2xXP

4.19mm pitch 180° Dual Row Wafer

Reference Informations:

- *Material: Pin: Brass/Tin over Nickel
Insulator: LCP, UL94V-0
- *Mates with CJT C4201HFSB-2xXP series Housing
- *Color: Black

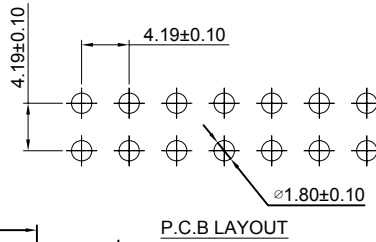

Ordering Information:

C4201WVSB-2xXP - *** - ***
1 2 3

- Part No.
- Material:
(blank): LCP, UL94V-0
GWT: LCP, UL94V-0, GWT 750°C
- Finish:
(blank): Tin over Nickel
G: Gold-flash
G15: 15µm (0.38µm) MIN. Select Gold (Mating Area)
100µm (2.54µm) MIN. Select Tin
G30: 30µm (0.76µm) MIN. Select Gold (Mating Area)
100µm (2.54µm) MIN. Select Tin

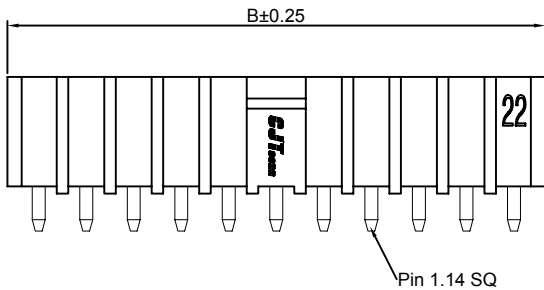
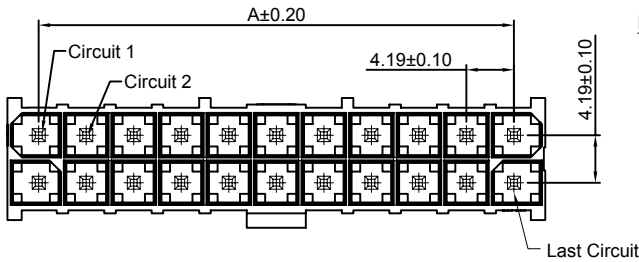

Ordering Information & Dimensions:

PART NO.	Dimensions	
	A	B
2x2P	4.19	9.40
2x3P	8.38	13.59
2x4P	12.57	17.78
2x5P	16.76	21.97
2x6P	20.95	26.16
2x7P	25.14	30.35
2x8P	29.33	34.54
2x9P	33.52	38.73
2x10P	37.71	42.92
2x11P	41.90	47.11
2x12P	46.09	51.30
2x13P	50.28	55.49
2x14P	54.47	59.68
2x15P	58.66	63.87

Unit: mm

C4201WVS-S-2xXP

4.19mm Pitch 180° Dual Row Wafer - SMT TYPE

Reference Informations:

- *Material: Pin: Brass/Tin over Nickel
Insulator: LCP, UL94V-0
- *Mates with CJT C4201HFS-2xXP series Housing
- *Color: Black

Ordering Information:

C4201WVS-S-2xXP - *** - ***
1 2 3

- Part No.
- Material:
(blank): LCP, UL94V-0
GWT: LCP, UL94V-0, GWT 750°C
- Finish:
(blank): Tin over Nickel
G: Gold-flash
G15: 15µm (0.38µm) MIN. Select Gold (Mating Area)
100µm (2.54µm) MIN. Select Tin
G30: 30µm (0.76µm) MIN. Select Gold (Mating Area)
100µm (2.54µm) MIN. Select Tin

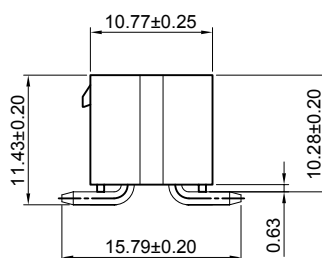
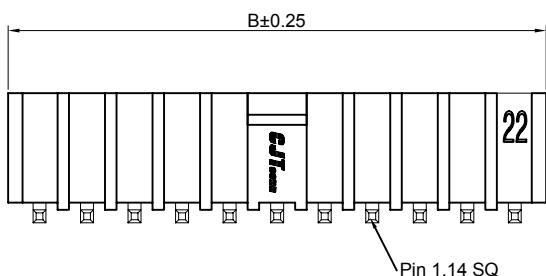
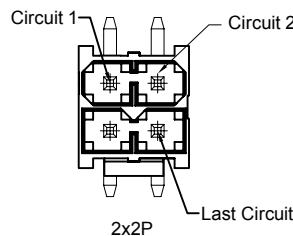
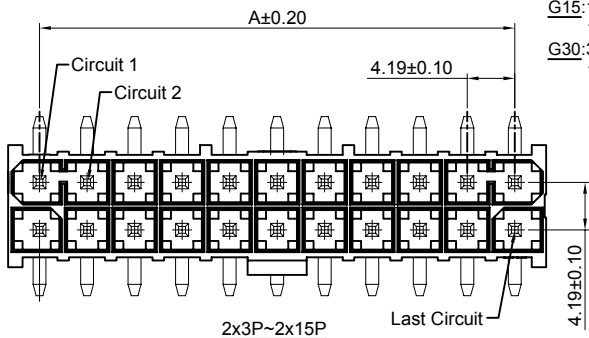
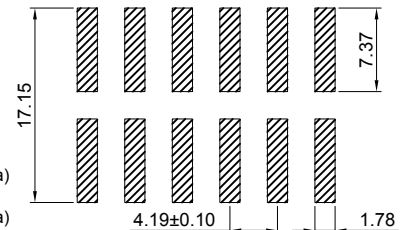

Ordering Information & Dimensions:

PART NO.	Dimensions	
	A	B
2x2P	4.19	9.40
2x3P	8.38	13.59
2x4P	12.57	17.78
2x5P	16.76	21.97
2x6P	20.95	26.16
2x7P	25.14	30.35
2x8P	29.33	34.54
2x9P	33.52	38.73
2x10P	37.71	42.92
2x11P	41.90	47.11
2x12P	46.09	51.30
2x13P	50.28	55.49
2x14P	54.47	59.68
2x15P	58.66	63.87

Unit: mm

C4201WVSB-S-2xXP

4.19mm Pitch 180° Dual Row Wafer - SMT TYPE

Reference Informations:

- *Material: Pin: Brass/Tin over Nickel
Insulator: LCP, UL94V-0
- *Mates with CJT C4201HFSB-2xXP series Housing
- *Color: Black

- Ordering Information:
C4201WVSB-S-2xXP - *** - ***
1 2 3
1. Part No.
 2. Material:
(blank): LCP, UL94V-0
GWT: LCP, UL94V-0, GWT 750°C
 3. Finish:
(blank): Tin over Nickel
G: Gold-flash
G15: 15µm (0.38µm) MIN. Select Gold (Mating Area)
100µm (2.54µm) MIN. Select Tin
G30: 30µm (0.76µm) MIN. Select Gold (Mating Area)
100µm (2.54µm) MIN. Select Tin

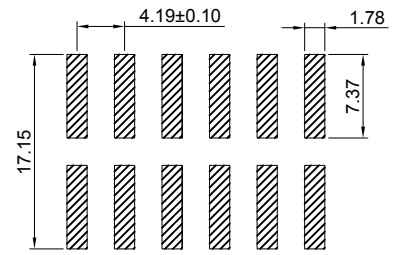

P.C.B LAYOUT

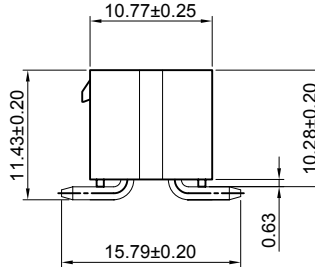
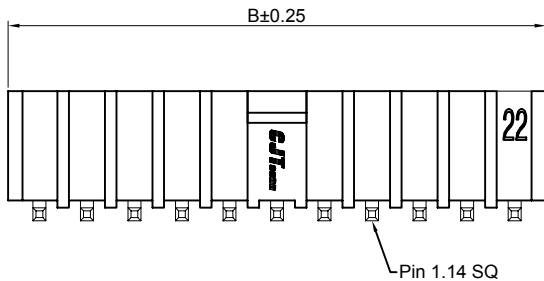
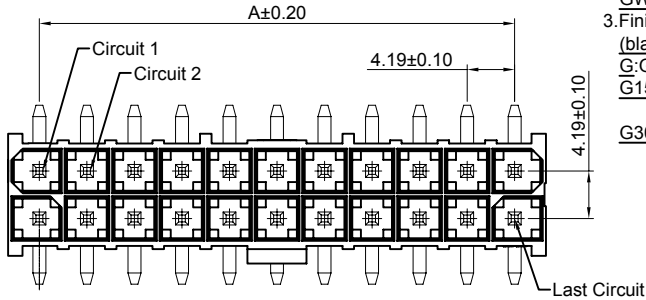

Ordering Information & Dimensions:

PART NO.	Dimensions	
	A	B
2x2P	4.19	9.40
2x3P	8.38	13.59
2x4P	12.57	17.78
2x5P	16.76	21.97
2x6P	20.95	26.16
2x7P	25.14	30.35
2x8P	29.33	34.54
2x9P	33.52	38.73
2x10P	37.71	42.92
2x11P	41.90	47.11
2x12P	46.09	51.30
2x13P	50.28	55.49
2x14P	54.47	59.68
2x15P	58.66	63.87

Unit: mm

C4201WRS-2xXP

4.19mm pitch 90° Dual Row Wafer

Reference Informations:

- *Material: Pin: Brass/Tin over Nickel
Insulator: LCP, UL94V-0
- *Mates with CJT C4201HFS-2xXP series Housing
- *Color: Black

- Ordering Information:
C4201WRS-2xXP - *** - ***
1 2 3
1. Part No.
 2. Material:
(blank): LCP, UL94V-0
GWT: LCP, UL94V-0, GWT 750°C
 3. Finish:
(blank): Tin over Nickel
G: Gold-flash
G15: 15µm (0.38µm) MIN. Select Gold (Mating Area)
100µm (2.54µm) MIN. Select Tin
G30: 30µm (0.76µm) MIN. Select Gold (Mating Area)
100µm (2.54µm) MIN. Select Tin

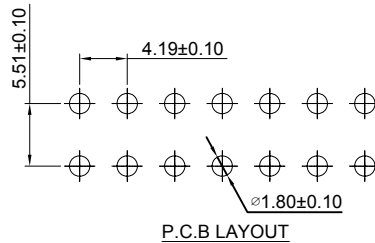

P.C.B LAYOUT

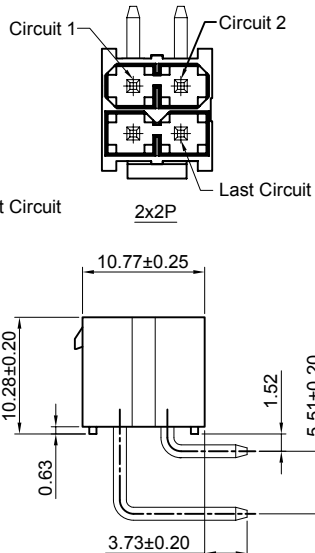
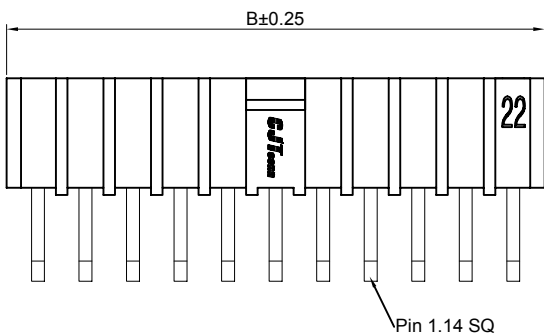
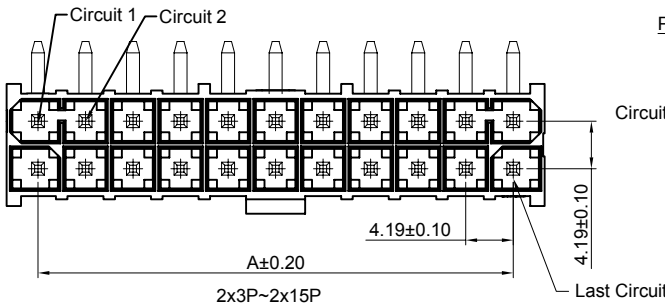

Ordering Information & Dimensions:

PART NO.	Dimensions	
	A	B
2x2P	4.19	9.40
2x3P	8.38	13.59
2x4P	12.57	17.78
2x5P	16.76	21.97
2x6P	20.95	26.16
2x7P	25.14	30.35
2x8P	29.33	34.54
2x9P	33.52	38.73
2x10P	37.71	42.92
2x11P	41.90	47.11
2x12P	46.09	51.30
2x13P	50.28	55.49
2x14P	54.47	59.68
2x15P	58.66	63.87

Unit: mm

C4201WRSB-2xXP

4.19mm Pitch 90° Dual Row Wafer

Reference Informations:

- *Material: Pin: Brass/Tin over Nickel
Insulator: LCP, UL94V-0
- *Mates with CJT C4201HFSB-2xXP series Housing
- *Color: Black

Ordering Information:

C4201WRSB-2xXP - ^{***}/₂ - ^{***}/₃

1. Part No.
2. Material:
(blank): LCP, UL94V-0
GWT: LCP, UL94V-0, GWT 750°C
3. Finish:
(blank): Tin over Nickel
G: Gold-flash
G15: 15µin (0.38µm) MIN. Select Gold (Mating Area)
100µin (2.54µm) MIN. Select Tin
G30: 30µin (0.76µm) MIN. Select Gold (Mating Area)
100µin (2.54µm) MIN. Select Tin

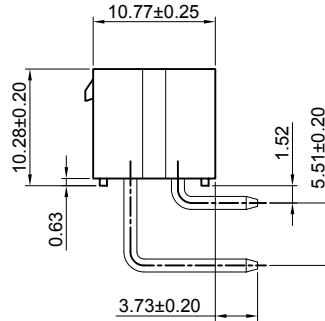
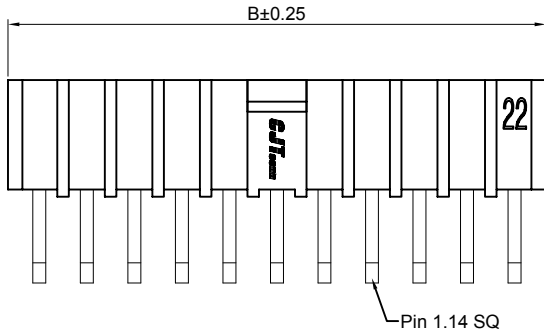
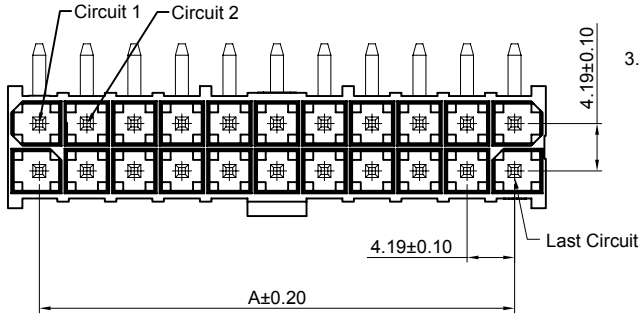
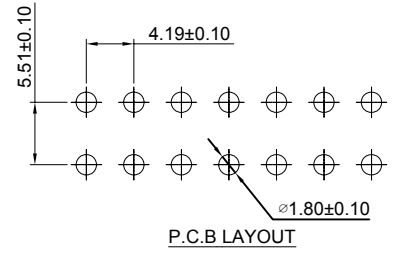

Ordering Information & Dimensions:

PART NO.	Dimensions	
	A	B
2x2P	4.19	9.40
2x3P	8.38	13.59
2x4P	12.57	17.78
2x5P	16.76	21.97
2x6P	20.95	26.16
2x7P	25.14	30.35
2x8P	29.33	34.54
2x9P	33.52	38.73
2x10P	37.71	42.92
2x11P	41.90	47.11
2x12P	46.09	51.30
2x13P	50.28	55.49
2x14P	54.47	59.68
2x15P	58.66	63.87

Unit: mm