

High Side Power Switches

Features

- 1.7V to 5.5V Input Voltage Range
- 2A Continuous Operating Current
- 77 mΩ (typ.) $R_{DS(ON)}$
- Built-In Level Shift for Control Logic; Can be Operated by 1.5V Logic
- Low 2 μA Quiescent Current
- Soft-Start: MIC94062, MIC94063
- Micropower Shutdown <1 μA
- Load Discharge Circuit: MIC94061, MIC94063
- Space Saving 1.2 mm x 1.6 mm UDFN Package

Applications

- Load Switch in Portable Applications
 - Cellular Phones
 - PDAs
 - MP3 Players
 - Digital Cameras
 - Portable Instrumentation
- Battery Switch-Over Circuits
- Level Translator

General Description

The MIC94060, MIC94061, MIC94062, and MIC94063 are high-side load switches designed for operation between 1.7V to 5.5V. The devices contain a low on-resistance P-channel MOSFET that supports over 2A of continuous current. The MIC94061 and MIC94063 feature an active load discharge circuit which ensures capacitive loads retain no charge when the main switch is in an OFF state.

MIC94060-61 feature rapid turn-on while MIC94062-63 provide a slew-rate controlled soft-start turn-on of 800 μs (typical) to prevent in-rush current from glitching supply rails.

An active pull-down on the enable input keeps MIC94060-63 in a default OFF state until the EN pin is pulled to a high level. Built-in level shift circuitry allows low voltage logic signals to switch higher supply voltages, or vice versa; high level logic signals can control low level voltages.

MIC94060-63's operating voltage range makes them suitable for 1-cell Lithium ion and 2- to 3-cell NiMH/NiCad/Alkaline powered systems, as well as all 5V applications. Their low operating current of 2 μA and low shutdown current of <1 μA maximize battery life.

Package Types

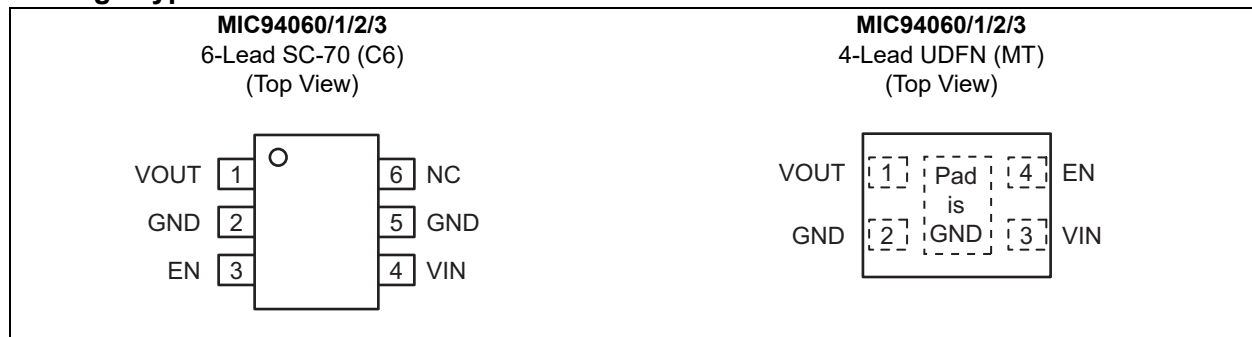

MIC94060/1/2/3

Typical Application Circuits

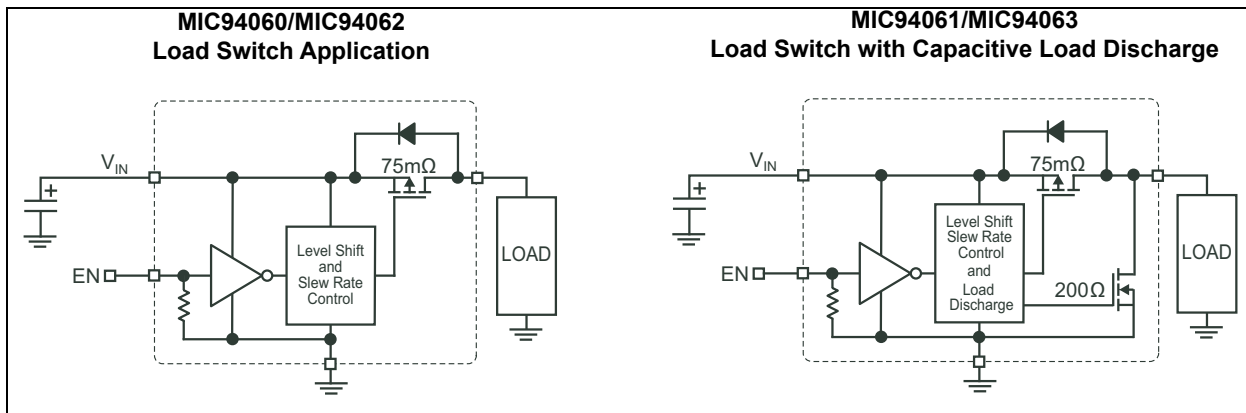

1.0 ELECTRICAL CHARACTERISTICS

Absolute Maximum Ratings †

Input Voltage (V_{IN})	+6V
Enable Voltage (V_{EN})	+6V
Continuous Drain Current (I_D) (Note 1)	
$T_A = 25^\circ\text{C}$	$\pm 2\text{A}$
$T_A = 85^\circ\text{C}$	$\pm 1.4\text{A}$
Pulsed Drain Current (I_{DP}) (Note 2)	$\pm 6\text{A}$
Continuous Diode Current (I_S) (Note 3)	-50 mA
ESD Rating, HBM (Note 4)	4 kV

Operating Ratings ††

Input Voltage (V_{IN})	+1.7V to +5.5V
----------------------------	----------------

† **Notice:** Stresses above those listed under “Absolute Maximum Ratings” may cause permanent damage to the device. This is a stress rating only and functional operation of the device at those or any other conditions above those indicated in the operational sections of this specification is not intended. Exposure to maximum rating conditions for extended periods may affect device reliability.

†† **Notice:** The device is not guaranteed to function outside its operating ratings.

Note 1: With backside thermal contact to PCB.

2: Pulse width <300 μs with <2% duty cycle.

3: Continuous body diode current conduction (reverse conduction, i.e. V_{OUT} to V_{IN}) is not recommended.

4: Devices are ESD sensitive. Handling precautions recommended. Human body model, 1.5 k Ω in series with 100 pF.

ELECTRICAL CHARACTERISTICS

Electrical Characteristics: $V_{IN} = 5\text{V}$; $T_A = +25^\circ\text{C}$, **bold** values valid for $-40^\circ\text{C} \leq T_A \leq +85^\circ\text{C}$, unless noted.

Parameter	Symbol	Min.	Typ.	Max.	Units	Conditions
Enable Threshold Voltage	V_{EN_TH}	0.5	—	1.2	V	$V_{IN} = 1.8\text{V to } 4.5\text{V}$, $I_D = -250 \mu\text{A}$
		0.4	—	1.2		$V_{IN} = 1.7\text{V to } 4.5\text{V}$, $I_D = -250 \mu\text{A}$
Enable Input Current	I_{EN}	—	2	4	μA	$V_{IN} = V_{EN} = 5.5\text{V}$
OFF State Leakage Current	I_{VIN}	—	—	1	μA	$V_{IN} = +5.5\text{V}$, $V_{EN} = 0\text{V}$
P-Channel Drain to Source ON Resistance, SC-70 Package	$R_{DS(ON)}$	—	77	110	m Ω	$V_{IN} = +4.5\text{V}$, $I_D = -100 \text{ mA}$, $V_{EN} = 1.5\text{V}$
		—	85	115		$V_{IN} = +3.6\text{V}$, $I_D = -100 \text{ mA}$, $V_{EN} = 1.5\text{V}$
		—	100	140		$V_{IN} = +2.5\text{V}$, $I_D = -100 \text{ mA}$, $V_{EN} = 1.5\text{V}$
		—	145	200		$V_{IN} = +1.8\text{V}$, $I_D = -100 \text{ mA}$, $V_{EN} = 1.5\text{V}$
		—	155	215		$V_{IN} = +1.7\text{V}$, $I_D = -100 \text{ mA}$, $V_{EN} = 1.5\text{V}$
P-Channel Drain to Source ON Resistance, UDFN Package	$R_{DS(ON)}$	—	85	115	m Ω	$V_{IN} = +4.5\text{V}$, $I_D = -100 \text{ mA}$, $V_{EN} = 1.5\text{V}$
		—	100	140		$V_{IN} = +3.6\text{V}$, $I_D = -100 \text{ mA}$, $V_{EN} = 1.5\text{V}$
		—	145	200		$V_{IN} = +2.5\text{V}$, $I_D = -100 \text{ mA}$, $V_{EN} = 1.5\text{V}$
		—	155	215		$V_{IN} = +1.8\text{V}$, $I_D = -100 \text{ mA}$, $V_{EN} = 1.5\text{V}$
		—	165	225		$V_{IN} = +1.7\text{V}$, $I_D = -100 \text{ mA}$, $V_{EN} = 1.5\text{V}$
Turn-Off Resistance	R_{SHDN}	—	200	300	Ω	$V_{IN} = +3.6\text{V}$, $I_{TEST} = 1 \text{ mA}$, $V_{EN} = 0\text{V}$, MIC94061, 63

MIC94060/1/2/3

ELECTRICAL CHARACTERISTICS (CONTINUED)

Electrical Characteristics: $V_{IN} = 5V$; $T_A = +25^\circ C$, **bold** values valid for $-40^\circ C \leq T_A \leq +85^\circ C$, unless noted.

Parameter	Symbol	Min.	Typ.	Max.	Units	Conditions
Dynamic						
Turn-On Delay Time	t_{ON_DLY}	—	0.85	1.5	μs	$V_{IN} = +3.6V$, $I_D = -100 mA$, $V_{EN} = 1.5V$, MIC94060, 61
		—	700	1200		$V_{IN} = +3.6V$, $I_D = -100 mA$, $V_{EN} = 1.5V$, MIC94062, 63
Turn-On Rise Time	t_{ON_RISE}	0.5	1	5	μs	$V_{IN} = +3.6V$, $I_D = -100 mA$, $V_{EN} = 1.5V$, MIC94060, 61
		500	800	1500		$V_{IN} = +3.6V$, $I_D = -100 mA$, $V_{EN} = 1.5V$, MIC94062, 63
Turn-Off Delay Time	t_{OFF_DLY}	—	100	200	ns	$V_{IN} = +3.6V$, $I_D = -100 mA$, $V_{EN} = 1.5V$, MIC94060, 61
		—	60	200		$V_{IN} = +3.6V$, $I_D = -100 mA$, $V_{EN} = 1.5V$, MIC94062, 63
Turn-Off Fall Time	t_{OFF_FALL}	—	60	100	ns	$V_{IN} = +3.6V$, $I_D = -100 mA$, $V_{EN} = 1.5V$, MIC94060, 61
		—	60	100		$V_{IN} = +3.6V$, $I_D = -100 mA$, $V_{EN} = 1.5V$, MIC94062, 63

TEMPERATURE SPECIFICATIONS

Parameters	Sym.	Min.	Typ.	Max.	Units	Conditions
Temperature Ranges						
Junction Temperature Range	T_J	-40	—	+125	$^\circ C$	—
Storage Temperature Range	T_S	-55	—	+150	$^\circ C$	—
Package Thermal Resistances						
Thermal Resistance, SC-70 6-Ld	θ_{JA}	—	240	—	$^\circ C/W$	—
Thermal Resistance, UDFN 4-Ld	θ_{JA}	—	172	—	$^\circ C/W$	—
Thermal Resistance, UDFN 4-Ld	θ_{JC}	—	134	—	$^\circ C/W$	—

Note 1: The maximum allowable power dissipation is a function of ambient temperature, the maximum allowable junction temperature and the thermal resistance from junction to air (i.e., T_A , T_J , θ_{JA}). Exceeding the maximum allowable power dissipation will cause the device operating junction temperature to exceed the maximum +125 $^\circ C$ rating. Sustained junction temperatures above +125 $^\circ C$ can impact the device reliability.

2.0 TYPICAL PERFORMANCE CURVES

Note: The graphs and tables provided following this note are a statistical summary based on a limited number of samples and are provided for informational purposes only. The performance characteristics listed herein are not tested or guaranteed. In some graphs or tables, the data presented may be outside the specified operating range (e.g., outside specified power supply range) and therefore outside the warranted range.

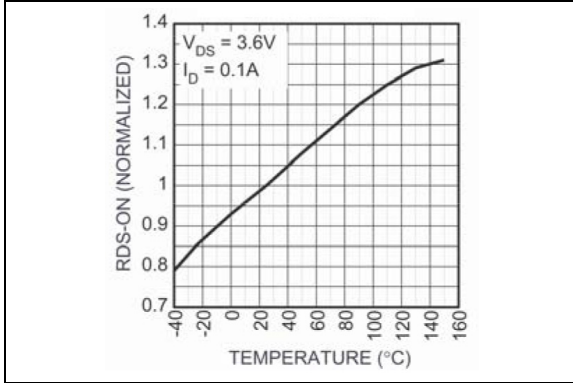

FIGURE 2-1: $R_{DS(ON)}$ Variance with Temperature.

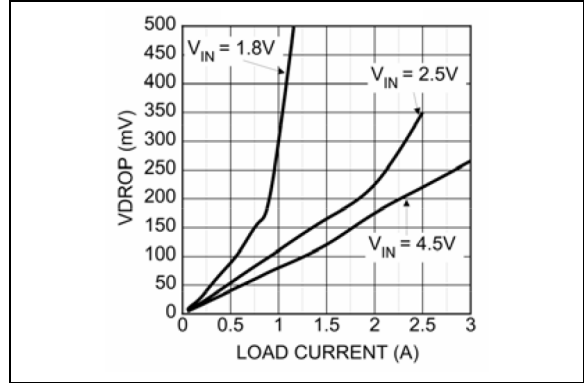

FIGURE 2-4: Voltage Drop vs. Load Current.

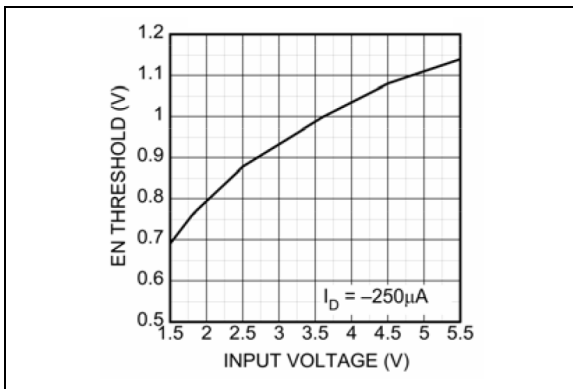

FIGURE 2-2: EN Threshold Voltage vs. Input Voltage.

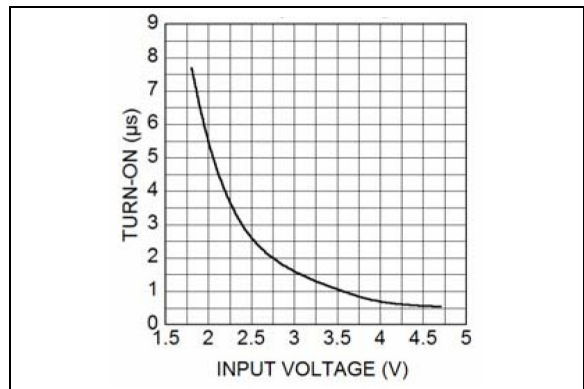

FIGURE 2-5: MIC94060/61 Turn-On Delay vs. Input Voltage.

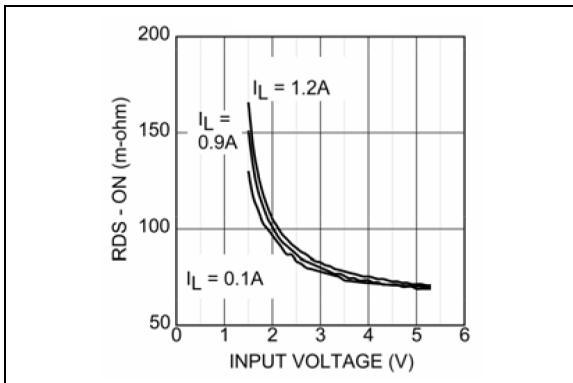

FIGURE 2-3: On-Resistance vs. Input Voltage.

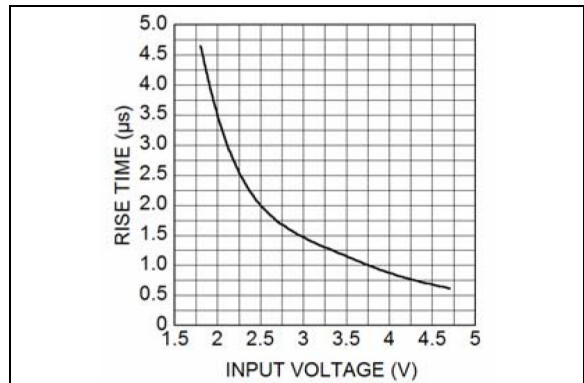

FIGURE 2-6: MIC94060/61 Rise Time vs. Input Voltage.

MIC94060/1/2/3

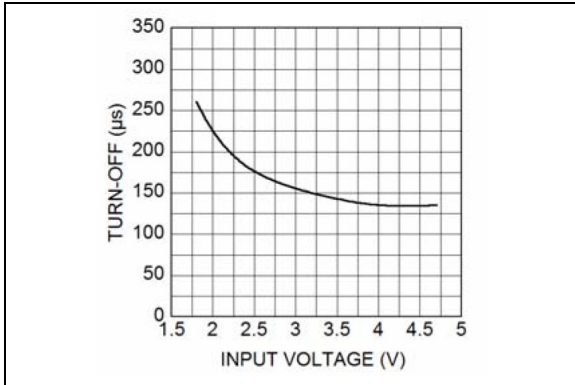

FIGURE 2-7: MIC94060/61 Turn-Off Delay vs. Input Voltage.

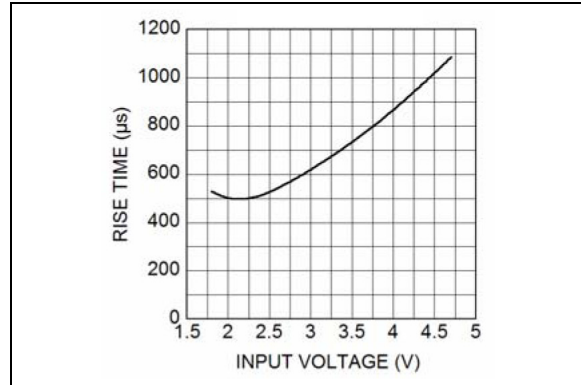

FIGURE 2-10: MIC94062/63 Rise Time vs. Input Voltage.

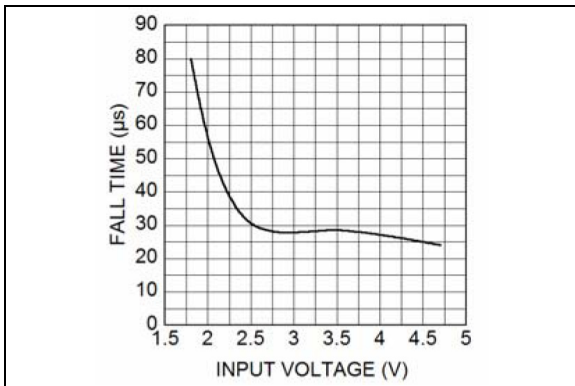

FIGURE 2-8: MIC94060/61 Fall Time vs. Input Voltage.

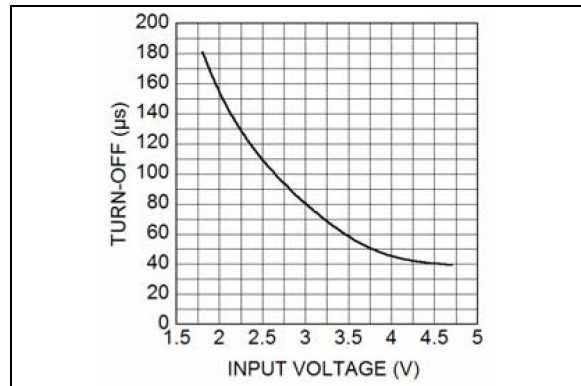

FIGURE 2-11: MIC94062/63 Turn-Off Delay vs. Input Voltage.

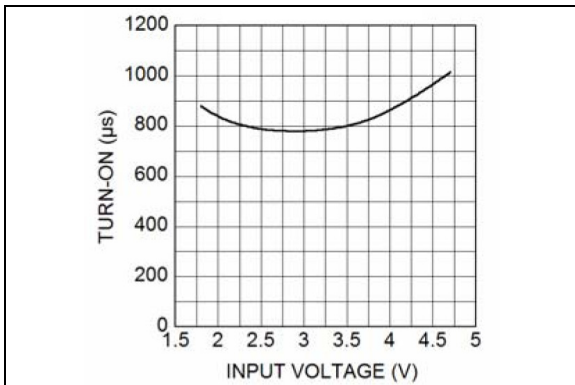

FIGURE 2-9: MIC94062/63 Turn-On Delay vs. Input Voltage.

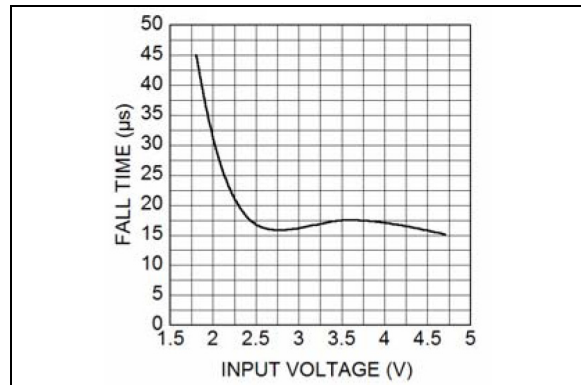

FIGURE 2-12: MIC94062/63 Fall Time vs. Input Voltage.

MIC94060

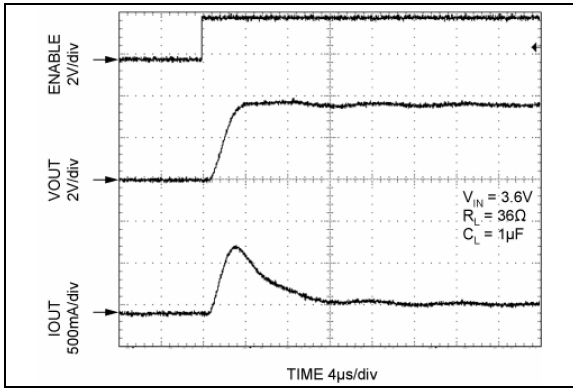

FIGURE 2-13: Turn-On/Turn-Off Timing.

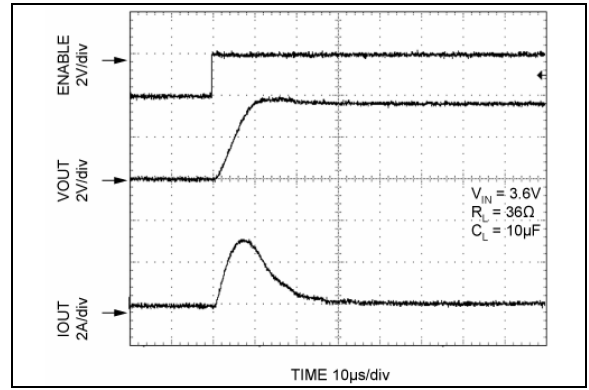

FIGURE 2-15: Turn-On/Turn-Off Timing.

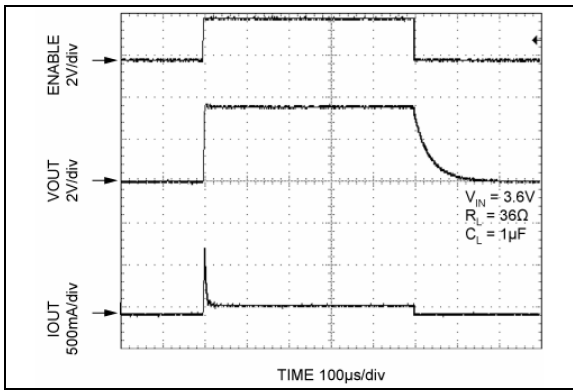

FIGURE 2-14: Turn-On/Turn-Off Timing.

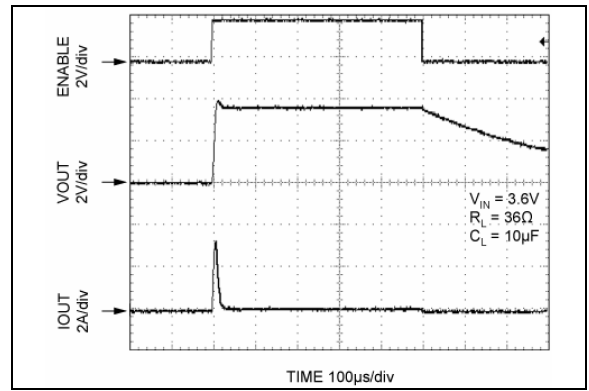

FIGURE 2-16: Turn-On/Turn-Off Timing.

MIC94060/1/2/3

MIC94061

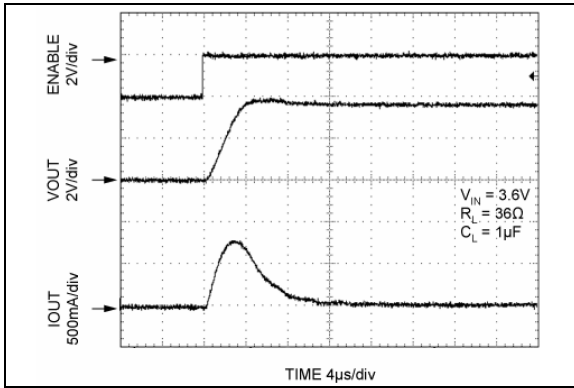

FIGURE 2-17: Turn-On/Turn-Off Timing.

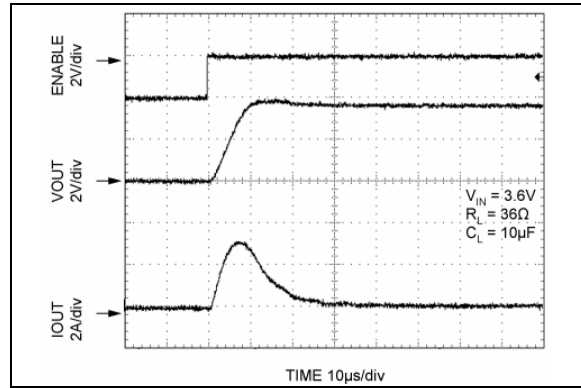

FIGURE 2-19: Turn-On/Turn-Off Timing.

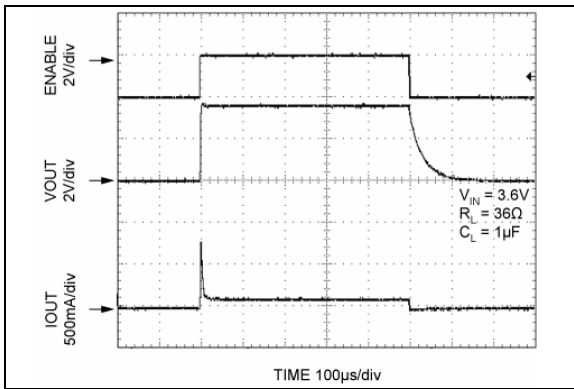

FIGURE 2-18: Turn-On/Turn-Off Timing.

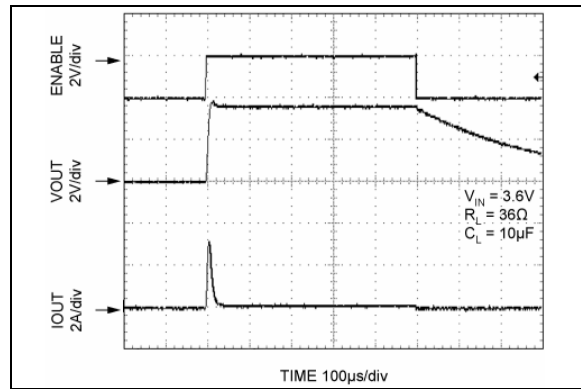

FIGURE 2-20: Turn-On/Turn-Off Timing.

MIC94062

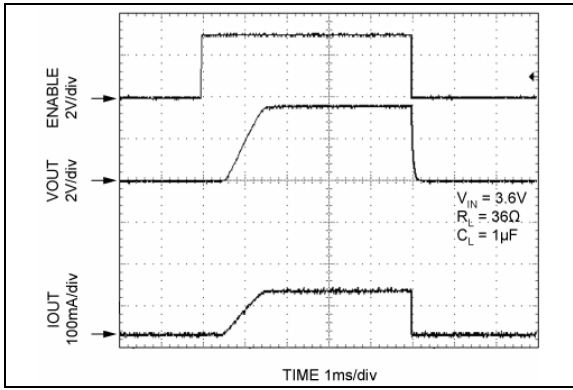

FIGURE 2-21: Turn-On/Turn-Off Timing.

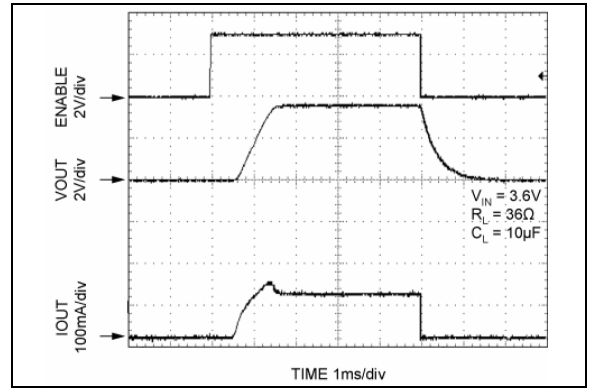

FIGURE 2-23: Turn-On/Turn-Off Timing.

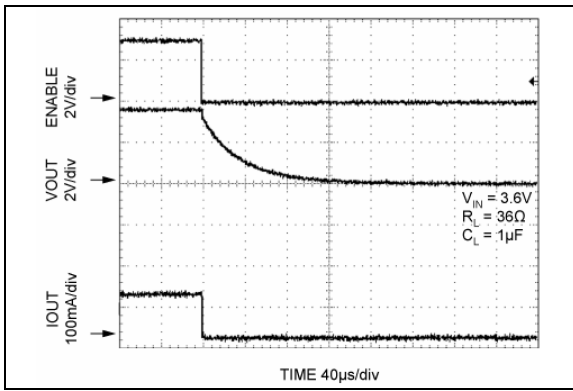

FIGURE 2-22: Turn-On/Turn-Off Timing.

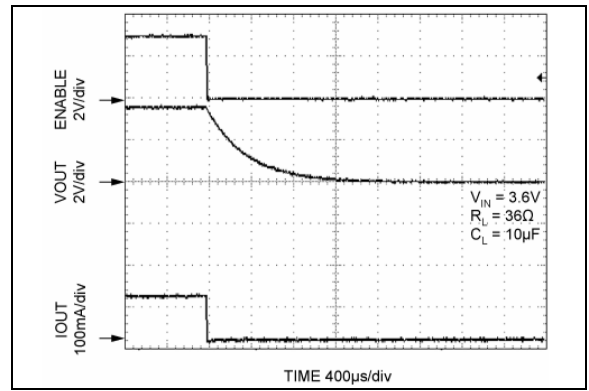

FIGURE 2-24: Turn-On/Turn-Off Timing.

MIC94060/1/2/3

MIC94063

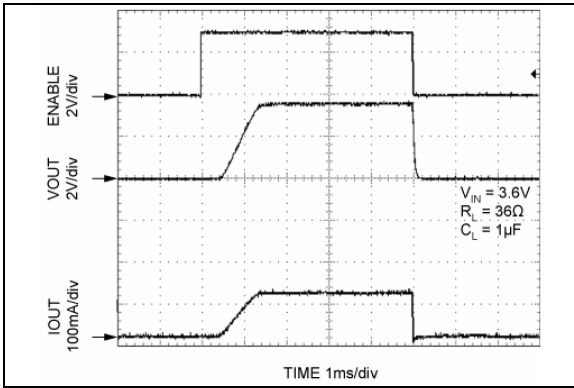

FIGURE 2-25: Turn-On/Turn-Off Timing.

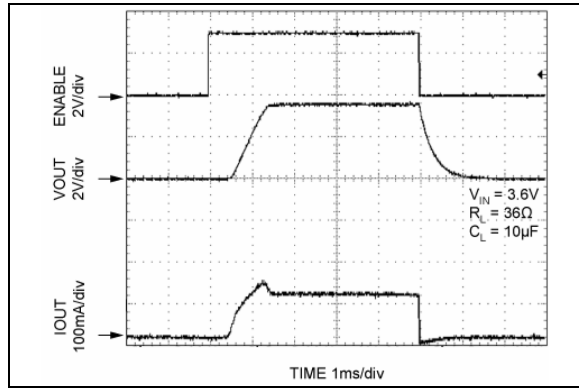

FIGURE 2-27: Turn-On/Turn-Off Timing.

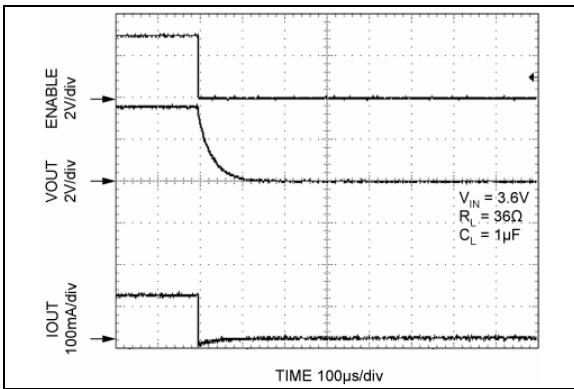

FIGURE 2-26: Turn-On/Turn-Off Timing.

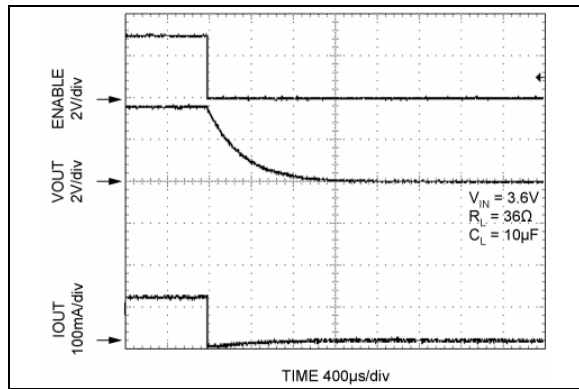

FIGURE 2-28: Turn-On/Turn-Off Timing.

3.0 PIN DESCRIPTIONS

The descriptions of the pins are listed in [Table 3-1](#).

TABLE 3-1: PIN FUNCTION TABLE

Pin Number SC-70	Pin Number UDFN	Pin Name	Description
1	1	VOUT	Drain of P-channel MOSFET.
2, 5	2	GND	Ground and the backside pad (UDFN only) should both be connected to electrical ground.
4	3	VIN	Source of P-channel MOSFET.
3	4	EN	Enable (Input): Active-high CMOS compatible control input for switch A. Do not leave floating.
6	—	NC	No Internal Connection. A signal or voltage applied to this pin will have no effect on device operation.

MIC94060/1/2/3

4.0 PACKAGING INFORMATION

4.1 Package Marking Information

6-Lead SC70*

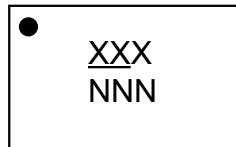

Example

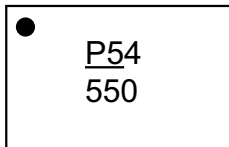

4-Lead UDFN*

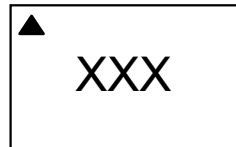

Example

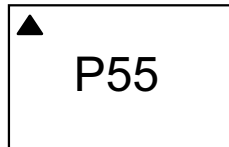

Legend:	XX...X	Product code or customer-specific information
	Y	Year code (last digit of calendar year)
	YY	Year code (last 2 digits of calendar year)
	WW	Week code (week of January 1 is week '01')
	NNN	Alphanumeric traceability code
	(e3)	Pb-free JEDEC® designator for Matte Tin (Sn)
	*	This package is Pb-free. The Pb-free JEDEC designator ((e3)) can be found on the outer packaging for this package.
	•, ▲, ▼	Pin one index is identified by a dot, delta up, or delta down (triangle mark).
Note:	In the event the full Microchip part number cannot be marked on one line, it will be carried over to the next line, thus limiting the number of available characters for customer-specific information. Package may or may not include the corporate logo.	
	Underbar () and/or Overbar () symbol may not be to scale.	

TABLE 4-1: MARKING CODES

Part Number	Marking Code	Soft-Start	Load Discharge
MIC94060YC6	<u>P54</u>	No	No
MIC94061YC6	<u>P55</u>	No	Yes
MIC94062YC6	<u>P56</u>	Yes	No
MIC94063YC6	<u>P57</u>	Yes	Yes
MIC94060YMT	P54	No	No
MIC94061YMT	P55	No	Yes
MIC94062YMT	P56	Yes	No
MIC94063YMT	P57	Yes	Yes

6-Lead SC-70 Package Outline & Recommended Land Pattern

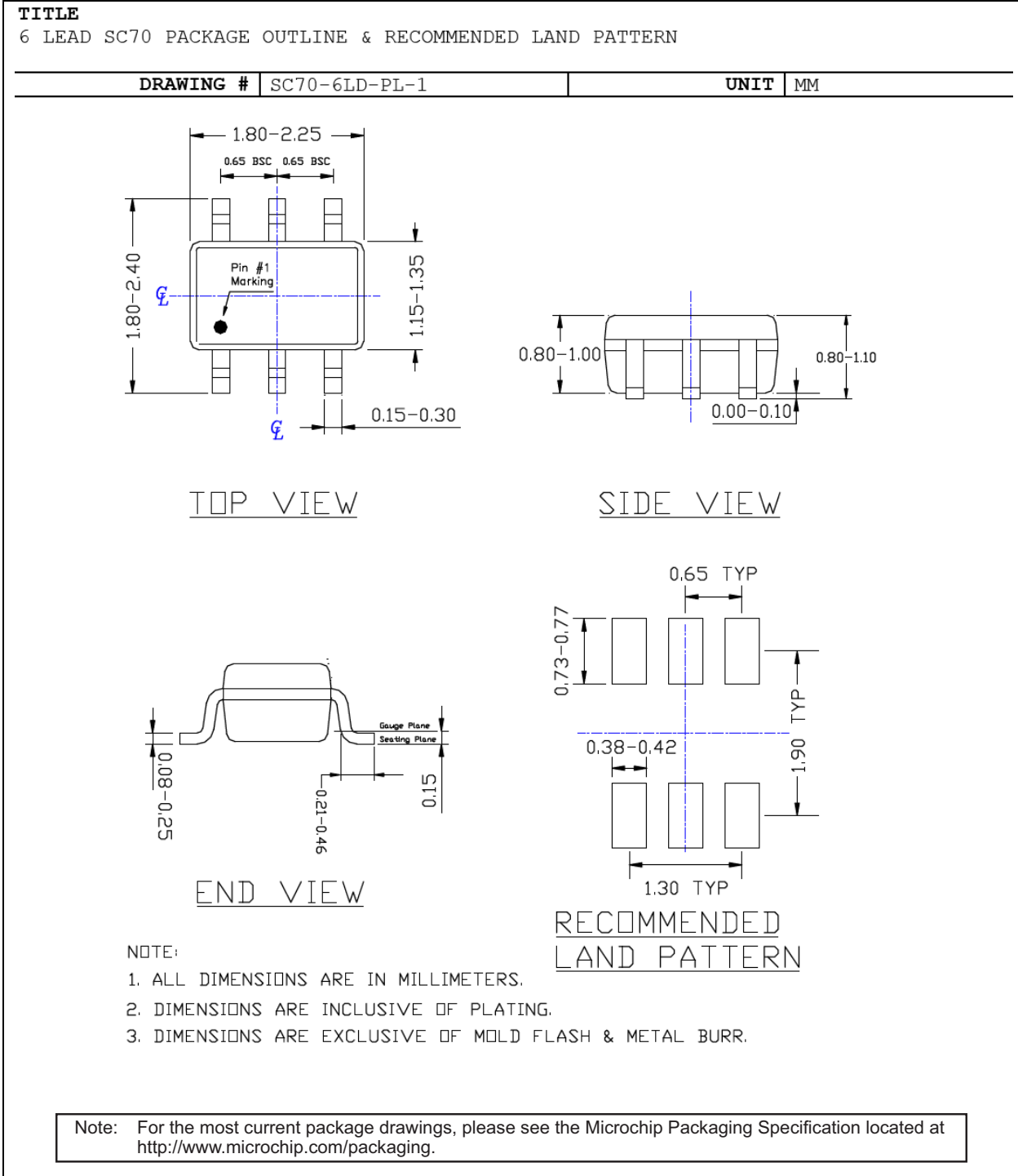

MIC94060/1/2/3

4-Lead UDFN Package Outline and Recommended Land Pattern

4-Lead Ultra Thin Dual Flat, No Lead Package (HGA) - 1.2x1.6x0.6 mm Body [UDFN] Micrel Legacy Package TMLF1216D-04L

Note: For the most current package drawings, please see the Microchip Packaging Specification located at <http://www.microchip.com/packaging>

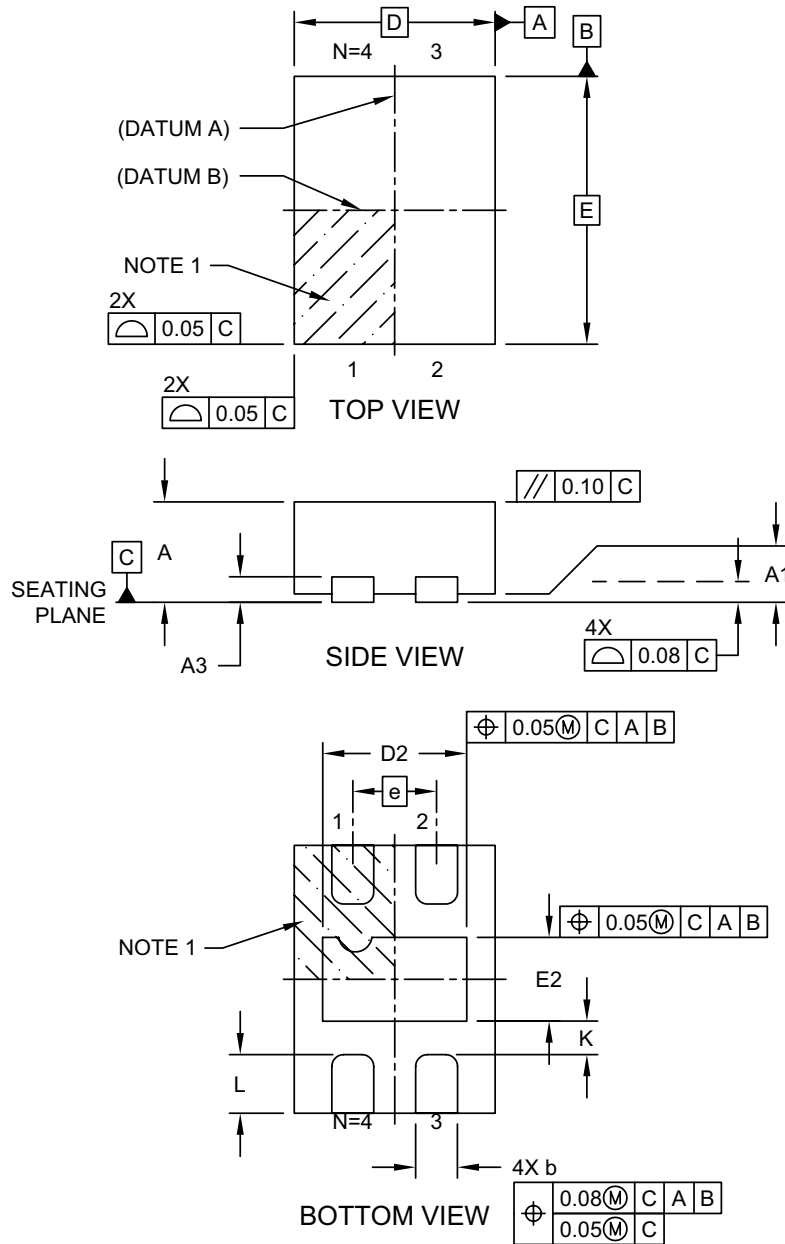

Microchip Technology Drawing C04-1152 Rev A Sheet 1 of 2

4-Lead Ultra Thin Dual Flat, No Lead Package (HGA) - 1.2x1.6x0.6 mm Body [UDFN] Micrel Legacy Package TMLF1216D-04L

Note: For the most current package drawings, please see the Microchip Packaging Specification located at <http://www.microchip.com/packaging>

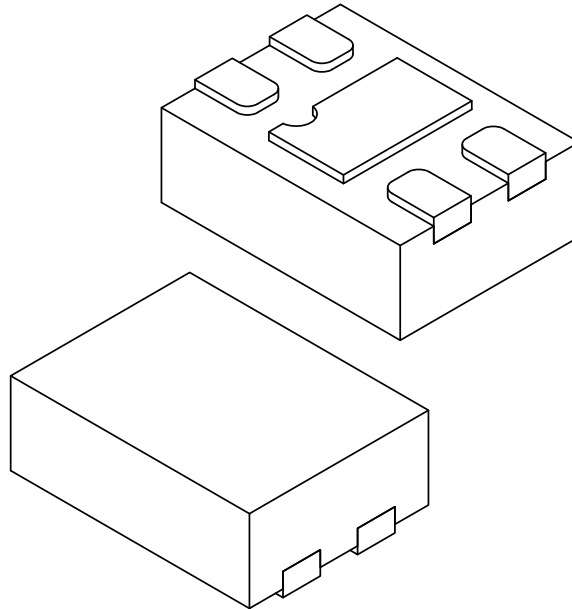

Dimension Limits	Units	MILLIMETERS		
		MIN	NOM	MAX
Number of Terminals	N	4		
Pitch	e	0.50 BSC		
Overall Height	A	0.50	0.55	0.60
Standoff	A1	0.00	0.02	0.05
Terminal Thickness	A3	0.152 REF		
Overall Length	D	1.20 BSC		
Exposed Pad Length	D2	0.81	0.86	0.91
Overall Width	E	1.60 BSC		
Exposed Pad Width	E2	0.45	0.50	0.55
Terminal Width	b	0.20	0.25	0.30
Terminal Length	L	0.30	0.35	0.40
Terminal-to-Exposed-Pad	K	0.20	-	-

Notes:

- Pin 1 visual index feature may vary, but must be located within the hatched area.
- Package is saw singulated
- Dimensioning and tolerancing per ASME Y14.5M
BSC: Basic Dimension. Theoretically exact value shown without tolerances.
REF: Reference Dimension, usually without tolerance, for information purposes only.

Microchip Technology Drawing C04-1152 Rev A Sheet 2 of 2

MIC94060/1/2/3

4-Lead Ultra Thin Dual Flat, No Lead Package (HGA) - 1.2x1.6x0.6 mm Body [UDFN] Micrel Legacy Package TMLF1216D-04L

Note: For the most current package drawings, please see the Microchip Packaging Specification located at <http://www.microchip.com/packaging>

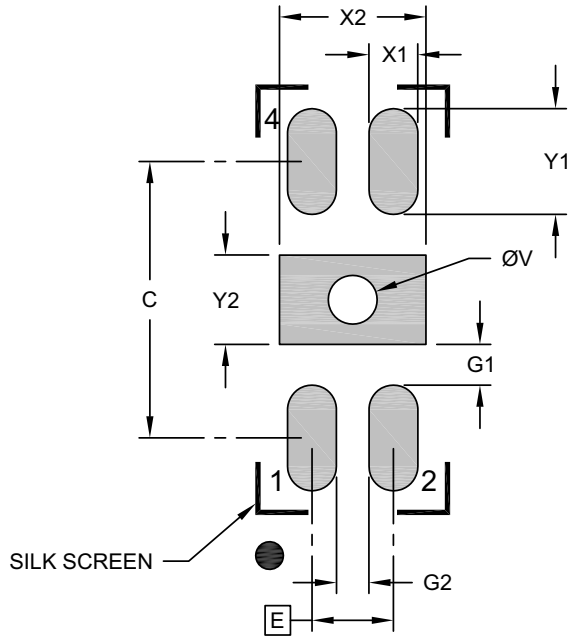

RECOMMENDED LAND PATTERN

Dimension Limits	Units	MILLIMETERS		
		MIN	NOM	MAX
Contact Pitch	E	0.50 BSC		
Optional Center Pad Width	X2			0.90
Optional Center Pad Length	Y2			0.55
Contact Pad Spacing	C		1.70	
Contact Pad Width (X4)	X1			0.30
Contact Pad Length (X4)	Y1			0.65
Contact Pad to Center Pad (X4)	G1	0.25		
Contact Pad to Contact Pad (X2)	G2	0.20		
Thermal Via Diameter	V		0.30	

Notes:

- Dimensioning and tolerancing per ASME Y14.5M
BSC: Basic Dimension. Theoretically exact value shown without tolerances.
- For best soldering results, thermal vias, if used, should be filled or tented to avoid solder loss during reflow process

Microchip Technology Drawing C04-3152 Rev A

APPENDIX A: REVISION HISTORY

Revision A (March 2021)

- Converted Micrel document MIC94060/1/2/3 to Microchip data sheet template DS20006517A.
- Minor grammatical text changes throughout.

MIC94060/1/2/3

NOTES:

PRODUCT IDENTIFICATION SYSTEM

To order or obtain information, e.g., on pricing or delivery, contact your local Microchip representative or sales office.

Device	<u>X</u>	<u>XX</u>	<u>-XX</u>	Examples:
Part No.	Junction Temp. Range	Package	Media Type	
Device:	MIC94060: MIC94061:	High Side Power Switch High Side Power Switch with Load Discharge		a) MIC94060YC6-TR: MIC94060, -40°C to +125°C Temperature Range, 6-Lead SC-70, 3,000/Reel
	MIC94062: MIC94063:	High Side Power Switch with Soft-Start High Side Power Switch with Soft-Start and Load Discharge		b) MIC94061YMT-TR: MIC94061, -40°C to +125°C Temperature Range, 4-Lead UDFN, 5,000/Reel
Junction Temperature Range:	Y =	-40°C to +125°C		c) MIC94062YC6-TR: MIC94062, -40°C to +125°C Temperature Range, 6-Lead SC-70, 3,000/Reel
Package:	C6 = MT =	6-Lead SC-70 4-Lead 1.6 mm x 1.2 mm UDFN		d) MIC94063YMT-TR: MIC94063, -40°C to +125°C Temperature Range, 4-Lead UDFN, 5,000/Reel
Media Type:	TR = TR =	3,000/Reel (SC-70 Package) 5,000/Reel (UDFN Package)		e) MIC94060YMT-TR: MIC94060, -40°C to +125°C Temperature Range, 4-Lead UDFN, 5,000/Reel
				f) MIC94061YC6-TR: MIC94061 -40°C to +125°C Temperature Range, 6-Lead SC-70, 3,000/Reel
				Note 1: Tape and Reel identifier only appears in the catalog part number description. This identifier is used for ordering purposes and is not printed on the device package. Check with your Microchip Sales Office for package availability with the Tape and Reel option.

MIC94060/1/2/3

NOTES:

Note the following details of the code protection feature on Microchip devices:

- Microchip products meet the specifications contained in their particular Microchip Data Sheet.
- Microchip believes that its family of products is secure when used in the intended manner and under normal conditions.
- There are dishonest and possibly illegal methods being used in attempts to breach the code protection features of the Microchip devices. We believe that these methods require using the Microchip products in a manner outside the operating specifications contained in Microchip's Data Sheets. Attempts to breach these code protection features, most likely, cannot be accomplished without violating Microchip's intellectual property rights.
- Microchip is willing to work with any customer who is concerned about the integrity of its code.
- Neither Microchip nor any other semiconductor manufacturer can guarantee the security of its code. Code protection does not mean that we are guaranteeing the product is "unbreakable." Code protection is constantly evolving. We at Microchip are committed to continuously improving the code protection features of our products. Attempts to break Microchip's code protection feature may be a violation of the Digital Millennium Copyright Act. If such acts allow unauthorized access to your software or other copyrighted work, you may have a right to sue for relief under that Act.

Information contained in this publication is provided for the sole purpose of designing with and using Microchip products. Information regarding device applications and the like is provided only for your convenience and may be superseded by updates. It is your responsibility to ensure that your application meets with your specifications.

THIS INFORMATION IS PROVIDED BY MICROCHIP "AS IS". MICROCHIP MAKES NO REPRESENTATIONS OR WARRANTIES OF ANY KIND WHETHER EXPRESS OR IMPLIED, WRITTEN OR ORAL, STATUTORY OR OTHERWISE, RELATED TO THE INFORMATION INCLUDING BUT NOT LIMITED TO ANY IMPLIED WARRANTIES OF NON-INFRINGEMENT, MERCHANTABILITY, AND FITNESS FOR A PARTICULAR PURPOSE OR WARRANTIES RELATED TO ITS CONDITION, QUALITY, OR PERFORMANCE.

IN NO EVENT WILL MICROCHIP BE LIABLE FOR ANY INDIRECT, SPECIAL, PUNITIVE, INCIDENTAL OR CONSEQUENTIAL LOSS, DAMAGE, COST OR EXPENSE OF ANY KIND WHATSOEVER RELATED TO THE INFORMATION OR ITS USE, HOWEVER CAUSED, EVEN IF MICROCHIP HAS BEEN ADVISED OF THE POSSIBILITY OR THE DAMAGES ARE FORESEEABLE. TO THE FULLEST EXTENT ALLOWED BY LAW, MICROCHIP'S TOTAL LIABILITY ON ALL CLAIMS IN ANY WAY RELATED TO THE INFORMATION OR ITS USE WILL NOT EXCEED THE AMOUNT OF FEES, IF ANY, THAT YOU HAVE PAID DIRECTLY TO MICROCHIP FOR THE INFORMATION. Use of Microchip devices in life support and/or safety applications is entirely at the buyer's risk, and the buyer agrees to defend, indemnify and hold harmless Microchip from any and all damages, claims, suits, or expenses resulting from such use. No licenses are conveyed, implicitly or otherwise, under any Microchip intellectual property rights unless otherwise stated.

Trademarks

The Microchip name and logo, the Microchip logo, Adaptec, AnyRate, AVR, AVR logo, AVR Freaks, BesTime, BitCloud, chipKIT, chipKIT logo, CryptoMemory, CryptoRF, dsPIC, FlashFlex, flexPWR, HELDO, IGL00, JukeBlox, KeeLoq, Kleer, LANCheck, LinkMD, maXStylus, maXTouch, MediaLB, megaAVR, Microsemi, Microsemi logo, MOST, MOST logo, MPLAB, OptoLyzer, PackeTime, PIC, picoPower, PICSTART, PIC32 logo, PolarFire, Prochip Designer, QTouch, SAM-BA, SenGenuity, SpyNIC, SST, SST Logo, SuperFlash, Symmetricom, SyncServer, Tachyon, TimeSource, tinyAVR, UNI/O, Vectron, and XMEGA are registered trademarks of Microchip Technology Incorporated in the U.S.A. and other countries.

AgileSwitch, APT, ClockWorks, The Embedded Control Solutions Company, EtherSynch, FlashTec, Hyper Speed Control, HyperLight Load, IntelliMOS, Libero, motorBench, mTouch, Powermite 3, Precision Edge, ProASIC, ProASIC Plus, ProASIC Plus logo, Quiet-Wire, SmartFusion, SyncWorld, Temux, TimeCesium, TimeHub, TimePictra, TimeProvider, WinPath, and ZL are registered trademarks of Microchip Technology Incorporated in the U.S.A.

Adjacent Key Suppression, AKS, Analog-for-the-Digital Age, Any Capacitor, AnyIn, AnyOut, Augmented Switching, BlueSky, BodyCom, CodeGuard, CryptoAuthentication, CryptoAutomotive, CryptoCompanion, CryptoController, dsPICDEM, dsPICDEM.net, Dynamic Average Matching, DAM, ECAN, Espresso T1S, EtherGREEN, IdealBridge, In-Circuit Serial Programming, ICSP, INICnet, Intelligent Paralleling, Inter-Chip Connectivity, JitterBlocker, maxCrypto, maxView, memBrain, Mindi, MiWi, MPASM, MPF, MPLAB Certified logo, MPLIB, MPLINK, MultiTRAK, NetDetach, Omniscient Code Generation, PICDEM, PICDEM.net, PICkit, PICtail, PowerSmart, PureSilicon, QMatrix, REAL ICE, Ripple Blocker, RTAX, RTG4, SAM-ICE, Serial Quad I/O, simpleMAP, SimpliPHY, SmartBuffer, SMART-I.S., storClad, SQI, SuperSwitcher, SuperSwitcher II, Switchtec, SynchroPHY, Total Endurance, TSHARC, USBCheck, VariSense, VectorBlox, VeriPHY, ViewSpan, WiperLock, XpressConnect, and ZENA are trademarks of Microchip Technology Incorporated in the U.S.A. and other countries.

SQTP is a service mark of Microchip Technology Incorporated in the U.S.A.

The Adaptec logo, Frequency on Demand, Silicon Storage Technology, and Symmcom are registered trademarks of Microchip Technology Inc. in other countries.

GestIC is a registered trademark of Microchip Technology Germany II GmbH & Co. KG, a subsidiary of Microchip Technology Inc., in other countries.

All other trademarks mentioned herein are property of their respective companies.

© 2021, Microchip Technology Incorporated, All Rights Reserved.

ISBN: 978-1-5224-7982-6

For information regarding Microchip's Quality Management Systems, please visit www.microchip.com/quality.



MICROCHIP

Worldwide Sales and Service

AMERICAS

Corporate Office
2355 West Chandler Blvd.
Chandler, AZ 85224-6199
Tel: 480-792-7200
Fax: 480-792-7277
Technical Support:
[http://www.microchip.com/
support](http://www.microchip.com/support)
Web Address:
www.microchip.com

Atlanta

Duluth, GA
Tel: 678-957-9614
Fax: 678-957-1455

Austin, TX

Tel: 512-257-3370

Boston

Westborough, MA
Tel: 774-760-0087
Fax: 774-760-0088

Chicago

Itasca, IL
Tel: 630-285-0071
Fax: 630-285-0075

Dallas

Addison, TX
Tel: 972-818-7423
Fax: 972-818-2924

Detroit

Novi, MI
Tel: 248-848-4000

Houston, TX

Tel: 281-894-5983

Indianapolis

Noblesville, IN
Tel: 317-773-8323
Fax: 317-773-5453
Tel: 317-536-2380

Los Angeles

Mission Viejo, CA
Tel: 949-462-9523
Fax: 949-462-9608
Tel: 951-273-7800

Raleigh, NC

Tel: 919-844-7510

New York, NY

Tel: 631-435-6000

San Jose, CA

Tel: 408-735-9110
Tel: 408-436-4270

Canada - Toronto

Tel: 905-695-1980
Fax: 905-695-2078

ASIA/PACIFIC

Australia - Sydney
Tel: 61-2-9868-6733

China - Beijing
Tel: 86-10-8569-7000

China - Chengdu
Tel: 86-28-8665-5511

China - Chongqing
Tel: 86-23-8980-9588

China - Dongguan
Tel: 86-769-8702-9880

China - Guangzhou
Tel: 86-20-8755-8029

China - Hangzhou
Tel: 86-571-8792-8115

China - Hong Kong SAR
Tel: 852-2943-5100

China - Nanjing
Tel: 86-25-8473-2460

China - Qingdao
Tel: 86-532-8502-7355

China - Shanghai
Tel: 86-21-3326-8000

China - Shenyang
Tel: 86-24-2334-2829

China - Shenzhen
Tel: 86-755-8864-2200

China - Suzhou
Tel: 86-186-6233-1526

China - Wuhan
Tel: 86-27-5980-5300

China - Xian
Tel: 86-29-8833-7252

China - Xiamen
Tel: 86-592-2388138

China - Zhuhai
Tel: 86-756-3210040

ASIA/PACIFIC

India - Bangalore
Tel: 91-80-3090-4444

India - New Delhi
Tel: 91-11-4160-8631

India - Pune
Tel: 91-20-4121-0141

Japan - Osaka
Tel: 81-6-6152-7160

Japan - Tokyo
Tel: 81-3-6880-3770

Korea - Daegu
Tel: 82-53-744-4301

Korea - Seoul
Tel: 82-2-554-7200

Malaysia - Kuala Lumpur
Tel: 60-3-7651-7906

Malaysia - Penang
Tel: 60-4-227-8870

Philippines - Manila
Tel: 63-2-634-9065

Singapore
Tel: 65-6334-8870

Taiwan - Hsin Chu
Tel: 886-3-577-8366

Taiwan - Kaohsiung
Tel: 886-7-213-7830

Taiwan - Taipei
Tel: 886-2-2508-8600

Thailand - Bangkok
Tel: 66-2-694-1351

Vietnam - Ho Chi Minh
Tel: 84-28-5448-2100

EUROPE

Austria - Wels
Tel: 43-7242-2244-39
Fax: 43-7242-2244-393

Denmark - Copenhagen
Tel: 45-4485-5910
Fax: 45-4485-2829

Finland - Espoo
Tel: 358-9-4520-820

France - Paris
Tel: 33-1-69-53-63-20
Fax: 33-1-69-30-90-79

Germany - Garching
Tel: 49-8931-9700

Germany - Haan
Tel: 49-2129-3766400

Germany - Heilbronn
Tel: 49-7131-72400

Germany - Karlsruhe
Tel: 49-721-625370

Germany - Munich
Tel: 49-89-627-144-0
Fax: 49-89-627-144-44

Germany - Rosenheim
Tel: 49-8031-354-560

Israel - Ra'anana
Tel: 972-9-744-7705

Italy - Milan
Tel: 39-0331-742611
Fax: 39-0331-466781

Italy - Padova
Tel: 39-049-7625286

Netherlands - Drunen
Tel: 31-416-690399
Fax: 31-416-690340

Norway - Trondheim
Tel: 47-7288-4388

Poland - Warsaw
Tel: 48-22-3325737

Romania - Bucharest
Tel: 40-21-407-87-50

Spain - Madrid
Tel: 34-91-708-08-90
Fax: 34-91-708-08-91

Sweden - Gothenberg
Tel: 46-31-704-60-40

Sweden - Stockholm
Tel: 46-8-5090-4654

UK - Wokingham
Tel: 44-118-921-5800
Fax: 44-118-921-5820