

## 28V, 12A Hyper Speed Control<sup>®</sup> Synchronous DC/DC Buck Regulator

### Features

- Hyper Speed Control<sup>®</sup> Architecture Enables
  - High Delta V Operation ( $V_{IN} = 28V$  and  $V_{OUT} = 0.8V$ )
  - Small Output Capacitance
- 4.5V to 28V Voltage Input
- 12A Output Current Capability, Up to 95% Efficiency
- Adjustable Output from 0.8V to 5.5V
- $\pm 1\%$  Feedback Accuracy
- Any Capacitor<sup>™</sup> Stable: Zero ESR to High ESR
- 600 kHz Switching Frequency
- No External Compensation
- Power Good (PG) Output
- Foldback Current Limit and “Hiccup Mode” Short-Circuit Protection
- Supports Safe Startup into a Pre-Biased Load
- $-40^{\circ}C$  to  $+125^{\circ}C$  Junction Temperature Range
- 28-Lead 5 mm x 6 mm VQFN Package

### Applications

- Distributed Power Systems
- Communications/Networking Infrastructure
- Set-Top Box, Gateways, and Routers
- Printers, Scanners, Graphic Cards, and Video Cards

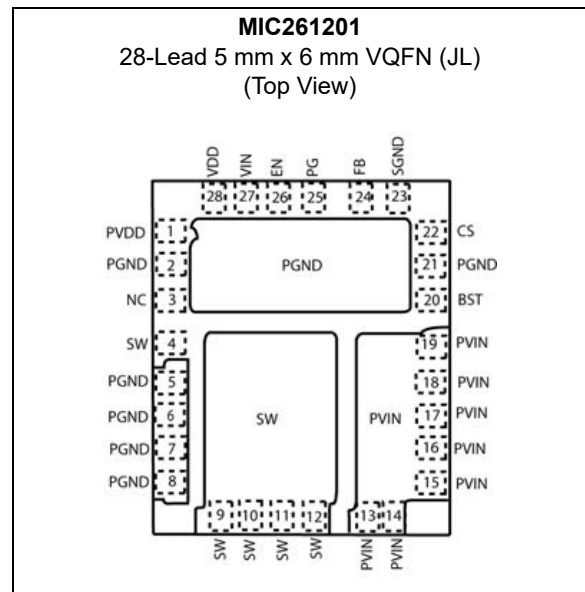
### General Description

The MIC261201 is a constant-frequency, synchronous buck regulator that features a unique adaptive on-time control architecture. The MIC261201 operates over an input supply range of 4.5V to 28V and provides a regulated output of up to 12A of output current. The output voltage is adjustable down to 0.8V with an ensured accuracy of  $\pm 1\%$ , and the device operates at a switching frequency of 600 kHz.

Microchip’s Hyper Speed Control<sup>®</sup> architecture allows for ultra-fast transient response while reducing the output capacitance and also makes (High  $V_{IN}$ )/(Low  $V_{OUT}$ ) operation possible. This adaptive  $t_{ON}$  ripple control architecture combines the advantages of fixed-frequency operation and fast transient response in a single device.

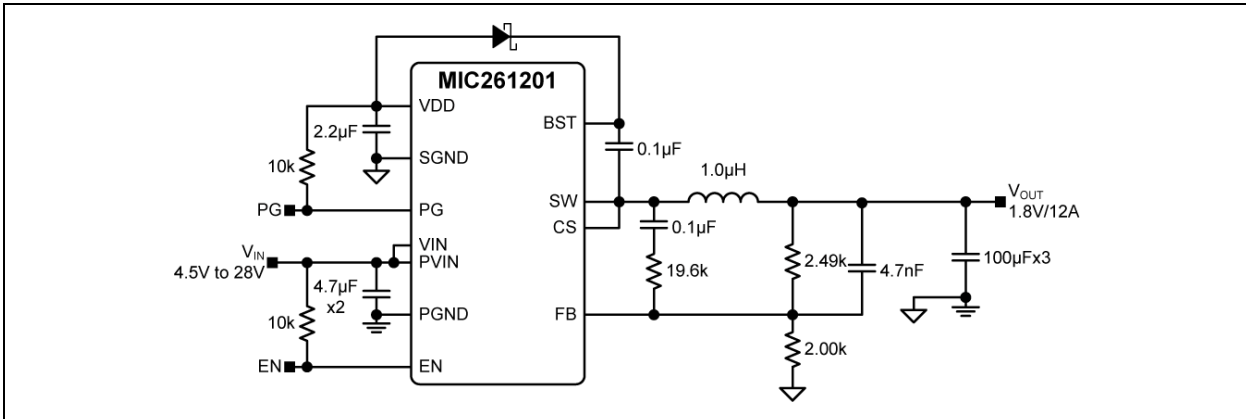
The MIC261201 offers a full suite of features to protect the IC during fault conditions. These include undervoltage lockout to ensure proper operation under power-sag conditions, internal soft-start to reduce inrush current, foldback current limit, “hiccup mode” short-circuit protection, and thermal shutdown. An open-drain Power Good (PG) pin is provided.

### Package Type

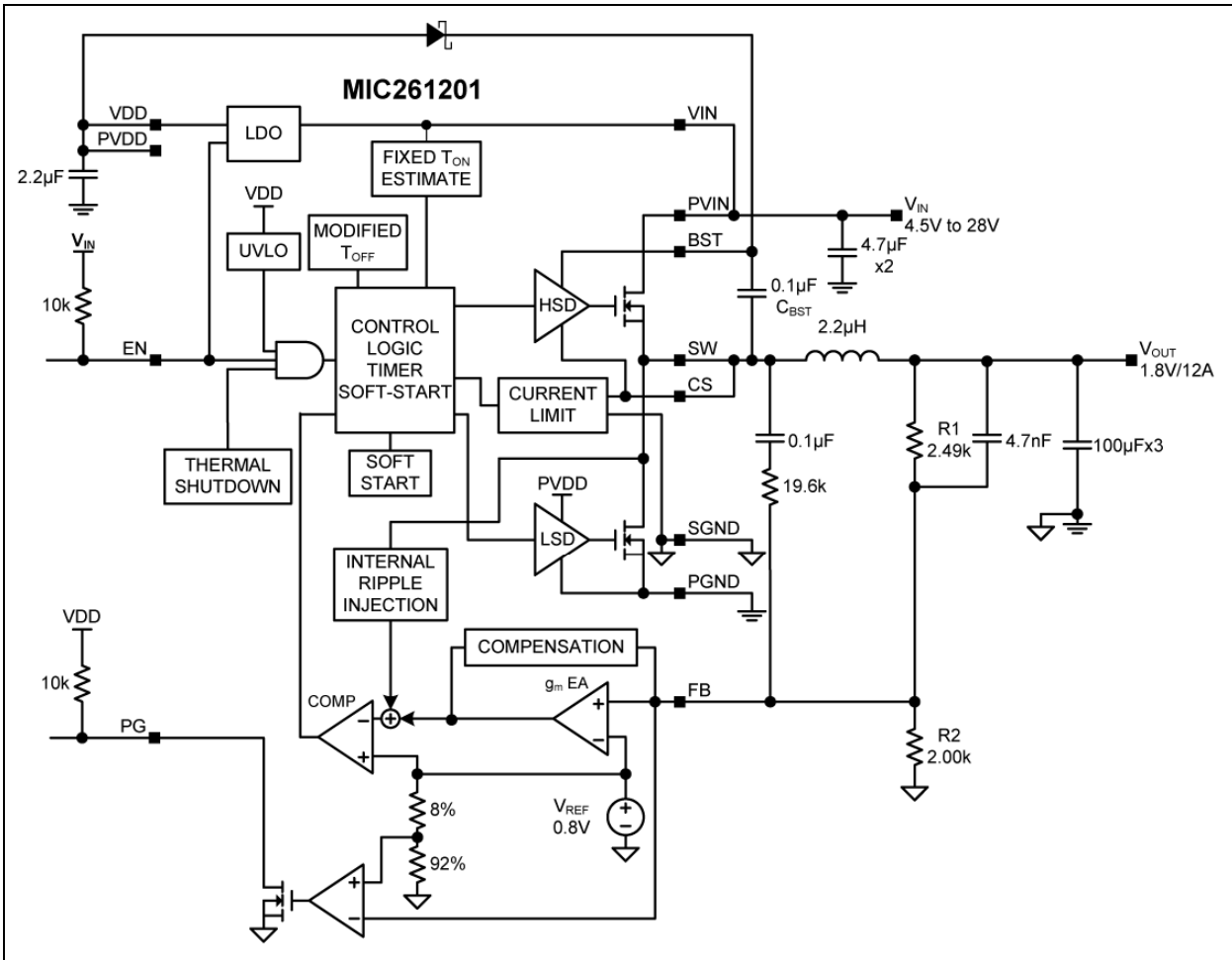


# MIC261201

## Typical Application Circuit



## Functional Block Diagram



## 1.0 ELECTRICAL CHARACTERISTICS

### Absolute Maximum Ratings †

PV <sub>IN</sub> to PGND	-0.3V to +29V
V <sub>IN</sub> to PGND	-0.3V to PV <sub>IN</sub>
PV <sub>DD</sub> , V <sub>DD</sub> to PGND	-0.3V to +6V
V <sub>SW</sub> , V <sub>CS</sub> to PGND	-0.3V to (PV <sub>IN</sub> + 0.3V)
V <sub>BST</sub> to V <sub>SW</sub>	-0.3V to +6V
V <sub>BST</sub> to PGND	-0.3V to +35V
V <sub>FB</sub> , V <sub>PG</sub> to PGND	-0.3V to (V <sub>DD</sub> + 0.3V)
V <sub>EN</sub> to PGND	-0.3V to (V <sub>IN</sub> + 0.3V)
PGND to SGND	-0.3V to +0.3V

### Operating Ratings ‡

Supply Voltage (PV <sub>IN</sub> , V <sub>IN</sub> )	+4.5V to +28V
PV <sub>DD</sub> , V <sub>DD</sub> Supply Voltage (PV <sub>DD</sub> , V <sub>DD</sub> )	+4.5V to +5.5V
Enable Input (V <sub>EN</sub> )	0V to V <sub>IN</sub>
Maximum Power Dissipation	Note 1

† **Notice:** Stresses above those listed under “Absolute Maximum Ratings” may cause permanent damage to the device. This is a stress rating only and functional operation of the device at those or any other conditions above those indicated in the operational sections of this specification is not intended. Exposure to maximum rating conditions for extended periods may affect device reliability. Devices are ESD sensitive. Handling precautions recommended. Human body model, 1.5 kΩ in series with 100 pF.

‡ **Notice:** The device is not guaranteed to function outside its operating ratings.

**Note 1:**  $P_{D(MAX)} = (T_{J(MAX)} - T_A)/\theta_{JA}$ , where  $\theta_{JA}$  depends upon the printed circuit layout. A 5 square inch 4 layer, 0.62”, FR-4 PCB with 2 oz. finish copper weight per layer is used for the  $\theta_{JA}$ .

## ELECTRICAL CHARACTERISTICS

**Electrical Characteristics:** PV<sub>IN</sub> = V<sub>IN</sub> = V<sub>EN</sub> = 12V, V<sub>BST</sub> - V<sub>SW</sub> = 5V; T<sub>A</sub> = +25°C, unless noted. **Bold** values valid for -40°C ≤ T<sub>J</sub> ≤ +125°C. (Note 1)

Parameter	Symbol	Min.	Typ.	Max.	Units	Conditions
<b>Power Supply Input</b>						
Input Voltage Range	V <sub>IN</sub> , PV <sub>IN</sub>	<b>4.5</b>	—	<b>28</b>	V	—
Quiescent Supply Current	I <sub>Q</sub>	—	730	<b>1500</b>	μA	V <sub>FB</sub> = 1.5V (non-switching)
Shutdown Supply Current	I <sub>SHDN</sub>	—	5	<b>10</b>	μA	V <sub>EN</sub> = 0V
<b>V<sub>DD</sub> Supply Voltage</b>						
VDD Output Voltage	V <sub>OUT</sub>	<b>4.8</b>	5	<b>5.4</b>	V	V <sub>IN</sub> = 7V to 28V, I <sub>DD</sub> = 40 mA
VDD UVLO Threshold	UVLO <sub>TH</sub>	<b>3.7</b>	4.2	<b>4.5</b>	V	V <sub>DD</sub> Rising
VDD UVLO Hysteresis	UVLO <sub>HYS</sub>	—	400	—	mV	—
Dropout Voltage	V <sub>DO</sub>	—	380	<b>600</b>	mV	(V <sub>IN</sub> - V <sub>DD</sub> ), I <sub>DD</sub> = 25 mA
<b>DC/DC Controller</b>						
Output-Voltage Adjust Range	V <sub>OUT</sub>	0.8	—	<b>5.5</b>	V	—
<b>Reference</b>						
Feedback Voltage	V <sub>FB</sub>	<b>0.792</b>	0.8	<b>0.808</b>	V	0°C ≤ T <sub>J</sub> ≤ +85°C (±1.5%)
		<b>0.788</b>	0.8	<b>0.812</b>		-40°C ≤ T <sub>J</sub> ≤ +125°C (±2.0%)
Load Regulation	—	—	0.25	—	%	I <sub>OUT</sub> = 0A to 12A (Continuous Mode)
Line Regulation	—	—	0.25	—	%	V <sub>IN</sub> = 4.5V to 28V

# MIC261201

## ELECTRICAL CHARACTERISTICS (CONTINUED)

**Electrical Characteristics:**  $PV_{IN} = V_{IN} = V_{EN} = 12V$ ,  $V_{BST} - V_{SW} = 5V$ ;  $T_A = +25^\circ C$ , unless noted. **Bold** values valid for  $-40^\circ C \leq T_J \leq +125^\circ C$ . (Note 1)

Parameter	Symbol	Min.	Typ.	Max.	Units	Conditions
FB Bias Current	$I_{FB}$	—	50	—	nA	$V_{FB} = 0.8V$
<b>Enable Control</b>						
EN Logic Level High	—	<b>1.8</b>	—	—	V	—
EN Logic Level Low	—	—	—	<b>0.6</b>	V	—
EN Bias Current	$I_{EN}$	—	6	<b>30</b>	$\mu A$	$V_{EN} = 12V$
<b>Oscillator</b>						
Switching Frequency	$f_{SW}$	<b>450</b>	600	<b>750</b>	kHz	Note 2, $V_{FB} = 0V$
Maximum Duty Cycle	$DC_{MAX}$	—	82	—	%	Note 3, $V_{FB} = 1.0V$
Minimum Duty Cycle	$DC_{MIN}$	—	0	—	%	—
Minimum Off-Time	$t_{OFF(MIN)}$	—	300	—	ns	—
<b>Soft-Start</b>						
Soft-Start Time	$t_{SS}$	—	5	—	ms	—
<b>Short-Circuit Protection</b>						
Current Limit Threshold	$I_{LIM(TH)}$	18.75	26	37	A	$V_{FB} = 0.8V$ , $T_J = +25^\circ C$
		17.36	26	37	A	$V_{FB} = 0.8V$ , $T_J = +125^\circ C$
Short-Circuit Current	$I_{SC}$	—	6	—	A	$V_{FB} = 0V$
<b>Internal FETs</b>						
Top MOSFET $R_{DS(ON)}$	—	—	13	—	m $\Omega$	$I_{SW} = 3A$
Bottom MOSFET $R_{DS(ON)}$	—	—	5.3	—	m $\Omega$	$I_{SW} = 3A$
SW Leakage Current	—	—	—	<b>60</b>	$\mu A$	$V_{EN} = 0V$
$V_{IN}$ Leakage Current	—	—	—	<b>25</b>	$\mu A$	$V_{EN} = 0V$
<b>Power Good (PG)</b>						
PG Threshold Voltage	—	<b>85</b>	92	<b>95</b>	% $V_{OUT}$	Sweep $V_{FB}$ from Low to High
PG Hysteresis	—	—	5.5	—	% $V_{OUT}$	Sweep $V_{FB}$ from High to Low
PG Delay Time	—	—	100	—	$\mu s$	Sweep $V_{FB}$ from Low to High
PG Low Voltage	—	—	70	<b>200</b>	mV	Sweep $V_{FB} < 0.9 \times V_{NOM}$ , $I_{PG} = 1 mA$
<b>Thermal Protection</b>						
Overtemperature Shutdown	—	—	160	—	$^\circ C$	$T_J$ rising
Overtemperature Shutdown Hysteresis	—	—	15	—	$^\circ C$	—

**Note 1:** Specifications are for packaged products only.

**2:** Measured in test mode.

**3:** The maximum duty cycle is limited by the fixed mandatory off-time ( $t_{OFF}$ ) of typically 300 ns.

## TEMPERATURE SPECIFICATIONS

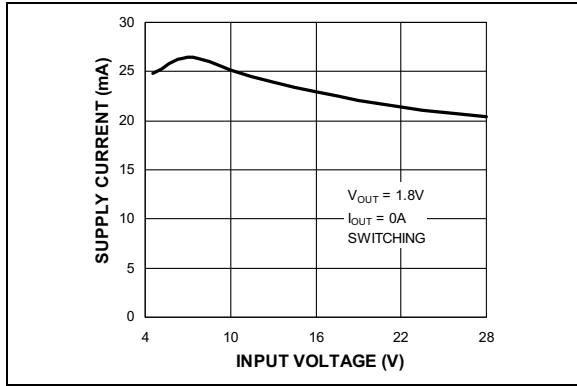
Parameters	Sym.	Min.	Typ.	Max.	Units	Conditions
<b>Temperature Ranges</b>						
Max. Junction Temperature	$T_{J(MAX)}$	—	—	+150	°C	—
Storage Temperature Range	$T_S$	-65	—	+150	°C	—
Lead Temperature	$T_{LEAD}$	—	—	+260	°C	Soldering, 10 sec.
Junction Temperature Range	$T_J$	-40	—	+125	°C	—
<b>Package Thermal Resistances</b>						
Thermal Resistance, VQFN 28-Ld	$\theta_{JA}$	—	28	—	°C/W	—

**Note 1:** The maximum allowable power dissipation is a function of ambient temperature, the maximum allowable junction temperature and the thermal resistance from junction to air (i.e.,  $T_A$ ,  $T_J$ ,  $\theta_{JA}$ ). Exceeding the maximum allowable power dissipation will cause the device operating junction temperature to exceed the maximum +125°C rating. Sustained junction temperatures above +125°C can impact the device reliability.

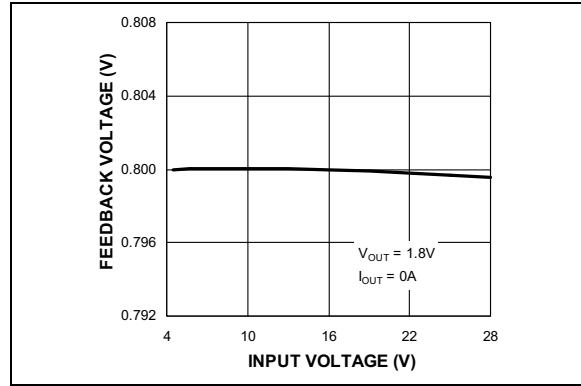
# MIC261201

## 2.0 TYPICAL PERFORMANCE CURVES

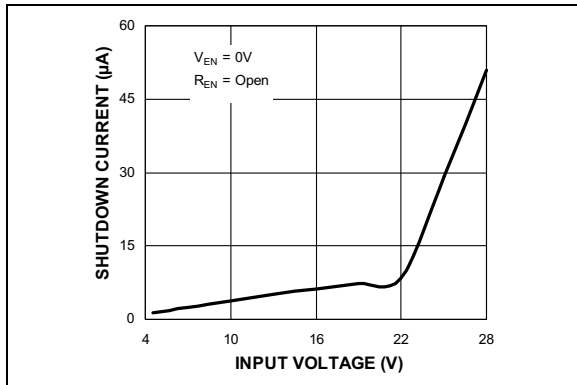
**Note:** The graphs and tables provided following this note are a statistical summary based on a limited number of samples and are provided for informational purposes only. The performance characteristics listed herein are not tested or guaranteed. In some graphs or tables, the data presented may be outside the specified operating range (e.g., outside specified power supply range) and therefore outside the warranted range.



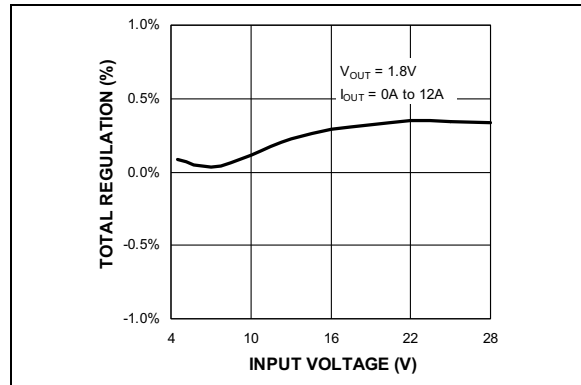
**FIGURE 2-1:**  $V_{IN}$  Operating Supply Current vs. Input Voltage.



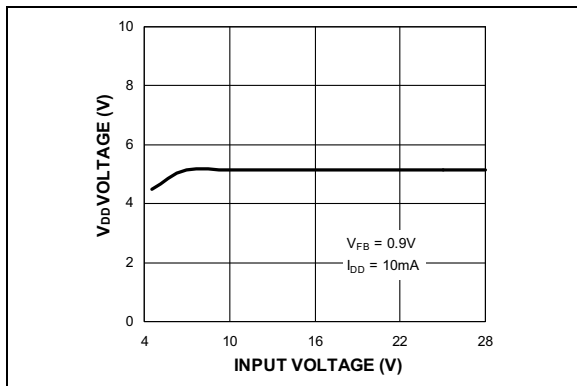
**FIGURE 2-4:** Feedback Voltage vs. Input Voltage.



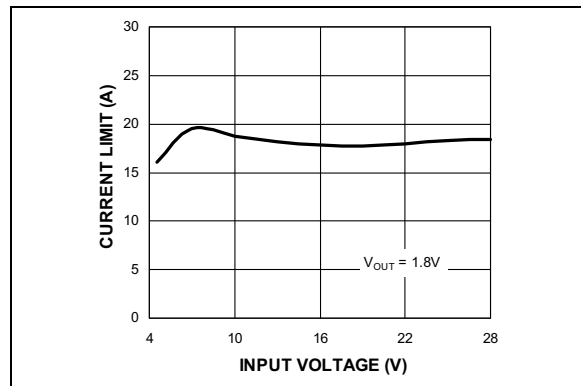
**FIGURE 2-2:**  $V_{IN}$  Shutdown Current vs. Input Voltage.



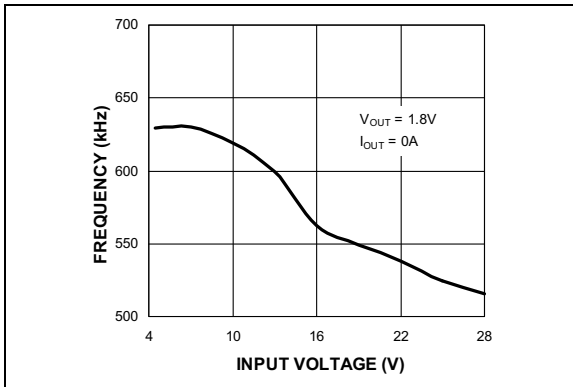
**FIGURE 2-5:** Total Regulation vs. Input Voltage.



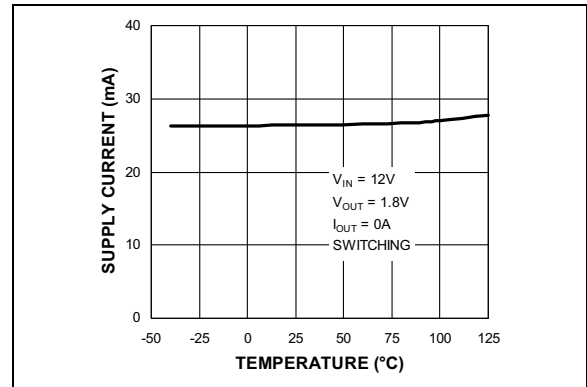
**FIGURE 2-3:**  $V_{DD}$  Output Voltage vs. Input Voltage.



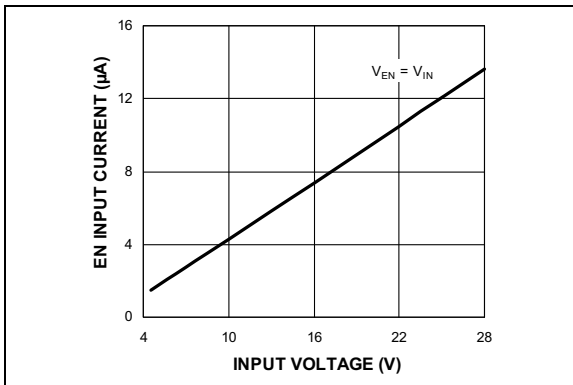
**FIGURE 2-6:** Current Limit vs. Input Voltage.



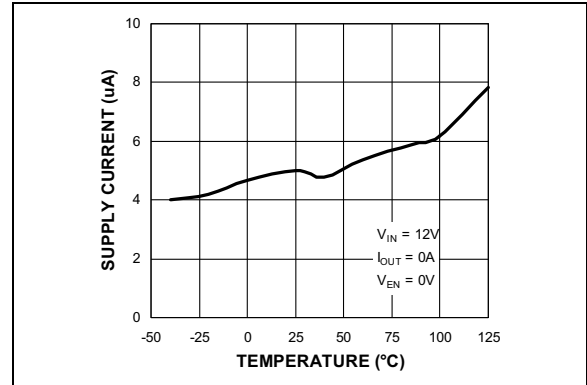
**FIGURE 2-7:** Switching Frequency vs. Input Voltage.



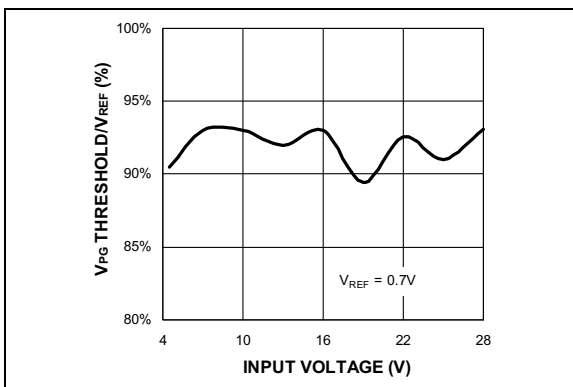
**FIGURE 2-10:**  $V_{IN}$  Operating Supply Current vs. Temperature.



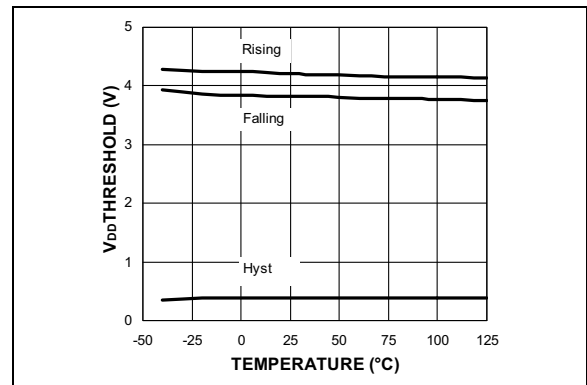
**FIGURE 2-8:** Enable Input Current vs. Input Voltage.



**FIGURE 2-11:**  $V_{IN}$  Shutdown Current vs. Temperature.

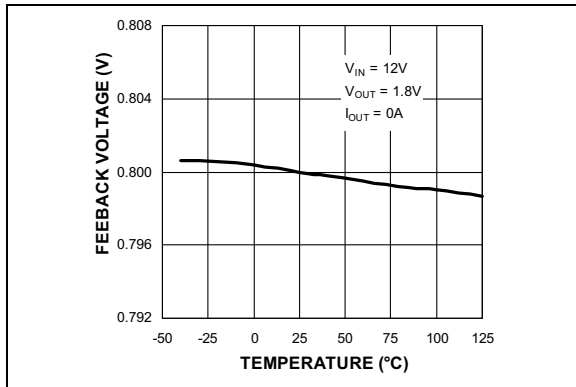


**FIGURE 2-9:** PG Threshold/ $V_{REF}$  Ratio vs. Input Voltage.

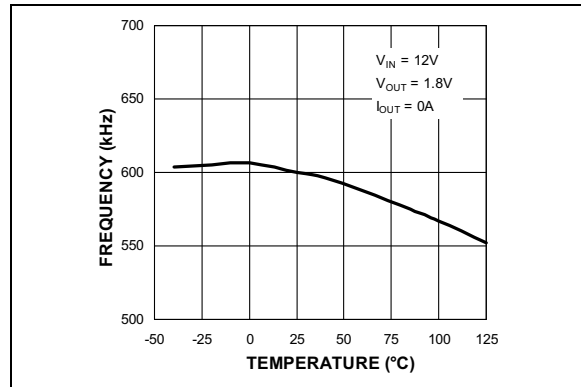


**FIGURE 2-12:**  $V_{DD}$  UVLO Threshold vs. Temperature.

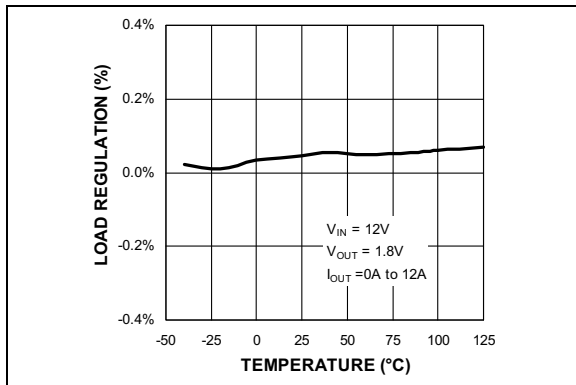
# MIC261201



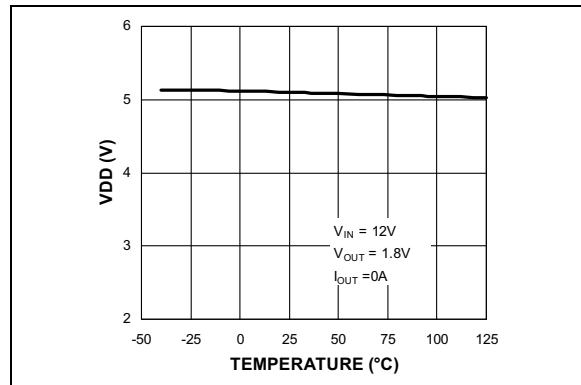
**FIGURE 2-13:** Feedback Voltage vs. Temperature.



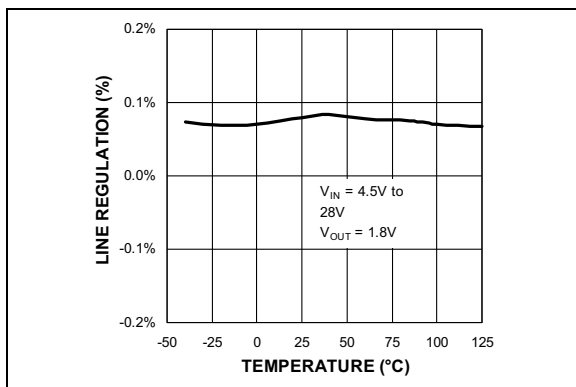
**FIGURE 2-16:** Switching Frequency vs. Temperature.



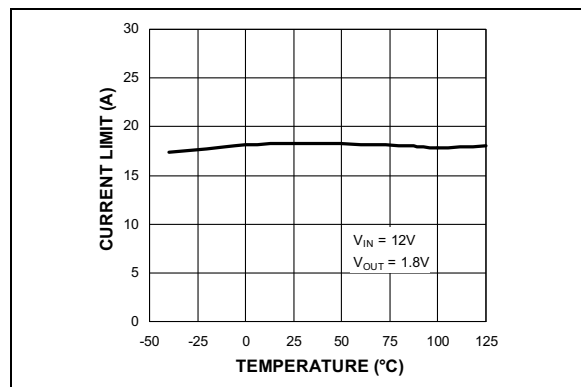
**FIGURE 2-14:** Load Regulation vs. Temperature.



**FIGURE 2-17:**  $V_{DD}$  vs. Temperature.

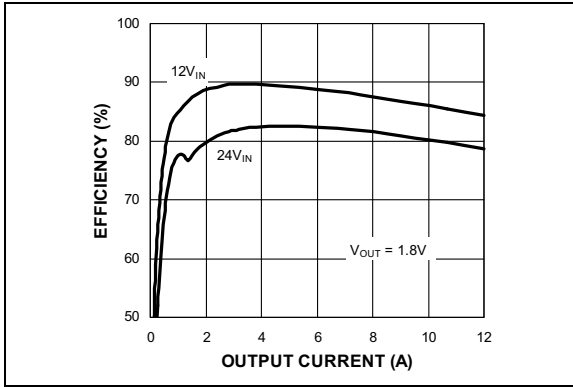


**FIGURE 2-15:** Line Regulation vs. Temperature.

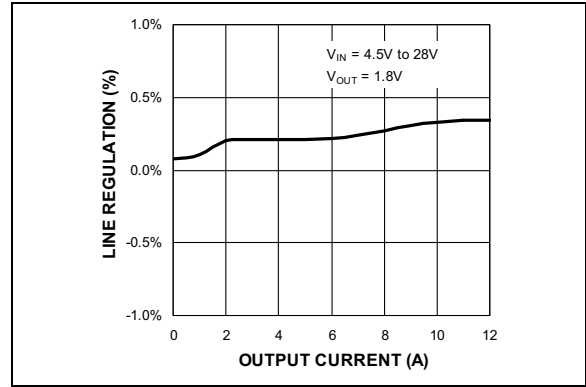


**FIGURE 2-18:** Current Limit vs. Temperature.

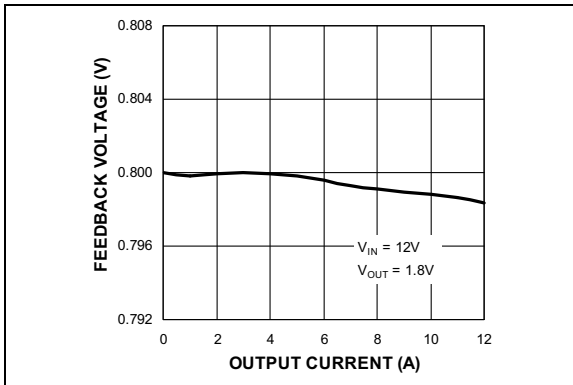




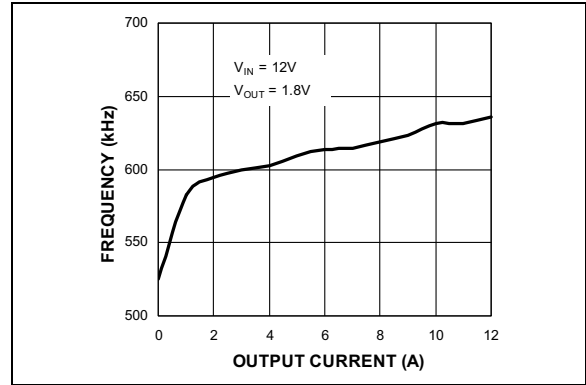
**FIGURE 2-19:** Efficiency vs. Output Current.



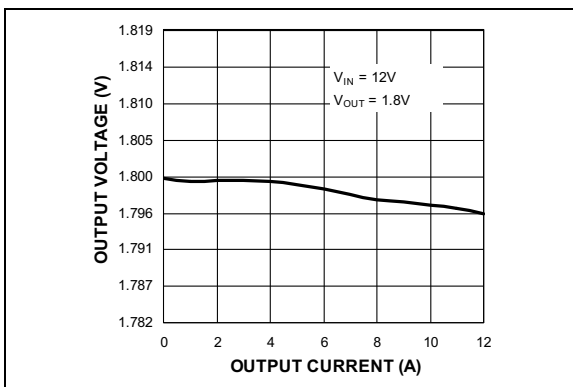
**FIGURE 2-22:** Line Regulation vs. Output Current.



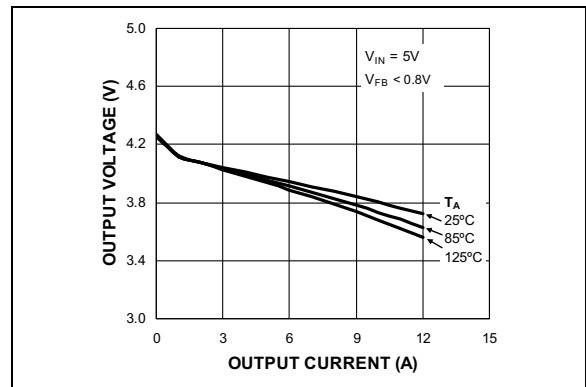
**FIGURE 2-20:** Feedback Voltage vs. Output Current.



**FIGURE 2-23:** Switching Frequency vs. Output Current.

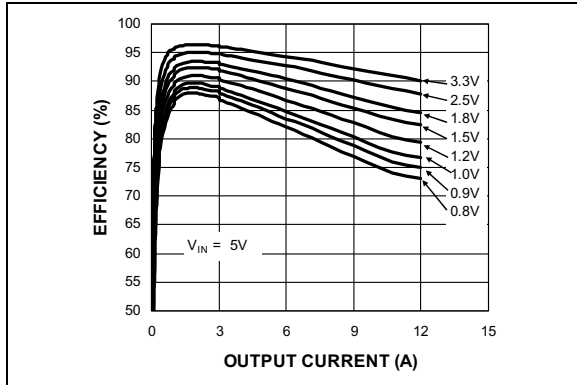


**FIGURE 2-21:** Output Voltage vs. Output Current.

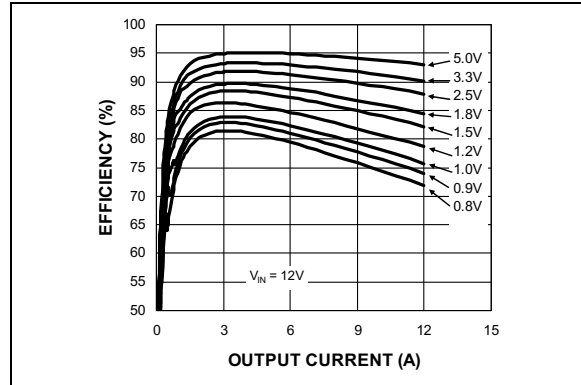


**FIGURE 2-24:** Output Voltage ( $V_{IN} = 5V$ ) vs. Output Current.

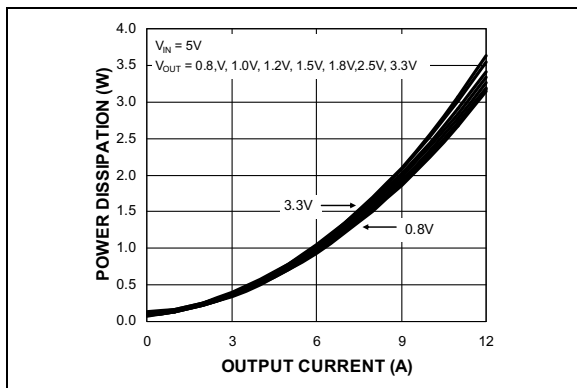
# MIC261201



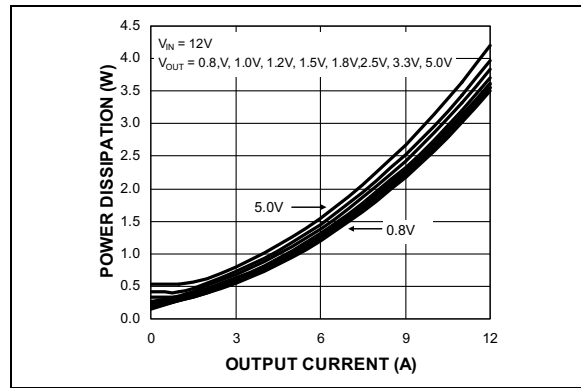
**FIGURE 2-25:** Efficiency ( $V_{IN} = 5V$ ) vs. Output Current.



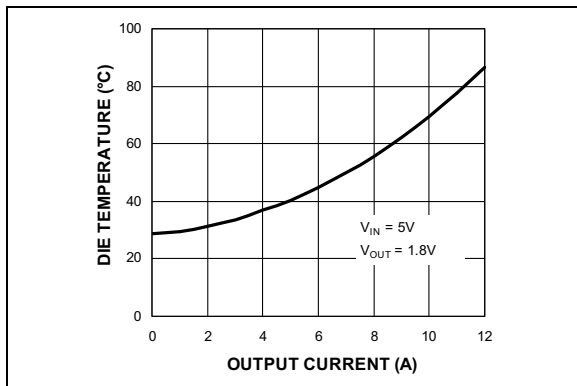
**FIGURE 2-28:** Efficiency ( $V_{IN} = 12V$ ) vs. Output Current.



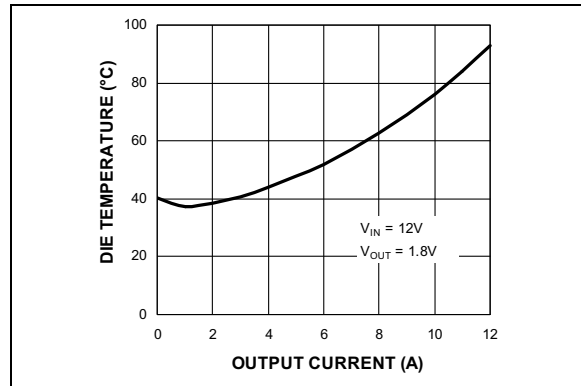
**FIGURE 2-26:** IC Power Dissipation ( $V_{IN} = 5V$ ) vs. Output Current.



**FIGURE 2-29:** IC Power Dissipation ( $V_{IN} = 12V$ ) vs. Output Current.

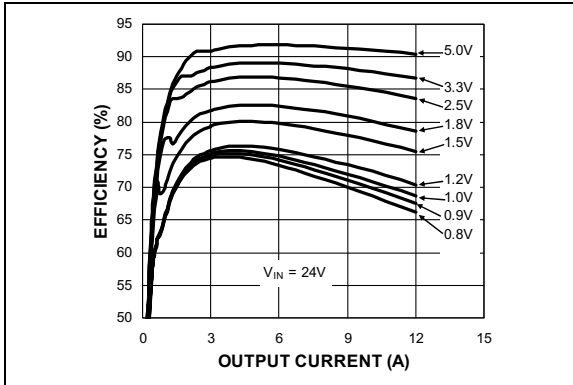


**FIGURE 2-27:** Die Temperature\* ( $V_{IN} = 5V$ ) vs. Output Current.

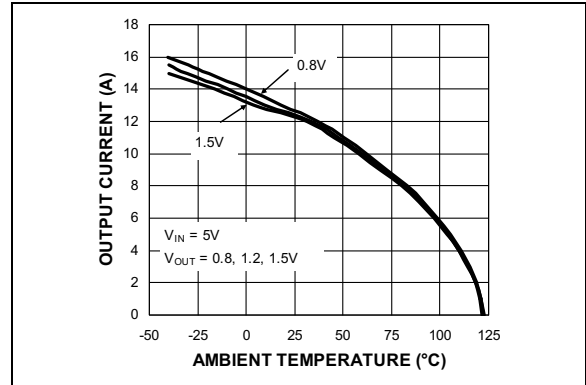


**FIGURE 2-30:** Die Temperature\* ( $V_{IN} = 12V$ ) vs. Output Current.

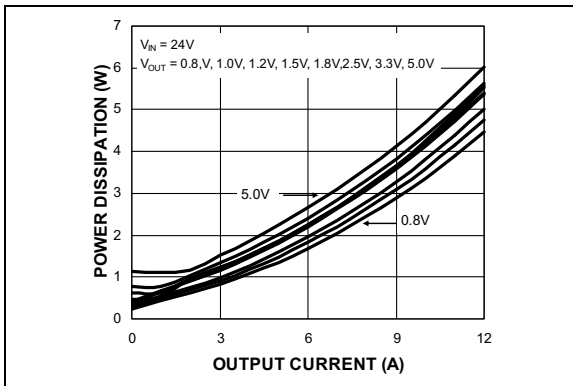
**Die Temperature\*:** The temperature measurement was taken at the hottest point on the MIC261201 case mounted on a 5 square inch 4 layer, 0.62", FR-4 PCB with 2 oz. finish copper weight per layer, see Thermal Measurement section. Actual results will depend upon the size of the PCB, ambient temperature and proximity to other heat emitting components.



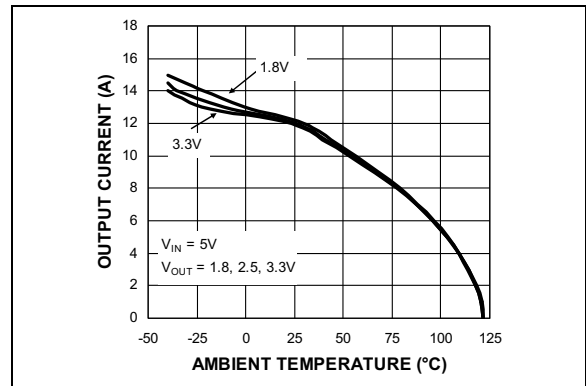
**FIGURE 2-31:** Efficiency ( $V_{IN} = 24V$ ) vs. Output Current.



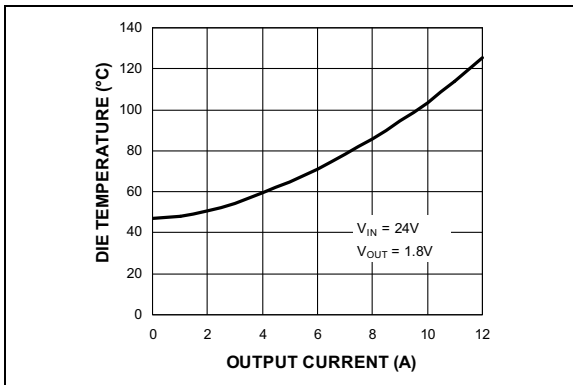
**FIGURE 2-34:** Thermal Derating\* vs. Ambient Temperature.



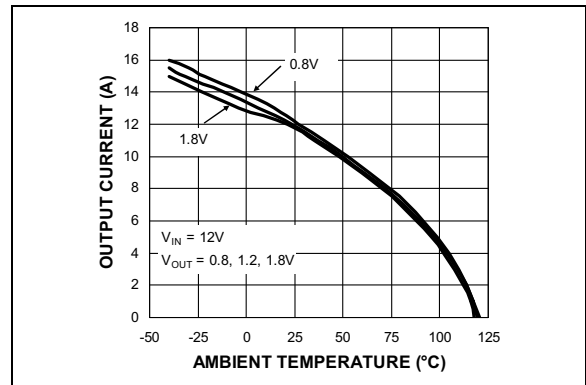
**FIGURE 2-32:** IC Power Dissipation ( $V_{IN} = 24V$ ) vs. Output Current.



**FIGURE 2-35:** Thermal Derating\* vs. Ambient Temperature.

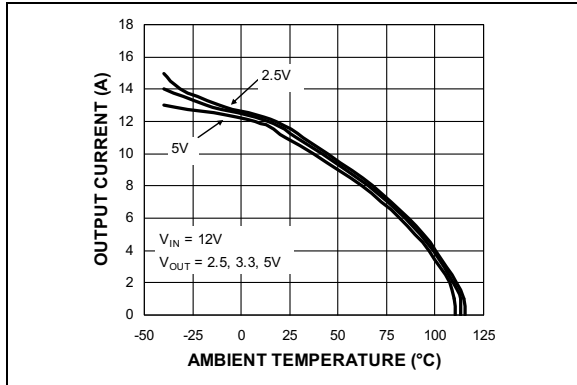


**FIGURE 2-33:** Die Temperature\* ( $V_{IN} = 24V$ ) vs. Output Current.

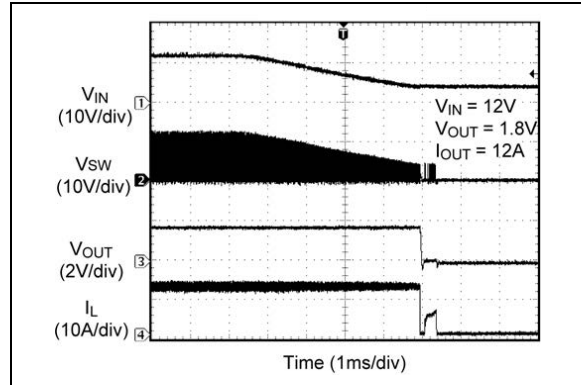


**FIGURE 2-36:** Thermal Derating\* vs. Ambient Temperature.

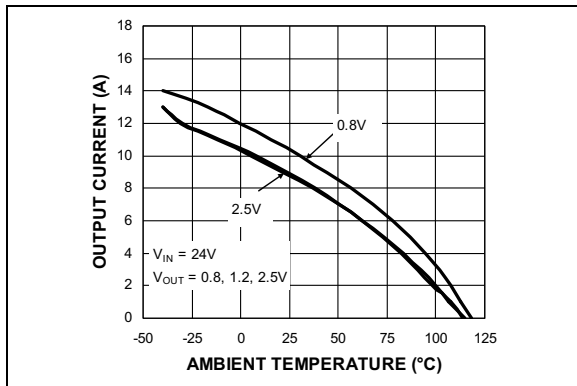
# MIC261201



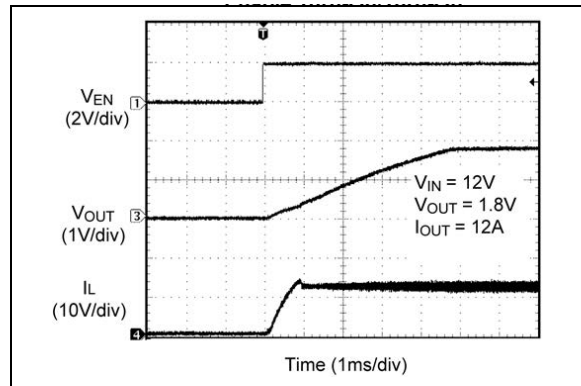
**FIGURE 2-37:** Thermal Derating\* vs. Ambient Temperature.



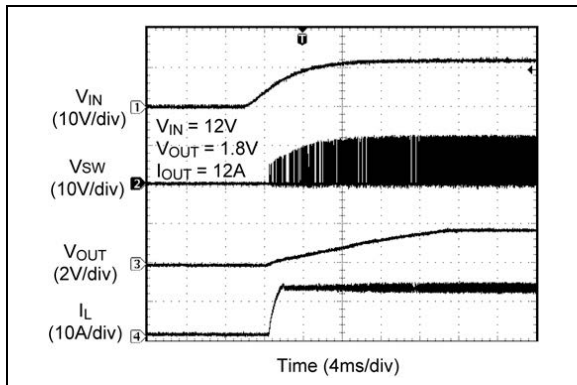
**FIGURE 2-40:**  $V_{IN}$  Soft Turn-Off.



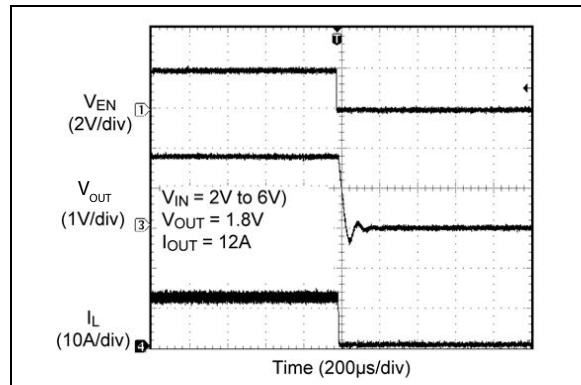
**FIGURE 2-38:** Thermal Derating\* vs. Ambient Temperature.



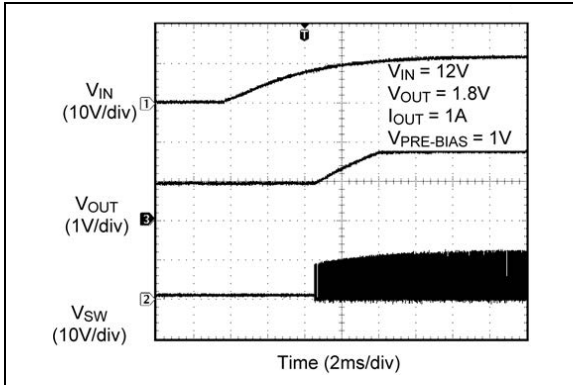
**FIGURE 2-41:** Enable Turn-On/Turn-Off.



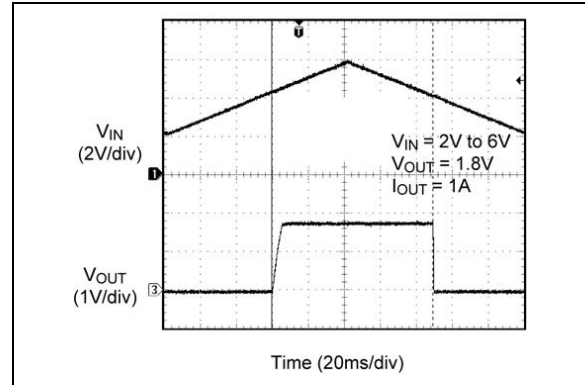
**FIGURE 2-39:**  $V_{IN}$  Soft Turn-On.



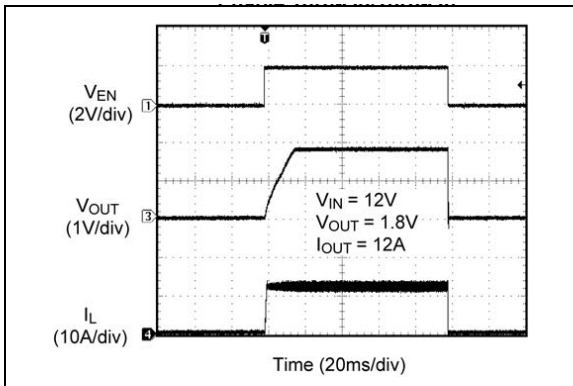
**FIGURE 2-42:** Enable Turn-Off Delay and Fall Time.



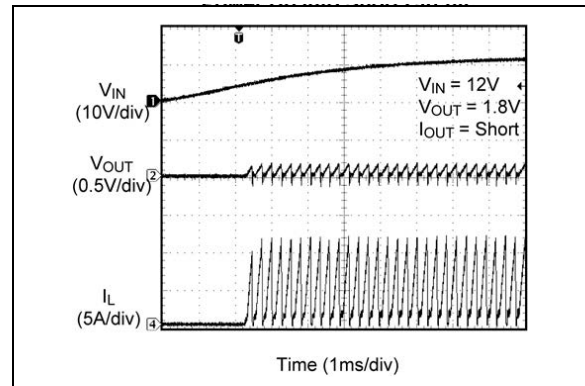
**FIGURE 2-43:**  $V_{IN}$  Start-Up with Pre-Biased Output.



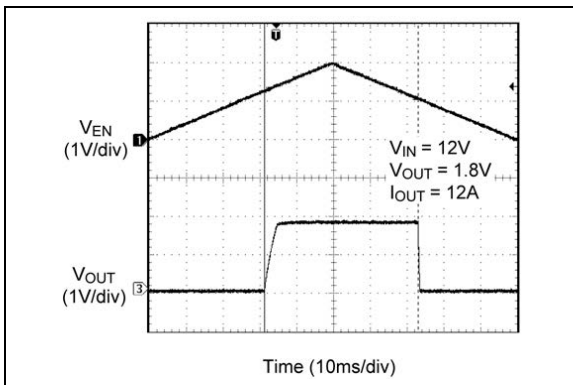
**FIGURE 2-46:**  $V_{IN}$  UVLO Thresholds.



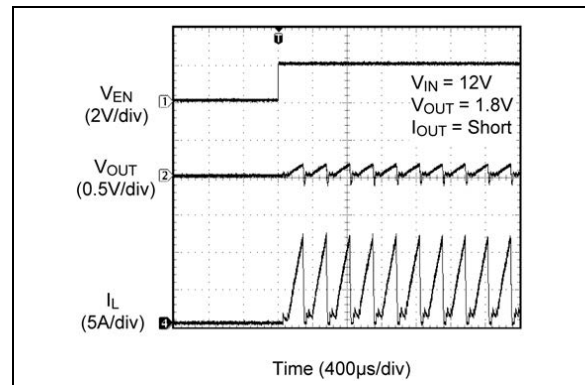
**FIGURE 2-44:** Enable Turn-On/Turn-Off.



**FIGURE 2-47:** Power Up into Short Circuit.

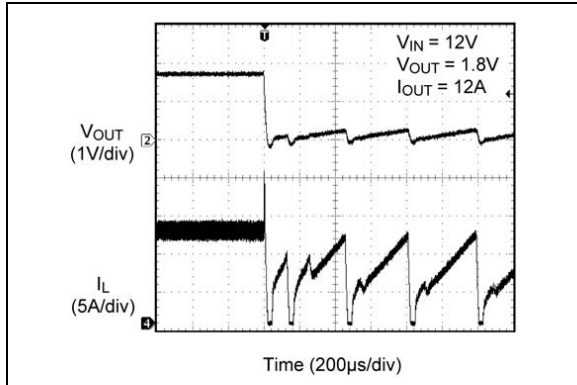


**FIGURE 2-45:** Enable Thresholds.

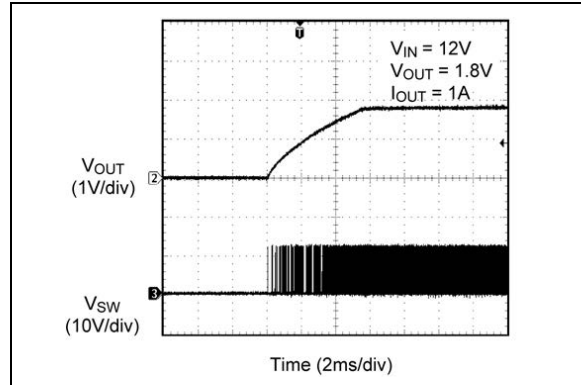


**FIGURE 2-48:** Enabled into Short.

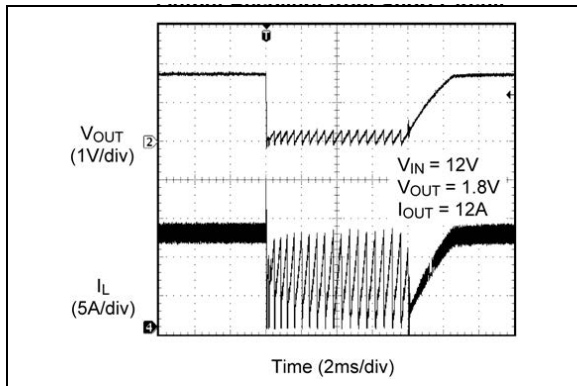
# MIC261201



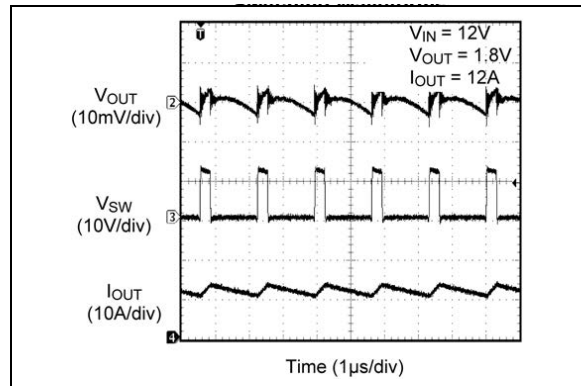
**FIGURE 2-49:** Short Circuit.



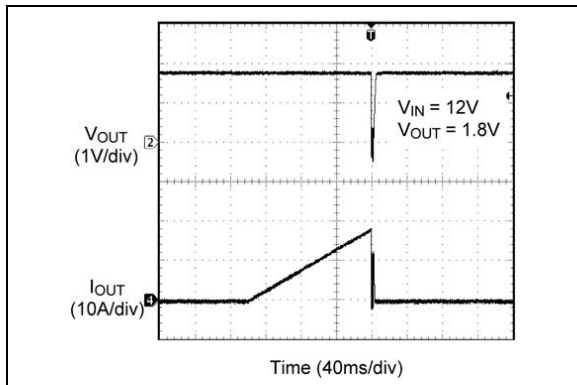
**FIGURE 2-52:** Output Recovery from Thermal Shutdown.



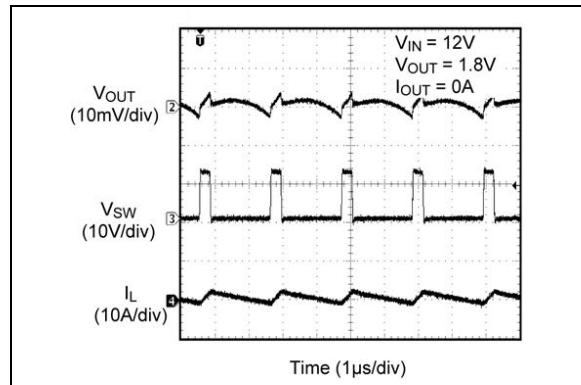
**FIGURE 2-50:** Output Recovery from Short Circuit.



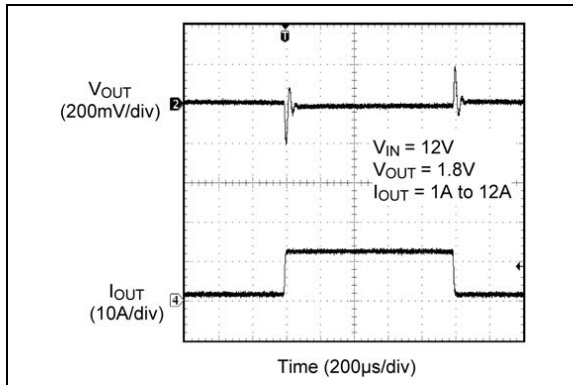
**FIGURE 2-53:** Switching Waveforms.



**FIGURE 2-51:** Peak Current Limit Threshold.



**FIGURE 2-54:** Switching Waveforms;  $I_{OUT} = 0A$ .



**FIGURE 2-55:** *Transient Response.*

# MIC261201

## 3.0 PIN DESCRIPTIONS

The descriptions of the pins are listed in [Table 3-1](#).

**TABLE 3-1: PIN FUNCTION TABLE**

Pin Number	Pin Name	Description
1	PVDD	5V Internal Linear Regulator (Output): PVDD supply is the power MOSFET gate drive supply voltage and created by internal LDO from $V_{IN}$ . When $V_{IN} < +5.5V$ , PVDD should be tied to the PVIN pins. A 2.2 $\mu F$ ceramic capacitor from the PVDD pin to PGND (Pin 2) must be place next to the IC.
3	NC	No connect.
4, 9, 10, 11, 12	SW	Switch Node (Output): Internal connection for the high-side MOSFET source and low-side MOSFET drain. Due to the high-speed switching on this pin, the SW pin should be routed away from sensitive nodes.
2, 5, 6, 7, 8, 21	PGND	Power Ground. PGND is the ground path for the MIC26903 buck converter power stage. The PGND pins connect to the low-side N-Channel internal MOSFET gate drive supply ground, the sources of the MOSFETs, the negative terminals of input capacitors, and the negative terminals of output capacitors. The loop for the power ground should be as small as possible and separate from the Signal Ground (SGND) loop.
13, 14, 15, 16, 17, 18, 19	PVIN	High-Side N-internal MOSFET Drain Connection (Input): The $PV_{IN}$ operating voltage range is from 4.5V to 28V. Input capacitors between the PVIN pins and the power ground (PGND) are required and keep the connection short.
20	BST	Boost (Output): Bootstrapped voltage to the high-side N-channel MOSFET driver. A Schottky diode is connected between the PVDD pin and the BST pin. A boost capacitor of 0.1 $\mu F$ is connected between the BST pin and the SW pin. Adding a small resistor at the BST pin can slow down the turn-on time of high-side N-Channel MOSFETs.
22	CS	Current Sense (Input): The CS pin senses current by monitoring the voltage across the low-side MOSFET during the OFF-time. The current sensing is necessary for short circuit protection. In order to sense the current accurately, connect the low-side MOSFET drain to SW using a Kelvin connection. The CS pin is also the high-side MOSFET's output driver return.
23	SGND	Signal ground. SGND must be connected directly to the ground planes. Do not route the SGND pin to the PGND Pad on the top layer, see PCB layout guidelines for details.
24	FB	Feedback (Input): Input to the transconductance amplifier of the control loop. The FB pin is regulated to 0.8V. A resistor divider connecting the feedback to the output is used to adjust the desired output voltage.
25	PG	Power Good (Output): Open Drain Output. The PG pin is externally tied with a resistor to VDD. A high output is asserted when $V_{OUT} > 92\%$ of nominal.
26	EN	Enable (input): A logic level control of the output. The EN pin is CMOS-compatible. Logic high = enable, logic low = shutdown. In the off state, supply current of the device is greatly reduced (typically 5 $\mu A$ ). The EN pin should not be left open.
27	VIN	Power Supply Voltage (Input): Requires bypass capacitor to SGND.
28	VDD	5V Internal Linear Regulator (Output): VDD supply is the power MOSFET gate drive supply voltage and the supply bus for the IC. VDD is created by internal LDO from $V_{IN}$ . When $V_{IN} < +5.5V$ , VDD should be tied to the PVIN pins. A 1.0 $\mu F$ ceramic capacitor from the VDD pin to PGND pins must be place next to the IC.



## 4.0 FUNCTIONAL DESCRIPTION

The MIC261201 is an adaptive ON-time synchronous step-down DC/DC regulator with an internal 5V linear regulator and a Power Good (PG) output. It is designed to operate over a wide input voltage range from 4.5V to 28V and provides a regulated output voltage at up to 7A of output current. An adaptive ON-time control scheme is employed to obtain a constant switching frequency and to simplify the control compensation. Overcurrent protection is implemented without the use of an external sense resistor. The device includes an internal soft-start function which reduces the power supply input surge current at start-up by controlling the output voltage rise time.

### 4.1 Theory of Operation

The MIC261201 operates in a continuous mode as shown in the [Functional Block Diagram](#).

### 4.2 Continuous Mode

In continuous mode, the output voltage is sensed by the MIC261201 feedback (FB) pin via the voltage divider R1 and R2, and compared to a 0.8V reference voltage  $V_{REF}$  at the error comparator through a low gain transconductance ( $g_m$ ) amplifier. If the feedback voltage decreases and the output of the  $g_m$  amplifier is below 0.8V, then the error comparator will trigger the control logic and generate an ON-time period. The ON-time period length is predetermined by the “FIXED  $t_{ON}$  ESTIMATION” circuitry:

#### EQUATION 4-1:

$$t_{ON(ESTIMATED)} = \frac{V_{OUT}}{V_{IN} \times 600kHz}$$

Where:

$V_{OUT}$  = Output voltage.

$V_{IN}$  = The power stage input voltage.

At the end of the ON-time period, the internal high-side driver turns off the high-side MOSFET and the low-side driver turns on the low-side MOSFET. The OFF-time period length depends upon the feedback voltage in most cases. When the feedback voltage decreases and the output of the  $g_m$  amplifier is below 0.8V, the ON-time period is triggered and the OFF-time period ends. If the OFF-time period determined by the feedback voltage is less than the minimum OFF-time  $t_{OFF(MIN)}$ , which is about 300 ns, the MIC261201 control logic will apply the  $t_{OFF(MIN)}$  instead.  $t_{OFF(MIN)}$  is required to maintain enough energy in the boost capacitor ( $C_{BST}$ ) to drive the high-side MOSFET.

The maximum duty cycle is obtained from the 300 ns  $t_{OFF(MIN)}$ :

#### EQUATION 4-2:

$$D_{MAX} = \frac{t_S - t_{OFF(MIN)}}{t_S} = 1 - \frac{300ns}{t_S}$$

Where:

$$t_S = 1/600 \text{ kHz} = 1.66 \mu s$$

It is not recommended to use MIC261201 with an OFF-time close to  $t_{OFF(MIN)}$  during steady-state operation. Also, as  $V_{OUT}$  increases, the internal ripple injection will increase and reduce the line regulation performance. Therefore, the maximum output voltage of the MIC261201 should be limited to 5.5V and the maximum external ripple injection should be limited to 200 mV. Please refer to the “Setting Output Voltage” section for more details.

The actual ON-time and resulting switching frequency will vary with the part-to-part variation in the rise and fall times of the internal MOSFETs, the output load current, and variations in the  $V_{DD}$  voltage. Also, the minimum  $t_{ON}$  results in a lower switching frequency in high  $V_{IN}$  to  $V_{OUT}$  applications, such as 24V to 1.0V. The minimum  $t_{ON}$  measured on the MIC261201 evaluation board is about 100 ns. During load transients, the switching frequency is changed due to the varying OFF-time.

To illustrate the control loop operation, we will analyze both the steady-state and load transient scenarios.

Figure 4-1 shows the MIC261201 control loop timing during steady-state operation. During steady-state, the  $g_m$  amplifier senses the feedback voltage ripple, which is proportional to the output voltage ripple and the inductor current ripple, to trigger the ON-time period. The ON-time is predetermined by the  $t_{ON}$  estimator. The termination of the OFF-time is controlled by the feedback voltage. At the valley of the feedback voltage ripple, which occurs when  $V_{FB}$  falls below  $V_{REF}$ , the OFF period ends and the next ON-time period is triggered through the control logic circuitry.

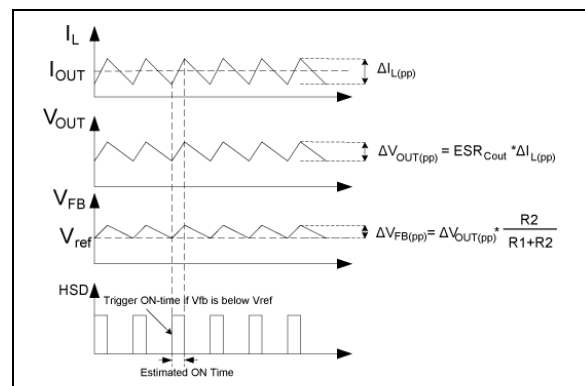
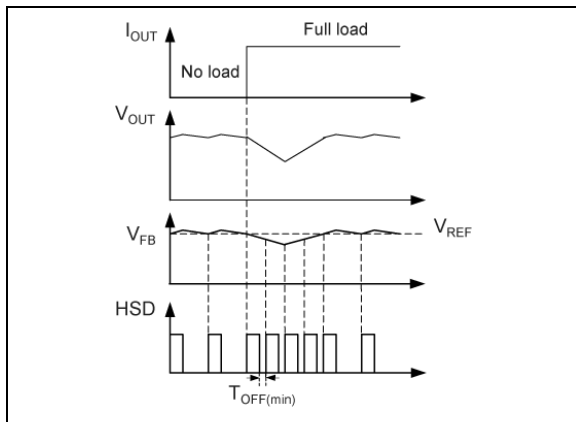


FIGURE 4-1: Control Loop Timing.

# MIC261201

Figure 4-2 shows the operation of the MIC261201 during a load transient. The output voltage drops due to the sudden load increase, which causes the  $V_{FB}$  to be less than  $V_{REF}$ . This will cause the error comparator to trigger an ON-time period. At the end of the ON-time period, a minimum OFF-time  $t_{OFF(MIN)}$  is generated to charge  $C_{BST}$  because the feedback voltage is still below  $V_{REF}$ . Then, the next ON-time period is triggered due to the low feedback voltage. Therefore, the switching frequency changes during the load transient, but returns to the nominal fixed frequency once the output has stabilized at the new load current level. With the varying duty cycle and switching frequency, the output recovery time is fast and the output voltage deviation is small in MIC261201 converter.



**FIGURE 4-2:** Load Transient Response.

Unlike true current-mode control, the MIC261201 uses the output voltage ripple to trigger an ON-time period. The output voltage ripple is proportional to the inductor current ripple if the ESR of the output capacitor is large enough. The MIC261201 control loop has the advantage of eliminating the need for slope compensation.

In order to meet the stability requirements, the MIC261201 feedback voltage ripple should be in phase with the inductor current ripple and large enough to be sensed by the  $g_m$  amplifier and the error comparator. The recommended feedback voltage ripple is 20 mV~100 mV. If a low-ESR output capacitor is selected, then the feedback voltage ripple may be too small to be sensed by the  $g_m$  amplifier and the error comparator. Also, the output voltage ripple and the feedback voltage ripple are not necessarily in phase with the inductor current ripple if the ESR of the output capacitor is very low. In these cases, ripple injection is required to ensure proper operation. Please refer to the [Ripple Injection](#) section for more details about the ripple injection technique.

## 4.3 $V_{DD}$ Regulator

The MIC261201 provides a 5V regulated output for input voltage  $V_{IN}$  ranging from 5.5V to 28V. When  $V_{IN} < 5.5V$ ,  $V_{DD}$  should be tied to the PVIN pins to bypass the internal linear regulator.

## 4.4 Soft-Start

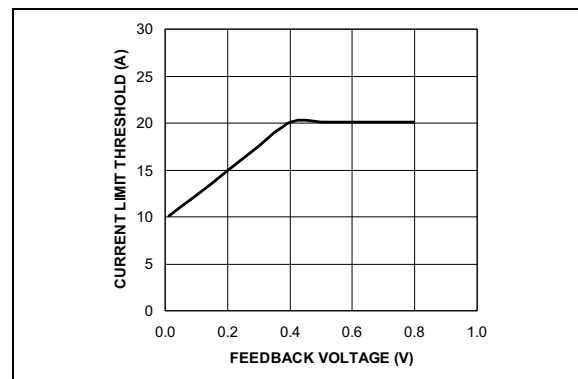
Soft-start reduces the power supply input surge current at startup by controlling the output voltage rise time. The input surge appears while the output capacitor is charged up. A slower output rise time will draw a lower input surge current.

The MIC261201 implements an internal digital soft-start by making the 0.8V reference voltage  $V_{REF}$  ramp from 0% to 100% in about 5 ms with 9.7 mV steps. Therefore, the output voltage is controlled to increase slowly by a stair-case  $V_{FB}$  ramp. Once the soft-start cycle ends, the related circuitry is disabled to reduce current consumption.  $V_{DD}$  must be powered up at the same time or after  $V_{IN}$  to make the soft-start function correctly.

## 4.5 Current Limit

The MIC261201 uses the  $R_{DS(ON)}$  of the internal low-side power MOSFET to sense overcurrent conditions. This method will avoid adding cost, board space and power losses taken by a discrete current sense resistor. The low-side MOSFET is used because it displays much lower parasitic oscillations during switching than the high-side MOSFET.

In each switching cycle of the MIC261201 converter, the inductor current is sensed by monitoring the low-side MOSFET in the OFF period. If the peak inductor current is greater than 26A, then the MIC261201 turns off the high-side MOSFET and a soft-start sequence is triggered. This mode of operation is called “hiccup mode” and its purpose is to protect the downstream load in case of a hard short. The load current-limit threshold has a fold back characteristic related to the feedback voltage as shown in [Figure 4-3](#).



**FIGURE 4-3:** Current-Limit Foldback Characteristic.

## 4.6 Power Good (PG)

The Power Good (PG) pin is an open-drain output that indicates logic high when the output is nominally 92% of its steady state voltage. A pull-up resistor of more than 10 k $\Omega$  should be connected from PG to VDD.

## 4.7 MOSFET Gate Drive

The [Functional Block Diagram](#) shows a bootstrap circuit, consisting of D1 (a Schottky diode is recommended) and C<sub>BST</sub>. This circuit supplies energy to the high-side drive circuit. Capacitor C<sub>BST</sub> is charged, while the low-side MOSFET is on, and the voltage on the SW pin is approximately 0V. When the high-side MOSFET driver is turned on, energy from C<sub>BST</sub> is used to turn the MOSFET on. As the high-side MOSFET turns on, the voltage on the SW pin increases to approximately V<sub>IN</sub>. Diode D1 is reverse-biased and C<sub>BST</sub> floats high while continuing to keep the high-side MOSFET on. The bias current of the high-side driver is less than 10 mA, so a 0.1  $\mu$ F to 1  $\mu$ F is sufficient to hold the gate voltage with minimal droop for the power stroke (high-side switching) cycle, i.e.  $\Delta$ BST = 10 mA  $\times$  1.67  $\mu$ s/0.1  $\mu$ F = 167 mV. When the low-side MOSFET is turned back on, C<sub>BST</sub> is recharged through D1.

A small resistor R<sub>G</sub>, which is in series with C<sub>BST</sub>, can be used to slow down the turn-on time of the high-side N-channel MOSFET.

The drive voltage is derived from the V<sub>DD</sub> supply voltage. The nominal low-side gate drive voltage is V<sub>DD</sub> and the nominal high-side gate drive voltage is approximately V<sub>DD</sub> - V<sub>DIODE</sub>, where V<sub>DIODE</sub> is the voltage drop across D1. An approximate 30 ns delay between the high-side and low-side driver transitions is used to prevent current from simultaneously flowing unimpeded through both MOSFETs.

# MIC261201

## 5.0 APPLICATIONS INFORMATION

### 5.1 Inductor Selection

Values for inductance, peak, and RMS currents are required to select the output inductor. The input and output voltages and the inductance value determine the peak-to-peak inductor ripple current. Generally, higher inductance values are used with higher input voltages. Larger peak-to-peak ripple currents will increase the power dissipation in the inductor and MOSFETs. Larger output ripple currents will also require more output capacitance to smooth out the larger ripple current. Smaller peak-to-peak ripple currents require a larger inductance value and therefore a larger and more expensive inductor. A good compromise between size, loss and cost is to set the inductor ripple current to be equal to 20% of the maximum output current. The inductance value is calculated by [Equation 5-1](#):

#### EQUATION 5-1:

$$L = \frac{V_{OUT} \times (V_{IN(MAX)} - V_{OUT})}{V_{IN(MAX)} \times f_{SW} \times 20\% \times I_{OUT(MAX)}}$$

Where:

$f_{SW}$  = Switching frequency of 600 kHz

20% = Ratio of AC ripple to DC output current

$V_{IN(MAX)}$  = Max. power stage input voltage

The peak-to-peak inductor current ripple is:

#### EQUATION 5-2:

$$\Delta I_{L(PP)} = \frac{V_{OUT} \times (V_{IN(MAX)} - V_{OUT})}{V_{IN(MAX)} \times f_{SW} \times L}$$

The peak inductor current is equal to the average output current plus one half of the peak-to-peak inductor current ripple.

#### EQUATION 5-3:

$$I_{L(PK)} = I_{OUT(MAX)} + 0.5 \times \Delta I_{L(PP)}$$

The RMS inductor current is used to calculate the  $I^2R$  losses in the inductor.

#### EQUATION 5-4:

$$I_{L(RMS)} = \sqrt{I_{OUT(MAX)}^2 + \frac{\Delta I_{L(PP)}^2}{12}}$$

Maximizing efficiency requires the proper selection of core material and minimizing the winding resistance. The high frequency operation of the MIC261201 requires the use of ferrite materials for all but the most cost sensitive applications. Lower cost iron powder cores may be used but the increase in core loss will reduce the efficiency of the power supply. This is especially noticeable at low output power. The winding resistance decreases efficiency at the higher output current levels. The winding resistance must be minimized although this usually comes at the expense of a larger inductor. The power dissipated in the inductor is equal to the sum of the core and copper losses. At higher output loads, the core losses are usually insignificant and can be ignored. At lower output currents, the core losses can be a significant contributor. Core loss information is usually available from the magnetic vendor. Copper loss in the inductor is calculated by [Equation 5-5](#):

#### EQUATION 5-5:

$$P_{INDUCTOR(CU)} = I_{L(RMS)}^2 \times R_{WINDING}$$

The resistance of the copper wire,  $R_{WINDING}$ , increases with the temperature. The value of the winding resistance used should be at the operating temperature.

#### EQUATION 5-6:

$$P_{WINDING(HT)} = R_{WINDING(20^\circ C)} \times (1 + 0.0042 \times [T_H - T_{20^\circ C}])$$

Where:

$T_H$  = Temperature of wire under full load

$T_{20^\circ C}$  = Ambient temperature

$R_{WINDING(20^\circ C)}$  = Room temperature winding resistance (usually specified by the manufacturer)

## 5.2 Output Capacitor Selection

The type of the output capacitor is usually determined by its equivalent series resistance (ESR). Voltage and RMS current capability are two other important factors for selecting the output capacitor. Recommended capacitor types are ceramic, low-ESR aluminum electrolytic, OS-CON and POSCAP. The output capacitor's ESR is usually the main cause of the output ripple. The output capacitor ESR also affects the control loop from a stability point of view.

The maximum value of ESR is calculated:

### EQUATION 5-7:

$$ESR_{COUT} \leq \frac{\Delta V_{OUT(PP)}}{\Delta I_{L(PP)}}$$

Where:

$\Delta V_{OUT(PP)}$  = Peak-to-peak output voltage ripple

$\Delta I_{L(PP)}$  = Peak-to-peak inductor current ripple

The total output ripple is a combination of the ESR and output capacitance. The total ripple is calculated in [Equation 5-8](#):

### EQUATION 5-8:

$$\Delta V_{OUT(PP)} = \sqrt{\left(\frac{\Delta I_{L(PP)}}{C_{OUT} \times f_{SW} \times 8}\right)^2 + (\Delta I_{L(PP)} \times ESR_{COUT})^2}$$

Where:

$C_{OUT}$  = Output capacitance value

$f_{SW}$  = Switching frequency

As described in the [Theory of Operation](#) section, the MIC261201 requires at least 20 mV peak-to-peak ripple at the FB pin to make the  $g_m$  amplifier and the error comparator behave properly. Also, the output voltage ripple should be in phase with the inductor current. Therefore, the output voltage ripple caused by the output capacitors value should be much smaller than the ripple caused by the output capacitor ESR. If low-ESR capacitors, such as ceramic capacitors, are selected as the output capacitors, a ripple injection method should be applied to provide the enough feedback voltage ripple. Please refer to the [Ripple Injection](#) section for more details.

The voltage rating of the capacitor should be twice the output voltage for a tantalum and 20% greater for aluminum electrolytic or OS-CON. The output capacitor RMS current is calculated in [Equation 5-9](#):

### EQUATION 5-9:

$$I_{COUT(RMS)} = \frac{\Delta I_{L(PP)}}{\sqrt{12}}$$

The power dissipated in the output capacitor is:

### EQUATION 5-10:

$$P_{DISS(COUT)} = I_{COUT(RMS)}^2 \times ESR_{COUT}$$

## 5.3 Input Capacitor Selection

The input capacitor for the power stage input  $V_{IN}$  should be selected for ripple current rating and voltage rating. Tantalum input capacitors may fail when subjected to high inrush currents, caused by turning the input supply on. A tantalum input capacitor's voltage rating should be at least two times the maximum input voltage to maximize reliability. Aluminum electrolytic, OS-CON, and multilayer polymer film capacitors can handle the higher inrush currents without voltage derating. The input voltage ripple will primarily depend on the input capacitor's ESR. The peak input current is equal to the peak inductor current, so:

### EQUATION 5-11:

$$\Delta V_{IN} = I_{L(PK)} \times ESR_{CIN}$$

The input capacitor must be rated for the input current ripple. The RMS value of input capacitor current is determined at the maximum output current. Assuming the peak-to-peak inductor current ripple is low:

### EQUATION 5-12:

$$I_{CIN(RMS)} \approx I_{OUT(MAX)} \times \sqrt{D \times (1 - D)}$$

The power dissipated in the input capacitor is:

### EQUATION 5-13:

$$P_{DISS(CIN)} = I_{CIN(RMS)}^2 \times ESR_{CIN}$$

# MIC261201

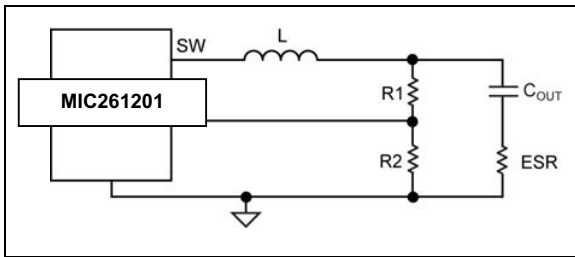
## 5.4 Ripple Injection

The  $V_{FB}$  ripple required for proper operation of the MIC261201  $g_m$  amplifier and error comparator is 20 mV to 100 mV. However, the output voltage ripple is generally designed as 1% to 2% of the output voltage. For a low output voltage, such as a 1V, the output voltage ripple is only 10 mV to 20 mV, and the feedback voltage ripple is less than 20 mV. If the feedback voltage ripple is so small that the  $g_m$  amplifier and error comparator can't sense it, then the MIC261201 will lose control and the output voltage is not regulated. In order to have some amount of  $V_{FB}$  ripple, a ripple injection method is applied for low output voltage ripple applications.

The applications are divided into three situations according to the amount of the feedback voltage ripple:

1. Enough ripple at the feedback voltage due to the large ESR of the output capacitors.

As shown in Figure 5-1, the converter is stable without any ripple injection.



**FIGURE 5-1:** Enough Ripple at FB.

The feedback voltage ripple is:

### EQUATION 5-14:

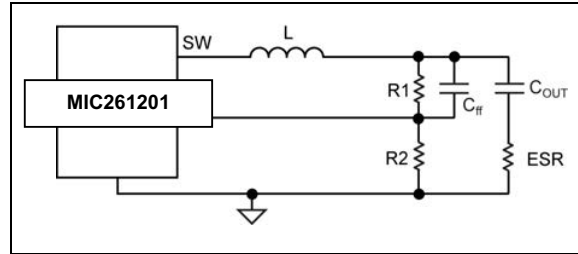
$$\Delta V_{FB(PP)} = \frac{R2}{R1 + R2} \times ESR_{COUT} \times \Delta I_{L(PP)}$$

Where:

$\Delta I_{L(PP)}$  = Peak-to-peak inductor current ripple

2. Inadequate ripple at the feedback voltage due to the small ESR of the output capacitors.

The output voltage ripple is fed into the FB pin through a feedforward capacitor  $C_{FF}$  in this situation, as shown in Figure 5-2. The typical  $C_{FF}$  value is between 1 nF and 100 nF.



**FIGURE 5-2:** Inadequate Ripple at FB.

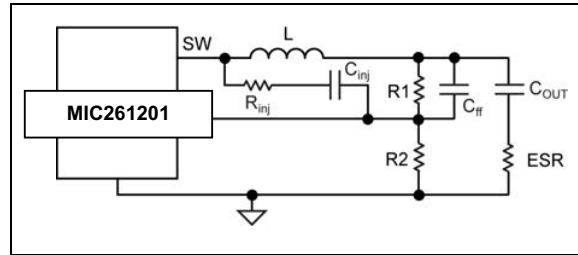
With the feedforward capacitor, the feedback voltage ripple is very close to the output voltage ripple:

### EQUATION 5-15:

$$\Delta V_{FB(PP)} \approx ESR \times \Delta I_{L(PP)}$$

3. Virtually no ripple at the FB pin voltage due to the very-low ESR of the output capacitors.

In this situation, the output voltage ripple is less than 20 mV. Therefore, additional ripple is injected into the FB pin from the switching node SW via a resistor  $R_{INJ}$  and a capacitor  $C_{INJ}$ , as shown in Figure 5-3.



**FIGURE 5-3:** Invisible Ripple at FB.

The injected ripple is:

### EQUATION 5-16:

$$\Delta V_{FB(PP)} = V_{IN} \times K_{DIV} \times D \times (1 - D) \times \frac{1}{f_{SW} \times \tau}$$

$$K_{DIV} = \frac{R1/R2}{R_{INJ} + R1/R2}$$

Where:

$V_{IN}$  = Power stage input voltage

$D$  = Duty cycle

$f_{SW}$  = Switching frequency

$\tau = (R1/R2/R_{INJ}) \times C_{FF}$

In [Equation 5-17](#) and [Equation 5-18](#) it is assumed that the time constant associated with  $C_{FF}$  must be much greater than the switching period:

### EQUATION 5-17:

$$\frac{1}{f_{SW} \times \tau} = \frac{1}{\tau} \ll 1$$

If the voltage divider resistors R1 and R2 are in the kΩ range, a  $C_{FF}$  of 1 nF to 100 nF can easily satisfy the large time constant requirements. Also, a 100 nF injection capacitor  $C_{INJ}$  is used in order to be considered as short for a wide range of the frequencies.

The process of sizing the ripple injection resistor and capacitors is:

**Step 1.** Select  $C_{FF}$  to feed all output ripples into the feedback pin and make sure the large time constant assumption is satisfied. Typical choice of  $C_{FF}$  is 1 nF to 100 nF if R1 and R2 are in the kΩ range.

**Step 2.** Select  $R_{INJ}$  according to the expected feedback voltage ripple using [Equation 5-19](#):

### EQUATION 5-18:

$$K_{DIV} = \frac{\Delta V_{FB(PP)}}{V_{IN}} \times \frac{f_{SW} \times \tau}{D \times (1-D)}$$

Then the value of  $R_{INJ}$  is obtained by:

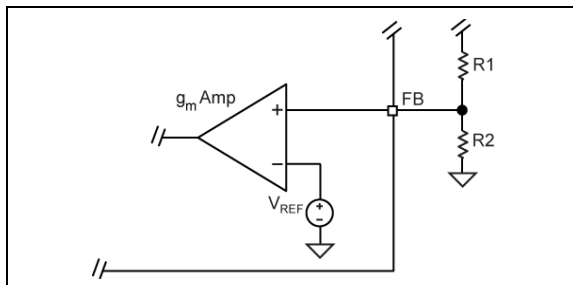
### EQUATION 5-19:

$$R_{INJ} = (R1//R2) \times \left( \frac{1}{K_{DIV}} - 1 \right)$$

**Step 3.** Select  $C_{INJ}$  as 100 nF, which could be considered as short for a wide range of the frequencies.

## 5.5 Setting Output Voltage

The MIC261201 requires two resistors to set the output voltage as shown in [Figure 5-4](#).



**FIGURE 5-4:** Voltage Divider Configuration.

The output voltage is determined by [Equation 5-20](#):

### EQUATION 5-20:

$$V_{OUT} = V_{FB} \times \left( 1 + \frac{R1}{R2} \right)$$

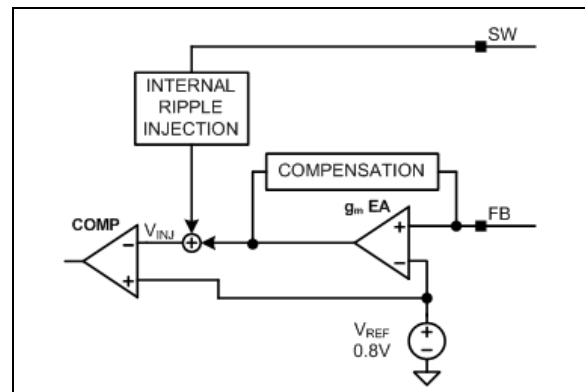
Where:  
 $V_{FB} = 0.8V$

A typical value of R1 can be between 3 kΩ and 10 kΩ. If R1 is too large, it may allow noise to be introduced into the voltage feedback loop. If R1 is too small, it will decrease the efficiency of the power supply, especially at light loads. Once R1 is selected, R2 can be calculated using:

### EQUATION 5-21:

$$R2 = \frac{V_{FB} \times R1}{V_{OUT} - V_{FB}}$$

In addition to the external ripple injection added at the FB pin, internal ripple injection is added at the inverting input of the comparator inside the MIC261201, as shown in [Figure 5-5](#). The inverting input voltage  $V_{INJ}$  is clamped to 1.2V. As  $V_{OUT}$  is increased, the swing of  $V_{INJ}$  will be clamped. The clamped  $V_{INJ}$  reduces the line regulation because it is reflected as a DC error on the FB terminal. Therefore, the maximum output voltage of the MIC261201 should be limited to 5.5V to avoid this problem.



**FIGURE 5-5:** Internal Ripple Injection.

## 5.6 Thermal Measurements

Measuring the IC's case temperature is recommended to insure it is within its operating limits. Although this might seem like a very elementary task, it is easy to get erroneous results. The most common mistake is to use the standard thermal couple that comes with a thermal meter. This thermal couple wire gauge is large, typically 22 gauge, and behaves like a heatsink, resulting in a lower case measurement.

# MIC261201

---

Two methods of temperature measurement are using a smaller thermal couple wire or an infrared thermometer. If a thermal couple wire is used, it must be constructed of 36 gauge wire or higher then (smaller wire size) to minimize the wire heat-sinking effect. In addition, the thermal couple tip must be covered in either thermal grease or thermal glue to make sure that the thermal couple junction is making good contact with the case of the IC. Omega brand thermal couple (5SC-TT-K-36-36) is adequate for most applications.

Wherever possible, an infrared thermometer is recommended. The measurement spot size of most infrared thermometers is too large for an accurate reading on a small form factor ICs. However, a IR thermometer from Optris has a 1 mm spot size, which makes it a good choice for measuring the hottest point on the case. An optional stand makes it easy to hold the beam on the IC for long periods of time.



## 6.0 PCB LAYOUT GUIDELINES

To minimize EMI and output noise, follow these layout recommendations.

PCB Layout is critical to achieve reliable, stable and efficient performance. A ground plane is required to control EMI and minimize the inductance in power, signal and return paths.

The following guidelines should be followed to insure proper operation of the MIC261201 regulator.

### 6.1 IC

- A 2.2  $\mu\text{F}$  ceramic capacitor, which is connected to the PVDD pin, must be located right at the IC. The PVDD pin is very noise sensitive and placement of the capacitor is very critical. Use wide traces to connect to the PVDD and PGND pins.
- A 1.0  $\mu\text{F}$  ceramic capacitor must be placed right between VDD and the signal ground SGND. The SGND must be connected directly to the ground planes. Do not route the SGND pin to the PGND Pad on the top layer.
- Place the IC close to the point-of-load (POL).
- Use fat traces to route the input and output power lines.
- Signal and power grounds should be kept separate and connected at only one location.

### 6.2 Input Capacitor

- Place the input capacitor next.
- Place the input capacitors on the same side of the board and as close to the IC as possible.
- Keep both the PVIN pin and PGND connections short.
- Place several vias to the ground plane close to the input capacitor ground terminal.
- Use either X7R or X5R dielectric input capacitors. Do not use Y5V or Z5U type capacitors.
- Do not replace the ceramic input capacitor with any other type of capacitor. Any type of capacitor can be placed in parallel with the input capacitor.
- If a Tantalum input capacitor is placed in parallel with the input capacitor, it must be recommended for switching regulator applications and the operating voltage must be derated by 50%.
- In "Hot-Plug" applications, a Tantalum or Electrolytic bypass capacitor must be used to limit the over-voltage spike seen on the input supply with power is suddenly applied.

### 6.3 Inductor

- Keep the inductor connection to the switch node (SW) short.
- Do not route any digital lines underneath or close to the inductor.
- Keep the switch node (SW) away from the feedback (FB) pin.
- The CS pin should be connected directly to the SW pin to accurately sense the voltage across the low-side MOSFET.
- To minimize noise, place a ground plane underneath the inductor.
- The inductor can be placed on the opposite side of the PCB with respect to the IC. It does not matter whether the IC or inductor is on the top or bottom as long as there is enough air flow to keep the power components within their temperature limits. The input and output capacitors must be placed on the same side of the board as the IC.

### 6.4 Output Capacitor

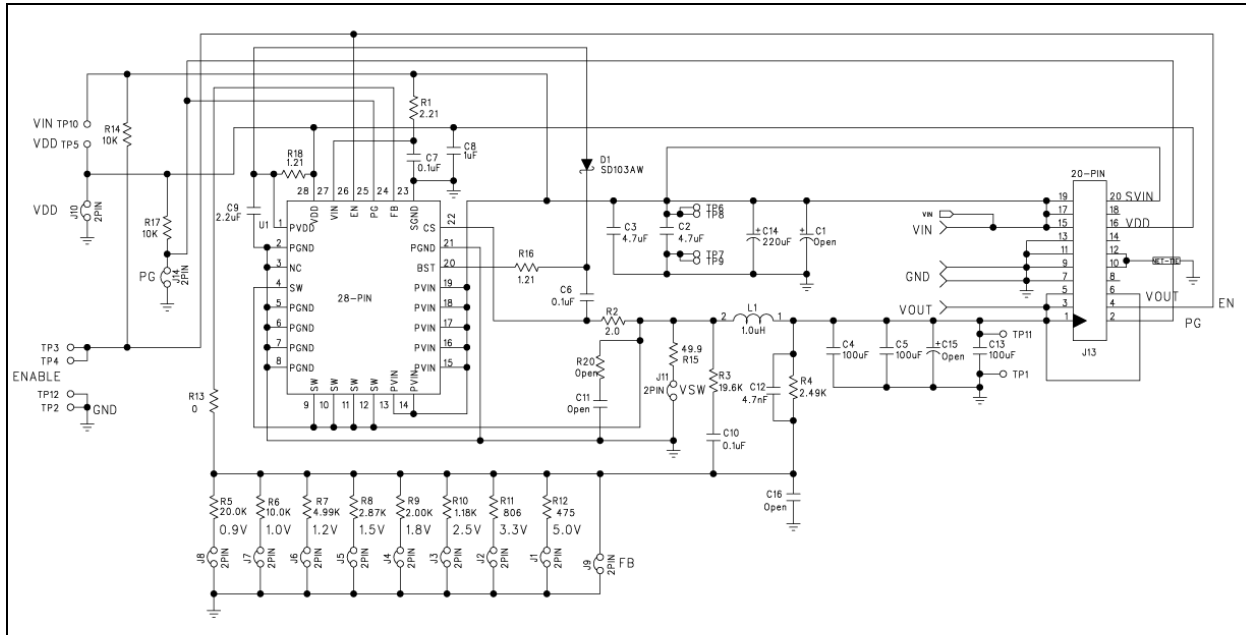
- Use a wide trace to connect the output capacitor ground terminal to the input capacitor ground terminal.
- Phase margin will change as the output capacitor value and ESR changes. Contact the factory if the output capacitor is different from what is shown in the BOM.
- The feedback trace should be separate from the power trace and connected as close as possible to the output capacitor. Sensing a long high current load trace can degrade the DC load regulation.

### 6.5 Optional RC Snubber

- Place the RC snubber on either side of the board and as close to the SW pin as possible.

# MIC261201

## 7.0 EVALUATION BOARD SCHEMATIC



**FIGURE 7-1:** Schematic of MIC261201 Evaluation Board (J11, R13, R15 are for Testing Purposes).

**TABLE 7-1: BILL OF MATERIALS**

Item	Part Number	Manufacturer	Description	Qty.
C1	Open	—	—	—
C2, C3	12105C475KAZ2A	AVX	4.7 µF Ceramic Capacitor, X7R, Size 1210, 50V	2
	GRM32ER71H475KA88L	Murata		
	C3225X7R1H475K	TDK		
C15	Open	—	—	—
C4, C5, C13	12106D107MAT2A	AVX	100 µF Ceramic Capacitor, X5R, Size 1210, 6.3V	3
	GRM32ER60J107ME20L	Murata		
	C3225X5R0J107M	TDK		
C6, C7, C10	06035C104KAT2A	AVX	0.1 µF Ceramic Capacitor, X7R, Size 0603, 50V	3
	GRM188R71H104KA93D	Murata		
	C1608X7R1H104K	TDK		
C8	0603ZC105KAT2A	AVX	1.0 µF Ceramic Capacitor, X7R, Size 0603, 10V	1
	GRM188R71A105KA61D	Murata		
	C1608X7R1A105K	TDK		
C9	0603ZD225KAT2A	AVX	2.2 µF Ceramic Capacitor, X7R, Size 0603, 10V	1
	GRM188R61A225KE34D	Murata		
	C1608X5R1A225K	TDK		
C12	06035C472KAZ2A	AVX	4.7 nF Ceramic Capacitor, X7R, Size 0603, 50V	1
	GRM188R71H472K	Murata		
	C1608X7R1H472K	TDK		
C14	B41851F7227M	EPCOS	220 µF Aluminum Capacitor, 35V	1
C11, C16	Open	—	—	—

**TABLE 7-1: BILL OF MATERIALS (CONTINUED)**

Item	Part Number	Manufacturer	Description	Qty.
D1	SD103AWS	MCC	40V, 350 mA, Schottky Diode, SOD323	1
	SD103AWS-7	Diodes, Inc.		
	SD103AWS	Vishay		
L1	HCF1305-1R0-R	Cooper Bussmann	1.0 $\mu$ H Inductor, 21A Saturation Current	1
R1	CRCW06032R21FKEA	Vishay Dale	2.21 $\Omega$ Resistor, Size 0603, 1%	1
R2	CRCW06032R00FKEA	Vishay Dale	2.00 $\Omega$ Resistor, Size 0603, 1%	1
R3	CRCW060319K6FKEA	Vishay Dale	19.6 k $\Omega$ Resistor, Size 0603, 1%	1
R4	CRCW06032K49FKEA	Vishay Dale	2.49 k $\Omega$ Resistor, Size 0603, 1%	1
R5	CRCW060320K0FKEA	Vishay Dale	20.0 k $\Omega$ Resistor, Size 0603, 1%	1
R6, R14, R17	CRCW060310K0FKEA	Vishay Dale	10.0 k $\Omega$ Resistor, Size 0603, 1%	3
R7	CRCW06034K99FKEA	Vishay Dale	4.99 k $\Omega$ Resistor, Size 0603, 1%	1
R8	CRCW06032K87FKEA	Vishay Dale	2.87 k $\Omega$ Resistor, Size 0603, 1%	1
R9	CRCW06032K006FKEA	Vishay Dale	2.00 k $\Omega$ Resistor, Size 0603, 1%	1
R10	CRCW06031K18FKEA	Vishay Dale	1.18 k $\Omega$ Resistor, Size 0603, 1%	1
R11	CRCW0603806RFKEA	Vishay Dale	806 $\Omega$ Resistor, Size 0603, 1%	1
R12	CRCW0603475RFKEA	Vishay Dale	475 $\Omega$ Resistor, Size 0603, 1%	1
R13	CRCW06030000FKEA	Vishay Dale	0 $\Omega$ Resistor, Size 0603, 5%	1
R15	CRCW060349R9FKEA	Vishay Dale	49.9 $\Omega$ Resistor, Size 0603, 1%	1
R16, R18	CRCW06031R21FKEA	Vishay Dale	1.21 $\Omega$ Resistor, Size 0603, 1%	2
R20	Open	—	—	—
U1	MIC261201YJL	Microchip	28V, 12A Hyper Speed Control? Synchronous DC/DC Buck Regulator	

# MIC261201

## 8.0 PCB EVALUATION BOARD LAYOUT

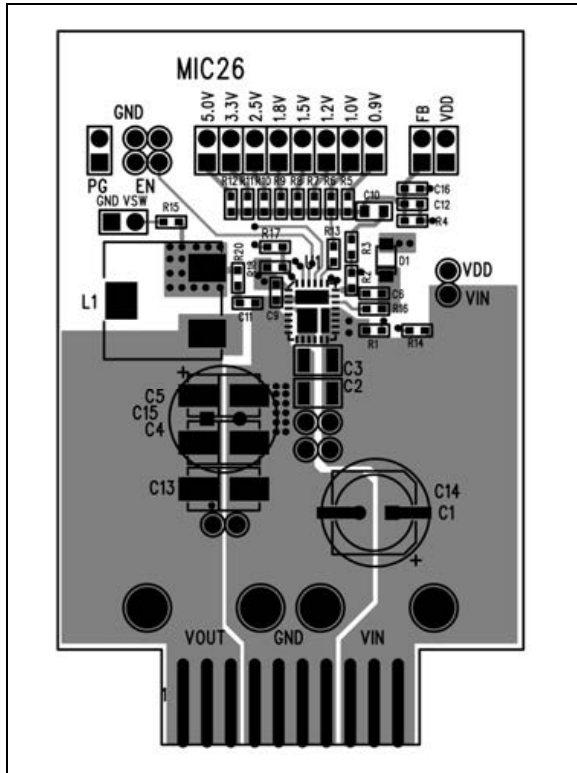


FIGURE 8-1: Evaluation Board Top Layer.

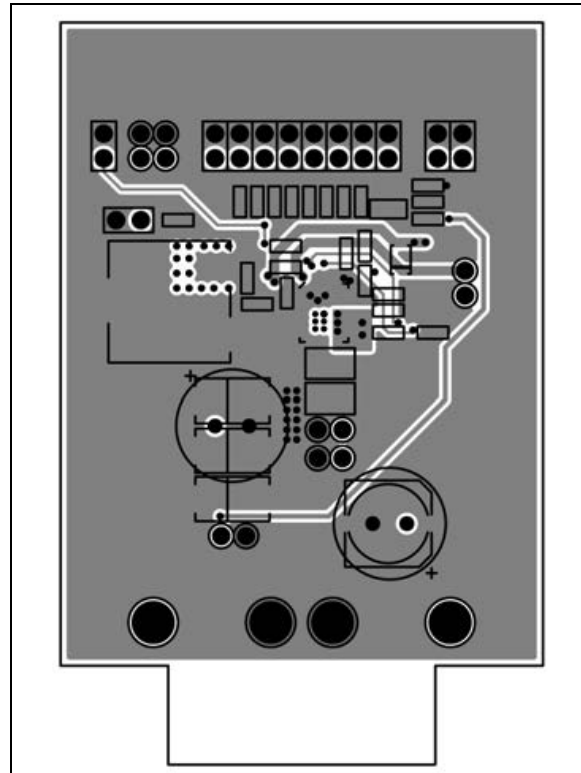


FIGURE 8-3: Eval. Board Mid-Layer 2.

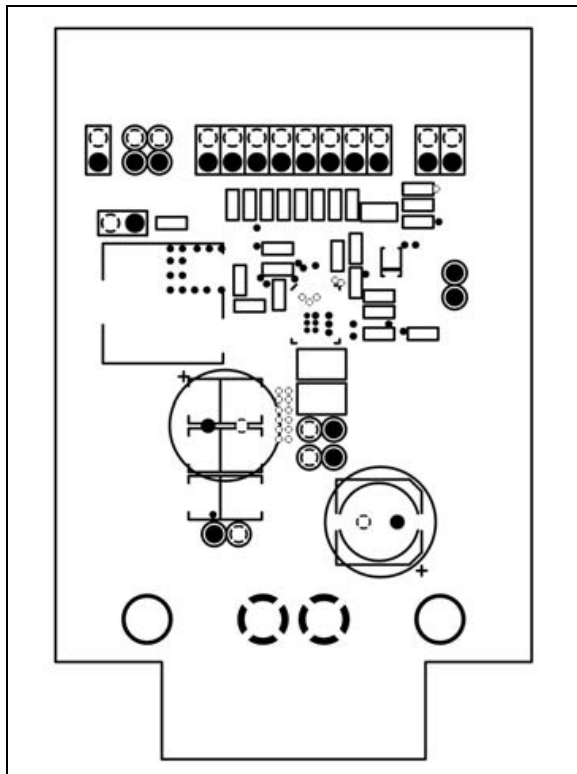


FIGURE 8-2: Eval. Board Mid-Layer 1 (Ground Plane).

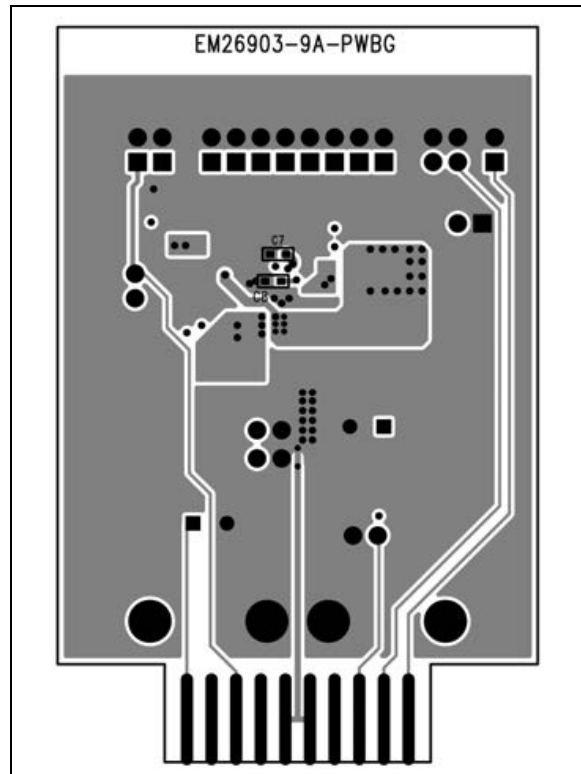
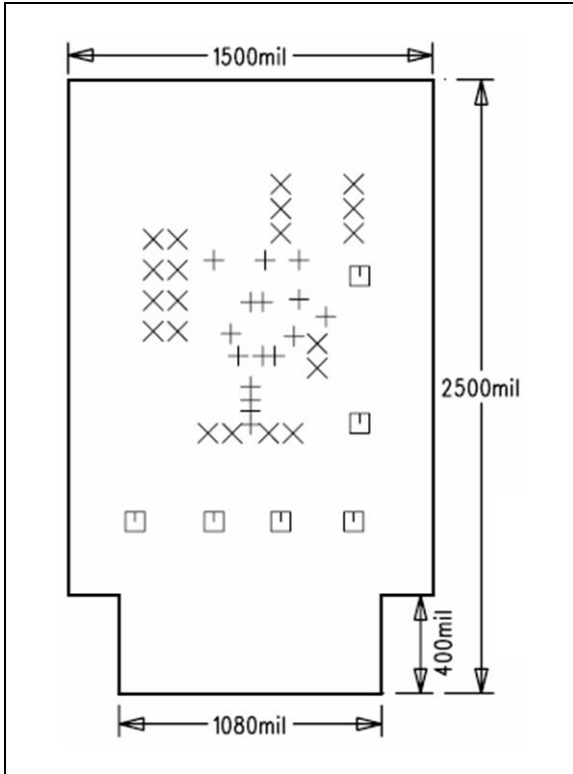


FIGURE 8-4: Evaluation Board Bottom Layer.



**FIGURE 8-5:** EV Board Dimensions.

# MIC261201

---

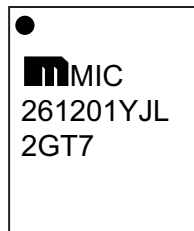
## 9.0 PACKAGING INFORMATION

### 9.1 Package Marking Information

28-Lead VQFN\*



Example



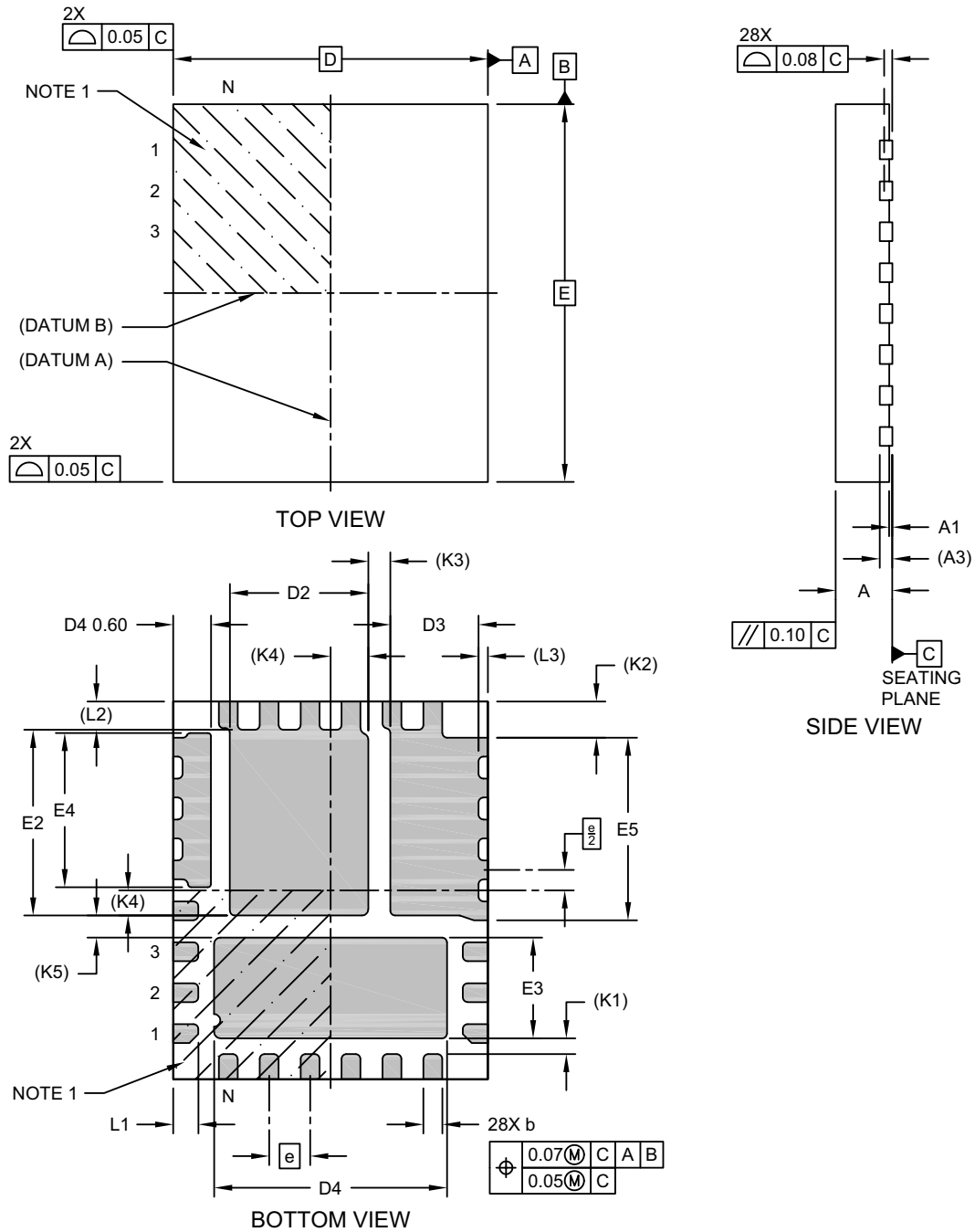
<b>Legend:</b>	XX...X	Product code or customer-specific information
	Y	Year code (last digit of calendar year)
	YY	Year code (last 2 digits of calendar year)
	WW	Week code (week of January 1 is week '01')
	NNN	Alphanumeric traceability code
	(e3)	Pb-free JEDEC® designator for Matte Tin (Sn)
	*	This package is Pb-free. The Pb-free JEDEC designator ((e3)) can be found on the outer packaging for this package.
	•, ▲, ▼	Pin one index is identified by a dot, delta up, or delta down (triangle mark).
<b>Note:</b>	In the event the full Microchip part number cannot be marked on one line, it will be carried over to the next line, thus limiting the number of available characters for customer-specific information. Package may or may not include the corporate logo.	
	Underbar ( _ ) symbol may not be to scale.	

**Note:** If the full seven-character YYWWNNN code cannot fit on the package, the following truncated codes are used based on the available marking space:  
6 Characters = YWWNNN; 5 Characters = WWNNN; 4 Characters = WNNN; 3 Characters = NNN;  
2 Characters = NN; 1 Character = N

## 28-Lead VQFN 5 mm x 6 mm Package Outline and Recommended Land Pattern

### 28-Lead Very Thin Plastic Quad Flat, No Lead Package (PKA) - 5x6x0.9 mm Body [VQFN] With Multiple Exposed Pads and Fused Terminals; Micrel Legacy QFN56-28LD-PL-1

**Note:** For the most current package drawings, please see the Microchip Packaging Specification located at <http://www.microchip.com/packaging>

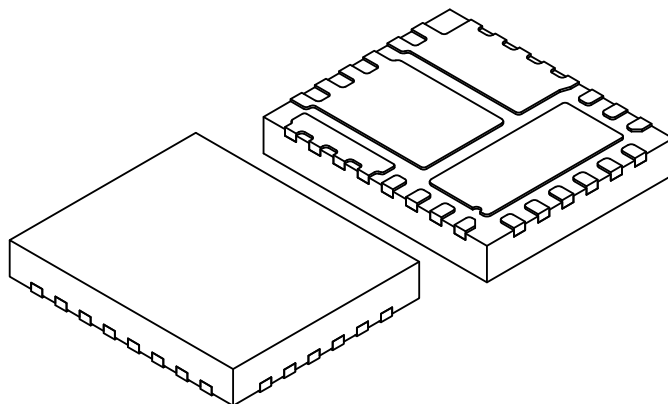


Microchip Technology Drawing C04-1120 Rev A Sheet 1 of 2

# MIC261201

## 28-Lead Very Thin Plastic Quad Flat, No Lead Package (PKA) - 5x6x0.9 mm Body [VQFN] With Multiple Exposed Pads and Fused Terminals; Micrel Legacy QFN56-28LD-PL-1

**Note:** For the most current package drawings, please see the Microchip Packaging Specification located at <http://www.microchip.com/packaging>



Dimension Limits	Units	MILLIMETERS		
		MIN	NOM	MAX
Number of Terminals	N	28		
Pitch	e	0.65 BSC		
Overall Height	A	0.00	0.02	0.05
Standoff	A1	0.80	0.85	0.85
Terminal Thickness	A3	0.20 REF		
Overall Length	D	5.00 BSC		
Exposed Pad Length	D2	2.15	2.20	2.25
Exposed Pad Length	D3	1.35	1.40	1.45
Exposed Pad Length	D4	3.65	3.70	3.75
Overall Width	E	6.00 BSC		
Exposed Pad Width	E2	2.90	2.95	3.00
Exposed Pad Width	E3	1.575	1.60	1.625
Exposed Pad Width	E4	2.40	2.45	2.50
Exposed Pad Width	E5	2.85	2.90	2.95
Terminal Width	b	0.25	0.30	0.35
Terminal Length	L1	0.35	0.40	0.45
Terminal Length	L2	0.45 REF		
Terminal Length	L3	0.15 REF		
Terminal to Exposed Pad	K1	0.25 REF		
Body Edge to Exposed Pad	K2	0.575 REF		
Exposed Pad to Exposed Pad	K3	0.035 REF		
Exposed Pad Offset	K4	0.40 REF		
Exposed Pad to Exposed Pad	K5	0.35 REF		

**Notes:**

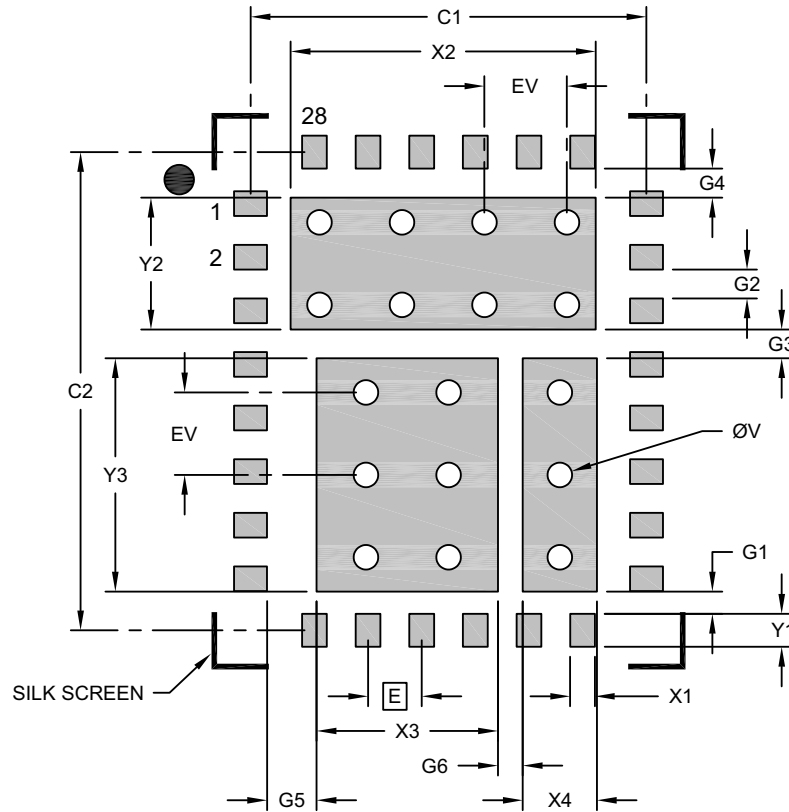
- Pin 1 visual index feature may vary, but must be located within the hatched area.
- Package is saw singulated
- Dimensioning and tolerancing per ASME Y14.5M  
BSC: Basic Dimension. Theoretically exact value shown without tolerances.  
REF: Reference Dimension, usually without tolerance, for information purposes only.

Microchip Technology Drawing C04-1120 Rev A Sheet 2 of 2



## 28-Lead Very Thin Plastic Quad Flat, No Lead Package (PKA) - 5x6x0.9 mm Body [VQFN] With Multiple Exposed Pads and Fused Terminals; Micrel Legacy QFN56-28LD-PL-1

**Note:** For the most current package drawings, please see the Microchip Packaging Specification located at <http://www.microchip.com/packaging>



### RECOMMENDED LAND PATTERN

Dimension	Units	MILLIMETERS			Dimension	Units	MILLIMETERS		
		MIN	NOM	MAX			MIN	NOM	MAX
Contact Pitch	E	0.65 BSC			Contact Pad Spacing	C2			
Center Pad Width	X2			3.70	Contact Pad to Center Pad	G1	0.12		
Center Pad Width	X3			2.20	Contact Pad to Contact Pad	G2	0.35		
Center Pad Width	X4			0.90	Center Pad to Center Pad	G3	0.35		
Center Pad Length	Y2			1.60	Contact Pad to Center Pad	G4	0.35		
Center Pad Length	Y3			2.83	Contact Pad to Center Pad	G5	0.60		
Contact Pad Width	X1			0.30	Center Pad to Center Pad	G6	0.13		
Contact Pad Length	Y1			0.40	Thermal Via Diameter	V		0.30	
Contact Pad Spacing	C1		4.80		Thermal Via Pitch	EV		1.00	

**Notes:**

1. Dimensioning and tolerancing per ASME Y14.5M  
BSC: Basic Dimension. Theoretically exact value shown without tolerances.
2. For best soldering results, thermal vias, if used, should be filled or tented to avoid solder loss during reflow process

Microchip Technology Drawing C04-3120 Rev A

# MIC261201

---

---

NOTES:

## APPENDIX A: REVISION HISTORY

### Revision A (April 2022)

- Converted Micrel document MIC261201 to Microchip data sheet DS20006660A.
- Minor text changes throughout.

# MIC261201

---

---

NOTES:

## PRODUCT IDENTIFICATION SYSTEM

To order or obtain information, e.g., on pricing or delivery, contact your local Microchip representative or sales office.

<u>Part Number</u>	<u>X</u>	<u>XX</u>	<u>-XX</u>
Device	Temp. Range	Package	Media Type
<b>Device:</b>	MIC261201:	28V, 12A Hyper Speed Control <sup>®</sup> Synchronous DC/DC Buck Regulator	
<b>Temperature Range:</b>	Y =	-40°C to +125°C	
<b>Package:</b>	JL =	28-Lead VQFN	
<b>Media Type:</b>	TR =	1,000/Reel	

**Examples:**

a) MIC261201YJL-TR: MIC261201, -40°C to +125°C Temp. Range, 28-Lead VQFN, 1000/Reel

**Note 1:** Tape and Reel identifier only appears in the catalog part number description. This identifier is used for ordering purposes and is not printed on the device package. Check with your Microchip Sales Office for package availability with the Tape and Reel option.

# MIC261201

---

---

NOTES:

---

---

**Note the following details of the code protection feature on Microchip products:**

- Microchip products meet the specifications contained in their particular Microchip Data Sheet.
- Microchip believes that its family of products is secure when used in the intended manner, within operating specifications, and under normal conditions.
- Microchip values and aggressively protects its intellectual property rights. Attempts to breach the code protection features of Microchip product is strictly prohibited and may violate the Digital Millennium Copyright Act.
- Neither Microchip nor any other semiconductor manufacturer can guarantee the security of its code. Code protection does not mean that we are guaranteeing the product is “unbreakable”. Code protection is constantly evolving. Microchip is committed to continuously improving the code protection features of our products.

---

This publication and the information herein may be used only with Microchip products, including to design, test, and integrate Microchip products with your application. Use of this information in any other manner violates these terms. Information regarding device applications is provided only for your convenience and may be superseded by updates. It is your responsibility to ensure that your application meets with your specifications. Contact your local Microchip sales office for additional support or, obtain additional support at <https://www.microchip.com/en-us/support/design-help/client-support-services>.

THIS INFORMATION IS PROVIDED BY MICROCHIP "AS IS". MICROCHIP MAKES NO REPRESENTATIONS OR WARRANTIES OF ANY KIND WHETHER EXPRESS OR IMPLIED, WRITTEN OR ORAL, STATUTORY OR OTHERWISE, RELATED TO THE INFORMATION INCLUDING BUT NOT LIMITED TO ANY IMPLIED WARRANTIES OF NON-INFRINGEMENT, MERCHANTABILITY, AND FITNESS FOR A PARTICULAR PURPOSE, OR WARRANTIES RELATED TO ITS CONDITION, QUALITY, OR PERFORMANCE.

IN NO EVENT WILL MICROCHIP BE LIABLE FOR ANY INDIRECT, SPECIAL, PUNITIVE, INCIDENTAL, OR CONSEQUENTIAL LOSS, DAMAGE, COST, OR EXPENSE OF ANY KIND WHATSOEVER RELATED TO THE INFORMATION OR ITS USE, HOWEVER CAUSED, EVEN IF MICROCHIP HAS BEEN ADVISED OF THE POSSIBILITY OR THE DAMAGES ARE FORESEEABLE. TO THE FULLEST EXTENT ALLOWED BY LAW, MICROCHIP'S TOTAL LIABILITY ON ALL CLAIMS IN ANY WAY RELATED TO THE INFORMATION OR ITS USE WILL NOT EXCEED THE AMOUNT OF FEES, IF ANY, THAT YOU HAVE PAID DIRECTLY TO MICROCHIP FOR THE INFORMATION.

Use of Microchip devices in life support and/or safety applications is entirely at the buyer's risk, and the buyer agrees to defend, indemnify and hold harmless Microchip from any and all damages, claims, suits, or expenses resulting from such use. No licenses are conveyed, implicitly or otherwise, under any Microchip intellectual property rights unless otherwise stated.

For information regarding Microchip's Quality Management Systems, please visit [www.microchip.com/quality](http://www.microchip.com/quality).

**Trademarks**

The Microchip name and logo, the Microchip logo, Adaptec, AnyRate, AVR, AVR logo, AVR Freaks, BesTime, BitCloud, CryptoMemory, CryptoRF, dsPIC, flexPWR, HELDO, IGLOO, JukeBlox, KeeLoq, Kleer, LANCheck, LinkMD, maXStylus, maXTouch, MediaLB, megaAVR, Microsemi, Microsemi logo, MOST, MOST logo, MPLAB, OptoLyzer, PIC, picoPower, PICSTART, PIC32 logo, PolarFire, Prochip Designer, QTouch, SAM-BA, SenGenuity, SpyNIC, SST, SST Logo, SuperFlash, Symmetricom, SyncServer, Tachyon, TimeSource, tinyAVR, UNI/O, Vectron, and XMEGA are registered trademarks of Microchip Technology Incorporated in the U.S.A. and other countries.

AgileSwitch, APT, ClockWorks, The Embedded Control Solutions Company, EtherSynch, Flashtec, Hyper Speed Control, HyperLight Load, IntelliMOS, Libero, motorBench, mTouch, Powermite 3, Precision Edge, ProASIC, ProASIC Plus, ProASIC Plus logo, QuietWire, SmartFusion, SyncWorld, Temux, TimeCesium, TimeHub, TimePictra, TimeProvider, TrueTime, WinPath, and ZL are registered trademarks of Microchip Technology Incorporated in the U.S.A.

Adjacent Key Suppression, AKS, Analog-for-the-Digital Age, Any Capacitor, AnyIn, AnyOut, Augmented Switching, BlueSky, BodyCom, CodeGuard, CryptoAuthentication, CryptoAutomotive, CryptoCompanion, CryptoController, dsPICDEM, dsPICDEM.net, Dynamic Average Matching, DAM, ECAN, Espresso T1S, EtherGREEN, GridTime, IdealBridge, In-Circuit Serial Programming, ICSP, INICnet, Intelligent Paralleling, Inter-Chip Connectivity, JitterBlocker, Knob-on-Display, maxCrypto, maxView, memBrain, Mindi, MiWi, MPASM, MPF, MPLAB Certified logo, MPLIB, MPLINK, MultiTRAK, NetDetach, NVM Express, NVMe, Omniscient Code Generation, PICDEM, PICDEM.net, PICkit, PICtail, PowerSmart, PureSilicon, QMatrix, REAL ICE, Ripple Blocker, RTAX, RTG4, SAM-ICE, Serial Quad I/O, simpleMAP, SimpliPHY, SmartBuffer, SmartHLS, SMART-I.S., storClad, SQI, SuperSwitcher, SuperSwitcher II, Switchtec, SynchroPHY, Total Endurance, TSHARC, USBCheck, VariSense, VectorBlox, VeriPHY, ViewSpan, WiperLock, XpressConnect, and ZENA are trademarks of Microchip Technology Incorporated in the U.S.A. and other countries.

SQTP is a service mark of Microchip Technology Incorporated in the U.S.A.

The Adaptec logo, Frequency on Demand, Silicon Storage Technology, Symmcom, and Trusted Time are registered trademarks of Microchip Technology Inc. in other countries.

GestIC is a registered trademark of Microchip Technology Germany II GmbH & Co. KG, a subsidiary of Microchip Technology Inc., in other countries.

All other trademarks mentioned herein are property of their respective companies.

© 2022, Microchip Technology Incorporated and its subsidiaries.

All Rights Reserved.

ISBN: 978-1-6683-0170-8



# MICROCHIP

## Worldwide Sales and Service

### AMERICAS

**Corporate Office**  
2355 West Chandler Blvd.  
Chandler, AZ 85224-6199  
Tel: 480-792-7200  
Fax: 480-792-7277  
Technical Support:  
<http://www.microchip.com/support>  
Web Address:  
[www.microchip.com](http://www.microchip.com)

#### Atlanta

Duluth, GA  
Tel: 678-957-9614  
Fax: 678-957-1455

#### Austin, TX

Tel: 512-257-3370

#### Boston

Westborough, MA  
Tel: 774-760-0087  
Fax: 774-760-0088

#### Chicago

Itasca, IL  
Tel: 630-285-0071  
Fax: 630-285-0075

#### Dallas

Addison, TX  
Tel: 972-818-7423  
Fax: 972-818-2924

#### Detroit

Novi, MI  
Tel: 248-848-4000

#### Houston, TX

Tel: 281-894-5983

#### Indianapolis

Noblesville, IN  
Tel: 317-773-8323  
Fax: 317-773-5453  
Tel: 317-536-2380

#### Los Angeles

Mission Viejo, CA  
Tel: 949-462-9523  
Fax: 949-462-9608  
Tel: 951-273-7800

#### Raleigh, NC

Tel: 919-844-7510

#### New York, NY

Tel: 631-435-6000

#### San Jose, CA

Tel: 408-735-9110  
Tel: 408-436-4270

#### Canada - Toronto

Tel: 905-695-1980  
Fax: 905-695-2078

### ASIA/PACIFIC

**Australia - Sydney**  
Tel: 61-2-9868-6733

**China - Beijing**  
Tel: 86-10-8569-7000

**China - Chengdu**  
Tel: 86-28-8665-5511

**China - Chongqing**  
Tel: 86-23-8980-9588

**China - Dongguan**  
Tel: 86-769-8702-9880

**China - Guangzhou**  
Tel: 86-20-8755-8029

**China - Hangzhou**  
Tel: 86-571-8792-8115

**China - Hong Kong SAR**  
Tel: 852-2943-5100

**China - Nanjing**  
Tel: 86-25-8473-2460

**China - Qingdao**  
Tel: 86-532-8502-7355

**China - Shanghai**  
Tel: 86-21-3326-8000

**China - Shenyang**  
Tel: 86-24-2334-2829

**China - Shenzhen**  
Tel: 86-755-8864-2200

**China - Suzhou**  
Tel: 86-186-6233-1526

**China - Wuhan**  
Tel: 86-27-5980-5300

**China - Xian**  
Tel: 86-29-8833-7252

**China - Xiamen**  
Tel: 86-592-2388138

**China - Zhuhai**  
Tel: 86-756-3210040

### ASIA/PACIFIC

**India - Bangalore**  
Tel: 91-80-3090-4444

**India - New Delhi**  
Tel: 91-11-4160-8631

**India - Pune**  
Tel: 91-20-4121-0141

**Japan - Osaka**  
Tel: 81-6-6152-7160

**Japan - Tokyo**  
Tel: 81-3-6880-3770

**Korea - Daegu**  
Tel: 82-53-744-4301

**Korea - Seoul**  
Tel: 82-2-554-7200

**Malaysia - Kuala Lumpur**  
Tel: 60-3-7651-7906

**Malaysia - Penang**  
Tel: 60-4-227-8870

**Philippines - Manila**  
Tel: 63-2-634-9065

**Singapore**  
Tel: 65-6334-8870

**Taiwan - Hsin Chu**  
Tel: 886-3-577-8366

**Taiwan - Kaohsiung**  
Tel: 886-7-213-7830

**Taiwan - Taipei**  
Tel: 886-2-2508-8600

**Thailand - Bangkok**  
Tel: 66-2-694-1351

**Vietnam - Ho Chi Minh**  
Tel: 84-28-5448-2100

### EUROPE

**Austria - Wels**  
Tel: 43-7242-2244-39  
Fax: 43-7242-2244-393

**Denmark - Copenhagen**  
Tel: 45-4485-5910  
Fax: 45-4485-2829

**Finland - Espoo**  
Tel: 358-9-4520-820

**France - Paris**  
Tel: 33-1-69-53-63-20  
Fax: 33-1-69-30-90-79

**Germany - Garching**  
Tel: 49-8931-9700

**Germany - Haan**  
Tel: 49-2129-3766400

**Germany - Heilbronn**  
Tel: 49-7131-72400

**Germany - Karlsruhe**  
Tel: 49-721-625370

**Germany - Munich**  
Tel: 49-89-627-144-0  
Fax: 49-89-627-144-44

**Germany - Rosenheim**  
Tel: 49-8031-354-560

**Israel - Ra'anana**  
Tel: 972-9-744-7705

**Italy - Milan**  
Tel: 39-0331-742611  
Fax: 39-0331-466781

**Italy - Padova**  
Tel: 39-049-7625286

**Netherlands - Drunen**  
Tel: 31-416-690399  
Fax: 31-416-690340

**Norway - Trondheim**  
Tel: 47-7288-4388

**Poland - Warsaw**  
Tel: 48-22-3325737

**Romania - Bucharest**  
Tel: 40-21-407-87-50

**Spain - Madrid**  
Tel: 34-91-708-08-90  
Fax: 34-91-708-08-91

**Sweden - Gothenberg**  
Tel: 46-31-704-60-40

**Sweden - Stockholm**  
Tel: 46-8-5090-4654

**UK - Wokingham**  
Tel: 44-118-921-5800  
Fax: 44-118-921-5820