

Features

Regulated Converter

- Wide input range 85-264VAC / 85-305VAC
- Standby mode optimized PSU (ENER Lot 6)
- Operating Altitude up to 5000m
- Operating temperature range: -40°C to +85°C
- Class II installations (without FG)
- EMC compliant without external components
- No load power consumption 40mW typ.



RAC20-K

20 Watt
2" x 1"
Single and Dual Output

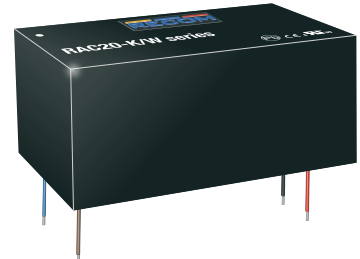

IEC/EN62368-1 certified
UL62368-1 certified
CAN/CSA-C22.2 No. 62368-1-14 certified
IEC/EN60335 certified
IEC/EN61558-1 certified
IEC/EN61558-2-16 certified
IEC/EN61204-3 compliant
EN55032/14 compliant
EN55024 compliant
CB Report

Description

The RAC20-K series are highly efficient PCB-mount power conversion modules with ultra-low energy losses especially in light load conditions, making them a benchmark for always-on and standby mode operations, which are typically coming along with IoT and smart applications. The power supply units cover worldwide mains input range of 85VAC up to 305VAC and come with international safety certifications for industrial, AV and ITE as well as household standards. These AC/DC modules operate in a temperature range of -40°C to +85°C with up to 5000m operating altitude and offer fully protected single or dual outputs as well as EMC class B compliance without the need of any external components in floating connections. Modified versions for OVC III requirements are available on request.

Selection Guide

Part Number	Input Voltage Range [VAC]	Output Voltage [VDC]	Output Current [mA]	Efficiency typ ⁽¹⁾ [%]	Max. Capacitive Load ⁽²⁾ [µF]
RAC20-05SK ^(3,4)	85-264 / 85-305	5	4000	84	10000
RAC20-12SK ^(3,4)	85-264 / 85-305	12	1670	86	8000
RAC20-15SK ^(3,4)	85-264 / 85-305	15	1333	86	1500
RAC20-24SK ^(3,4)	85-264 / 85-305	24	830	85	1000
RAC20-48SK ⁽³⁾	85-264	48	410	85	330
RAC20-12DK ⁽³⁾	85-264 / 85-305	±12	±833	84	±1200
RAC20-15DK ⁽³⁾	85-264 / 85-305	±15	±670	84	±1000

Notes:

Note1: Efficiency is tested at 230VAC input and constant resistive load at +25°C ambient
Note2: Max Cap Load is tested at nominal input and full resistive load

Model Numbering

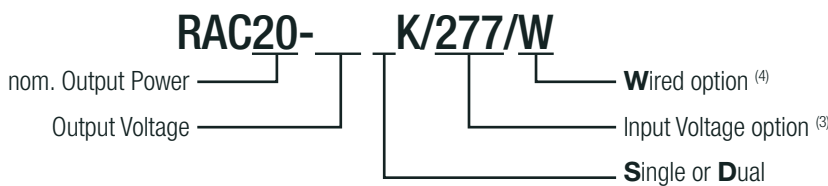

Notes:

Note3: Add suffix "/277" for wider input voltage range (85-305VAC)
For detail information refer to "Nominal Input Voltage ^(5, 6)"
without suffix= standard input range 85-264VAC
Note4: Add suffix „W" for wired version (single output only, "277/W" combination on request)
without suffix= standard THT version
refer to "Model Matrix"

Model Matrix			
Model	/277	/W	/277/W
5	x	x	on request
12	x	x	on request
15	x	x	on request
24	x	x	on request
48	N/A	x	on request
12D	x	N/A	N/A
15D	x	N/A	N/A

x = standard portfolio / on request = MOQ may apply on project base / N/A= not available

Specifications (measured @ Ta= 25°C, nom. Vin, full load and after warm-up unless otherwise stated)

BASIC CHARACTERISTICS					
Parameter	Condition		Min.	Typ.	Max.
Internal Input Filter					Pi type
Nominal Input Voltage ^(5, 6)	50/60Hz	standard version "/277" version	100VAC		240VAC 277VAC
Operating Range	standard	47-63Hz DC	85VAC 120VDC		264VAC 370VDC
	/277 Versions	47-63Hz DC	85VAC 120VDC		305VAC 430VDC
Input Current	115VAC 230VAC 277VAC				450mA 400mA 300mA
Inrush Current	cold start at +25°C	115VAC 230VAC 277VAC			20A 40A 50A
No Load Power Consumption	230VAC			40mW	
ErP Lot 6 Standby Mode Conformity (Output Load Capability)	Input Power =		0.5W 1.0W 2.0W		0.3W 0.7W 1.6W
Input Frequency Range	AC Input		47Hz		63Hz
Minimum Load ⁽⁹⁾	single dual (required for regulation on both outputs)		0%	10%	
Power Factor	115VAC 230VAC 277VAC		0.6 0.5 0.45		
Start-up Time				150ms	
Rise Time				40ms	
Hold-up Time	115VAC 230VAC 277VAC			12ms 60ms 90ms	
Internal Operating Frequency					100kHz
Output Ripple and Noise ⁽⁷⁾	20MHz BW	5Vout others		100mVp-p	1% of Vout

Notes:

Note5: The products were submitted for safety files at AC-Input operation

Note6: Refer to **"Derating Graph"**

Note7: Measurements are made with a 1.0µF MLCC across output (low ESR)

Efficiency vs. Load

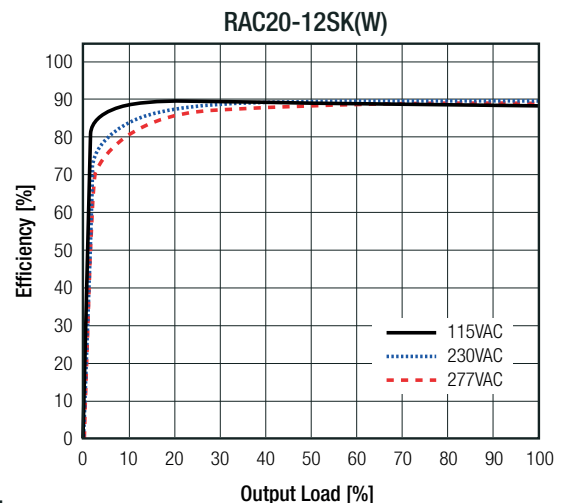
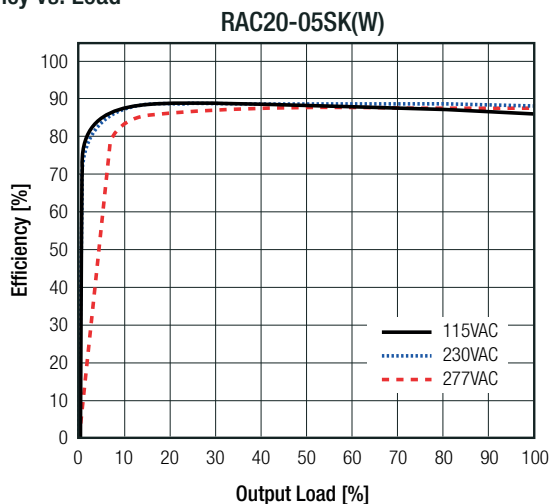

continued on next page

Specifications (measured @ Ta= 25°C, nom. Vin, full load and after warm-up unless otherwise stated)

Efficiency vs. Load

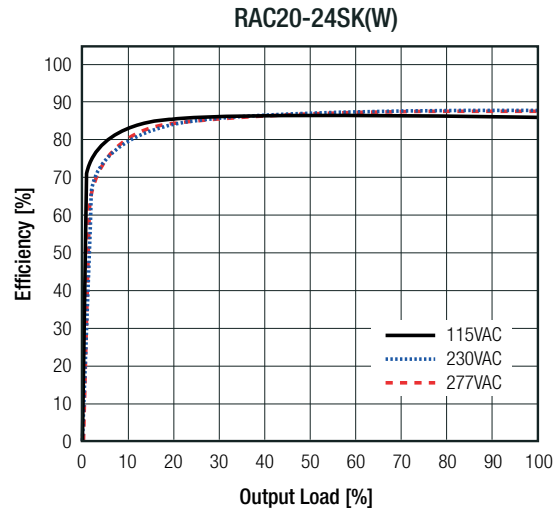
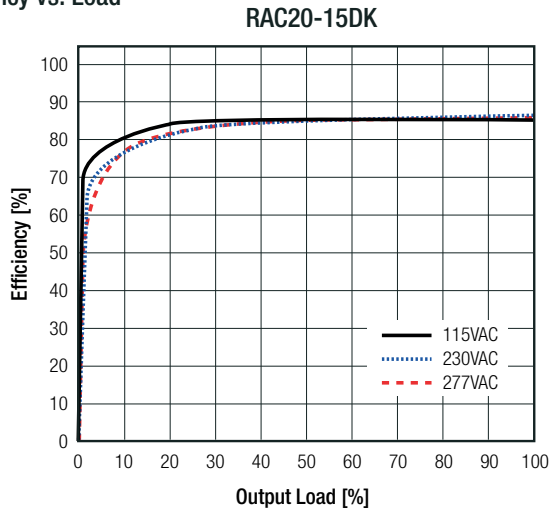

REGULATIONS

Parameter	Condition	Value
Output Accuracy		±2.0% typ.
Line Regulation	low line to high line	±0.5% typ.
Load Regulation [®]	10% to 100% load	2.0% typ.
Cross Regulation	dual output only	±10.0% typ.
Transient Response	25% load step change recovery time	4.0% max. 500µs typ.

Notes:

Note8: Operation below 10% load will not harm the converter, but specifications may not be met

Deviation vs. Load

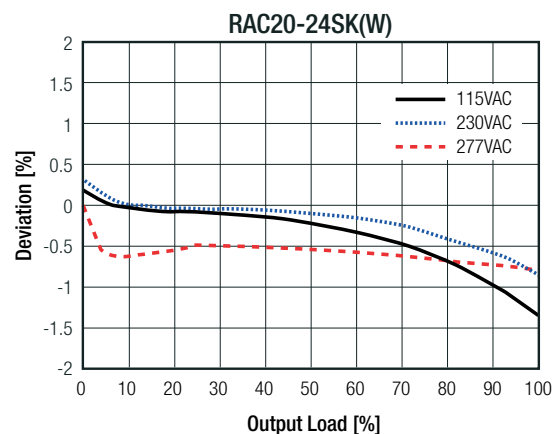
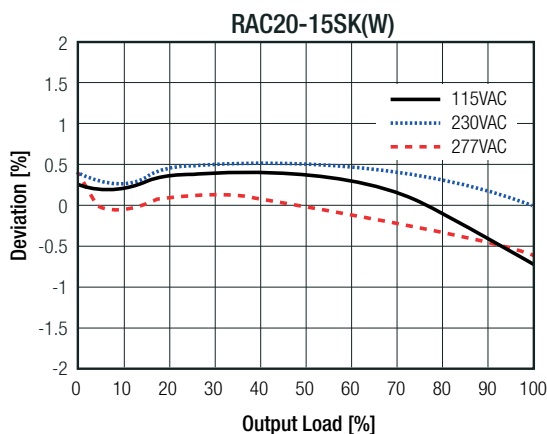
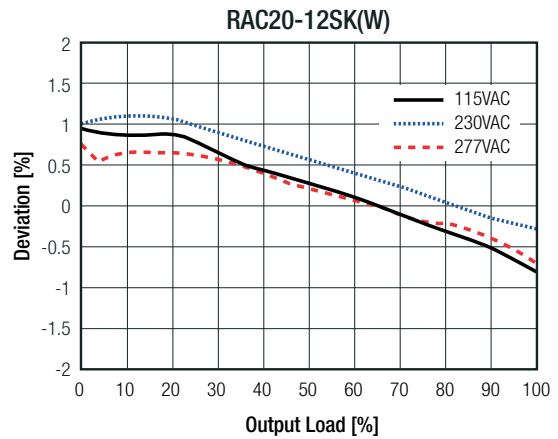
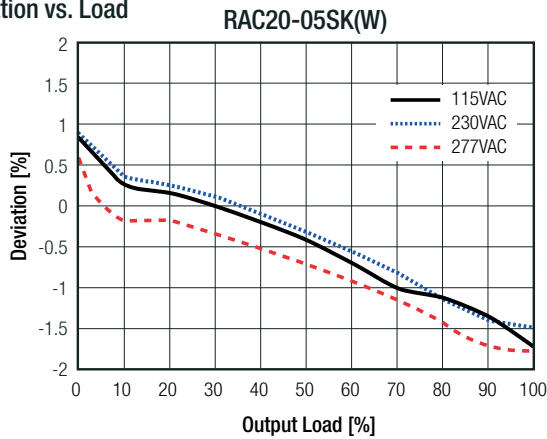

Specifications (measured @ Ta= 25°C, nom. Vin, full load and after warm-up unless otherwise stated)

PROTECTIONS			
Parameter	Type		Value
Input Fuse ⁽⁹⁾	internal	standard version	T3.15A, slow blow type
		/277 versions	non, refer to "Protection Circuit"
Short Circuit Protection (SCP)	below 100mΩ		hiccup, auto recovery
Over Voltage Protection (OVP)			150% - 195%, latch off mode
Over Current Protection (OCP)			110% - 130%, hiccup mode
Over Voltage Category ⁽¹⁰⁾			OVCII
Class of Equipment			Class II
Isolation Voltage ⁽¹¹⁾	I/P to O/P	tested for 1 minute	3kVAC
Isolation Resistance		V _{iso} = 500VDC	1GΩ min.
Isolation Capacitance			100pF max.
Insulation Grade			reinforced
Leakage Current			0.25mA max.

Notes:

- Note9: Refer to local safety regulations if input over-current protection is also required
/277 Versions have no fuse integrated, it is recommended to use an external fuse recognized by UL or evaluated by TUV, refer to below schematic
- Note10: For OVC III requirements please contact RECOM tech support for advice
- Note11: For repeat Hi-Pot testing, reduce the time and/or the test voltage

Protection Circuit for /277 Versions

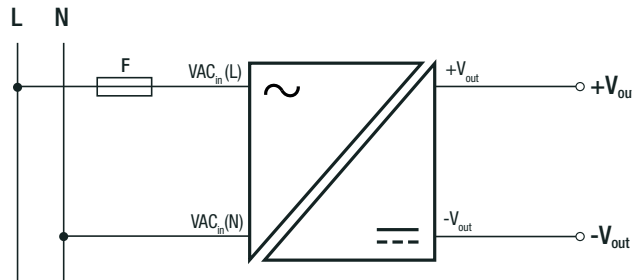

ENVIRONMENTAL			
Parameter	Condition		Value
Operating Temperature Range	@ natural convection 0.1m/s	full load	-40°C to +55°C
		refer to "Derating Graph"	-40°C to +85°C
Maximum Case Temperature			+95°C
Temperature Coefficient			0.05%/K
Operating Altitude ⁽¹²⁾			5000m
Operating Humidity	non-condensing		20% - 90% RH max.
IP Rating			IP20
Pollution Degree			PD2
Vibration	according to MIL-STD-202G		10-500Hz, 2G 10min./1cycle, period 60min. along x,y,z axes
Design Lifetime	+25°C		130 x 10 ³ hours
	+55°C		16 x 10 ³ hours
MTBF	according to MIL-HDBK-217F, G.B.	+25°C	>1196 x 10 ³ hours
		+40°C	>955 x 10 ³ hours

Notes:

- Note12: Recognized by safety agency for safe operation up to 5000m. High altitude operation may impact the performance and lifetime.
Please contact RECOM tech support for advice

continued on next page

Specifications (measured @ Ta= 25°C, nom. Vin, full load and after warm-up unless otherwise stated)

Derating Graph

(@ Chamber and natural convection 0.1 m/s)

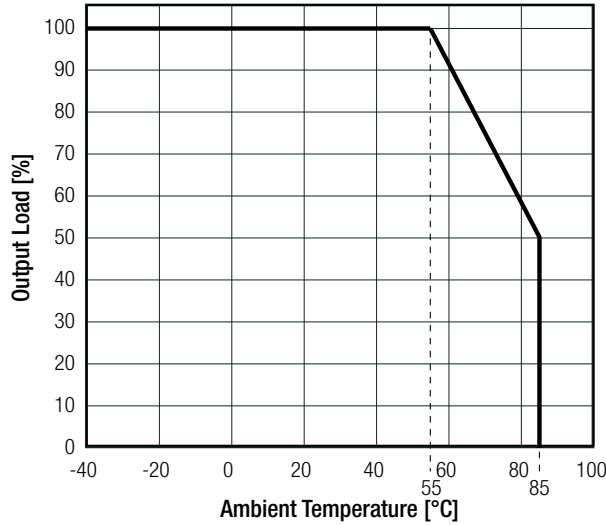

Notes:

Note13: Output power derating for Line-input of less than 90VAC (de-rate linearly from 100% at 90VAC to 90% at 85VAC)

SAFETY AND CERTIFICATIONS

Certificate Type (Safety)	Report / File Number	Standard
Audio/Video, information and communication technology equipment - Safety requirements	E224736	UL62368-1, 2nd Edition, 2014 CAN/CSA C22.2 Nr. 62368-1-14, 2nd Ed. 2014
Audio/Video, information and communication technology equipment - Safety requirements (CB Scheme)	E491408-A6008-CB-1	IEC62368-1:2014 2nd Edition
Audio/Video, information and communication technology equipment - Safety requirements (LVD)		EN62368-1:2014 + A11:2017
Household and similar electrical appliances – Safety – Part 1: General requirements	LCS180508046AS	IEC60335-1:2010 + AMD2:2016 + COR1:2016 EN60335-1:2012 + A11:2014 + A13:2017
Safety of power transformers, power supplies, reactors and similar products for supply voltages up to 1100 V (CB Scheme)	50198090 001	IEC61558-1:2005 2nd Edition + A1:2009
Safety of power transformers, power supplies, reactors and similar products for supply voltages up to 1100 V		EN61558-1:2005 + A1:2009
Safety of power transformers, power supplies, reactors and similar products for supply voltages up to 1100 V Part 2: Particular requirements (CB Scheme)	50198090 001	IEC61558-2-16:2009 1st Edition + A1:2013
Safety of power transformers, power supplies, reactors and similar products for supply voltages up to 1100 V Part 2: Particular requirements		EN61558-2-16:2009 + A1:2013
Safety requirements for power electronic converter systems and equipment - Part 1: General (CB Scheme)	CN21R4QC001	IEC62477-1:2012 + A1:2016, 1st Edition
Safety requirements for power electronic converter systems and equipment - Part 1: General (LVD)		EN62477-1:2012 + A11:2014 + A1:2017
EAC	RU-AT.03.67361	TP TC 004/2011
RoHS2		RoHS-2011/65/EU + AM-2015/863

EMC Compliance	Condition	Standard / Criterion
Low voltage power supplies, d.c. output Part 3: Electromagnetic compatibility (EMC)		IEC/EN61204-3:2018, Class B
Electromagnetic compatibility of multimedia equipment - Emission requirements	without external filter	EN55032:2015, Class B
Electromagnetic compatibility of household appliances, electric tools and similar apparatus - Emission Requirements		EN55014-1:2006 + A2:2011
Information technology equipment - Immunity characters - Limits and methods of measurement		EN55024:2010 + A1:2015

continued on next page

Specifications (measured @ Ta= 25°C, nom. Vin, full load and after warm-up unless otherwise stated)

EMC Compliance	Condition	Standard / Criterion
Electromagnetic compatibility of household appliances, electric tools and similar apparatus - Immunity Requirements		EN55014-2:2015
ESD Electrostatic discharge immunity test	Air ±8kV, Contact ±4kV	EN61000-4-2:2009, Criteria B
Radiated, radio-frequency, electromagnetic field immunity test	80MHz - 6GHz: 10V/m 1.4GHz - 2GHz: 3V/m 2.0GHz - 2.7GHz: 1V/m	EN61000-4-3:2006 + A1:2008, Criteria A
Fast Transient and Burst Immunity	AC Port: ±2.0kV DC Port: ±2.0kV	EN61000-4-4:2012, Criteria B
Surge Immunity	AC Port: L-N ±1.0kV DC Port: ±0.5kV	EN61000-4-5:2014 + A1:2017, Criteria B
Immunity to conducted disturbances, induced by radio-frequency fields	AC Port: 10V DC Port: 10V	EN61000-4-6:2014, Criteria A
Power Magnetic Field Immunity	50Hz, 30A/m	EN61000-4-8:2010, Criteria A
Voltage Dips and Interruptions	Voltage Dips 20% Voltage Dips 30% Voltage Dips 60% Voltage Dips 100% Voltage Interruptions > 95%	EN61000-4-11:2004 + A1:2017, Criteria C EN61000-4-11:2004 + A1:2017, Criteria C EN61000-4-11:2004 + A1:2017, Criteria C EN61000-4-11:2004 + A1:2017, Criteria B EN61000-4-11:2004 + A1:2017, Criteria C
Limits of Voltage Fluctuations & Flicker		EN61000-3-3:2013
Limitations on the amount of electromagnetic interference allowed from digital and electronic devices		FCC 47 CFR Part 15 Subpart B, Class B
American National Standard for Methods of Measurement of Radio-Noise Emissions from Low-Voltage Electrical and Electronic Equipment in the Range of 9 kHz to 40 GHz		ANSI C63.4-2014, Class B
<p>Notes:</p> <p>Note14: If output is connected to GND, please contact RECOM tech support for advice</p>		

DIMENSION AND PHYSICAL CHARACTERISTICS		
Parameter	Type	Value
Material	case	black plastic, (UL94V-0)
	potting	silicone, (UL94V-0)
	PCB	FR4, (UL94V-0)
	baseplate	black plastic, (UL94V-0)
Dimension (LxWxH)		52.5 x 27.4 x 23.0mm
Weight	THT	60g typ.
	wired	65g typ.
continued on next page		

Specifications (measured @ Ta= 25°C, nom. Vin, full load and after warm-up unless otherwise stated)

Dimension Drawing (mm)

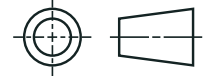
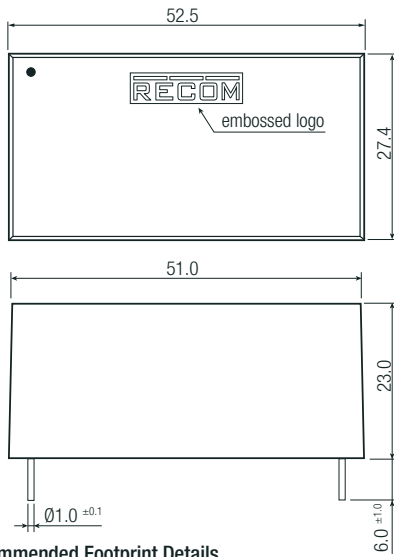

Pinning information

Pin #	Single	Dual
1	VAC in (N)	VAC in (N)
2	VAC in (L)	VAC in (L)
3	no pin	-Vout
4	-Vout	Com
5	+Vout	+Vout

Tolerance: xx.x= ±0.5mm
xx.xx= ±0.25mm

Recommended Footprint Details

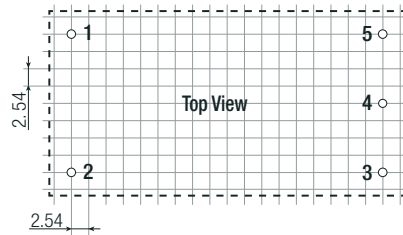
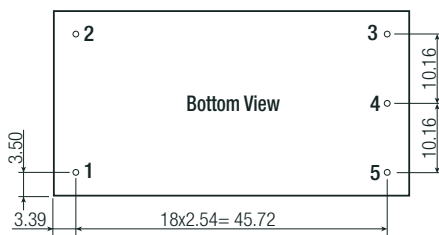

Dimension Drawing Single Wired (mm)

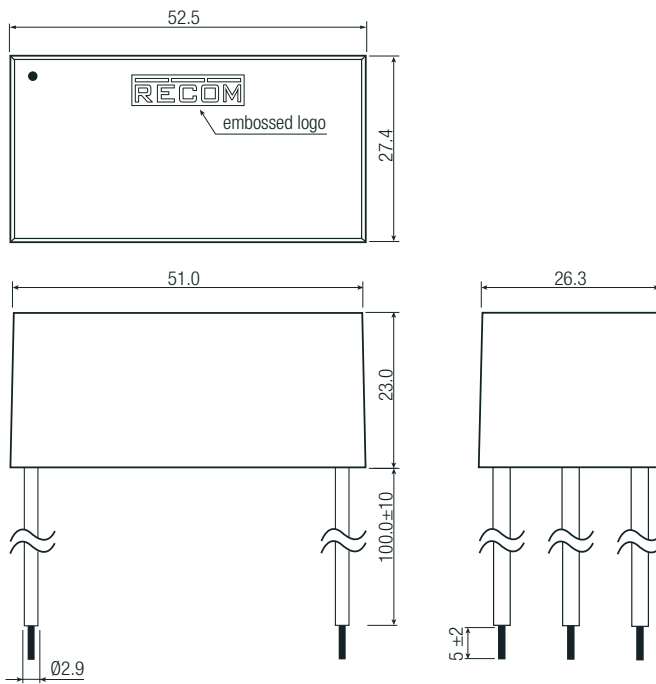

Wired information

#	Function	Wire color	Type	AWG
1	VAC in (N)	blue	UL-1015	18
2	VAC in (L)	brown	UL-1015	18
4	-Vout	black	UL-1015	18
5	+Vout	red	UL-1015	18

Tolerance: xx.x= ±0.5mm
xx.xx= ±0.25mm

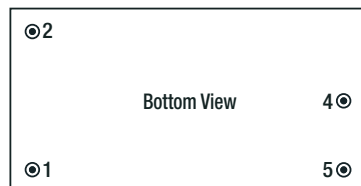

Specifications (measured @ Ta= 25°C, nom. Vin, full load and after warm-up unless otherwise stated)

PACKAGING INFORMATION			
Parameter	Type		Value
Packaging Dimension (LxWxH)	pin wired	tube tray	490.0 x 56.0 x 40.0mm
			488.0 x 202.0 x 47.0mm
Packaging Quantity	tube		15pcs
	tray		20pcs
Storage Temperature Range			-40°C to +85°C
Storage Humidity	non-condensing		20% to 90% RH max.

The product information and specifications may be subject to changes even without prior written notice. The product has been designed for various applications; its suitability lies in the responsibility of each customer. The products are not authorized for use in safety-critical applications without RECOM's explicit written consent. A safety-critical application is an application where a failure may reasonably be expected to endanger or cause loss of life, inflict bodily harm or damage property. The applicant shall indemnify and hold harmless RECOM, its affiliated companies and its representatives against any damage claims in connection with the unauthorized use of RECOM products in such safety-critical applications.