

PoE PSE Controller

Introduction

The Microchip Generation 6 family of PSE controllers include the PD69210 and PD69220 devices. The PD69210 and PD69220 controllers have an identical feature set and differ only in physical pinout. They are based on the Microchip SAM D21 family. The PD69210 or PD69220 controllers are recommended for all new designs.

The PD69210 or PD69220 controllers when paired with the Microchip PD69208T4, PD69204T4, or PD69208M managers are part of a Power over Ethernet Power Supplying Equipment (PSE) system. This system enables designers to integrate enhanced mode PoE capabilities, as specified in IEEE[®] 802.3af, IEEE 802.3at, IEEE 802.3bt, and PoH standards, into an Ethernet switch. They support up to 48 4-pair or 2-pair logical ports.

Both controllers are available in a 32-pin, 5 mm × 5 mm QFN package.

Typical PoE Application

The following figure shows the typical PoE application of Microchip Generation 6 devices.

Figure 1. Typical PoE Application

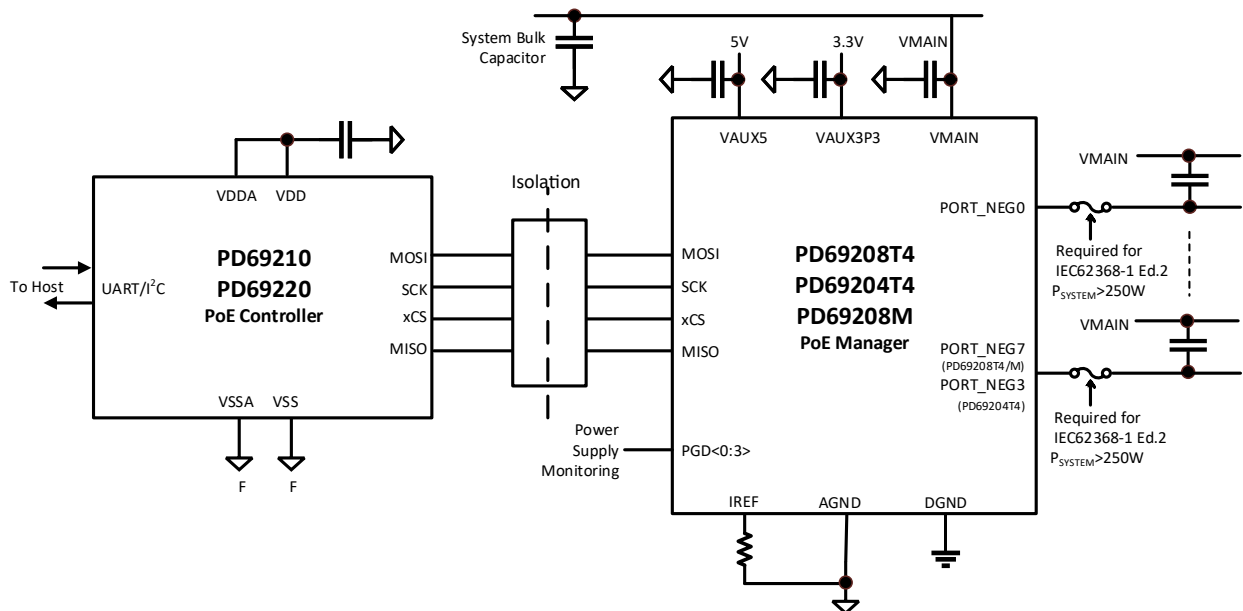

For more information, consult Microchip [AN3361 Designing an IEEE 802.3af/802.3at/802.3bt-Compliant PD69208 48-Port PoE System](#).

Features Matrix

Table 1. Features Matrix

Feature	Description	PD69210	PD69220
Support IEEE [®] 802.3af/at	—	Y	Y
Support IEEE 802.3bt	—	Y	Y
Support HDBaseT (PoH)	—	Y	Y
Port control matrix	Port matrix control enables to ascribe each physical port in the system to a logical port.	2p/4p	2p/4p
Logical ports	A logical port can be built from 2× physical ports or 1× physical port.	48	48
Maximum 2-pair power	—	45W	45W
Power management	The system supports three power management modes: Class (LLDP), Dynamic, and Static.	Per port	Per port
Power good	Used to select the system power bank to be applied to the specific PoE manager.	Y	Y
Port power limit	Configurable port power limit; when a port exceeds the limit, it is automatically disconnected.	Y	Y
Interrupt pin	Interrupt out from PoE controller indicating events, such as port on, port off, port fault, PoE device fault, voltage out of range, and more.	Y	Y
Disable port pin	Shuts down all of the PoE ports in the system.	Y	Y
System OK indication	System validity indication. Provides a digital output signal to the host or to control an LED to indicate system status. When the system is OK pin state is low.	Y	Y
Legacy (reduced capacitance) detection	Enables detection and powering of Pre-standard Devices (PDs).	Per port	Per port
LED stream	A direct SPI interface to an external LED stream.	Y	Y
Fast PoE	Ability of a system to quickly boot and power up ports without waiting for the host setting.	Y	Y
Perpetual PoE	Ability of a PoE system to maintain PoE power while upgrading host firmware or host is in reset.	Y	Y
Communication	Communication interface with host.	I ² C or UART	I ² C or UART
Communications protocol	Compatible with previous generations controllers.	Y	Y
Pin-compatible with PD69200	Able to use on a PCB that was designed for the PD69200.	N	Y
RoHS	—	Y	Y
MSL	—	1	3

Table of Contents

Introduction.....	1
Typical PoE Application.....	1
Features Matrix.....	2
1. Architecture.....	4
1.1. Firmware.....	4
1.2. Communication.....	4
1.3. GUI.....	5
1.4. Software Library.....	5
1.5. SPI Communication.....	5
1.6. UART	5
1.7. I ² C	5
1.8. UART or I ² C Address Selection.....	6
2. Electrical Specifications.....	7
2.1. Electrical Characteristics.....	7
2.2. Immunity.....	7
2.3. Absolute Maximum Ratings.....	7
3. Pins.....	8
3.1. Pin Diagrams.....	8
3.2. Pin Descriptions.....	8
4. Package Information.....	11
4.1. PD69210 Package Outline Drawing.....	11
4.2. PD69220 Package Outline Drawing.....	12
4.3. Thermal Specifications.....	13
4.4. Recommended PCB Layout – PD69210.....	14
4.5. Recommended PCB Layout – PD69220 New Design.....	15
4.6. Recommended PCB Layout – PD69220 Based on PD69200 Footprint	16
4.7. Recommended Solder Reflow Information.....	18
5. Ordering Information.....	20
6. Reference Documents.....	21
7. Revision History.....	22
Microchip Information.....	23
The Microchip Website.....	23
Product Change Notification Service.....	23
Customer Support.....	23
Microchip Devices Code Protection Feature.....	23
Legal Notice.....	23
Trademarks.....	24
Quality Management System.....	25
Worldwide Sales and Service.....	26

1. Architecture

The following figure shows the simplified hardware architecture and firmware architecture of the PoE system based on the PD69210 and PD69220 controllers and PD69208T4, PD69204T4, and PD69208M managers.

Figure 1-1. Simplified Hardware Architecture

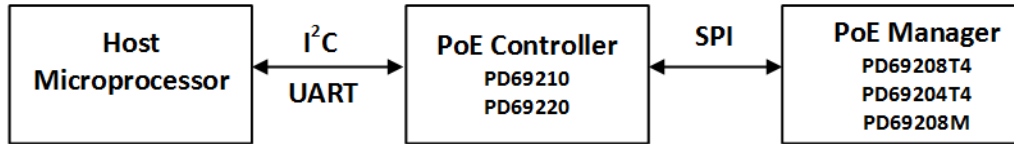
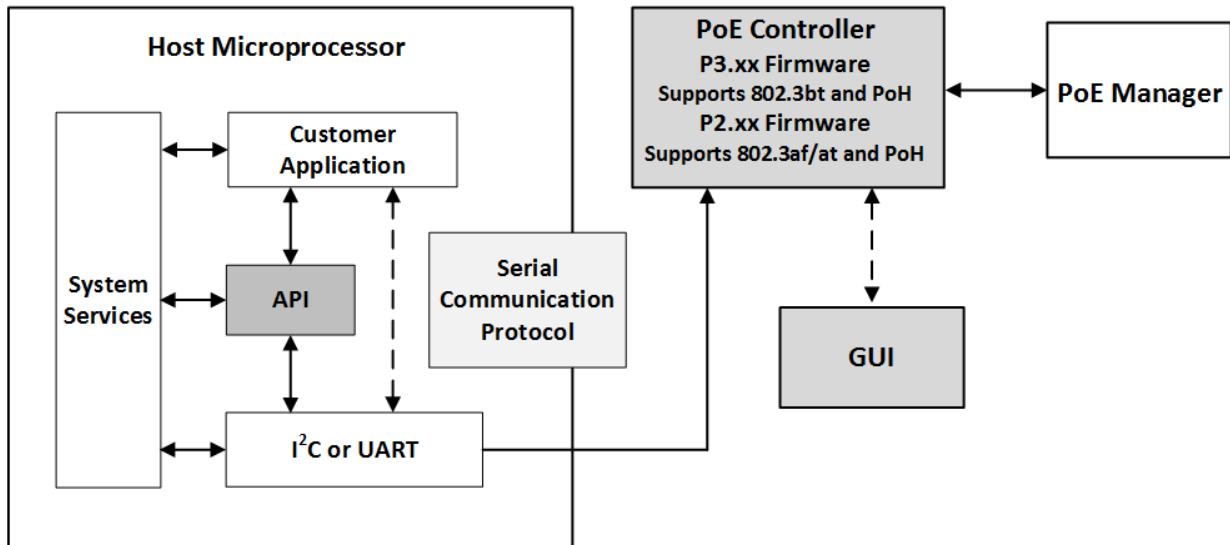

Figure 1-2. Simplified Firmware Architecture



Notes:

- Dark grey boxes indicate Microchip-supplied firmware.
- Light grey boxes indicate Microchip-provided documentation.
- White boxes are user-supplied.

1.1 Firmware

Following are the key firmware features of the PD69210 and PD69220 controllers:

- The firmware is pre-programmed in PD69210 and PD69220. Firmware version is identifiable through the IC Ordering Part Number.
- The firmware is vendor-agnostic with regards to choice of the host controller.
- The firmware can be operated standalone or with I²C or UART communication to host.
- Default profiles are coded into the firmware. Microchip offers a Configuration Tool for profile modification.
- The firmware is field-upgradeable through the I²C or UART link.

1.2 Communication

Communication between the host application and the controller's firmware may be done through a 15-byte protocol. Customers may use a Microchip-provided API. Microchip provides a Serial Communication Protocol Guide.

1.3 GUI

This is a diagnostic tool for control of the Microchip PSE emulating or bypassing the host processor.

1.4 Software Library

Firmware (without the boot section), GUI, and API are available on [Microchip's Software Library](#).

1.5 SPI Communication

PD69208T4, PD69204T4, and PD69208M managers use SPI communication in SPI client mode to communicate with the various controllers. Each manager has an address determined by ADDR0–ADDR3 pins. Each controller can support up to 12 ICs at addresses 0–11. The actual frequency between PD692x0 ICs is 1 MHz.

The following table lists the SPI communication packet structure.

Table 1-1. SPI Communication—Packet Structure

Control Byte Selects PD69208T4 According to Address	R/W Bit	Internal Register Address	Number of Words (Read Access Only)	Data Written to IC (Write Access Only) Read from IC (Read Access Only)
8 bits	R(0)/W(1)	8 bits	8 bits	16 bits

For more information about the SPI interface, see the *PD69208T4, PD69204T4, and PD69208M Manager Data Sheet*.

1.6 UART

A pull-up resistor is required on the UART communication line. For more information, see [AN3361 Designing an IEEE 802.3af/at/bt PoE System Based on PD692x0/PD69208](#).

Following is the UART communications configuration:

- Bits per second: 19,200 bps
- Data bits: 8
- Parity: None Stop bits: 1
- Flow control: None

1.7 I²C

The PD692x0 requires the host to support I²C clock stretch. Following is the I²C communication configuration:

- Address: 7 bits
- Clock stretch: Host must support
- Transaction: 15 bytes or 1 byte

1.8 UART or I²C Address Selection

The choice of UART or I²C interface between the host CPU is made by applying a specific voltage level to pin #13 (I2C_ADDR_MEAS) on the PD69210, or by applying a specific voltage level to pin #22 (I2C_ADDR_MEAS) on the PD69220. Additionally, the specific I²C address is also set by this voltage level. In all cases, the voltage is set through an external resistor divider, as shown in the following figure.

Figure 1-3. I²C Address Selection

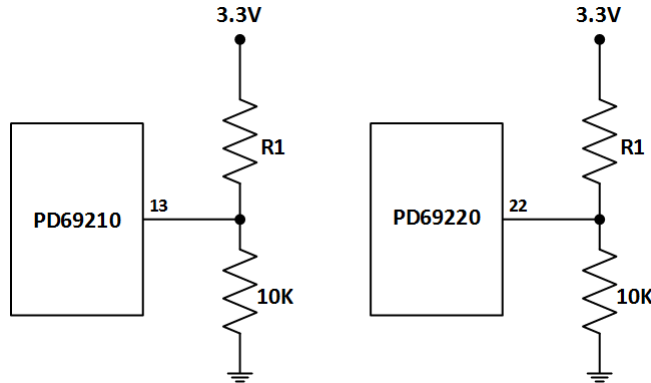

The following table lists the specific value of R to choose UART or I²C and set the address.

Table 1-2. I²C Address Selection

I2C Address (Hexadecimal)	R1–KΩ (1%)
UART	N.C.
0x4	147
0x8	86.6
0xC	57.6
0x10	43.2
0x14	34
0x18	26.7
0x1C	22.1
0x20	18.2
0x24	15.4
0x28	13
0x2C	11
0x30	9.31
0x34	7.87
0x38	6.49
0x3C	5.49

2. Electrical Specifications

The following sections describe the electrical specifications for the PD69210 and PD69220 devices.

2.1 Electrical Characteristics

For a complete list of electrical characteristics, see *Microchip SAM21 Family Datasheet*.

Table 2-1. General Operating Conditions

Symbol	Parameter	Min.	Typ.	Max.	Units
V _{DD}	Power supply voltage	3.0	3.3	3.63	V
V _{DDA}	Power supply voltage	3.0	3.3	3.63	V
T _A	Temperature range	-40	25	85	°C
T _J	Junction temperature	—	—	100	°C

2.2 Immunity

Table 2-2. Immunity

Symbol	Parameter	Conditions	Min.	Max.	Units
ESD	ESD rating	HBM ¹	-2000	2000	V
		CDM ²	-500	500	V

Notes:

- ESD HBM complies with JESD22 Class 2 standard.
- ESD CDM complies with JESD22 Class 1 standard.

2.3 Absolute Maximum Ratings

Stresses beyond those listed in this section may cause permanent damage to the device. This is a stress rating only and functional operation of the device at these or other conditions beyond those indicated in the operational sections of this specification is not implied. Exposure to absolute maximum rating conditions for extended periods may affect device reliability.

Table 2-3. Absolute Maximum Ratings

Symbol	Parameter	Min.	Max.	Units
V _{DD}	Power supply voltage	0	3.8	V
V _{PIN}	Pin voltage with respect to GND and VDD	GND - 0.6V	VDD + 0.6V	V
	Lead soldering temperature (40s, reflow)	—	260	°C
	Storage temperature	-60	150	°C

3. Pins

This section describes 32 pins of PD69210 and PD69220 controllers.

3.1 Pin Diagrams

The following figure shows the top view of PD69210 and PD69220 devices.

Figure 3-1. PD69210 and PD69220 Pin Diagram

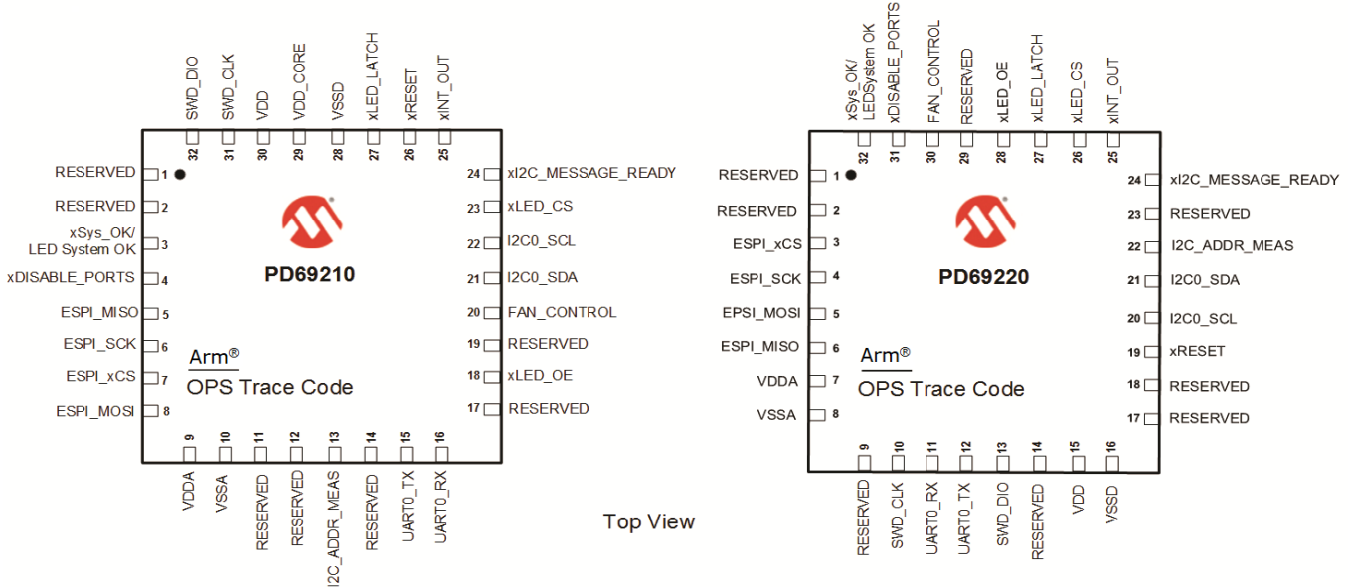

Top View

Note: For definitions about markings in the pinout diagram, see [Table 5-1](#).

3.2 Pin Descriptions

The following table lists the functional pin descriptions of the PD69210 and PD69220 devices.

Table 3-1. Pin Descriptions

PD69210 Pin	PD69220 Pin	Designation	Type	Description
1	1	Reserved	OUT	Reserved UART. Leave open.
2	2	Reserved	IN	Reserved UART. Pull up to 3.3V via 10 kΩ.
3	32	xSys_OK/LED System OK	OUT	System validity indication. The behavior of this output is controlled by individual software mask. (Active Low)
4	31	xDISABLE_PORTS	IN	Disable all PoE ports. When this input is asserted low, the controller shuts down all PoE ports in the system. See AN3361 Designing an IEEE 802.3af/at/bt PoE System Based on PD692x0/PD69208 application note for pin connection requirements. (Active Low)

.....continued

PD69210 Pin	PD69220 Pin	Designation	Type	Description
5	6	ESPI_MISO	IN	ESPI bus to PoE manager. SPI host in, client out. SPI packets are received on this line.
6	4	ESPI_SCK	OUT	ESPI bus to PoE manager. SPI clock output to PD6920x, and LED stream clock output, set to 1 MHz.
7	3	ESPI_xCS	OUT	ESPI bus to PoE manager. SPI chip select. Pull-up required. See AN3361 Designing an IEEE 802.3af/at/bt PoE System Based on PD692x0/PD69208 application note for pin connection requirements. (Active Low)
8	5	ESPI_MOSI	OUT	ESPI bus from PoE manager. SPI host out, client in. SPI packets are received on this line.
9	7	VDDA	Supply	Main Supply 3.3V.
10	8	VSSA	GND	Ground.
11	14	Reserved	Analog_IN	Reserved Analog_IN. Connect to 3.3V or GND through 10 kΩ.
—	9, 29	Reserved	Analog_IN	Reserved Analog_IN. Connect to 3.3V.
12, 19	—	Reserved	—	Reserved. Leave open.
13	22	I2C_ADDR_MEAS	Analog_IN	Analog input to determine I ² C address or UART operation.
14	23	Reserved	—	Connect to GND.
15	12	UART0_TX	OUT	UART transmit to host. 15-byte protocol reply/telemetry is transmitted on this line. The baud rate is set to 19,200 bps.
16	11	UART0_RX	IN	UART receive from a host. 15-byte protocol commands are received on this line. The baud rate is set to 19,200 bps. Pull-up is required. See AN3361 Designing an IEEE 802.3af/at/bt PoE System Based on PD692x0/PD69208 application note for details.
17	18	Reserved	Oscillator	Reserved. Oscillator output. Leave open.
	17	Reserved	Oscillator	Reserved. Oscillator output. Leave open.
18	28	xLED_OE	OUT	Output enable signal for the LED stream. (Active Low)
20	30	FAN_CONTROL	OUT	Logic out that may be used to control a fan driver. (Active High)
21	21	I2C0_SDA	IN/OUT	I ² C bidirectional data. 15-byte protocol messages are transmitted on this line. Pull-up required, see AN3361 Designing an IEEE 802.3af/at/bt PoE System Based on PD692x0/PD69208 application note for details.

.....continued

PD69210 Pin	PD69220 Pin	Designation	Type	Description
22	20	I2C0_SCL	IN/OUT	I ² C clock from the host. Speed is limited to 400 KHz. Clock stretch required. Pull-up required, see AN3361 Designing an IEEE 802.3af/at/bt PoE System Based on PD692x0/PD69208 application note for details.
23	26	xLED_CS	OUT	Chip select signal for LED stream. (Active Low)
24	24	xI2C_MESSAGE_READY	OUT	I ² C message ready for reading by the host. Controller asserts this line low when it has an answer to the host. Therefore, the host can poll this line and initiate I ² C read cycle only when the message is ready. After the host reads the data from the controller, this pin is asserted to high. (Active Low)
25	25	xINT_OUT	OUT	Interrupt output indication. This line is asserted low when a pre-configured event is in progress. (Active Low)
26	19	xRESET	IN/OUT	Host Reset input (Active Low). Controller can generate self-reset. In this case, the xRESET pin is driven low by the controller for 100 μ s. See AN3361 Designing an IEEE 802.3af/at/bt PoE System Based on PD692x0/PD69208 for pin connection requirements.
27	27	xLED_LATCH ²	OUT	Latch signal for LED stream. (Active Low)
28	16	VSSD	GND	Ground.
29	-	VDD_CORE	Power	1.2V core voltage connect 1 μ F capacitor to VSSD.
30	15	VDD	Supply	Main 3.3V supply.
31	10	SWD_CLK	—	PD69210 use a 1 k Ω pull-up to 3.3V. PD69220 leave open or use 1k pull-up.
32	13	SWD_DIO	—	Leave open.
ePAD	ePAD	ePAD	—	Connect to VSSA. Must have sufficient copper mass to ensure adequate thermal performance.

4. Package Information

This section provides the package information for the PD69210 and PD69220 devices.

4.1 PD69210 Package Outline Drawing

The following figure shows the package drawing of PD69210 device.

Figure 4-1. PD69210 Package Outline Drawing (32 Pin QFN 5 mm × 5 mm)

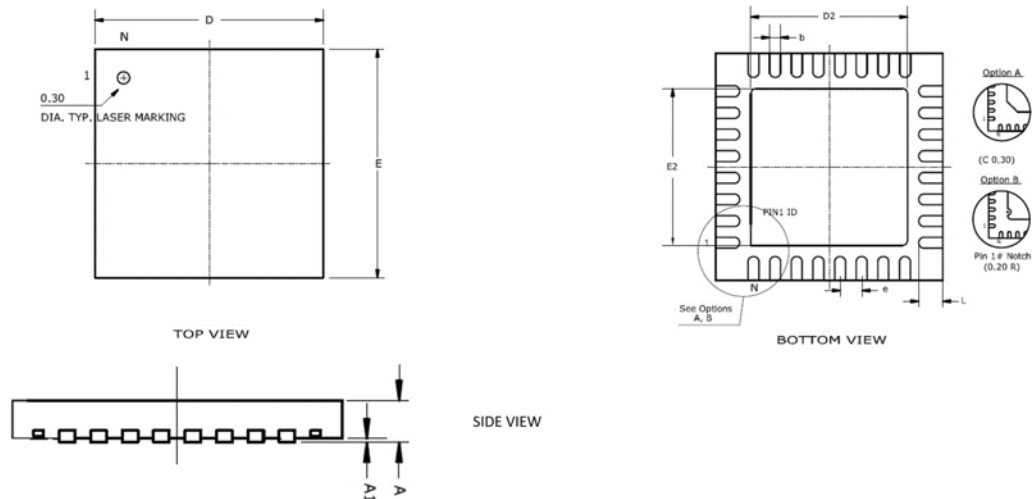

The following table lists the dimensions and measurements of the PD69210 package.

Table 4-1. PD69210 Package Outline Dimensions and Measurements

Dimension	Millimeters		Inches	
	Min.	Max.	Min.	Max.
A	0.80	1.00	0.031	0.039
A1	0.00	0.05	0	0.002
e	0.50 BSC	—	0.02 BSC	—
L	0.30	0.50	0.012	0.02
b	0.18	0.30	0.007	0.012
D2	3.50	3.70	0.138	0.147
E2	3.50	3.70	0.138	0.147
D	5.00 BSC	—	0.197 BSC	—
E	5.00 BSC	—	0.197 BSC	—

Note: Dimensions do not include protrusions; they must not exceed 0.155 mm (0.006 inch) on any side. Lead dimension must not include solder coverage. Dimensions are in millimeters and inches for reference.

4.2 PD69220 Package Outline Drawing

The following figure shows the package outline drawing of the PD69220 device.

Figure 4-2. PD69220 Package Outline Drawing (32-Pin LGA 5 mm × 5 mm)

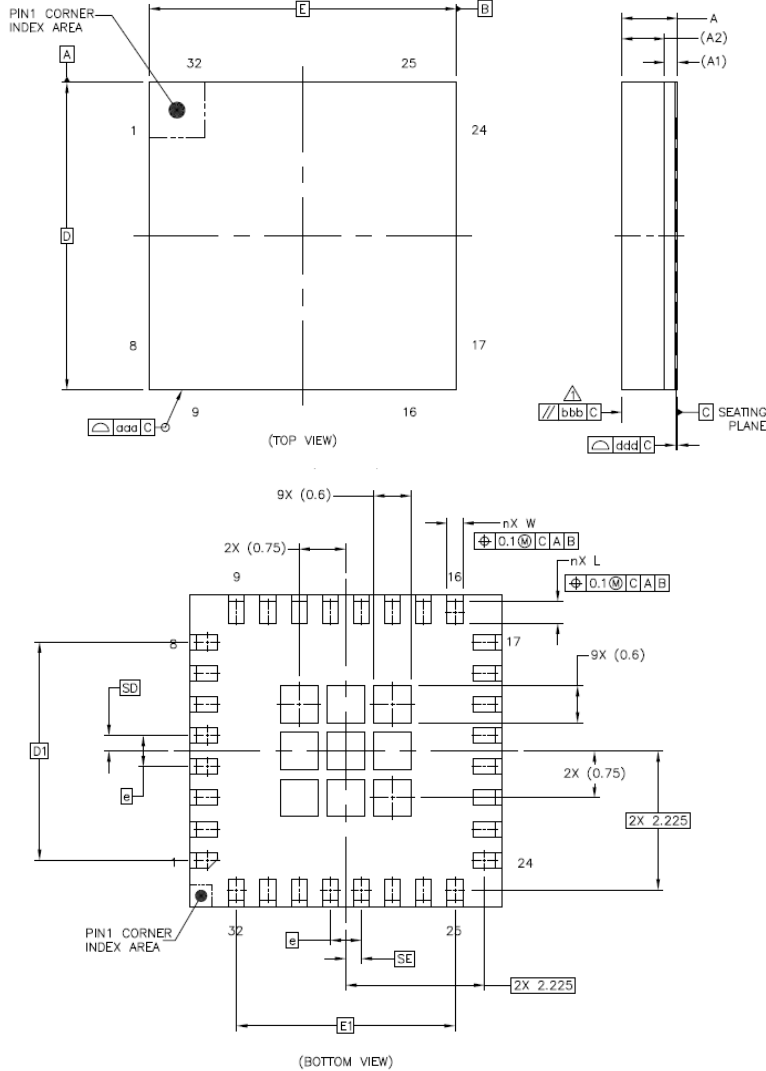

The following table lists the dimensions and measurements of the PD69220 package.

Table 4-2. PD69220 Package Outline Dimensions and Measurements

Dimension	Millimeters		
	Min.	Typ.	Max.
A	—	—	1
A1	—	0.21	—
A2	—	0.7	—
D	—	5	—
E	—	5	—

.....continued			
Dimension	Millimeters		
	Min.	Typ.	Max.
W	0.2	0.25	0.3
L	0.30	0.35	0.4
e	—	0.5	—
n	—	32	—
D1	—	3.5	—
E1	—	3.5	—
SD	—	0.25	—
SE	—	0.25	—

4.3 Thermal Specifications

The following table lists the thermal specifications of the PD69210 and PD69220.

Table 4-3. Thermal Specifications

Thermal Resistance	Device	Typ.	Units	Description
θ_{JA}	PD69210	40.9	°C/W	Junction-to-ambient thermal resistance.
θ_{JC}	PD69210	15.2	°C/W	Junction-to-case thermal resistance.
θ_{JA}	PD69220	65.0	°C/W	Junction-to-ambient thermal resistance.
θ_{JC}	PD69220	21.5	°C/W	Junction-to-case thermal resistance.

4.4 Recommended PCB Layout – PD69210

The following figures show the recommended PCB layout pattern for the 32-pin QFN 5 mm × 5 mm PD69210. Units are in mm.

Figure 4-3. PD69210 Solder Mask

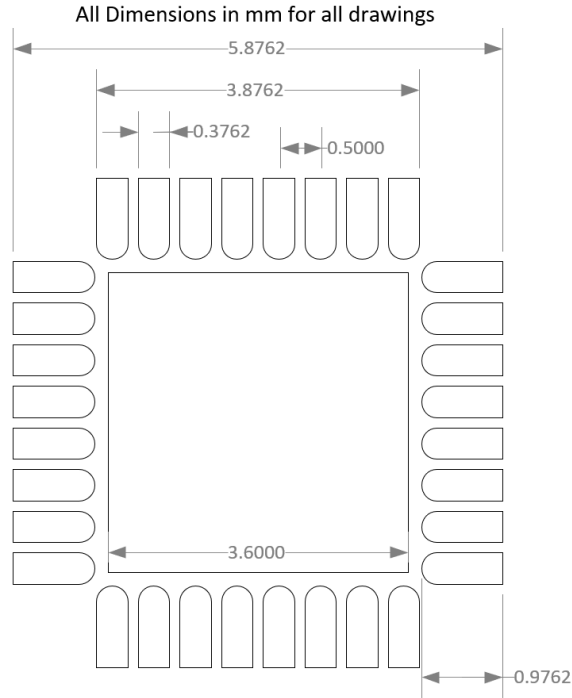

Figure 4-4. PD69210 Top-Layer Copper

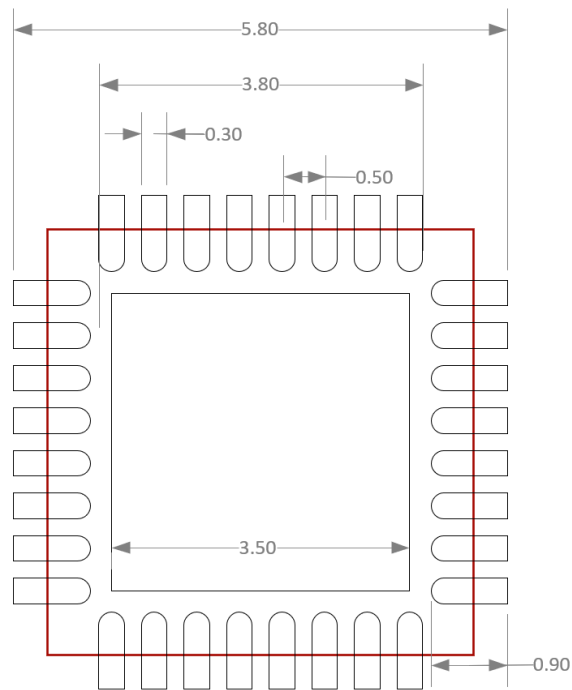
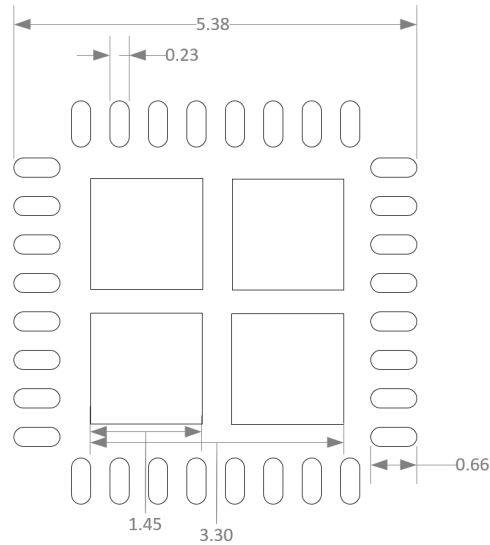

Figure 4-5. PD69210 Paste Mask



Note: The contract manufacturer has latitude to modify the solder paste stencil for manufacturability reasons. The solder paste stencil covers 65% to 80% of the thermal pad. Any design must be subject to system validation and qualification prior to commitment to mass production of field deployment. Use a 5 mil stencil.

4.5 Recommended PCB Layout – PD69220 New Design

The following figures show the recommended PCB layout pattern for the 32-pin LGA 5 mm × 5 mm PD69220 when the PD69220 is used from a new PCB layout or “Start from Scratch” PCB layout. Units are in mm.

Figure 4-6. PD69220 New Design Solder Mask

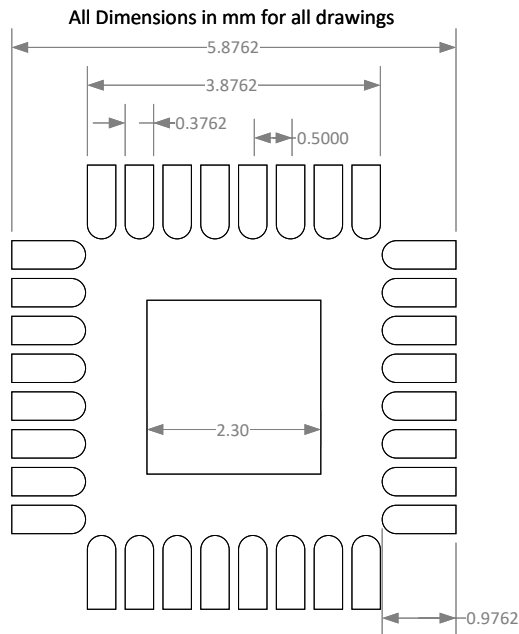

Figure 4-7. PD69220 New Design Top Layer Copper

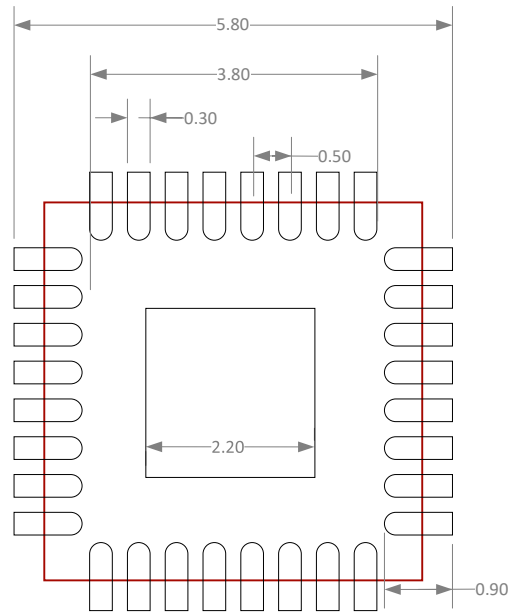
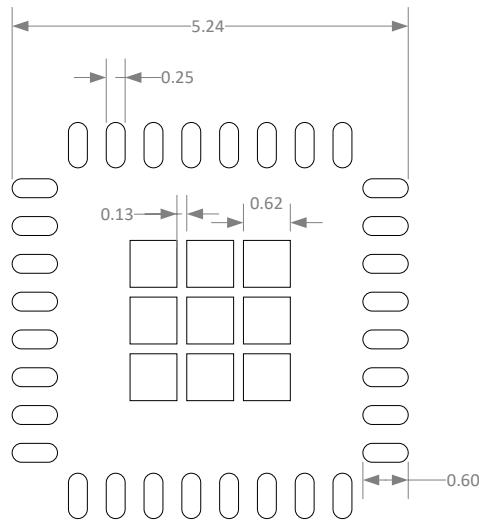

Figure 4-8. PD69220 New Design Paste Mask

It is critical that this paste mask design be
EXACTLY followed



Note:

The contract manufacturer has latitude to modify the solder paste stencil for manufacturability reasons. The solder paste stencil covers 65% to 80% of the thermal pad. Any design must be subject to system validation and qualification prior to commitment to mass production of field deployment. Use a 5 mil stencil.

4.6 Recommended PCB Layout – PD69220 Based on PD69200 Footprint

The following figures show the recommended PCB layout pattern for the 32-pin LGA 5 mm × 5 mm PD69220 when the PD69220 is used on an existing PCB that was designed to accept the PD69200 controller. Units are in mm.

Figure 4-9. PD69220 Solder Mask Based on PD69200

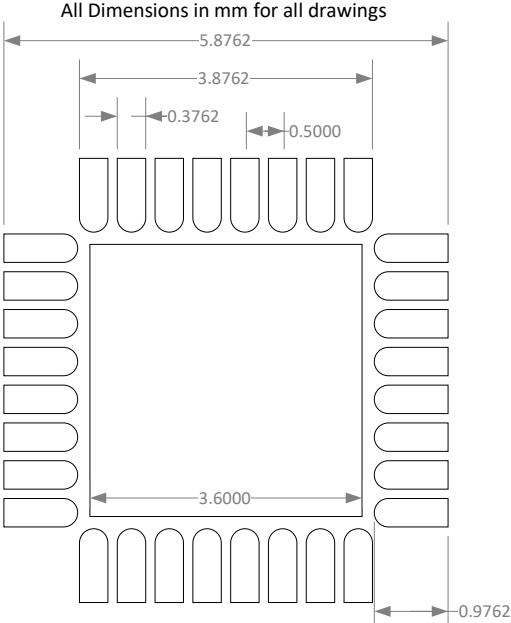

Figure 4-10. PD69220 Top Layer Copper Based on PD69200

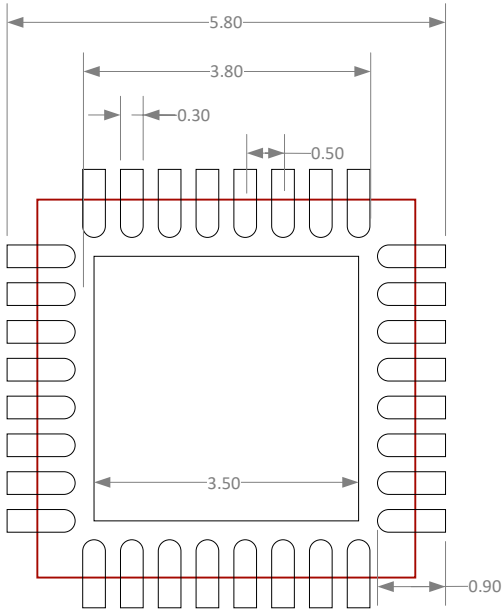
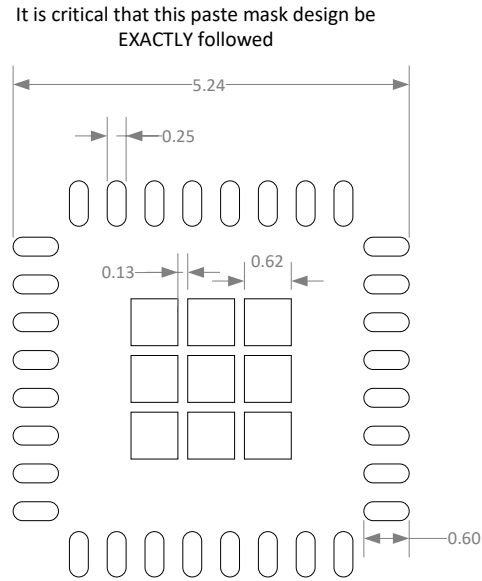

Figure 4-11. PD69220 Paste Mask



Note:

It is critical that this paste mask design be exactly followed. Use a 5 mil stencil.

4.7 Recommended Solder Reflow Information

- RoHS 6/6
- Pb-free 100% Matte Tin Finish
- Package Peak Temperature for Solder Reflow (40s maximum exposure)—260 °C (0 °C, -5 °C)

Table 4-4. Classification Reflow Profiles

Profile Feature	Sn-Pb Eutectic Assembly	Pb-Free Assembly
Average ramp-up rate (TS _{max} to Tp)	3 °C/s maximum	3 °C/s maximum
Preheat		
Temperature min (TS _{min})	100 °C	150 °C
Temperature max (TS _{max})	150 °C	200 °C
Time (ts _{min} to ts _{max})	60s to 120s	60s to 180s
Time Maintained		
Temperature (T _L)	183 °C	217 °C
Time (t _L)	60s to 150s	60s to 150s
Peak classification temperature (TP)	210 °C to 235 °C	240 °C to 255 °C
Time within 5 °C of actual peak temperature (tp)	10s to 30s	20s to 40s
Ramp-down rate	6 °C/s maximum	6 °C/s maximum
Time 25 °C to peak temperature	6 minutes maximum	8 minutes maximum

Figure 4-12. Classification Reflow Profiles

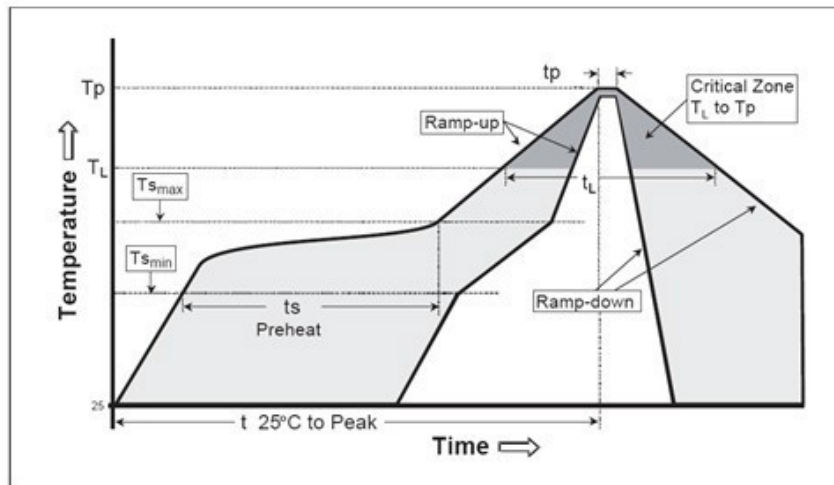

Table 4-5. Pb-Free Process—Package Classification Reflow Temperatures

Package Thickness	Volume < 350 mm ³	Volume 350–2000 mm ³	Volume > 2000 mm ³
Less than 1.6 mm ¹	260 + 0 °C	260 + 0 °C	260 + 0 °C
1.6 mm to 2.5 mm ¹	260 + 0 °C	250 + 0 °C	245 + 0 °C
Greater than or equal to 2.5 mm ¹	250 + 0 °C	245 + 0 °C	245 + 0 °C

Note:

1. Tolerance: The device manufacturer or supplier must assure process compatibility up to and including the stated classification temperature, that is, the Peak reflow temperature is +0 °C. For example, 260 °C to 0 °C, at the rated MSL value.

Exceeding the ratings that are mentioned in the preceding table might cause damage to the device.

5. Ordering Information

The following table lists the part ordering information for PD69210 and PD69220 devices.

Table 5-1. Ordering Information

Part Number	Package	Packaging Type	Temperature	Part Marking	Tray Marking
PD69210D ¹ VVVV ² SS ³	Plastic QFN 5 mm × 5 mm (32 lead)	Tray	–40 °C to 85 °C	Microchip Logo PD69210 ARM Logo YY ⁴ WW ⁵ NNN ⁶	PD69210D- VVVSS PD-OOOOGabb ⁷ YYWW
PD69210D ¹ VVVV ² SS ³ -TR	Plastic QFN 5 mm × 5 mm (32 lead)	Tape and reel	–40 °C to 85 °C	Microchip Logo PD69210 ARM Logo YY ⁴ WW ⁵ NNN ⁶	—
PD69220D ¹ VVVV ² SS ³	Plastic QFN Laminated ⁸ 5 mm × 5 mm (32 lead)	Tray	–40 °C to 85 °C	Microchip Logo PD69220 ARM Logo YY ⁴ WW ⁵ NNN ⁶	PD69220D- VVVSS PD-OOOOGabb ⁷ YYWW
PD69220D ¹ VVVV ² SS ³ -TR	Plastic QFN Laminated ⁸ 5 mm × 5 mm (32 lead)	Tape and reel	–40 °C to 85 °C	Microchip Logo PD69220 ARM Logo YY ⁴ WW ⁵ NNN ⁶	—

1. D is detection method.
 - C = IEEE 802.3 and pre-standard
 - R = IEEE 802.3 only
2. VVVV is firmware revision.
3. SS is firmware parameters options.
4. Year code (last two digits of calendar year).
5. Week code (week of January 1 is week 01).
6. Alphanumeric trace code.
7. Operational part number.
8. Laminated QFN is also called a Land Grid Array (LGA).

The firmware release note has all required information about how to specify the choice of VVVV and SS. Find the *Firmware Release Notes* in the [Microchip Software Libraries](#), and register to My Microchip account to access the release notes.

Notes:

- The package meets RoHS, Pb-free of the European Council to minimize the environmental impact of electrical equipment.
- Initial burning of controller's firmware is performed in the factory. Firmware upgrades can be performed by users using the communication interface. For more information, see TN-140 (Catalog Number: 06-0024-081).

6. Reference Documents

- IEEE Std 802.3-2018 Clause 33 Power over Ethernet over 2-Pair and Clause 145 Power over Ethernet
- PD69210 Communication Protocol User Guide
- AN3361 Designing an IEEE 802.3af/at/bt PoE System Based on PD692x0/PD69208
- PD69208T4, PD69204T4, and PD69208M PoE PSE Manager Datasheet
- PD69200 PoE PSE Controller Datasheet

7. Revision History

Revision	Date	Description
D	08/2022	<ul style="list-style-type: none"> Edited section Recommended PCB Layout – PD69210. Added sections Recommended PCB Layout – PD69220 New Design and Recommended PCB Layout – PD69220 Based on PD69200 Footprint.
C	05/2022	<p>The following is the summary of changes made in this revision:</p> <ul style="list-style-type: none"> Added MSL value to Table 1. Edited the Pin-compatible with PD69200 feature in Table 1. Removed note to Figure 4-4.
B	01/2021	<ul style="list-style-type: none"> Updated Figure 1. Updated all figures in section Recommended PCB Layout.
A	03/2020	<p>This is the initial issue of this document. The PD69220 PoE PSE controller is a new product offering and has not been previously described in any other document. The PD69210 PoE PSE controller was previously described in the following documents:</p> <ul style="list-style-type: none"> PD69208T4 and PD69210 Datasheet (Revision 3 September 2019 Document Number PD-000357193) PD69204T4 and PD69210 Datasheet (Revision 3 September 2019 Document Number PD-000359832) PD69208M and PD69210 Datasheet (Revision 3 September 2019 Document Number PD-000359833)

Microchip Information

The Microchip Website

Microchip provides online support via our website at www.microchip.com/. This website is used to make files and information easily available to customers. Some of the content available includes:

- **Product Support** – Data sheets and errata, application notes and sample programs, design resources, user's guides and hardware support documents, latest software releases and archived software
- **General Technical Support** – Frequently Asked Questions (FAQs), technical support requests, online discussion groups, Microchip design partner program member listing
- **Business of Microchip** – Product selector and ordering guides, latest Microchip press releases, listing of seminars and events, listings of Microchip sales offices, distributors and factory representatives

Product Change Notification Service

Microchip's product change notification service helps keep customers current on Microchip products. Subscribers will receive email notification whenever there are changes, updates, revisions or errata related to a specified product family or development tool of interest.

To register, go to www.microchip.com/pcn and follow the registration instructions.

Customer Support

Users of Microchip products can receive assistance through several channels:

- Distributor or Representative
- Local Sales Office
- Embedded Solutions Engineer (ESE)
- Technical Support

Customers should contact their distributor, representative or ESE for support. Local sales offices are also available to help customers. A listing of sales offices and locations is included in this document.

Technical support is available through the website at: www.microchip.com/support

Microchip Devices Code Protection Feature

Note the following details of the code protection feature on Microchip products:

- Microchip products meet the specifications contained in their particular Microchip Data Sheet.
- Microchip believes that its family of products is secure when used in the intended manner, within operating specifications, and under normal conditions.
- Microchip values and aggressively protects its intellectual property rights. Attempts to breach the code protection features of Microchip product is strictly prohibited and may violate the Digital Millennium Copyright Act.
- Neither Microchip nor any other semiconductor manufacturer can guarantee the security of its code. Code protection does not mean that we are guaranteeing the product is "unbreakable". Code protection is constantly evolving. Microchip is committed to continuously improving the code protection features of our products.

Legal Notice

This publication and the information herein may be used only with Microchip products, including to design, test, and integrate Microchip products with your application. Use of this information in any other manner violates these terms. Information regarding device applications is provided only for your convenience and may be superseded

by updates. It is your responsibility to ensure that your application meets with your specifications. Contact your local Microchip sales office for additional support or, obtain additional support at www.microchip.com/en-us/support/design-help/client-support-services.

THIS INFORMATION IS PROVIDED BY MICROCHIP "AS IS". MICROCHIP MAKES NO REPRESENTATIONS OR WARRANTIES OF ANY KIND WHETHER EXPRESS OR IMPLIED, WRITTEN OR ORAL, STATUTORY OR OTHERWISE, RELATED TO THE INFORMATION INCLUDING BUT NOT LIMITED TO ANY IMPLIED WARRANTIES OF NON-INFRINGEMENT, MERCHANTABILITY, AND FITNESS FOR A PARTICULAR PURPOSE, OR WARRANTIES RELATED TO ITS CONDITION, QUALITY, OR PERFORMANCE.

IN NO EVENT WILL MICROCHIP BE LIABLE FOR ANY INDIRECT, SPECIAL, PUNITIVE, INCIDENTAL, OR CONSEQUENTIAL LOSS, DAMAGE, COST, OR EXPENSE OF ANY KIND WHATSOEVER RELATED TO THE INFORMATION OR ITS USE, HOWEVER CAUSED, EVEN IF MICROCHIP HAS BEEN ADVISED OF THE POSSIBILITY OR THE DAMAGES ARE FORESEEABLE. TO THE FULLEST EXTENT ALLOWED BY LAW, MICROCHIP'S TOTAL LIABILITY ON ALL CLAIMS IN ANY WAY RELATED TO THE INFORMATION OR ITS USE WILL NOT EXCEED THE AMOUNT OF FEES, IF ANY, THAT YOU HAVE PAID DIRECTLY TO MICROCHIP FOR THE INFORMATION.

Use of Microchip devices in life support and/or safety applications is entirely at the buyer's risk, and the buyer agrees to defend, indemnify and hold harmless Microchip from any and all damages, claims, suits, or expenses resulting from such use. No licenses are conveyed, implicitly or otherwise, under any Microchip intellectual property rights unless otherwise stated.

Trademarks

The Microchip name and logo, the Microchip logo, Adaptec, AVR, AVR logo, AVR Freaks, BesTime, BitCloud, CryptoMemory, CryptoRF, dsPIC, flexPWR, HELDO, IGLOO, JukeBlox, KeeLoq, Kleer, LANCheck, LinkMD, maXStylus, maXTouch, MediaLB, megaAVR, Microsemi, Microsemi logo, MOST, MOST logo, MPLAB, OptoLyzer, PIC, picoPower, PICSTART, PIC32 logo, PolarFire, Prochip Designer, QTouch, SAM-BA, SenGenuity, SpyNIC, SST, SST Logo, SuperFlash, Symmetricom, SyncServer, Tachyon, TimeSource, tinyAVR, UNI/O, Vectron, and XMEGA are registered trademarks of Microchip Technology Incorporated in the U.S.A. and other countries.

AgileSwitch, APT, ClockWorks, The Embedded Control Solutions Company, EtherSynch, Flashtec, Hyper Speed Control, HyperLight Load, Libero, motorBench, mTouch, Powermite 3, Precision Edge, ProASIC, ProASIC Plus, ProASIC Plus logo, Quiet- Wire, SmartFusion, SyncWorld, Temux, TimeCesium, TimeHub, TimePictra, TimeProvider, TrueTime, and ZL are registered trademarks of Microchip Technology Incorporated in the U.S.A.

Adjacent Key Suppression, AKS, Analog-for-the-Digital Age, Any Capacitor, AnyIn, AnyOut, Augmented Switching, BlueSky, BodyCom, Clockstudio, CodeGuard, CryptoAuthentication, CryptoAutomotive, CryptoCompanion, CryptoController, dsPICDEM, dsPICDEM.net, Dynamic Average Matching, DAM, ECAN, Espresso T1S, EtherGREEN, GridTime, IdealBridge, In-Circuit Serial Programming, ICSP, INICnet, Intelligent Paralleling, IntellIMOS, Inter-Chip Connectivity, JitterBlocker, Knob-on-Display, KoD, maxCrypto, maxView, memBrain, Mindi, MiWi, MPASM, MPF, MPLAB Certified logo, MPLIB, MPLINK, MultiTRAK, NetDetach, Omniscient Code Generation, PICDEM, PICDEM.net, PICkit, PICtail, PowerSmart, PureSilicon, QMatrix, REAL ICE, Ripple Blocker, RTAX, RTG4, SAM-ICE, Serial Quad I/O, simpleMAP, SimpliPHY, SmartBuffer, SmartHLS, SMART-I.S., storClad, SQL, SuperSwitcher, SuperSwitcher II, Switchtec, SynchroPHY, Total Endurance, Trusted Time, TSHARC, USBCheck, VariSense, VectorBlox, VeriPHY, ViewSpan, WiperLock, XpressConnect, and ZENA are trademarks of Microchip Technology Incorporated in the U.S.A. and other countries.

SQTP is a service mark of Microchip Technology Incorporated in the U.S.A.

The Adaptec logo, Frequency on Demand, Silicon Storage Technology, and Symmcom are registered trademarks of Microchip Technology Inc. in other countries.

GestIC is a registered trademark of Microchip Technology Germany II GmbH & Co. KG, a subsidiary of Microchip Technology Inc., in other countries.

All other trademarks mentioned herein are property of their respective companies.

© 2022, Microchip Technology Incorporated and its subsidiaries. All Rights Reserved.

ISBN: 978-1-6683-1136-3

Quality Management System

For information regarding Microchip's Quality Management Systems, please visit www.microchip.com/quality.

Worldwide Sales and Service

AMERICAS	ASIA/PACIFIC	ASIA/PACIFIC	EUROPE
<p>Corporate Office 2355 West Chandler Blvd. Chandler, AZ 85224-6199 Tel: 480-792-7200 Tel: 480-792-7277 Technical Support: www.microchip.com/support Web Address: www.microchip.com</p> <p>Atlanta Duluth, GA Tel: 678-957-9614 Fax: 678-957-1455</p> <p>Austin, TX Tel: 512-257-3370</p> <p>Boston Westborough, MA Tel: 774-760-0087 Fax: 774-760-0088</p> <p>Chicago Itasca, IL Tel: 630-285-0071 Fax: 630-285-0075</p> <p>Dallas Addison, TX Tel: 972-818-7423 Fax: 972-818-2924</p> <p>Detroit Novi, MI Tel: 248-848-4000</p> <p>Houston, TX Tel: 281-894-5983</p> <p>Indianapolis Noblesville, IN Tel: 317-773-8323 Fax: 317-773-5453 Tel: 317-536-2380</p> <p>Los Angeles Mission Viejo, CA Tel: 949-462-9523 Fax: 949-462-9608 Tel: 951-273-7800</p> <p>Raleigh, NC Tel: 919-844-7510</p> <p>New York, NY Tel: 631-435-6000</p> <p>San Jose, CA Tel: 408-735-9110 Tel: 408-436-4270</p> <p>Canada - Toronto Tel: 905-695-1980 Fax: 905-695-2078</p>	<p>Australia - Sydney Tel: 61-2-9868-6733</p> <p>China - Beijing Tel: 86-10-8569-7000</p> <p>China - Chengdu Tel: 86-28-8665-5511</p> <p>China - Chongqing Tel: 86-23-8980-9588</p> <p>China - Dongguan Tel: 86-769-8702-9880</p> <p>China - Guangzhou Tel: 86-20-8755-8029</p> <p>China - Hangzhou Tel: 86-571-8792-8115</p> <p>China - Hong Kong SAR Tel: 852-2943-5100</p> <p>China - Nanjing Tel: 86-25-8473-2460</p> <p>China - Qingdao Tel: 86-532-8502-7355</p> <p>China - Shanghai Tel: 86-21-3326-8000</p> <p>China - Shenyang Tel: 86-24-2334-2829</p> <p>China - Shenzhen Tel: 86-755-8864-2200</p> <p>China - Suzhou Tel: 86-186-6233-1526</p> <p>China - Wuhan Tel: 86-27-5980-5300</p> <p>China - Xian Tel: 86-29-8833-7252</p> <p>China - Xiamen Tel: 86-592-2388138</p> <p>China - Zhuhai Tel: 86-756-3210040</p>	<p>India - Bangalore Tel: 91-80-3090-4444</p> <p>India - New Delhi Tel: 91-11-4160-8631</p> <p>India - Pune Tel: 91-20-4121-0141</p> <p>Japan - Osaka Tel: 81-6-6152-7160</p> <p>Japan - Tokyo Tel: 81-3-6880-3770</p> <p>Korea - Daegu Tel: 82-53-744-4301</p> <p>Korea - Seoul Tel: 82-2-554-7200</p> <p>Malaysia - Kuala Lumpur Tel: 60-3-7651-7906</p> <p>Malaysia - Penang Tel: 60-4-227-8870</p> <p>Philippines - Manila Tel: 63-2-634-9065</p> <p>Singapore Tel: 65-6334-8870</p> <p>Taiwan - Hsin Chu Tel: 886-3-577-8366</p> <p>Taiwan - Kaohsiung Tel: 886-7-213-7830</p> <p>Taiwan - Taipei Tel: 886-2-2508-8600</p> <p>Thailand - Bangkok Tel: 66-2-694-1351</p> <p>Vietnam - Ho Chi Minh Tel: 84-28-5448-2100</p>	<p>Austria - Wels Tel: 43-7242-2244-39 Fax: 43-7242-2244-393</p> <p>Denmark - Copenhagen Tel: 45-4485-5910 Fax: 45-4485-2829</p> <p>Finland - Espoo Tel: 358-9-4520-820</p> <p>France - Paris Tel: 33-1-69-53-63-20 Fax: 33-1-69-30-90-79</p> <p>Germany - Garching Tel: 49-8931-9700</p> <p>Germany - Haan Tel: 49-2129-3766400</p> <p>Germany - Heilbronn Tel: 49-7131-72400</p> <p>Germany - Karlsruhe Tel: 49-721-625370</p> <p>Germany - Munich Tel: 49-89-627-144-0 Fax: 49-89-627-144-44</p> <p>Germany - Rosenheim Tel: 49-8031-354-560</p> <p>Israel - Ra'anana Tel: 972-9-744-7705</p> <p>Italy - Milan Tel: 39-0331-742611 Fax: 39-0331-466781</p> <p>Italy - Padova Tel: 39-049-7625286</p> <p>Netherlands - Drunen Tel: 31-416-690399 Fax: 31-416-690340</p> <p>Norway - Trondheim Tel: 47-72884388</p> <p>Poland - Warsaw Tel: 48-22-3325737</p> <p>Romania - Bucharest Tel: 40-21-407-87-50</p> <p>Spain - Madrid Tel: 34-91-708-08-90 Fax: 34-91-708-08-91</p> <p>Sweden - Gothenberg Tel: 46-31-704-60-40</p> <p>Sweden - Stockholm Tel: 46-8-5090-4654</p> <p>UK - Wokingham Tel: 44-118-921-5800 Fax: 44-118-921-5820</p>