

**MSCSM120TAM16CTPAG**  
**Datasheet**  
**Triple Phase Leg SiC MOSFET Power Module**

January 2020



---

a  **MICROCHIP** company

# Contents

---

<b>Revision History</b> .....	<b>1</b>
1.1 Revision 1.0.....	1
<b>Product Overview</b> .....	<b>2</b>
2.1 Features.....	3
2.2 Benefits.....	3
2.3 Applications.....	3
<b>Electrical Specifications</b> .....	<b>4</b>
3.1 SiC MOSFET Characteristics (Per MOSFET).....	4
3.2 Reverse SiC Diode Ratings and Characteristics (Per SiC Diode).....	6
3.3 Thermal and Package Characteristics.....	6
3.4 Typical SiC MOSFET Performance Curves.....	8
3.5 Typical SiC Diode Performance Curves.....	11
<b>Package Specifications</b> .....	<b>12</b>
4.1 Package Outline Drawing.....	12

# 1 Revision History

---

The revision history describes the changes that were implemented in the document. The changes are listed by revision, starting with the most current publication.

## 1.1 Revision 1.0

Revision 1.0 was published in January 2020. It is the first publication of this document.

## 2 Product Overview

The MSCSM120TAM16CTPAG device is a 3 phase leg 1200 V/171 A full Silicon Carbide (SiC) power module.

**Figure 1 • MSCSM120TAM16CTPAG Electrical Schematic**

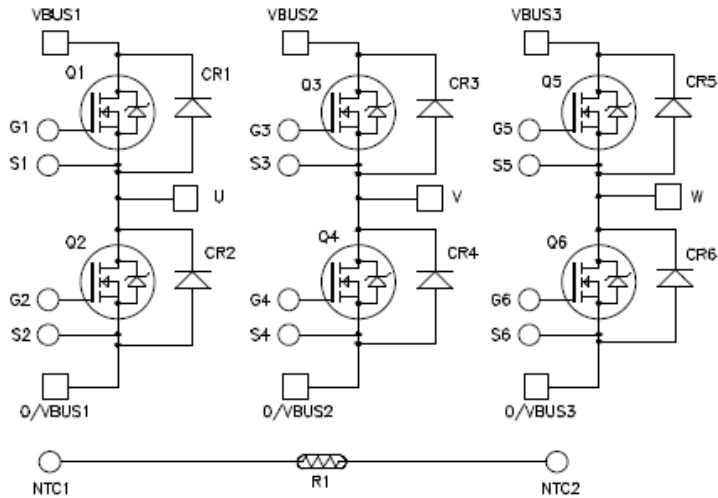

**Figure 2 • MSCSM120TAM16CTPAG Pinout Location**

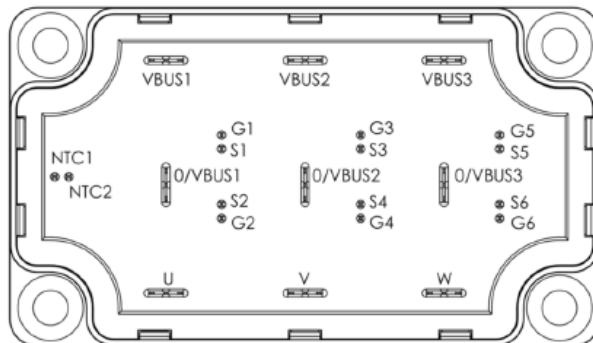

All ratings at  $T_j = 25\text{ }^\circ\text{C}$ , unless otherwise specified.

**Caution:** These devices are sensitive to electrostatic discharge. Proper handling procedures should be followed.

## 2.1 Features

The following are key features of the MSCSM120TAM16CTPAG device:

- SiC Power MOSFET
  - High temperature performance
  - Low  $R_{DS(on)}$
- SiC Schottky Diode
  - Zero reverse recovery
  - Zero forward recovery
  - Temperature Independent switching behavior
  - Positive temperature coefficient on VF
- Very low stray inductance
- Internal thermistor for temperature monitoring
- Aluminum nitride (AlN) substrate for improved thermal performance

## 2.2 Benefits

The following are benefits of the MSCSM120TAM16CTPAG device:

- High power and efficient converters and inverters
- Outstanding performance at high frequency operation
- Direct mounting to heatsink (isolated package)
- Low junction-to-case thermal resistance
- Solderable terminals for power and signal, for easy PCB mounting
- Low profile
- RoHS compliant

## 2.3 Applications

The MSCSM120TAM16CTPAG device is designed for the following applications:

- Uninterruptible power supplies
- Switched mode power supplies
- EV motor and traction drive
- Welding converters

## 3 Electrical Specifications

This section shows the electrical specifications of the MSCSM120TAM16CTPAG device.

### 3.1 SiC MOSFET Characteristics (Per MOSFET)

The following table shows the absolute maximum ratings per MOSFET of the MSCSM120TAM16CTPAG device.

**Table 1 • Absolute Maximum Ratings**

Symbol	Parameter	Max Ratings	Unit
$V_{DSS}$	Drain-source voltage	1200	V
$I_D$	Continuous drain current	$T_C = 25\text{ }^\circ\text{C}$	171 <sup>1</sup>
		$T_C = 80\text{ }^\circ\text{C}$	136 <sup>1</sup>
$I_{DM}$	Pulsed drain current	350	
$V_{GS}$	Gate-source voltage	-10/25	V
$R_{DS(on)}$	Drain-source ON resistance	16	m $\Omega$
$P_D$	Power dissipation	$T_C = 25\text{ }^\circ\text{C}$	728

**Note:**

1. Specification of SiC MOSFET device, but output current must be limited due to size of power connectors.

The following table shows the electrical characteristics per MOSFET of the MSCSM120TAM16CTPAG device.

**Table 2 • Electrical Characteristics**

Symbol	Characteristic	Test Conditions	Min	Typ	Max	Unit
$I_{DSS}$	Zero gate voltage drain current	$V_{GS} = 0\text{ V}; V_{DS} = 1200\text{ V}$		20	200	$\mu\text{A}$
$R_{DS(on)}$	Drain-source on resistance	$V_{GS} = 20\text{ V}$ $I_D = 80\text{ A}$	$T_J = 25\text{ }^\circ\text{C}$		12.5	16
			$T_J = 175\text{ }^\circ\text{C}$		20	
$V_{GS(th)}$	Gate threshold voltage	$V_{GS} = V_{DS}, I_D = 2\text{ mA}$	1.8	2.8		V
$I_{GSS}$	Gate-source leakage current	$V_{GS} = 20\text{ V}, V_{DS} = 0\text{ V}$			200	nA

The following table shows the dynamic characteristics per MOSFET of the MSCSM120TAM16CTPAG device.

**Table 3 • Dynamic Characteristics**

Symbol	Characteristic	Test Conditions	Min	Typ	Max	Unit
$C_{iss}$	Input capacitance	$V_{GS} = 0\text{ V}$ $V_{DS} = 1000\text{ V}$ $f = 1\text{ MHz}$		6040		pF
$C_{oss}$	Output capacitance			540		
$C_{rss}$	Reverse transfer capacitance			50		
$Q_g$	Total gate charge	$V_{GS} = -5\text{ V}/20\text{ V}$ $V_{BUS} = 800\text{ V}$ $I_D = 80\text{ A}$		464		nC
$Q_{gs}$	Gate-source charge			82		
$Q_{gd}$	Gate-drain charge			100		
$T_{d(on)}$	Turn-on delay time	$V_{GS} = -5\text{ V}/20\text{ V}$ $V_{BUS} = 600\text{ V}$ $I_D = 100\text{ A}$ $R_{Gon} = 4\ \Omega$ ; $R_{Goff} = 2.4\ \Omega$		30		ns
$T_r$	Rise time			30		
$T_{d(off)}$	Turn-off delay time			50		
$T_f$	Fall time			25		
$E_{on}$	Turn on energy	Inductive switching $V_{GS} = -5\text{ V}/20\text{ V}$	$T_j = 150\text{ }^\circ\text{C}$	1.98		mJ
$E_{off}$	Turn off energy	$V_{BUS} = 600\text{ V}$ $I_D = 100\text{ A}$ $R_{Gon} = 4\ \Omega$ $R_{Goff} = 2.4\ \Omega$	$T_j = 150\text{ }^\circ\text{C}$	1.3		mJ
$R_{Gint}$	Internal gate resistance			2.94		$\Omega$
$R_{thJC}$	Junction-to-case thermal resistance				0.206	$^\circ\text{C}/\text{W}$

The following table shows the body diode ratings and characteristics per MOSFET of the MSCSM120TAM16CTPAG device.

**Table 4 • Body Diode Ratings and Characteristics**

Symbol	Characteristic	Test Conditions	Min	Typ	Max	Unit
$V_{SD}$	Diode forward voltage	$V_{GS} = 0\text{ V}$ ; $I_{SD} = 80\text{ A}$		4.0		V
		$V_{GS} = -5\text{ V}$ ; $I_{SD} = 80\text{ A}$		4.2		
$t_{rr}$	Reverse recovery time	$I_{SD} = 80\text{ A}$ ; $V_{GS} = -5\text{ V}$ $V_R = 800\text{ V}$ ; $d_i/dt = 2000\text{ A}/\mu\text{s}$		90		ns
$Q_{rr}$	Reverse recovery charge			1100		nC
$I_{rr}$	Reverse recovery current				27	

### 3.2 Reverse SiC Diode Ratings and Characteristics (Per SiC Diode)

The following table shows the reverse SiC diode ratings and characteristics of the MSCSM120TAM16CTPAG device.

**Table 5 • Reverse SiC Diode Ratings and Characteristics (Per SiC Diode)**

Symbol	Characteristic	Test Conditions		Min	Typ	Max	Unit
$V_{RRM}$	Peak repetitive reverse voltage					1200	V
$I_{RM}$	Reverse leakage current	$V_R = 1200\text{ V}$	$T_J = 25\text{ }^\circ\text{C}$	15	400		$\mu\text{A}$
			$T_J = 175\text{ }^\circ\text{C}$	250			
$I_F$	DC forward current				50		A
$V_F$	Diode forward voltage	$I_F = 50\text{ A}$	$T_J = 25\text{ }^\circ\text{C}$	1.5	1.8		V
			$T_J = 175\text{ }^\circ\text{C}$	2.1			
QC	Total capacitive charge	$V_R = 600\text{ V}$			224		nC
C	Total capacitance	$f = 1\text{ MHz}, V_R = 400\text{ V}$			246		$\text{pF}$
		$f = 1\text{ MHz}, V_R = 800\text{ V}$			182		
$R_{thJC}$	Junction-to-case thermal resistance					0.573	$^\circ\text{C/W}$

### 3.3 Thermal and Package Characteristics

The following table shows the package characteristics of the MSCSM120TAM16CTPAG device.

**Table 6 • Package Characteristics**

Symbol	Characteristic			Min	Max	Unit
$V_{ISOL}$	RMS isolation voltage, any terminal to case $t = 1\text{ min}$ , 50 Hz/60 Hz			4000		V
$T_J$	Operating junction temperature range			-40	175	$^\circ\text{C}$
$T_{JOP}$	Recommended junction temperature under switching conditions			-40	$T_{Jmax} - 25$	
$T_{STG}$	Storage temperature range			-40	125	
$T_C$	Operating case temperature			-40	125	
Torque	Mounting torque	To heatsink	M6	3	5	N.m
Wt	Package weight				250	g



The following table shows the temperature sensor NTC (see application note [APT0406](#) on [www.microsemi.com](http://www.microsemi.com)) of the MSCSM120TAM16CTPAG device.

**Table 7 • Temperature Sensor NTC**

Symbol	Characteristic	Min	Typ	Max	Unit
R <sub>25</sub>	Resistance at 25 °C		50		kΩ
ΔR <sub>25</sub> /R <sub>25</sub>			5		%
B <sub>25/85</sub>	T <sub>25</sub> = 298.15 K		3952		K
ΔB/B			4		%
					T <sub>C</sub> = 100 °C

$$R_T = \frac{R_{25}}{\exp\left[B_{25/85}\left(\frac{1}{T_{25}} - \frac{1}{T}\right)\right]}$$

T: Thermistor temperature  
 R<sub>T</sub>: Thermistor value at T

### 3.4 Typical SiC MOSFET Performance Curves

This section shows the typical SiC MOSFET performance curves of the MSCSM120TAM16CTPAG device.

**Figure 3 • Maximum Thermal Impedance**

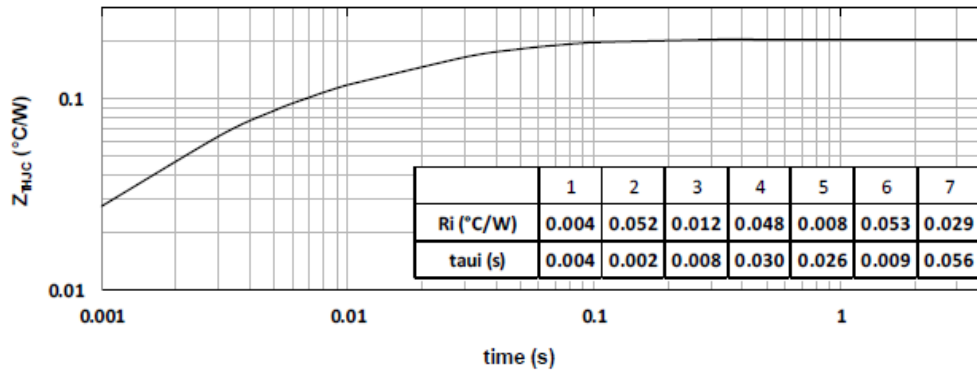

**Figure 4 • Output Characteristics,  $T_J = 25^\circ\text{C}$**

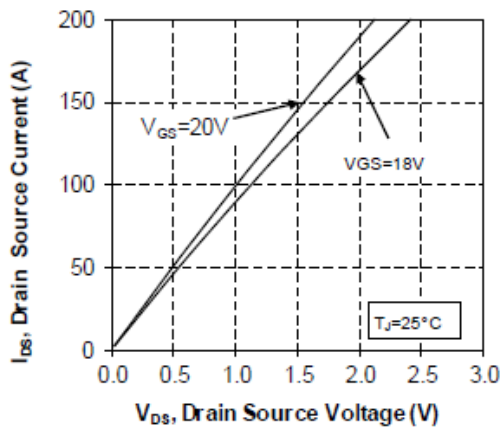

**Figure 5 • Output Characteristics,  $T_J = 175^\circ\text{C}$**

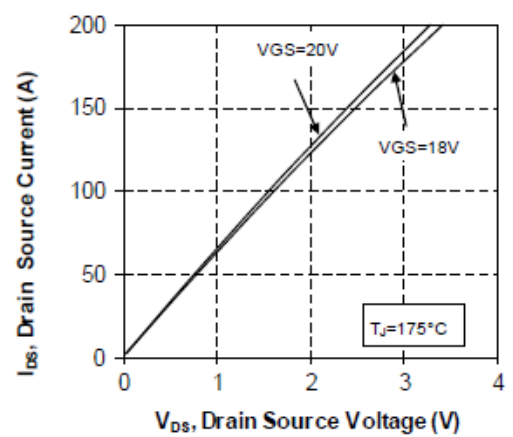

**Figure 6 • Normalized  $R_{DS(on)}$  vs. Temperature**

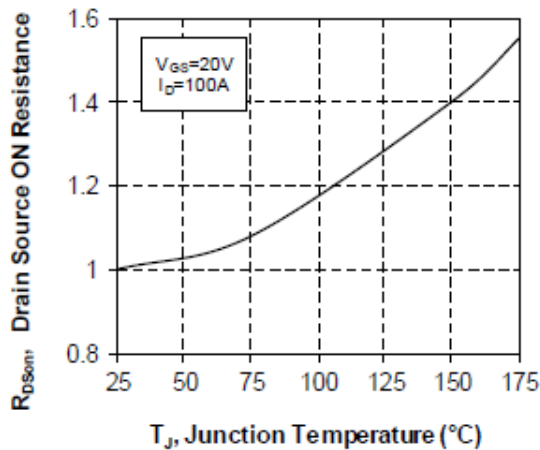

**Figure 7 • Transfer Characteristics**

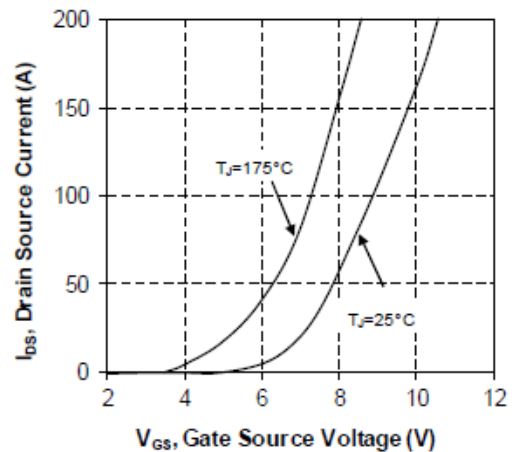

Figure 8 • Switching Energy vs. Rg

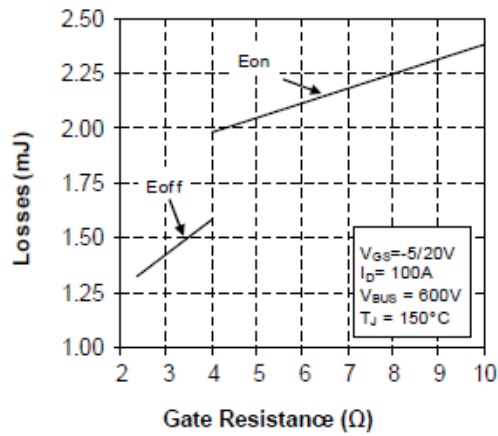

Figure 9 • Switching Energy vs. Current

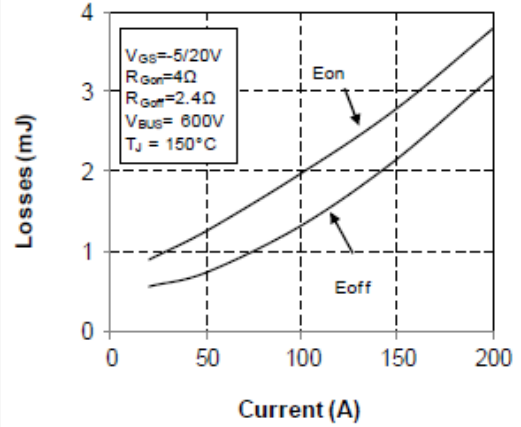

Figure 10 • Capacitance vs. Drain Source Voltage

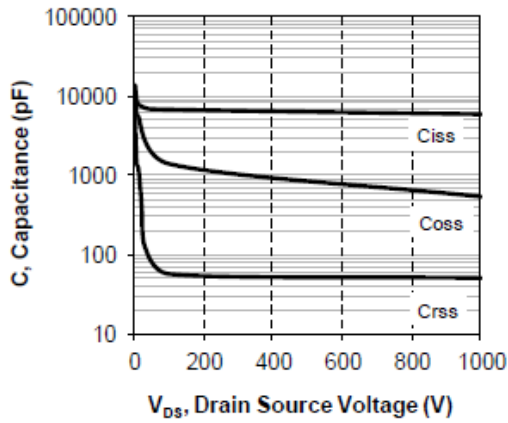

Figure 11 • Gate Charge vs. Gate Source Voltage

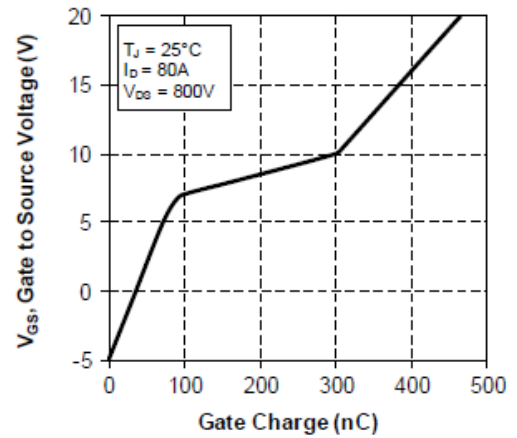

Figure 12 • Body Diode Characteristics, TJ = 25 °C

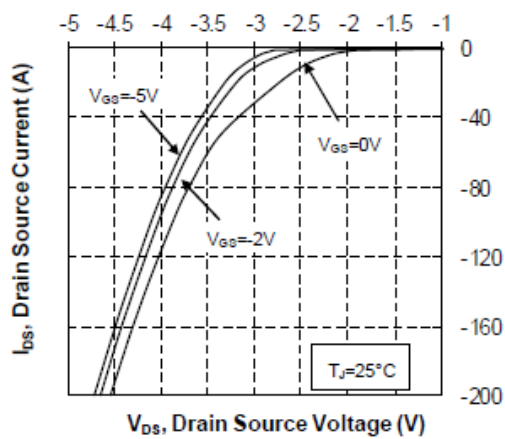

Figure 13 • 3<sup>rd</sup> Quadrant Characteristics, TJ = 25 °C

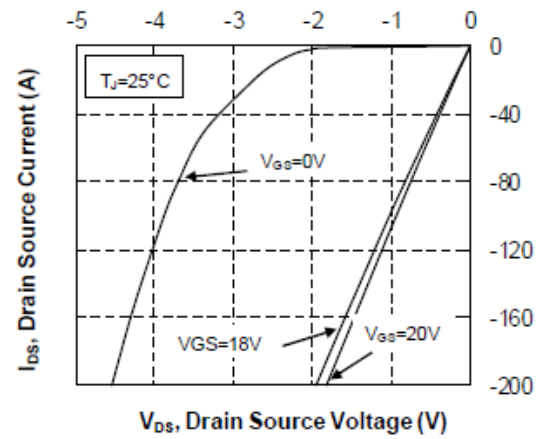

Figure 14 • Body Diode Characteristics,  $T_J = 175^\circ\text{C}$

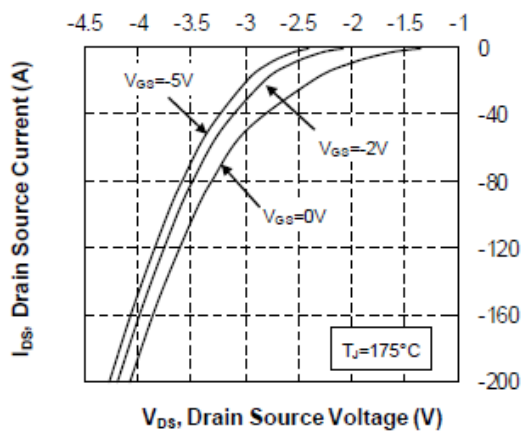

Figure 15 • 3<sup>rd</sup> Quadrant Characteristics,  $T_J = 175^\circ\text{C}$

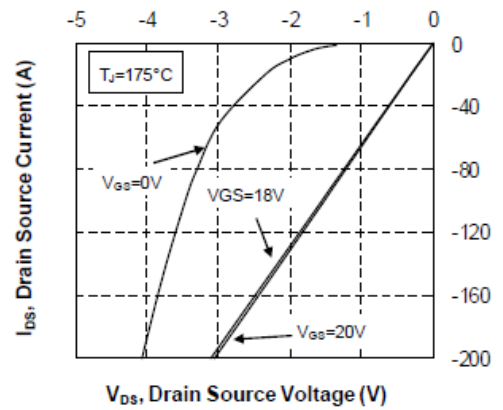
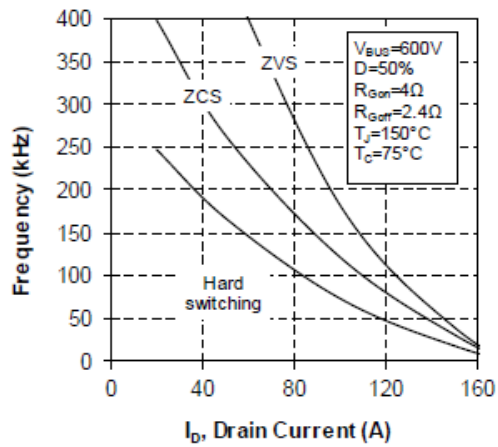

Figure 16 • Operating Frequency vs. Drain Current



### 3.5 Typical SiC Diode Performance Curves

This sections shows the typical SiC diode performance curves of the MSCSM120TAM16CTPAG device.

**Figure 17 • Maximum Thermal Impedance**

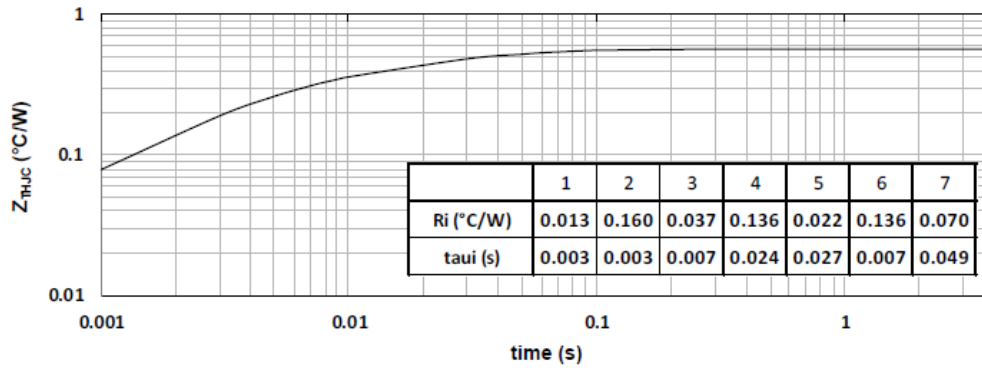

**Figure 18 • Forward Characteristics**

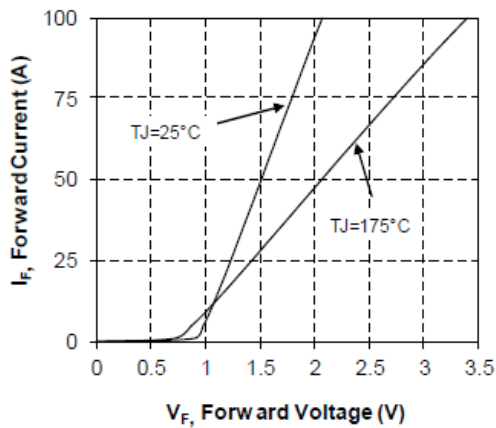

**Figure 19 • Capacitance vs. Reverse Voltage**

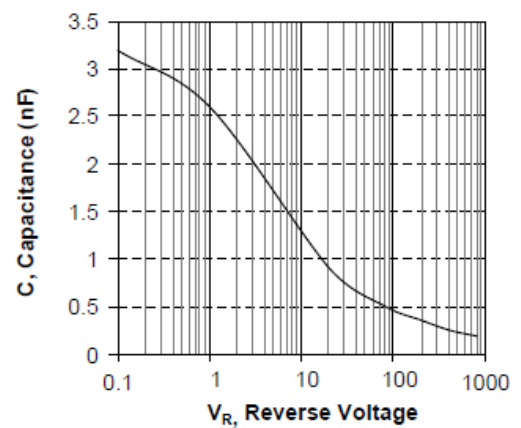

## 4 Package Specifications

This section shows the package specification of the MSCSM120TAM16CTPAG device.

### 4.1 Package Outline Drawing

The following figure illustrates the package outline of the MSCSM120TAM16CTPAG device. The dimensions in the following figure are in millimeters.

Figure 20 • Package Outline Drawing

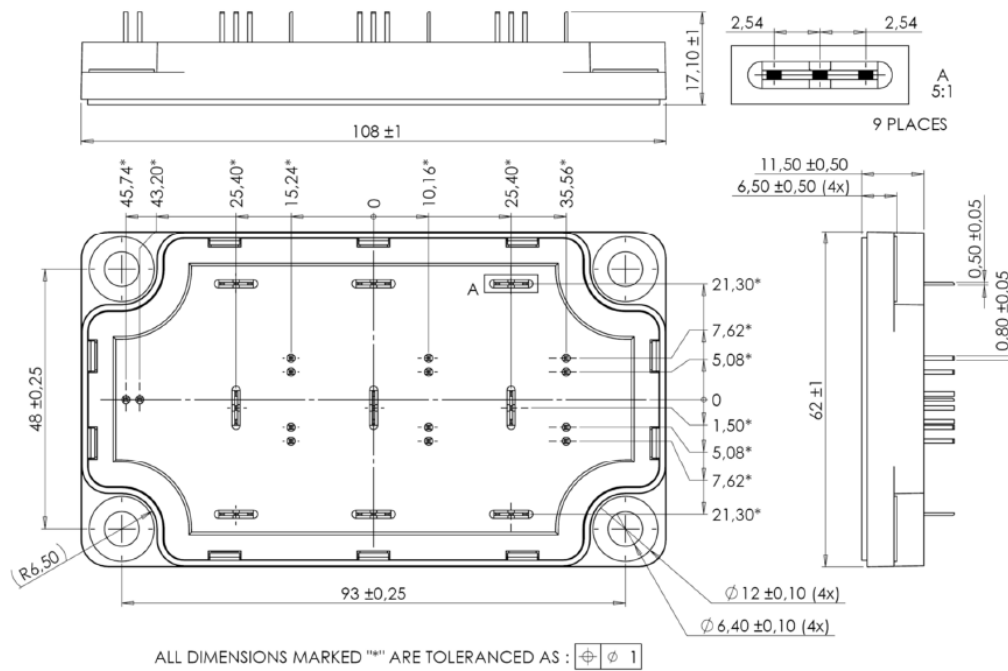

**Note:** See application note [1902 - Mounting Instructions for SP6-P \(12 mm\) Power Modules](#) on [www.microsemi.com](http://www.microsemi.com)

**Microsemi**

2355 W. Chandler Blvd.  
Chandler, AZ 85224 USA

Within the USA: +1 (480) 792-7200  
Fax: +1 (480) 792-7277

www.microsemi.com © 2020 Microsemi and its corporate affiliates. All rights reserved. Microsemi and the Microsemi logo are trademarks of Microsemi Corporation and its corporate affiliates. All other trademarks and service marks are the property of their respective owners.

Microsemi's product warranty is set forth in Microsemi's Sales Order Terms and Conditions. Information contained in this publication is provided for the sole purpose of designing with and using Microsemi products. Information regarding device applications and the like is provided only for your convenience and may be superseded by updates. Buyer shall not rely on any data and performance specifications or parameters provided by Microsemi. It is your responsibility to ensure that your application meets with your specifications. THIS INFORMATION IS PROVIDED "AS IS." MICROSEMI MAKES NO REPRESENTATIONS OR WARRANTIES OF ANY KIND WHETHER EXPRESS OR IMPLIED, WRITTEN OR ORAL, STATUTORY OR OTHERWISE, RELATED TO THE INFORMATION, INCLUDING BUT NOT LIMITED TO ITS CONDITION, QUALITY, PERFORMANCE, NON-INFRINGEMENT, MERCHANTABILITY OR FITNESS FOR A PARTICULAR PURPOSE. IN NO EVENT WILL MICROSEMI BE LIABLE FOR ANY INDIRECT, SPECIAL, PUNITIVE, INCIDENTAL OR CONSEQUENTIAL LOSS, DAMAGE, COST OR EXPENSE WHATSOEVER RELATED TO THIS INFORMATION OR ITS USE, HOWEVER CAUSED, EVEN IF MICROSEMI HAS BEEN ADVISED OF THE POSSIBILITY OR THE DAMAGES ARE FORESEEABLE. TO THE FULLEST EXTENT ALLOWED BY LAW, MICROSEMI'S TOTAL LIABILITY ON ALL CLAIMS IN RELATED TO THIS INFORMATION OR ITS USE WILL NOT EXCEED THE AMOUNT OF FEES, IF ANY, YOU PAID DIRECTLY TO MICROSEMI FOR THIS INFORMATION. Use of Microsemi devices in life support, mission-critical equipment or applications, and/or safety applications is entirely at the buyer's risk, and the buyer agrees to defend and indemnify Microsemi from any and all damages, claims, suits, or expenses resulting from such use. No licenses are conveyed, implicitly or otherwise, under any Microsemi intellectual property rights unless otherwise stated.

Microsemi Corporation, a subsidiary of Microchip Technology Inc. (Nasdaq: MCHP), and its corporate affiliates are leading providers of smart, connected and secure embedded control solutions. Their easy-to-use development tools and comprehensive product portfolio enable customers to create optimal designs which reduce risk while lowering total system cost and time to market. These solutions serve more than 120,000 customers across the industrial, automotive, consumer, aerospace and defense, communications and computing markets. Headquartered in Chandler, Arizona, the company offers outstanding technical support along with dependable delivery and quality. Learn more at [www.microsemi.com](http://www.microsemi.com).

MSCC-0344-DS-01065-1.0-0120