

MSC050SDA070B
Datasheet
Zero Recovery Silicon Carbide Schottky Diode

Final
May 2018



Contents

1	Revision History	1
1.1	Revision A	1
2	Product Overview	2
2.1	Features	2
2.2	Benefits	2
2.3	Applications	2
3	Electrical Specifications	3
3.1	Absolute Maximum Ratings	3
3.2	Electrical Performance	4
3.3	Performance Curves	5
4	Package Specification	7
4.1	Package Outline Drawing	7

1 Revision History

The revision history describes the changes that were implemented in the document. The changes are listed by revision, starting with the most current publication.

1.1 Revision A

Revision A was published in May 2018. It is the first publication of this document.

2 Product Overview

This section shows the product overview for the MSC050SDA070B device.

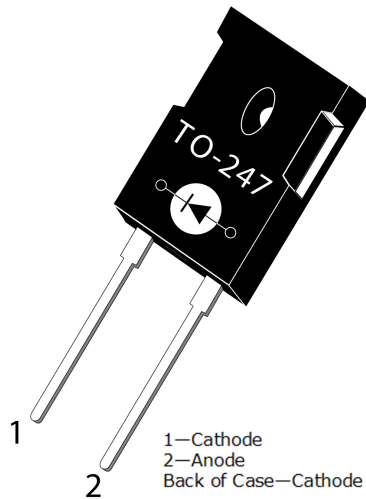

2.1 Features

The following are key features of the MSC050SDA070B device:

- Ultra-fast recovery times
- Soft recovery characteristics
- Low forward voltage
- Low leakage current
- Avalanche energy rated
- RoHS compliant

2.2 Benefits

The following are benefits of the MSC050SDA070B device:

- High switching frequency
- Low switching losses
- Low noise (EMI) switching
- Higher reliability systems
- Increased system power density

2.3 Applications

The MSC050SDA070B device is designed for the following applications:

- Power Factor Correction (PFC)
- Anti-parallel diode
 - Switch-mode power supply
 - Inverters/converters
 - Motor controllers
- Freewheeling diode
 - Switch-mode power supply
 - Inverters/converters
- Snubber/clamp diode

3 Electrical Specifications

This section shows the electrical specifications for the MSC050SDA070B device.

3.1 Absolute Maximum Ratings

The following table shows the absolute maximum ratings for the MSC050SDA070B device.

All ratings: $T_c = 25\text{ }^\circ\text{C}$ unless otherwise specified.

Table 1 • Absolute Maximum Ratings

Symbol	Parameter	Ratings	Unit
V_R	Maximum DC reverse voltage	700	V
V_{RRM}	Maximum peak repetitive reverse voltage	700	
V_{RWM}	Maximum working peak reverse voltage	700	
I_F	Maximum DC forward current ($T_c = 25\text{ }^\circ\text{C}$)	88	A
	Maximum DC forward current ($T_c = 135\text{ }^\circ\text{C}$)	39	
	Maximum DC forward current ($T_c = 145\text{ }^\circ\text{C}$)	32	
I_{FRM}	Repetitive peak forward surge current ($T_c = 25\text{ }^\circ\text{C}$, $t_p = 10\text{ ms}$, half sine wave)	128	
I_{FSM}	Non-repetitive forward surge current ($T_c = 25\text{ }^\circ\text{C}$, $t_p = 10\text{ ms}$, half sine wave)	124	
P_{tot}	Power dissipation ($T_c = 25\text{ }^\circ\text{C}$)	283	W
	Power dissipation ($T_c = 110\text{ }^\circ\text{C}$)	123	
T_J, T_{STG}	Operating and storage temperature range	-55 to 175	$^\circ\text{C}$
T_L	Lead temperature for 10 seconds	300	
E_{AS}	Single-pulse avalanche energy (starting $T_J = 25\text{ }^\circ\text{C}$, $L = 0.08\text{ mH}$, peak $I_L = 50\text{ A}$)	100	mJ

The following table shows the thermal and mechanical characteristics of the MSC050SDA070B device.

Table 2 • Thermal and Mechanical Characteristics

Symbol	Characteristic	Min	Typ	Max	Unit
$R_{\theta JC}$	Junction-to-case thermal resistance		0.37	0.53	$^\circ\text{C}/\text{W}$
W_T	Package weight		0.22		oz
			5.9		g
	Mounting torque, 6-32 or M3 screw			10	lbf-in
				1.1	N-m

3.2 Electrical Performance

The following table shows the static characteristics of the MSC050SDA070B device.

Table 3 • Static Characteristics

Symbol	Characteristic	Test Conditions	Typ	Max	Unit
V _F	Forward voltage	I _F = 50 A, T _J = 25 °C	1.5	1.8	V
		I _F = 50 A, T _J = 175 °C	1.9		
I _{RM}	Reverse leakage current	V _R = 700 V, T _J = 25 °C	15	200	μA
		V _R = 700 V, T _J = 175 °C	250		
Q _C	Total capacitive charge	V _R = 400 V, T _J = 25 °C	133		nC
C _J	Junction capacitance	V _R = 1 V, T _J = 25 °C, f = 1 MHz	2034		pF
	Junction capacitance	V _R = 200 V, T _J = 25 °C, f = 1 MHz	248		
	Junction capacitance	V _R = 400 V, T _J = 25 °C, f = 1 MHz	216		

3.3 Performance Curves

This section shows the typical performance curves for the MSC050SDA070B device.

Figure 1 • Maximum Transient Thermal Impedance

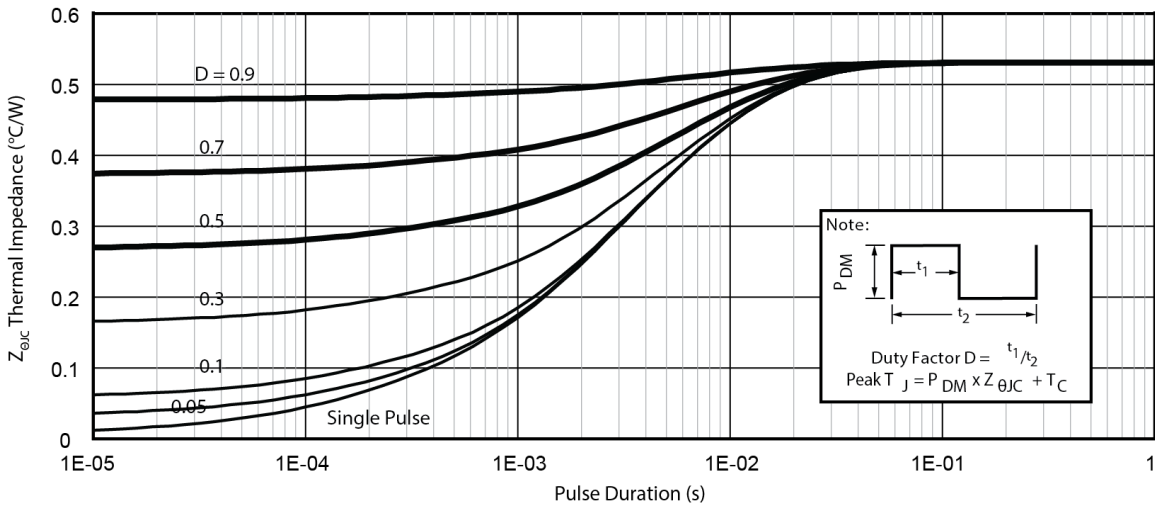

Figure 2 • Forward Current vs Forward Voltage

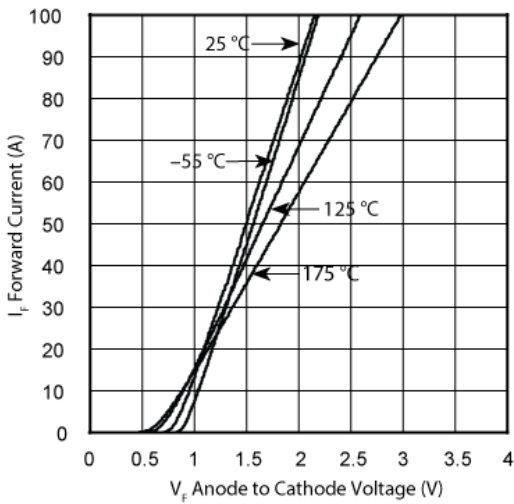

Figure 3 • Max Forward Current vs Case Temp

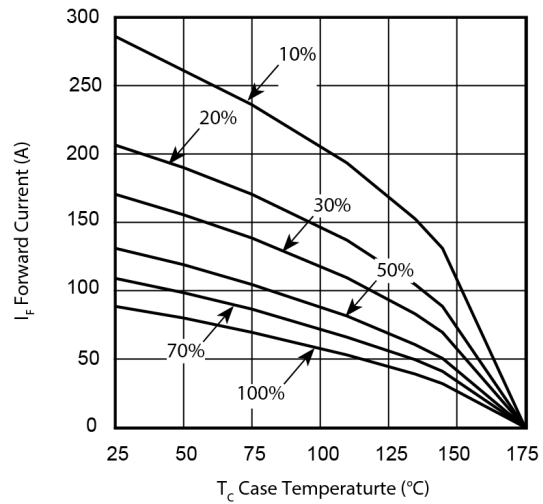

Figure 4 • Max Power Dissipation vs Case Temp

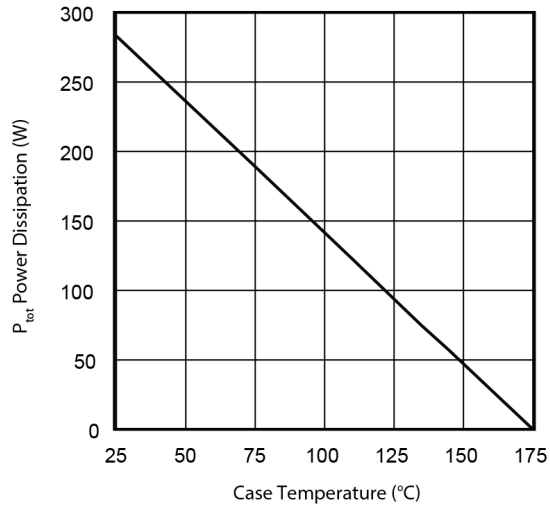

Figure 5 • Reverse Current vs. Reverse Voltage

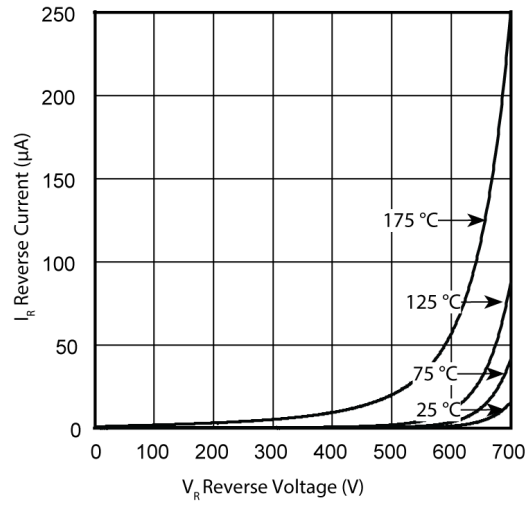

Figure 6 • Total Capacitive Charge vs. Reverse Voltage

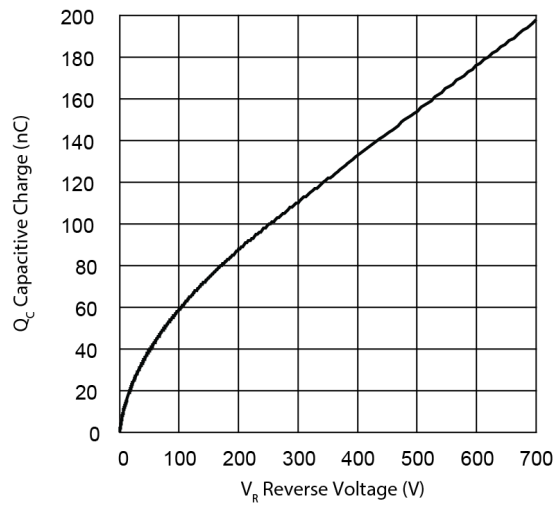
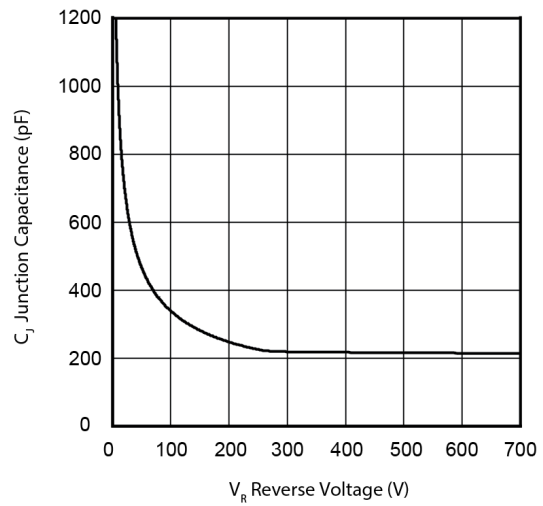

Figure 7 • Junction Capacitance vs Reverse Voltage



4 Package Specification

This section outlines the package specification for the MSC050SDA070B device.

4.1 Package Outline Drawing

This section shows the TO-247 package drawing of the MSC050SDA070B device. Dimensions are in millimeters and (inches).

Figure 8 • Package Outline Drawing

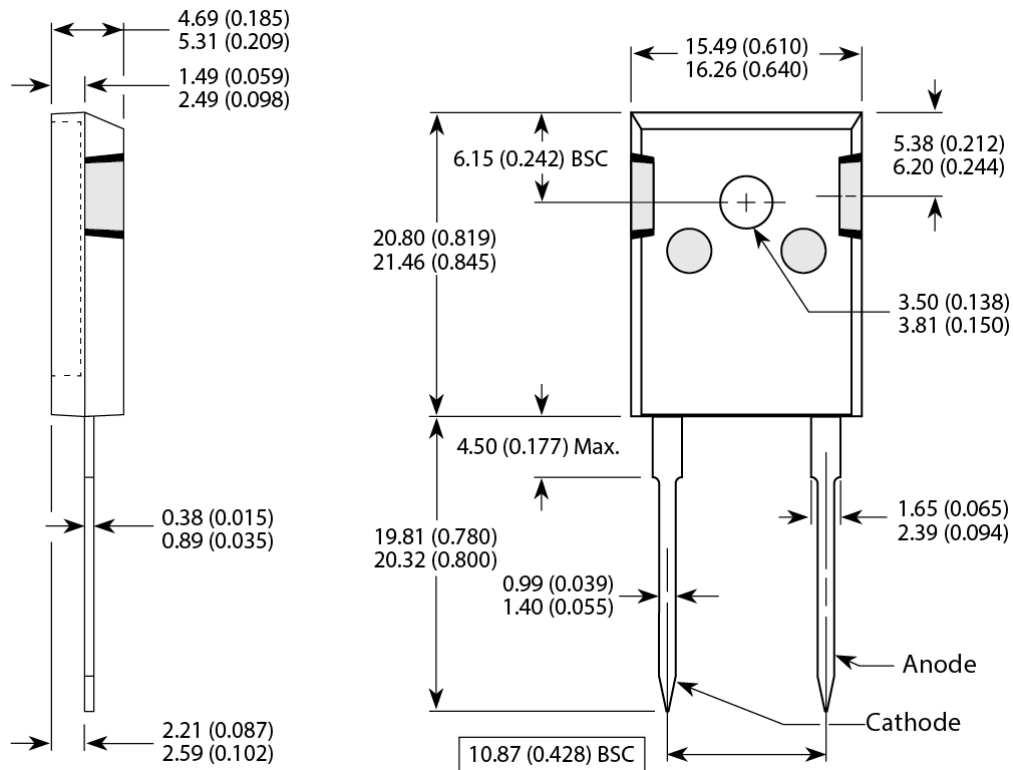

**Microsemi Corporate Headquarters**

One Enterprise, Aliso Viejo,
 CA 92656 USA
 Within the USA: +1 (800) 713-4113
 Outside the USA: +1 (949) 380-6100
 Fax: +1 (949) 215-4996
 Email: sales.support@microsemi.com
www.microsemi.com

© 2018 Microsemi Corporation. All rights reserved. Microsemi and the Microsemi logo are trademarks of Microsemi Corporation. All other trademarks and service marks are the property of their respective owners.

Microsemi makes no warranty, representation, or guarantee regarding the information contained herein or the suitability of its products and services for any particular purpose, nor does Microsemi assume any liability whatsoever arising out of the application or use of any product or circuit. The products sold hereunder and any other products sold by Microsemi have been subject to limited testing and should not be used in conjunction with mission-critical equipment or applications. Any performance specifications are believed to be reliable but are not verified, and Buyer must conduct and complete all performance and other testing of the products, alone and together with, or installed in, any end-products. Buyer shall not rely on any data and performance specifications or parameters provided by Microsemi. It is the Buyer's responsibility to independently determine suitability of any products and to test and verify the same. The information provided by Microsemi hereunder is provided "as is, where is" and with all faults, and the entire risk associated with such information is entirely with the Buyer. Microsemi does not grant, explicitly or implicitly, to any party any patent rights, licenses, or any other IP rights, whether with regard to such information itself or anything described by such information. Information provided in this document is proprietary to Microsemi, and Microsemi reserves the right to make any changes to the information in this document or to any products and services at any time without notice.

Microsemi Corporation (Nasdaq: MSCC) offers a comprehensive portfolio of semiconductor and system solutions for aerospace & defense, communications, data center and industrial markets. Products include high-performance and radiation-hardened analog mixed-signal integrated circuits, FPGAs, SoCs and ASICs; power management products; timing and synchronization devices and precise time solutions, setting the world's standard for time; voice processing devices; RF solutions; discrete components; enterprise storage and communication solutions; security technologies and scalable anti-tamper products; Ethernet solutions; Power-over-Ethernet ICs and midspans; as well as custom design capabilities and services. Microsemi is headquartered in Aliso Viejo, California, and has approximately 4,800 employees globally. Learn more at www.microsemi.com.

053-4080