



SGM8771

High Voltage, High Precision, Single Comparator with Voltage Reference

GENERAL DESCRIPTION

The SGM8771 is a single, high precision voltage comparator with a 1.225V voltage reference. The device optimized for high voltage operation from 2.8V to 36V single supply. It consumes low supply current without being affected by the supply voltage. Input common mode voltage is 1.5V lower than $+V_S$. The SGM8771 has an open-drain output structure that needs external pull-up resistor. It also has a 1.225V voltage reference that saves external reference and reduces system cost.

The SGM8771 features low input offset voltage of 2.4mV (MAX). It is suitable for applications requiring precision.

The SGM8771 is available in Green SOIC-8 and TDFN-3×3-8L packages. It is operated over the -40°C to +125°C temperature range.

FEATURES

- **Single Power Supply**
- **Wide Supply Voltage Range: 2.8V to 36V**
- **Low Supply Current: 180 μ A (TYP)**
- **Low Input Offset Voltage: 2.4mV (MAX)**
- **Low Input Bias Current: \pm 20pA (TYP)**
- **Minimum Input Common Mode Voltage: $-V_S$**
- **Maximum Differential Input Voltage: +36V/-36V**
- **Internal Voltage Reference: 1.225V**
- **Open-Drain Output Structure**
- **Low Output Saturation Voltage**
- **Supports CMOS or TTL Logic**
- **-40°C to +125°C Operating Temperature Range**
- **Available in Green SOIC-8 and TDFN-3×3-8L Packages**

APPLICATIONS

Power System Monitor
Medical Equipment
Industrial Application
Battery Management System

PACKAGE/ORDERING INFORMATION

MODEL	PACKAGE DESCRIPTION	SPECIFIED TEMPERATURE RANGE	ORDERING NUMBER	PACKAGE MARKING	PACKING OPTION
SGM8771	SOIC-8	-40°C to +125°C	SGM8771XS8G/TR	SGM 8771XS8 XXXXX	Tape and Reel, 4000
	TDFN-3x3-8L	-40°C to +125°C	SGM8771XTDB8G/TR	SGM 8771DB XXXXX	Tape and Reel, 4000

MARKING INFORMATION

NOTE: XXXXX = Date Code, Trace Code and Vendor Code.

XXXXX

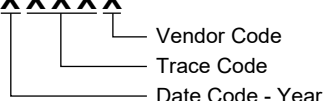

Green (RoHS & HSF): SG Micro Corp defines "Green" to mean Pb-Free (RoHS compatible) and free of halogen substances. If you have additional comments or questions, please contact your SGMICRO representative directly.

ABSOLUTE MAXIMUM RATINGS

- Supply Voltage, V_S 40V
- Differential Input Voltage, $|V_{ID}|$ 40V
- Input Voltage Range -0.3V to $(+V_S) + 0.3V$
- Output Voltage, V_{OUT} -0.3V to $(+V_S) + 0.3V$
- Output Voltage, V_{REF} -0.3V to 5.5V
- Junction Temperature..... +150°C
- Storage Temperature Range -65°C to +150°C
- Lead Temperature (Soldering, 10s).....+260°C
- ESD Susceptibility
- HBM..... 2000V
- CDM 1000V

RECOMMENDED OPERATING CONDITIONS

- Operating Temperature Range-40°C to +125°C
- Power Supply Range2.8V to 36V

OVERSTRESS CAUTION

Stresses beyond those listed in Absolute Maximum Ratings may cause permanent damage to the device. Exposure to absolute maximum rating conditions for extended periods may affect reliability. Functional operation of the device at any conditions beyond those indicated in the Recommended Operating Conditions section is not implied.

ESD SENSITIVITY CAUTION

This integrated circuit can be damaged if ESD protections are not considered carefully. SGMICRO recommends that all integrated circuits be handled with appropriate precautions. Failure to observe proper handling and installation procedures can cause damage. ESD damage can range from subtle performance degradation to complete device failure. Precision integrated circuits may be more susceptible to damage because even small parametric changes could cause the device not to meet the published specifications.

DISCLAIMER

SG Micro Corp reserves the right to make any change in circuit design, or specifications without prior notice.

PIN CONFIGURATIONS

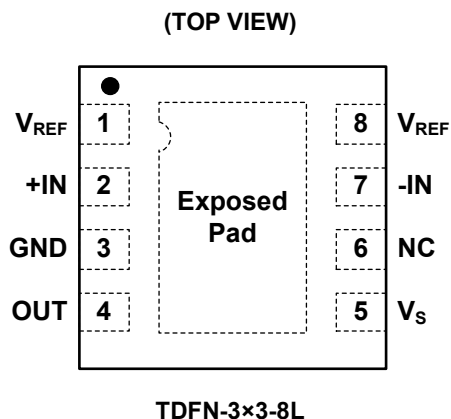
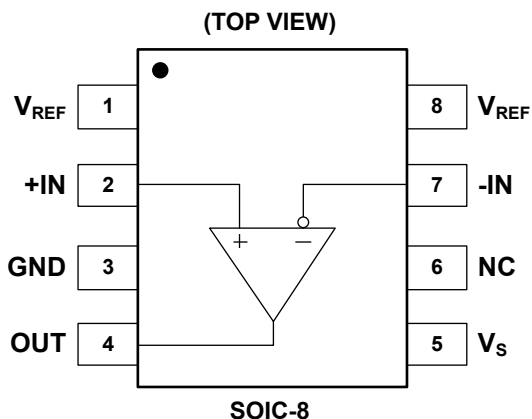

PIN DESCRIPTION

PIN	NAME	FUNCTION
1, 8	V _{REF}	Reference Output.
2	+IN	Non-Inverting Input of Comparator.
3	GND	Ground.
4	OUT	Output of Comparator.
5	V _S	Power Supply.
6	NC	No Connection.
7	-IN	Inverting Input of Comparator.
Exposed Pad	Exposed Pad	Exposed Pad (TDFN-3x3-8L Package Only). Exposed pad should be left floating.

ELECTRICAL CHARACTERISTICS(At $T_A = +25^\circ\text{C}$, $V_S = \pm 1.4\text{V}$ to $\pm 18\text{V}$, Full = -40°C to $+125^\circ\text{C}$, unless otherwise specified.)

PARAMETER	SYMBOL	CONDITIONS	TEMP	MIN	TYP	MAX	UNITS
Input Offset Voltage	V_{OS}	$V_{CM} = 0\text{V}$	$+25^\circ\text{C}$		0.6	2.4	mV
			Full			2.8	
Input Bias Current	I_B	$V_{CM} = 0\text{V}$	$+25^\circ\text{C}$		± 20	± 200	pA
Input Offset Current	I_{OS}	$V_{CM} = 0\text{V}$	$+25^\circ\text{C}$		± 20	± 200	pA
Maximum Differential Input Voltage	$ V_{ID} $		Full			V_S	V
Maximum Input Difference Bias Current	$ I_{ID} $	$V_S = \pm 18\text{V}$, $V_{ID} = \pm 18\text{V}$	$+25^\circ\text{C}$		2.2	4	μA
			Full			5	
Input Common Mode Voltage Range ⁽¹⁾	V_{CM}		Full	$-V_S$		$(+V_S) - 1.5\text{V}$	V
Common Mode Rejection Ratio	CMRR	$V_S = \pm 18\text{V}$, $V_{CM} = (-V_S)$ to $(+V_S) - 1.5\text{V}$	$+25^\circ\text{C}$	90	116		dB
			Full	87			
Power Supply Rejection Ratio	PSRR	$V_S = 2.8\text{V}$ to 36V	$+25^\circ\text{C}$	96	116		dB
			Full	93			
Large-Signal Differential Voltage Amplification	A_{VD}	$V_S = 36\text{V}$, $V_{OUT} = 0.1\text{V}$ to 28.8V , $R_L = 120\text{k}\Omega$ to V_S	$+25^\circ\text{C}$	90	100		dB
			Full	85			
Output Voltage Swing from Rail	V_{OL}	$I_{SINK} = 8\text{mA}$, $V_{ID} = -0.2\text{V}$	$+25^\circ\text{C}$		210	280	mV
			Full			400	
Output Short-Circuit Current	I_{SINK}	$V_{OL} = (-V_S) + 1.5\text{V}$, $V_{ID} = -0.2\text{V}$	$+25^\circ\text{C}$	25	36		mA
High-Level Output Current	I_{OH}	$V_{OH} = 2.8\text{V}$, $V_{ID} = 0.2\text{V}$	$+25^\circ\text{C}$		0.4	0.7	μA
			Full			1	
			$+25^\circ\text{C}$		6	8.5	
			Full			35	
Supply Current	I_S	$I_{OUT} = 0\text{mA}$	$+25^\circ\text{C}$		180	210	μA
			Full			250	
Voltage Reference	V_{REF}	$V_S = 2.8\text{V}$ to 36V , $I_{REF} = 0$ to 5mA	$+25^\circ\text{C}$	1.205	1.225	1.245	V

SWITCHING CHARACTERISTICS(At $T_A = +25^\circ\text{C}$, $V_S = \pm 2.5\text{V}$, $C_L = 15\text{pF}$ ⁽²⁾, unless otherwise noted.)

PARAMETER	SYMBOL	CONDITIONS	TEMP	MIN	TYP	MAX	UNITS
Propagation Delay (High to Low)	t_{PHL}	Overdrive = 10mV	$+25^\circ\text{C}$		85		ns
		Overdrive = 100mV	$+25^\circ\text{C}$		50		ns
Fall Time	t_{FALL}	Overdrive = 10mV	$+25^\circ\text{C}$		12		ns
		Overdrive = 100mV	$+25^\circ\text{C}$		12		ns

NOTES:

- Any input voltage should not be lower than $(-V_S) - 0.3\text{V}$. The maximum input common mode voltage is $(+V_S) - 1.5\text{V}$, but it will not be damaged when the upper limit of the input voltage reaches 36V .
- C_L : Load capacitance (jig and probe included).

TYPICAL PERFORMANCE CHARACTERISTICS

At $T_A = +25^\circ\text{C}$, $V_S = \pm 18\text{V}$ and $C_L = 15\text{pF}$, unless otherwise noted.

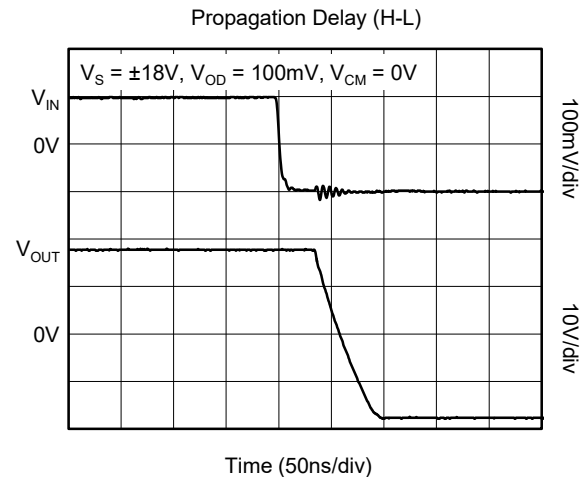
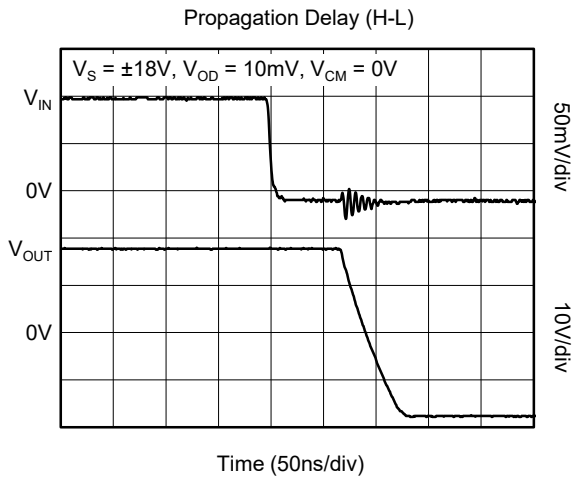
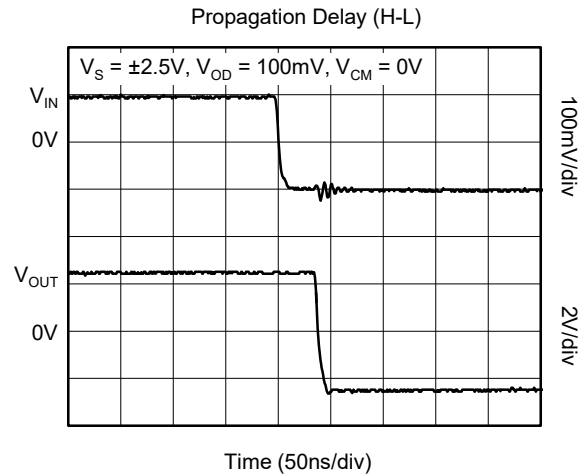
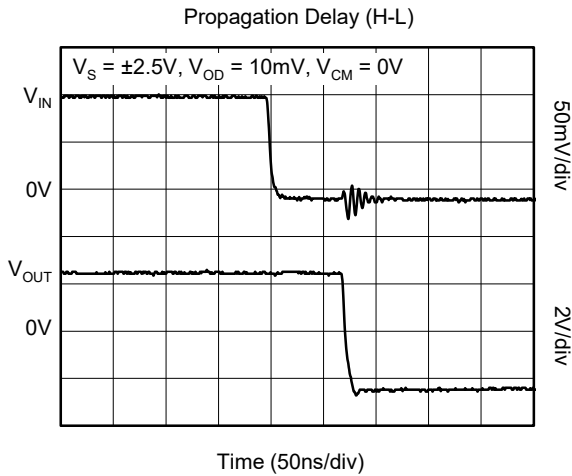
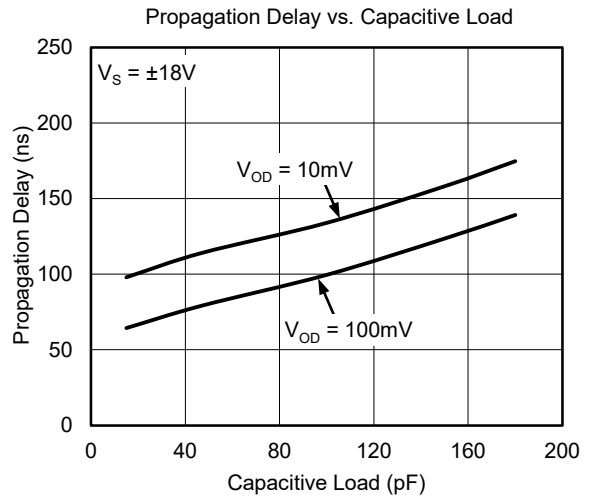
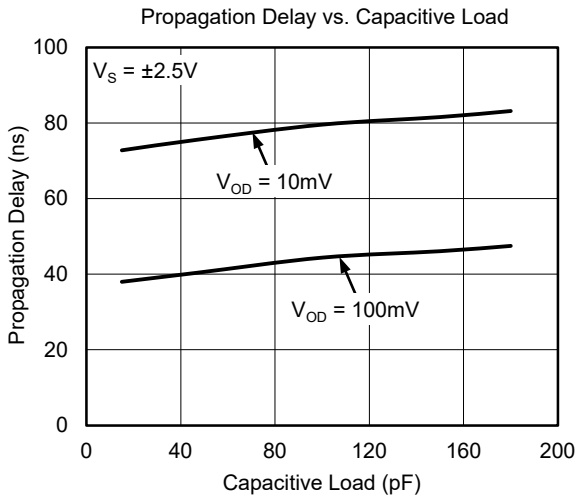

TYPICAL PERFORMANCE CHARACTERISTICS (continued)

At $T_A = +25^\circ\text{C}$, $V_S = \pm 18\text{V}$ and $C_L = 15\text{pF}$, unless otherwise noted.

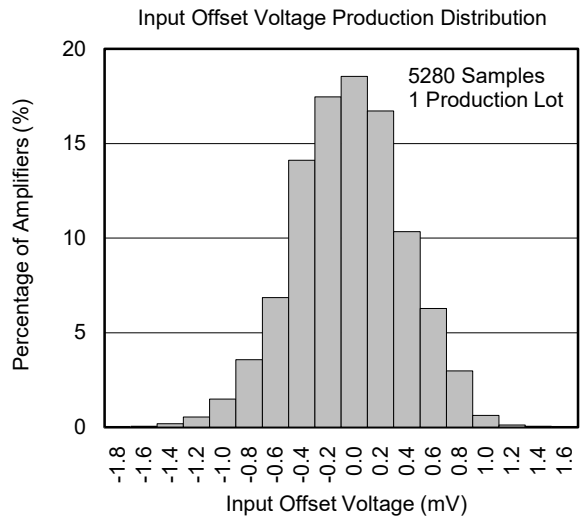
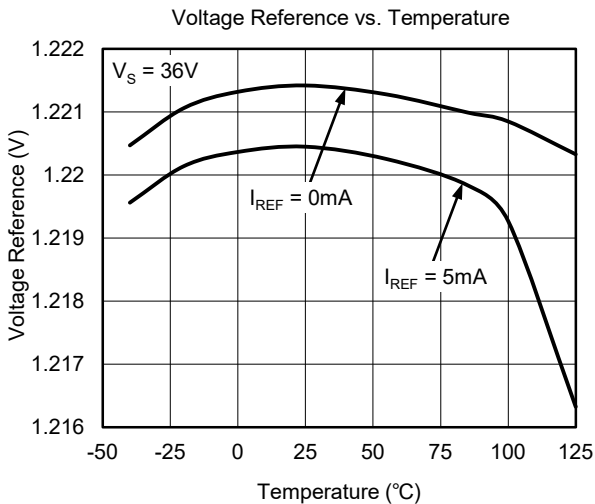
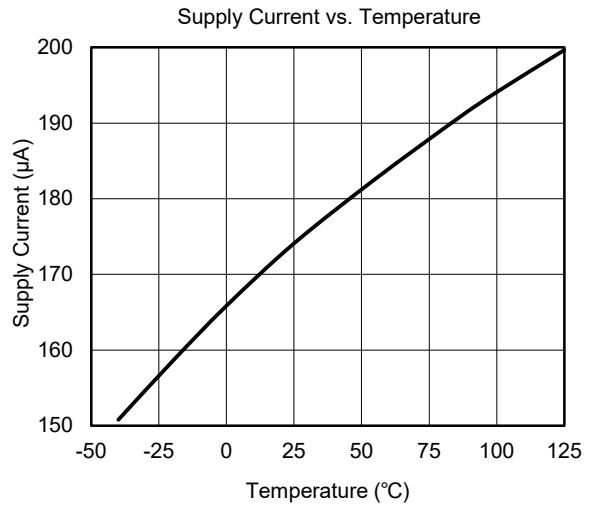
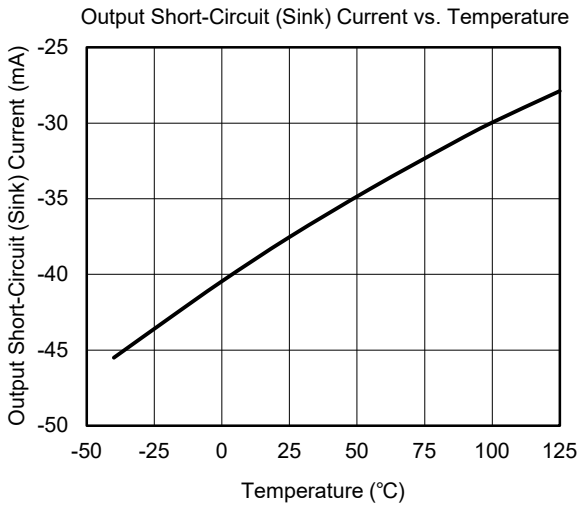
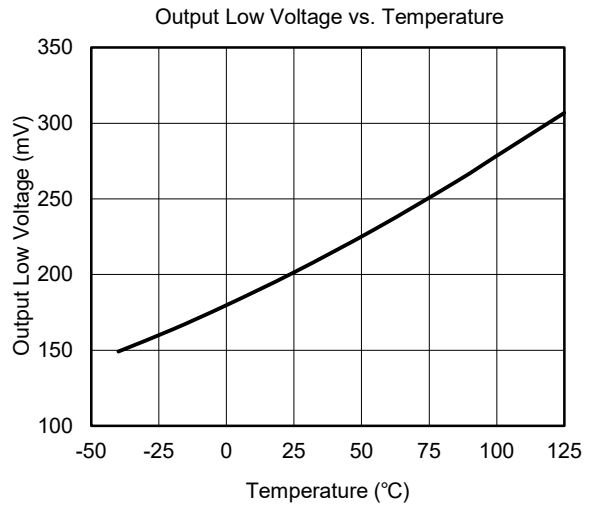
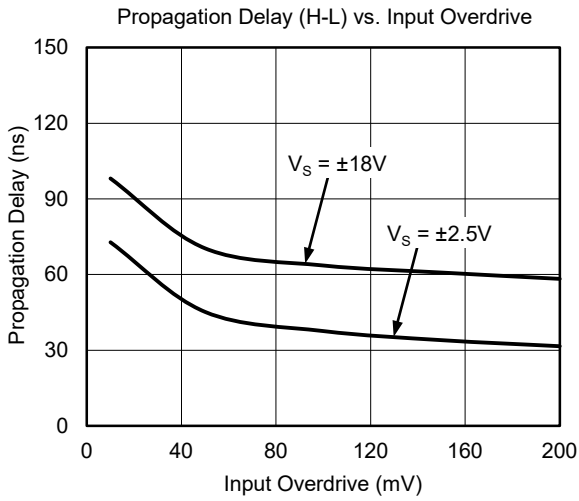

DETAILED DESCRIPTION

The SGM8771 is a single, high precision, low power comparator. The wide input voltage range and power supply range make the device a good choice for industrial equipment. Open-drain structure needs external pull-up resistor. The SGM8771 can be compatible with CMOS and TTL logics.

Output Structure

In Figure 1, the SGM8771 has an open-drain output stage. When output is changed from logic high to low, the changed sink current pulls output pin to logic low. Beginning this transition, larger sink current is used to create a high slew rate transit from high to low. Once the output voltage reaches V_{OL} , it will reduce the sink current to a just right value to maintain the V_{OL} static condition. This current-driven open-drain output stage will significantly reduce the power consumption in application system.

If low slew rate transition is needed in system design, adjusting the load capacitance will change the slew rate. The heavier capacitive load will slow down the output voltage transition. This feature will be used to reduce the interference generated by fast edge of transition between 1 and 0 in noise-sensitive system.

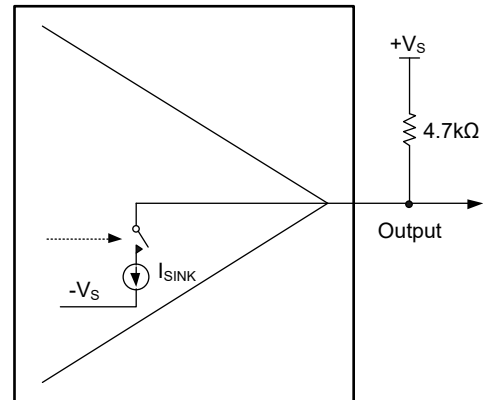

Figure 1. Open-Drain Output Structure

APPLICATION INFORMATION

Layout and Bypassing

Good power supply decoupling, layout and grounding are very important for SGM8771 to realize the full high-speed capabilities in system, following skills will be used:

- ◆ A 0.1μF to 4.7μF range ceramic capacitor is used to provide good power supply decoupling. This ceramic capacitor must be placed as close to V_S pin as possible.

- ◆ For grounding, unbroken and low-inductance ground plane is a good choice.
- ◆ For Layout, use short PCB trace to avoid unwanted parasitic feedback around the comparator. SGM8771 must be soldered directly to the PCB and the socket is not recommended.

REVISION HISTORY

NOTE: Page numbers for previous revisions may differ from page numbers in the current version.

Changes from Original (DECEMBER 2019) to REV.A

Page

Changed from product preview to production data.....All

PACKAGE OUTLINE DIMENSIONS

SOIC-8

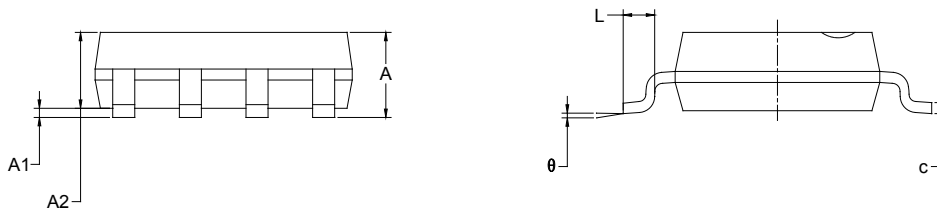
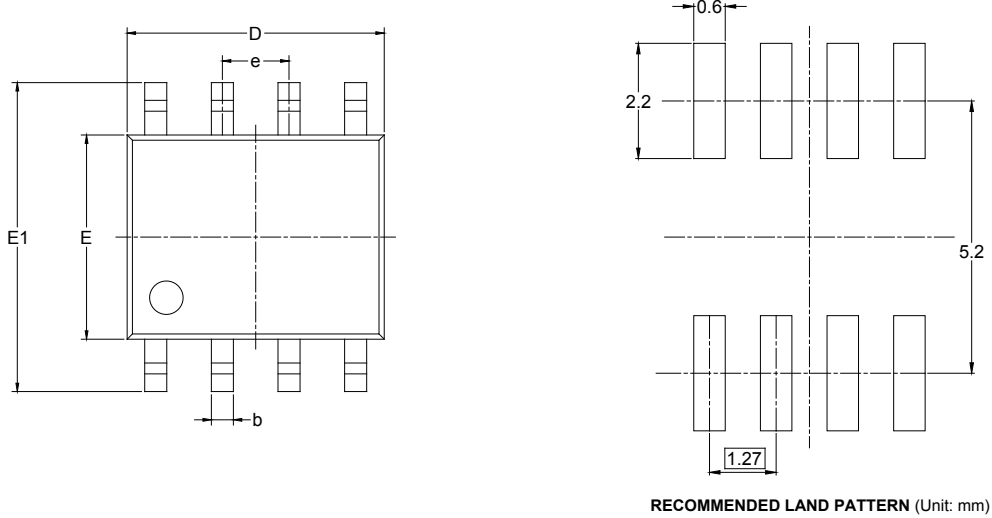

Symbol	Dimensions In Millimeters		Dimensions In Inches	
	MIN	MAX	MIN	MAX
A	1.350	1.750	0.053	0.069
A1	0.100	0.250	0.004	0.010
A2	1.350	1.550	0.053	0.061
b	0.330	0.510	0.013	0.020
c	0.170	0.250	0.006	0.010
D	4.700	5.100	0.185	0.200
E	3.800	4.000	0.150	0.157
E1	5.800	6.200	0.228	0.244
e	1.27 BSC		0.050 BSC	
L	0.400	1.270	0.016	0.050
θ	0°	8°	0°	8°

PACKAGE OUTLINE DIMENSIONS

TDFN-3x3-8L

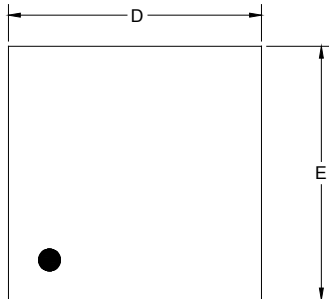

TOP VIEW

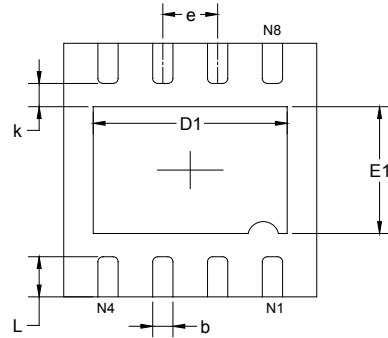

BOTTOM VIEW

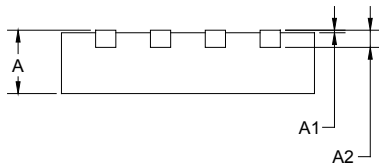

SIDE VIEW

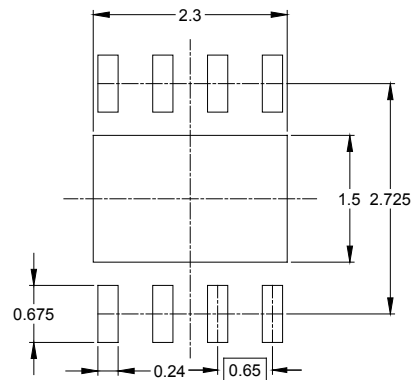

RECOMMENDED LAND PATTERN (Unit: mm)

Symbol	Dimensions In Millimeters		Dimensions In Inches	
	MIN	MAX	MIN	MAX
A	0.700	0.800	0.028	0.031
A1	0.000	0.050	0.000	0.002
A2	0.203 REF		0.008 REF	
D	2.900	3.100	0.114	0.122
D1	2.200	2.400	0.087	0.094
E	2.900	3.100	0.114	0.122
E1	1.400	1.600	0.055	0.063
k	0.200 MIN		0.008 MIN	
b	0.180	0.300	0.007	0.012
e	0.650 TYP		0.026 TYP	
L	0.375	0.575	0.015	0.023

TAPE AND REEL INFORMATION

REEL DIMENSIONS



TAPE DIMENSIONS



NOTE: The picture is only for reference. Please make the object as the standard.

KEY PARAMETER LIST OF TAPE AND REEL

Package Type	Reel Diameter	Reel Width W1 (mm)	A0 (mm)	B0 (mm)	K0 (mm)	P0 (mm)	P1 (mm)	P2 (mm)	W (mm)	Pin1 Quadrant
SOIC-8	13"	12.4	6.40	5.40	2.10	4.0	8.0	2.0	12.0	Q1
TDFN-3×3-8L	13"	12.4	3.35	3.35	1.13	4.0	8.0	2.0	12.0	Q1

DD0001

PACKAGE INFORMATION

CARTON BOX DIMENSIONS



NOTE: The picture is only for reference. Please make the object as the standard.

KEY PARAMETER LIST OF CARTON BOX

Reel Type	Length (mm)	Width (mm)	Height (mm)	Pizza/Carton
13"	386	280	370	5

DD0002