



# SGM8606

## 1.8V, Micro-Power, Precision, RRIO, CMOS Zero-Drift Operational Amplifier with Comparator and Voltage Reference

### GENERAL DESCRIPTION

The SGM8606 is a low power, high precision CMOS operational amplifier, integrated with one comparator and one low drift voltage reference. The device can operate from 1.8V to 5.5V single supply or from  $\pm 0.9V$  to  $\pm 2.75V$  dual power supplies, while consuming only 20 $\mu A$  quiescent current. The amplifier supports rail-to-rail input and output operation. Its input common mode voltage range is 100mV beyond the rails, and the output swings within 14mV of the rails. The device is suitable for low voltage operation, such as battery-powered applications.

The amplifier features high impedance inputs, a 50 $\mu V$  maximum input offset voltage and zero-drift over time and temperature. It is designed to provide optimal performance in low voltage and low power systems. These specifications make the device appropriate for a wide range of applications requiring high precision, such as driving ADCs without reducing differential linearity.

The comparator's input common mode voltage range is 200mV beyond the rails and the integrated voltage reference provides precise threshold in application.

The internal 1.2V series voltage reference features a low 42 $\mu V/^{\circ}C$  drift. It is stable for capacitive load up to 10nF, and can provide output current up to 2mA (TYP).

The SGM8606 fits in a tiny package with low power. It is well suited for mobile phones and handheld electronic applications.

The SGM8606 is available in a Green TDFN-3 $\times$ 3-10L package. It is rated over the -40 $^{\circ}C$  to +85 $^{\circ}C$  temperature range.

### FEATURES

- Quiescent Current: 20 $\mu A$  (TYP)
- Supply Voltage Range: 1.8V to 5.5V
- -40 $^{\circ}C$  to +85 $^{\circ}C$  Operating Temperature Range
- Available in a Green TDFN-3 $\times$ 3-10L Package

#### AMPLIFIER

- Low Offset Voltage: 50 $\mu V$  (MAX)
- Low 0.1Hz to 10Hz Noise: 2 $\mu V_{P-P}$
- Integrated RFI Filter
- Single-Supply Operation
- Rail-to-Rail Input and Output

#### COMPARATOR

- Comparator Push-Pull Output Current Drive: 18mA (TYP) at  $V_S = 5V$
- Comparator Rail-to-Rail Input

#### VOLTAGE REFERENCE

- 1.2V Voltage Reference
- Low 42 $\mu V/^{\circ}C$  Drift
- 2mA Output Drive Ability

### APPLICATIONS

Temperature Measurements  
Medical Instrumentation  
Battery-Powered Instruments  
IR Receivers  
Alarm and Monitoring Circuits

# 1.8V, Micro-Power, Precision, RRIO, CMOS Zero-Drift SGM8606 Operational Amplifier with Comparator and Voltage Reference

## PACKAGE/ORDERING INFORMATION

MODEL	PACKAGE DESCRIPTION	SPECIFIED TEMPERATURE RANGE	ORDERING NUMBER	PACKAGE MARKING	PACKING OPTION
SGM8606	TDFN-3x3-10L	-40°C to +85°C	SGM8606YTD10G/TR	SGM 8606D XXXXX	Tape and Reel, 4000

## MARKING INFORMATION

NOTE: XXXXX = Date Code and Vendor Code.

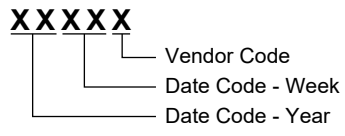

Green (RoHS & HSF): SG Micro Corp defines "Green" to mean Pb-Free (RoHS compatible) and free of halogen substances. If you have additional comments or questions, please contact your SGMICRO representative directly.

## ABSOLUTE MAXIMUM RATINGS

- Supply Voltage.....6V
- V<sub>IN</sub> Differential.....±(+V<sub>S</sub> - (-V<sub>S</sub>))
- Voltage at I/O Pins..... (-V<sub>S</sub>) - 0.3V to (+V<sub>S</sub>) + 0.3V
- Junction Temperature.....+150°C
- Storage Temperature Range.....-65°C to +150°C
- Lead Temperature (Soldering, 10s).....+260°C
- ESD Susceptibility
- HBM.....4000V
- MM.....400V
- CDM.....1000V

## RECOMMENDED OPERATING CONDITIONS

- Specified Voltage Range .....1.8V to 5.5V
- Operating Temperature Range .....-40°C to +85°C

## OVERSTRESS CAUTION

Stresses beyond those listed in Absolute Maximum Ratings may cause permanent damage to the device. Exposure to absolute maximum rating conditions for extended periods

may affect reliability. Functional operation of the device at any conditions beyond those indicated in the Recommended Operating Conditions section is not implied.

## ESD SENSITIVITY CAUTION

This integrated circuit can be damaged if ESD protections are not considered carefully. SGMICRO recommends that all integrated circuits be handled with appropriate precautions. Failure to observe proper handling and installation procedures can cause damage. ESD damage can range from subtle performance degradation to complete device failure. Precision integrated circuits may be more susceptible to damage because even small parametric changes could cause the device not to meet the published specifications.

## DISCLAIMER

SG Micro Corp reserves the right to make any change in circuit design, or specifications without prior notice.

# 1.8V, Micro-Power, Precision, RRIO, CMOS Zero-Drift SGM8606 Operational Amplifier with Comparator and Voltage Reference

## PIN CONFIGURATION

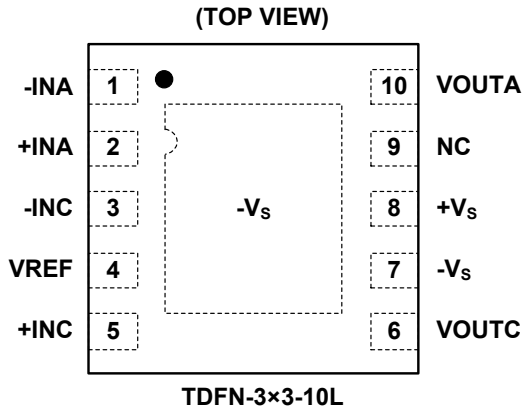

## FUNCTIONAL BLOCK DIAGRAM

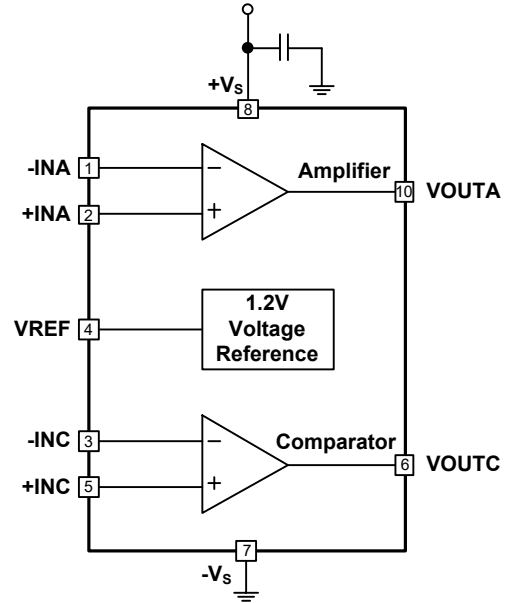

## PIN DESCRIPTION

PIN	NAME	FUNCTION
1	-INA	Negative Input of Amplifier.
2	+INA	Positive Input of Amplifier.
3	-INC	Negative Input of Comparator.
4	VREF	1.2V Voltage Reference Output.
5	+INC	Positive Input of Comparator.
6	VOUTC	Output of Comparator. Push-Pull output.
7	-Vs	Negative Supply. Always connect this pin to ground for single power supply application.
8	+Vs	Positive Power Supply.
9	NC	No Connection.
10	VOUTA	Output of Amplifier.
Exposed Pad	—	Exposed Paddle. Must be connected to -Vs or left floating.

# 1.8V, Micro-Power, Precision, RRIO, CMOS Zero-Drift SGM8606 Operational Amplifier with Comparator and Voltage Reference

## ELECTRICAL CHARACTERISTICS

PARAMETER	SYMBOL	CONDITIONS	MIN	TYP	MAX	UNITS
<b>Power Supply</b>						
Power Supply Range	$V_S$		1.8		5.5	V
Quiescent Current	$I_Q$	$I_{OUT} = 0$		20	37	$\mu A$
		$-40^\circ C \leq T_A \leq +85^\circ C$			48	

### Operational Amplifier Only

(At  $T_A = +25^\circ C$ ,  $V_S = 5V$ ,  $V_{CM} = +V_S/2$ ,  $V_{OUT} = +V_S/2$ , and  $R_L = 10k\Omega$  to  $+V_S/2$ , unless otherwise noted.)

PARAMETER	SYMBOL	CONDITIONS	MIN	TYP	MAX	UNITS
<b>Input Characteristics</b>						
Input Offset Voltage	$V_{OS}$	$V_S = 5V$		22	50	$\mu V$
		$-40^\circ C \leq T_A \leq +85^\circ C$			83	
Input Offset Voltage Drift	$\Delta V_{OS}/\Delta T$	$-40^\circ C \leq T_A \leq +85^\circ C$		0.08		$\mu V/^\circ C$
Input Bias Current	$I_B$			130		pA
Input Common Mode Voltage Range	$V_{CM}$		$(-V_S) - 0.1$		$(+V_S) + 0.1$	V
Common Mode Rejection Ratio	CMRR	$(-V_S) - 0.1V < V_{CM} < (+V_S) + 0.1V$	89	100		dB
		$-40^\circ C \leq T_A \leq +85^\circ C$	85			
Open-Loop Voltage Gain	$A_{OL}$	$(-V_S) + 0.1V < V_{OUT} < (+V_S) - 0.1V$ , $R_L = 10k\Omega$	95	121		dB
		$-40^\circ C \leq T_A \leq +85^\circ C$	94			
<b>Input Impedance</b>						
Differential				$10^9$		$\Omega$
Common Mode				$10^9$		$\Omega$
<b>Output Characteristics</b>						
Output Voltage Swing from Rail		$R_L = 10k\Omega$		14	25	mV
		$-40^\circ C \leq T_A \leq +85^\circ C$			27	
Short-Circuit Current	$I_{SC}$	$V_S = 5V$		60		mA
Open-Loop Output Impedance		$f = 350kHz$ , $I_{OUT} = 0$		1		k $\Omega$
<b>Power Supply</b>						
Specified Voltage Range	$V_S$		1.8		5.5	V
Power Supply Rejection Ratio	PSRR	$V_S = 1.8V$ to $5.5V$		4	20	$\mu V/V$
		$-40^\circ C \leq T_A \leq +85^\circ C$			25	
Turn-On Time		$V_S = 5V$		220		$\mu s$
<b>Dynamic Performance</b>						
Gain-Bandwidth Product	GBP	$C_L = 100pF$		350		kHz
Slew Rate	SR	$G = +1$		0.18		V/ $\mu s$
<b>Noise</b>						
Input Voltage Noise		$f = 0.1Hz$ to $10Hz$		2		$\mu V_{P-P}$

# 1.8V, Micro-Power, Precision, RRIO, CMOS Zero-Drift SGM8606 Operational Amplifier with Comparator and Voltage Reference

## ELECTRICAL CHARACTERISTICS (continued)

### Comparator and Voltage Reference ( $V_S = 1.8V$ )

(At  $T_A = +25^\circ C$ ,  $+V_S = 1.8V$ ,  $-V_S = 0V$ ,  $V_{CM} = +V_S/2$ , unless otherwise noted.)

PARAMETER	SYMBOL	CONDITIONS	MIN	TYP	MAX	UNITS
Input Offset Voltage	$V_{OS}$	$V_{CM} = 0V$		0.5	3	mV
		$V_{CM} = 1.8V$		0.5	3	
Input Offset Average Drift				2		$\mu V/^\circ C$
Common Mode Rejection Ratio	CMRR	$V_{CM} = 0V$ to $1.8V$	55	68		dB
Power Supply Rejection Ratio	PSRR	$V_S = 1.8V$ to $5.5V$ , $V_{CM} = 0V$	74	102		dB
Power Supply Ramp-Up Rate <sup>(1)</sup>			5			V/s
Large-Signal Voltage Gain	$A_{VO}$			100		dB
Output Swing High	$V_{OH}$	$I_{OUT} = 1mA$	1.412	1.525		V
		$I_{OUT} = 1mA$ , $-40^\circ C \leq T_A \leq +85^\circ C$	1.330			
Output Swing Low	$V_{OL}$	$I_{OUT} = -1mA$		173	249	mV
		$I_{OUT} = -1mA$ , $-40^\circ C \leq T_A \leq +85^\circ C$			347	
Output Current	$I_{OUT}$	Source	1.15	2		mA
		Source, $-40^\circ C \leq T_A \leq +85^\circ C$	1.0			
		Sink		-3.5	-2.0	
		Sink, $-40^\circ C \leq T_A \leq +85^\circ C$			-1.4	
Propagation Delay (High to Low)		Overdrive = 10mV		11.7		$\mu s$
		Overdrive = 100mV		5.6		
Propagation Delay (Low to High)		Overdrive = 10mV		24.2		$\mu s$
		Overdrive = 100mV		14.7		
Rise Time	$t_{RISE}$	Overdrive = 10mV, $C_L = 30pF$ , $R_L = 1M\Omega$		168		ns
		Overdrive = 100mV, $C_L = 30pF$ , $R_L = 1M\Omega$		174		
Fall Time	$t_{FALL}$	Overdrive = 10mV, $C_L = 30pF$ , $R_L = 1M\Omega$		75		ns
		Overdrive = 100mV, $C_L = 30pF$ , $R_L = 1M\Omega$		50		
Noise of $V_{REF}$		$f = 0.1Hz$ to $10Hz$		0.3		mV <sub>P-P</sub>
<b>Voltage Reference</b>						
Reference Voltage	$V_{REF}$	$I_{REF} = 0mA$	1.176	1.200	1.224	V
Reference Voltage Drift				42		$\mu V/^\circ C$
Reference Output Current (Source)				2		mA

NOTE: 1. If the power supply ramp-up rate is lower than 5V/s, the reference voltage output is not guaranteed to start up.

# 1.8V, Micro-Power, Precision, RRIO, CMOS Zero-Drift SGM8606 Operational Amplifier with Comparator and Voltage Reference

## ELECTRICAL CHARACTERISTICS (continued)

### Comparator and Voltage Reference ( $V_S = 5V$ )

(At  $T_A = +25^\circ C$ ,  $+V_S = 5V$ ,  $-V_S = 0V$ ,  $V_{CM} = +V_S/2$ , unless otherwise noted.)

PARAMETER	SYMBOL	CONDITIONS	MIN	TYP	MAX	UNITS
Input Offset Voltage	$V_{OS}$	$V_{CM} = 0V$		0.5	3	mV
		$V_{CM} = 5V$		0.5	3	
Input Offset Average Drift				2		$\mu V/^\circ C$
Common Mode Rejection Ratio	CMRR	$V_{CM} = 0V$ to $5V$	63	76		dB
Power Supply Rejection Ratio	PSRR	$V_S = 1.8V$ to $5.5V$ , $V_{CM} = 0V$	74	102		dB
Power Supply Ramp-Up Rate <sup>(1)</sup>			5			V/s
Large-Signal Voltage Gain	$A_{VO}$			110		dB
Output Swing High	$V_{OH}$	$I_{OUT} = 1mA$	4.874	4.904		V
		$I_{OUT} = 1mA$ , $-40^\circ C \leq T_A \leq +85^\circ C$	4.855			
Output Swing Low	$V_{OL}$	$I_{OUT} = -1mA$		106	140	mV
		$I_{OUT} = -1mA$ , $-40^\circ C \leq T_A \leq +85^\circ C$			154	
Output Current	$I_{OUT}$	Source	14.0	18		mA
		Source, $-40^\circ C \leq T_A \leq +85^\circ C$	10.5			
		Sink		-18	-15.5	
		Sink, $-40^\circ C \leq T_A \leq +85^\circ C$			-12.5	
Propagation Delay (High to Low)		Overdrive = 10mV		12.7		$\mu s$
		Overdrive = 100mV		5.6		
Propagation Delay (Low to High)		Overdrive = 10mV		38.1		$\mu s$
		Overdrive = 100mV		29.5		
Rise Time	$t_{RISE}$	Overdrive = 10mV, $C_L = 30pF$ , $R_L = 1M\Omega$		39		ns
		Overdrive = 100mV, $C_L = 30pF$ , $R_L = 1M\Omega$		40		
Fall Time	$t_{FALL}$	Overdrive = 10mV, $C_L = 30pF$ , $R_L = 1M\Omega$		33		ns
		Overdrive = 100mV, $C_L = 30pF$ , $R_L = 1M\Omega$		30		
Noise of $V_{REF}$		$f = 0.1Hz$ to $10Hz$		0.32		$mV_{P-P}$
<b>Voltage Reference</b>						
Reference Voltage	$V_{REF}$	$I_{REF} = 0mA$	1.176	1.200	1.224	V
Reference Voltage Drift				41		$\mu V/^\circ C$
Reference Output Current (Source)				2		mA

NOTE: 1. If the power supply ramp-up rate is lower than 5V/s, the reference voltage output is not guaranteed to start up.

# 1.8V, Micro-Power, Precision, RRIO, CMOS Zero-Drift SGM8606 Operational Amplifier with Comparator and Voltage Reference

## TYPICAL PERFORMANCE CHARACTERISTICS

### Operational Amplifier Only

At  $T_A = +25^\circ\text{C}$ ,  $V_S = 5\text{V}$ , and  $C_L = 0\text{pF}$ , unless otherwise noted.

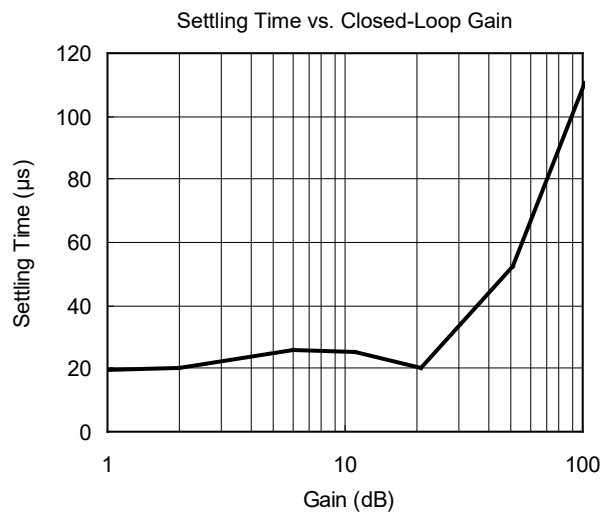
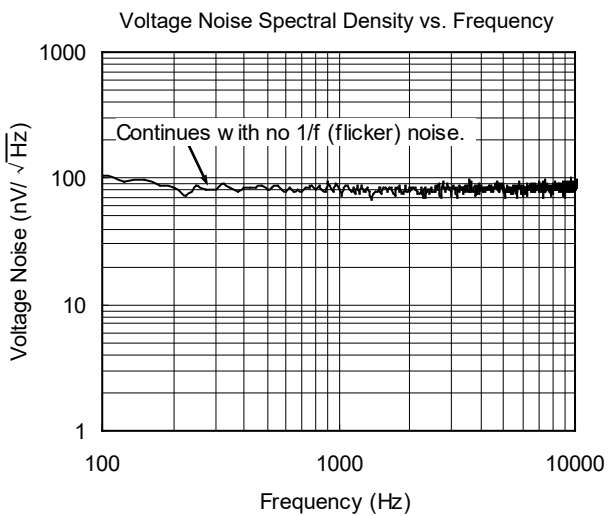
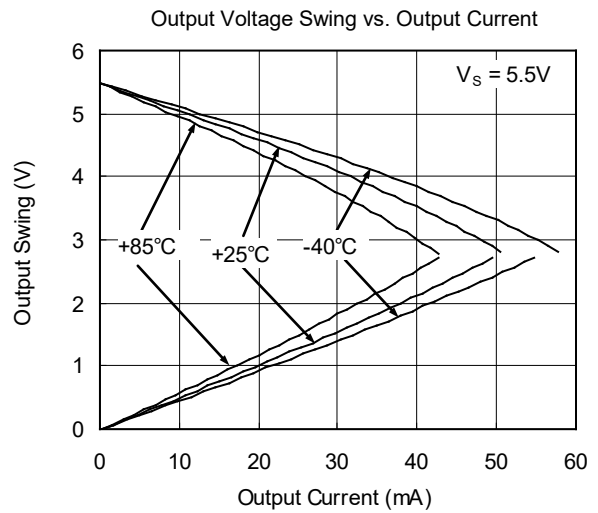
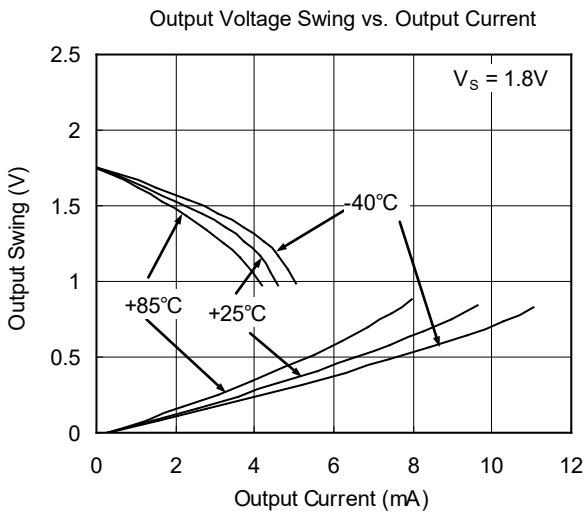
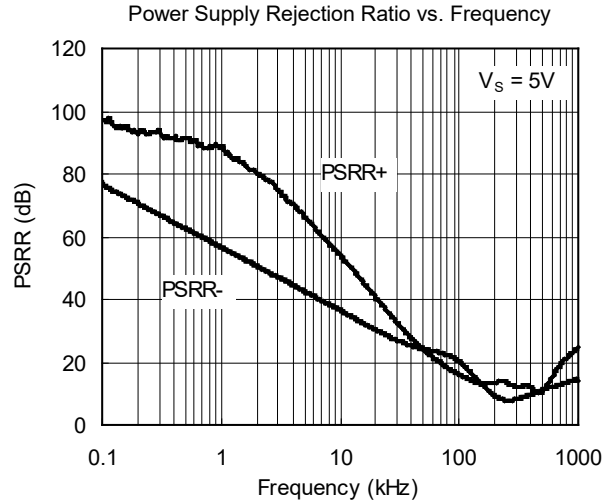
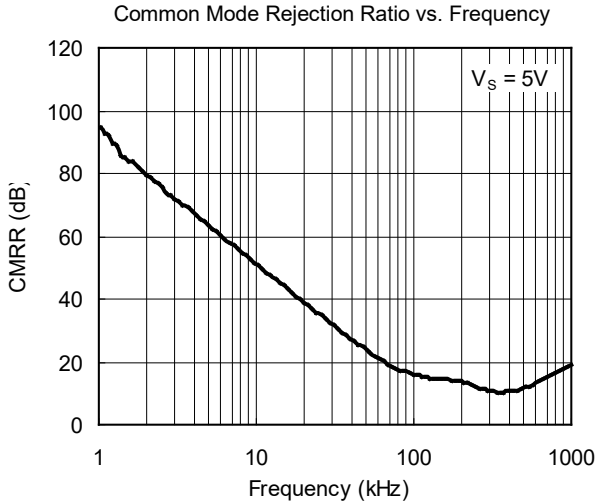

# 1.8V, Micro-Power, Precision, RRIO, CMOS Zero-Drift SGM8606 Operational Amplifier with Comparator and Voltage Reference

## TYPICAL PERFORMANCE CHARACTERISTICS (continued)

### Operational Amplifier Only (continued)

At  $T_A = +25^\circ\text{C}$ ,  $V_S = 5\text{V}$ , and  $C_L = 0\text{pF}$ , unless otherwise noted.

Large-Signal Step Response

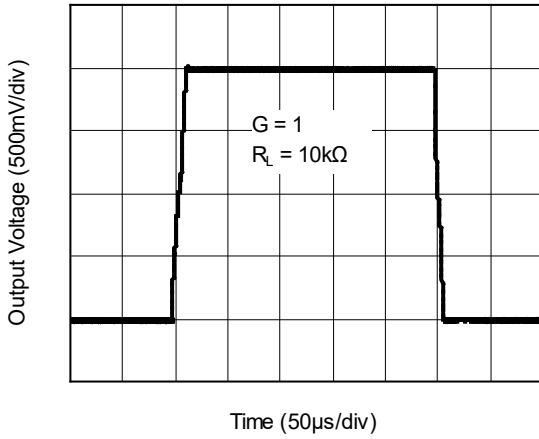

Small-Signal Step Response

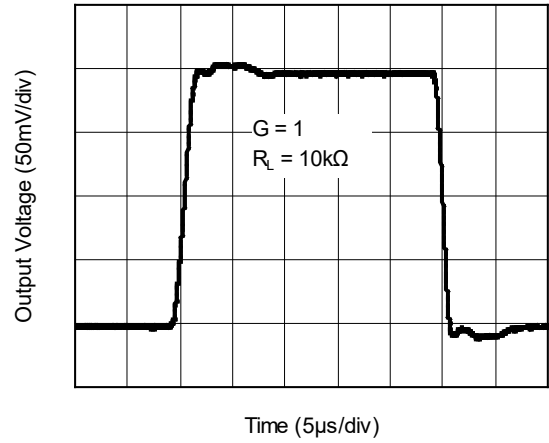

Positive Over-Voltage Recovery

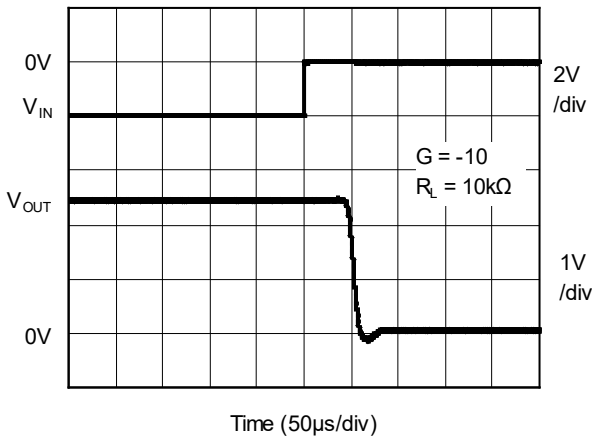

Negative Over-Voltage Recovery

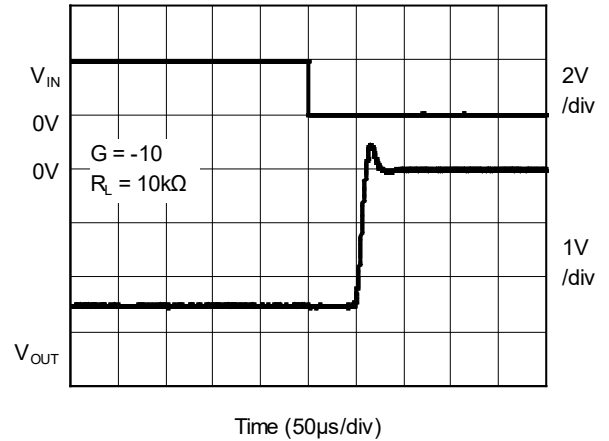

Offset Voltage Production Distribution

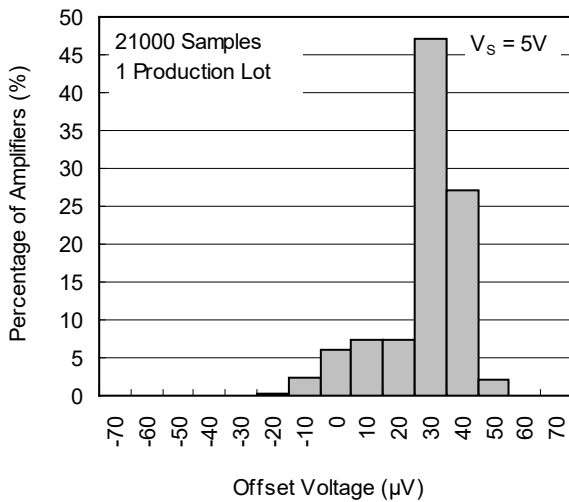

0.1Hz to 10Hz Noise

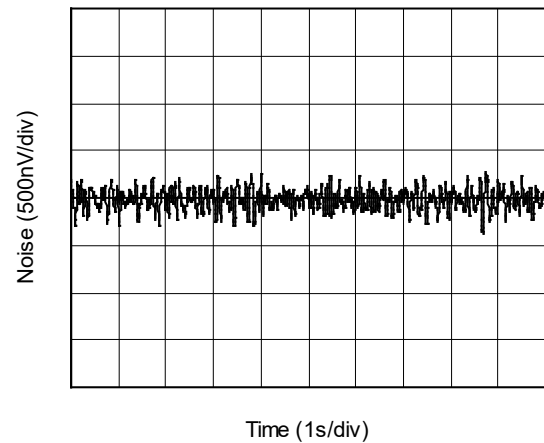



# 1.8V, Micro-Power, Precision, RRIO, CMOS Zero-Drift SGM8606 Operational Amplifier with Comparator and Voltage Reference

## TYPICAL PERFORMANCE CHARACTERISTICS (continued)

### Comparator Only

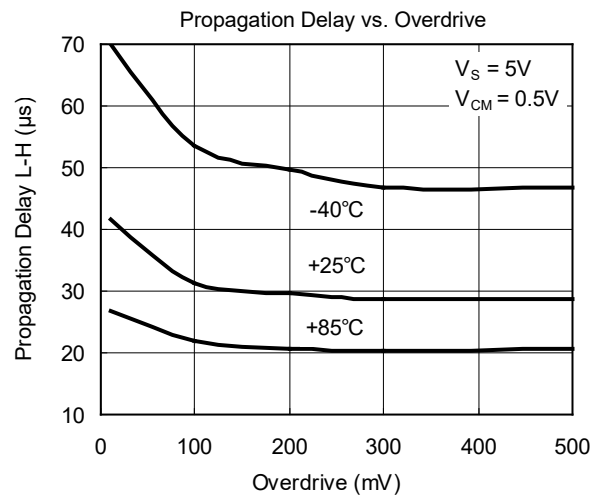
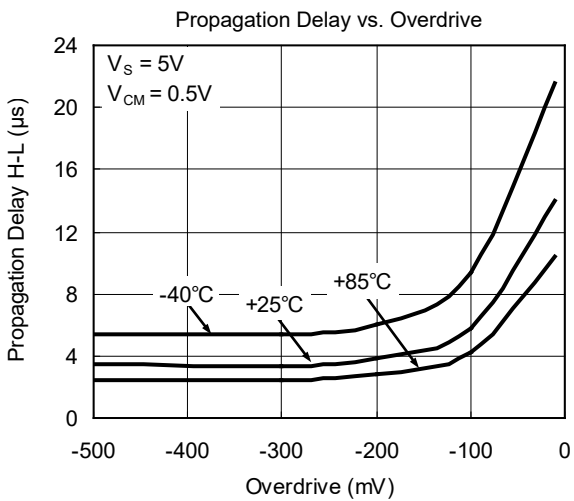
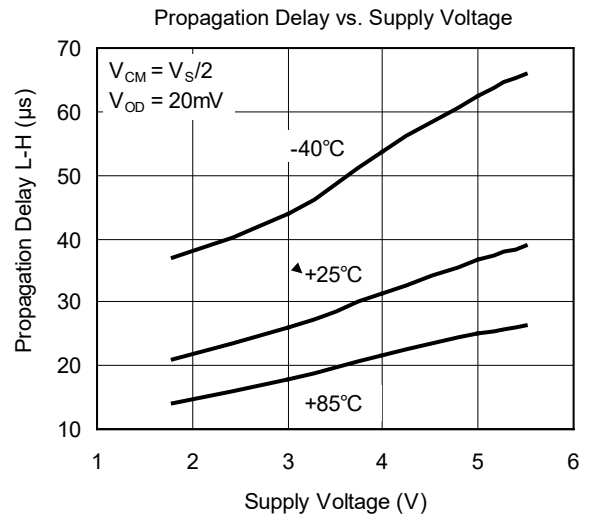
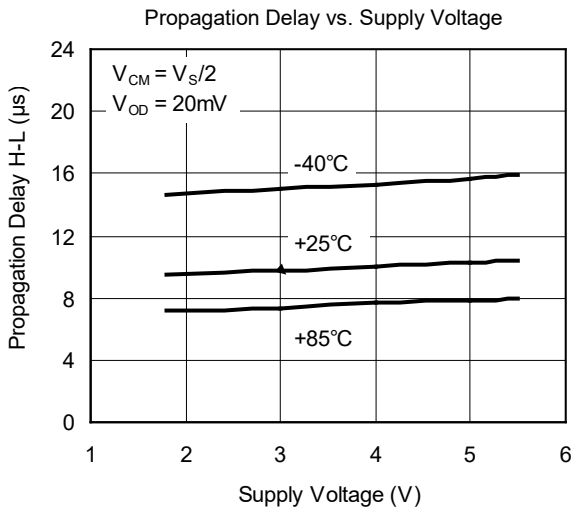
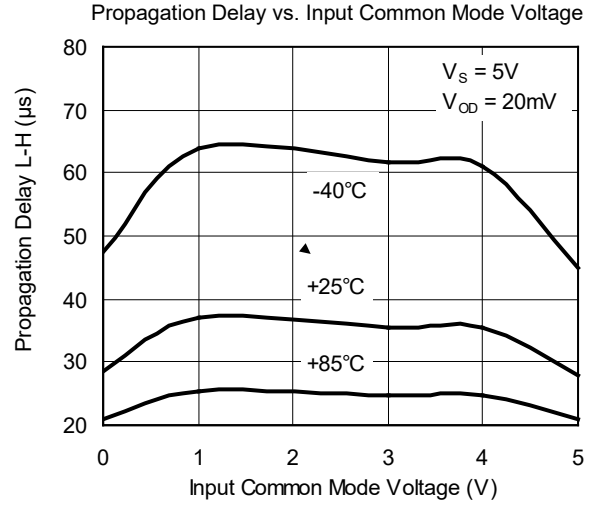
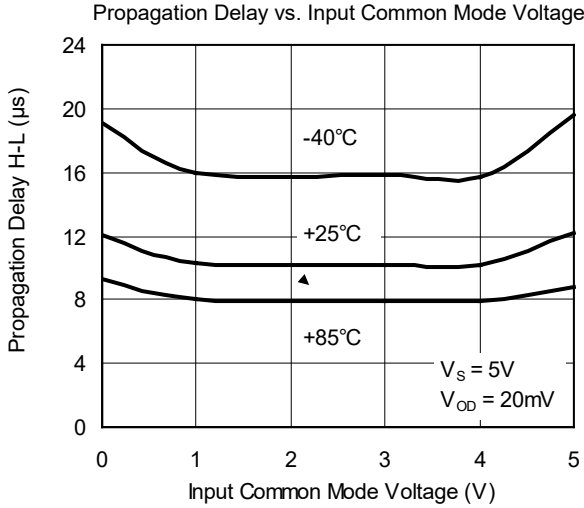

# 1.8V, Micro-Power, Precision, RRIO, CMOS Zero-Drift SGM8606 Operational Amplifier with Comparator and Voltage Reference

## TYPICAL PERFORMANCE CHARACTERISTICS (continued)

### Comparator Only (continued)

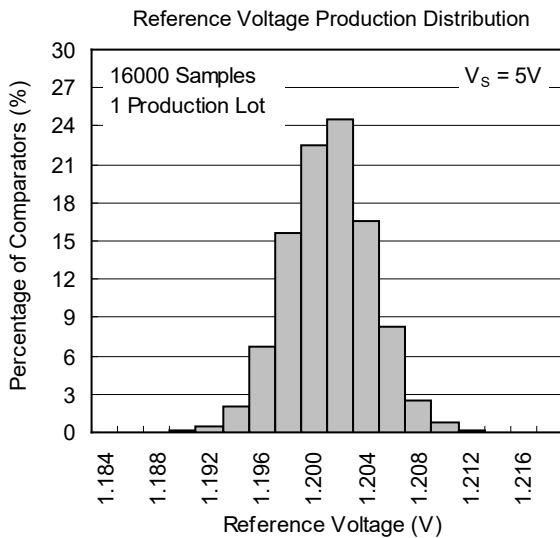
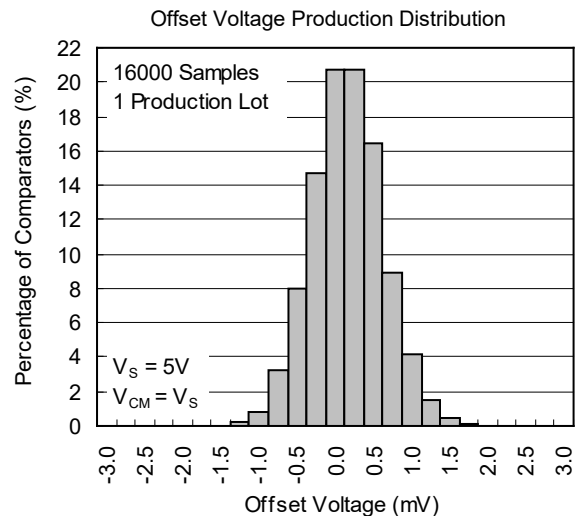
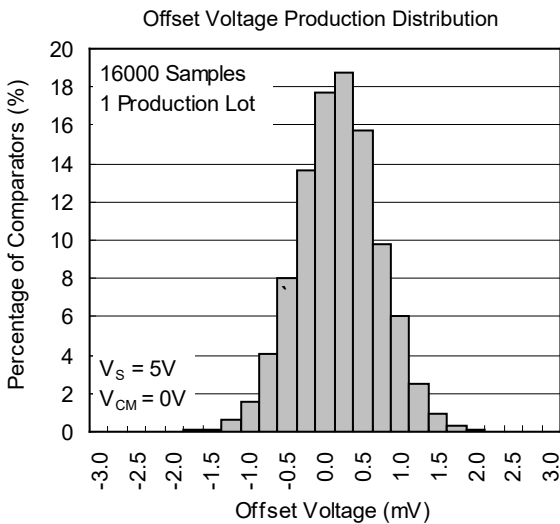
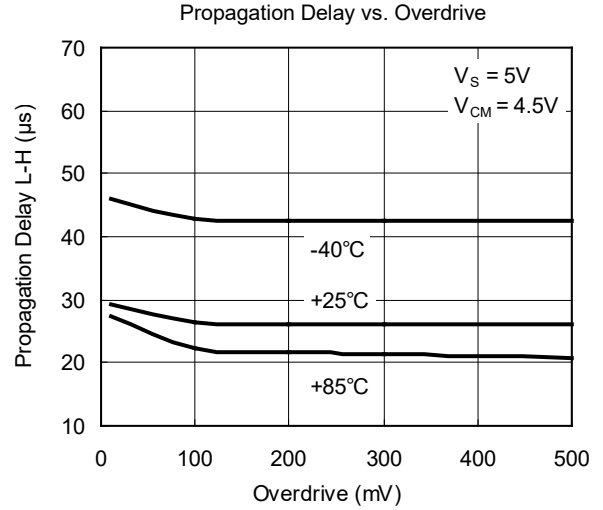
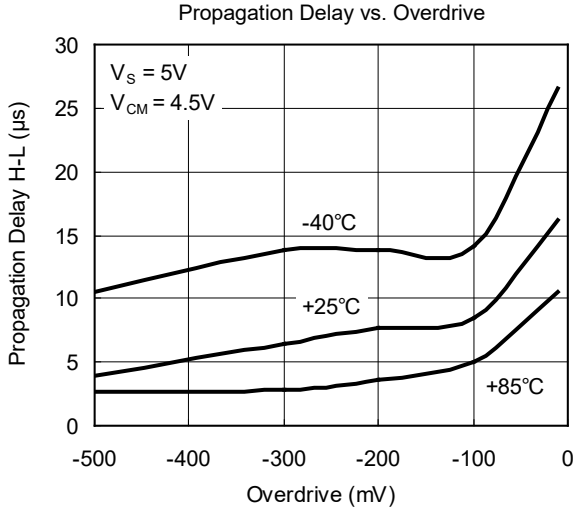

# 1.8V, Micro-Power, Precision, RRIO, CMOS Zero-Drift SGM8606 Operational Amplifier with Comparator and Voltage Reference

## TYPICAL PERFORMANCE CHARACTERISTICS (continued)

### Comparator Only (continued)

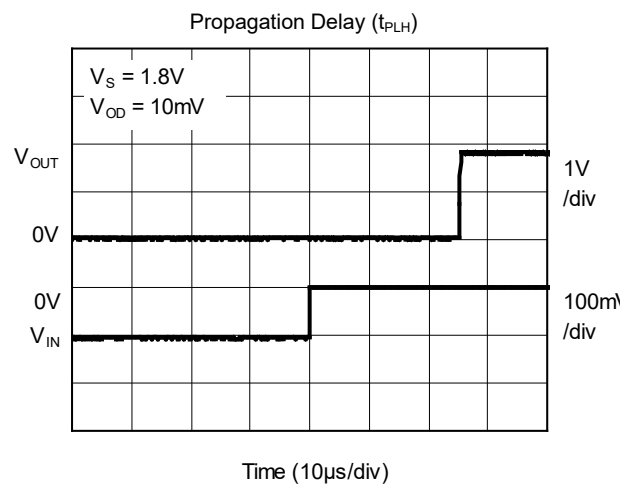
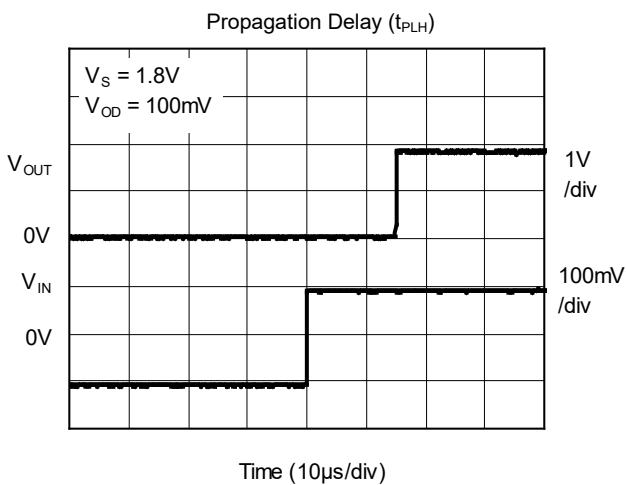
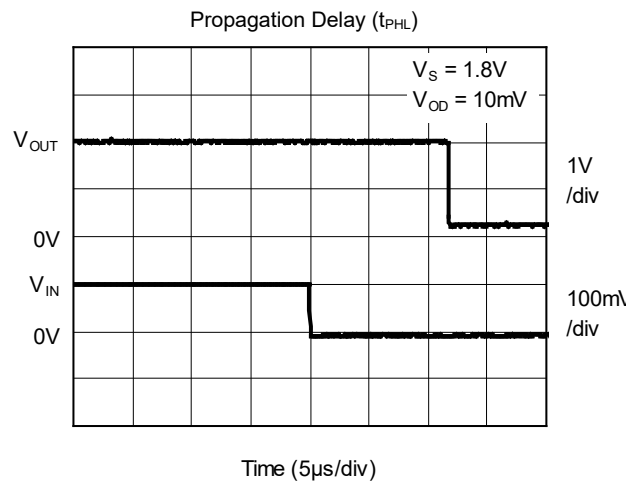
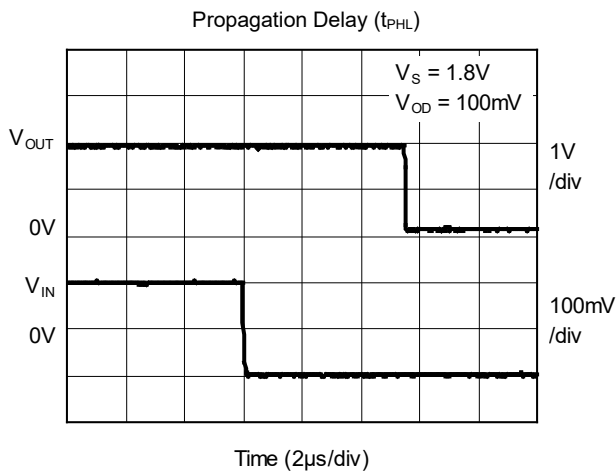
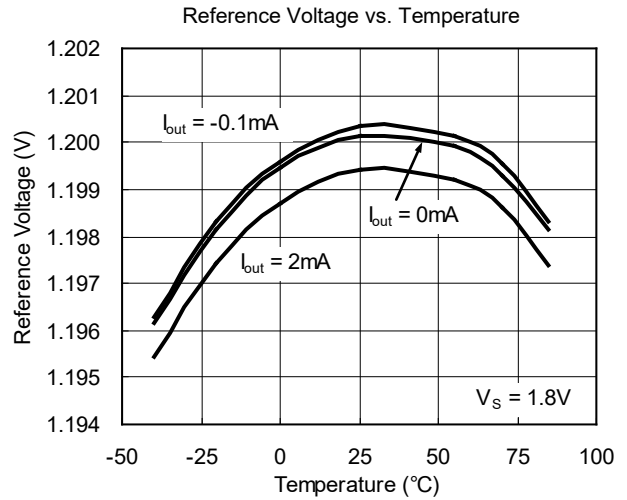
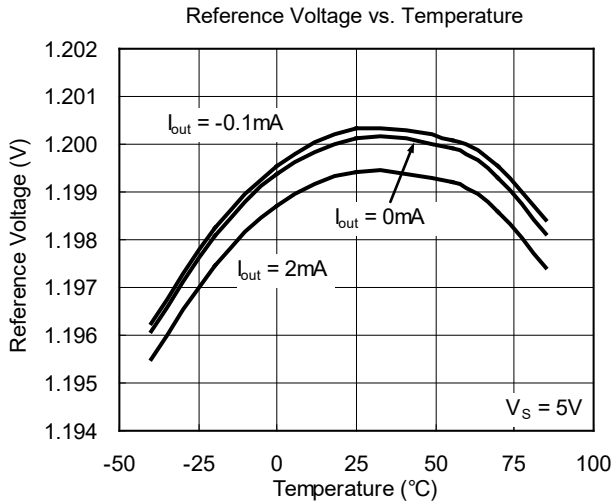

# 1.8V, Micro-Power, Precision, RRIO, CMOS Zero-Drift SGM8606 Operational Amplifier with Comparator and Voltage Reference

## TYPICAL PERFORMANCE CHARACTERISTICS (continued)

### Comparator Only (continued)

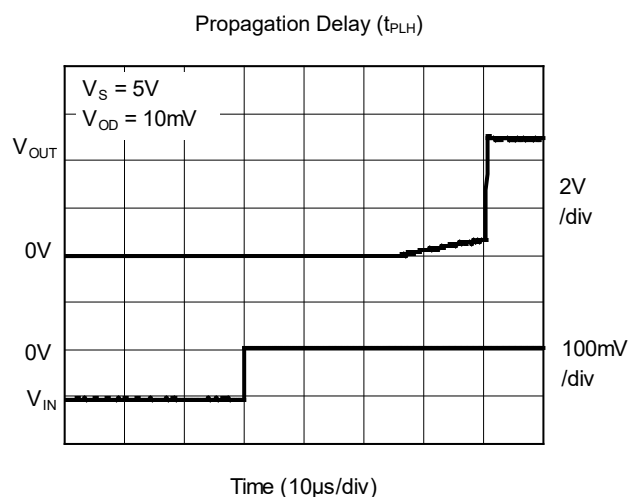
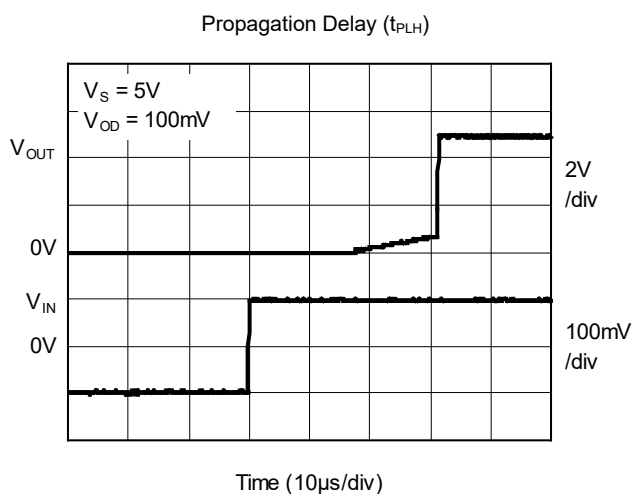
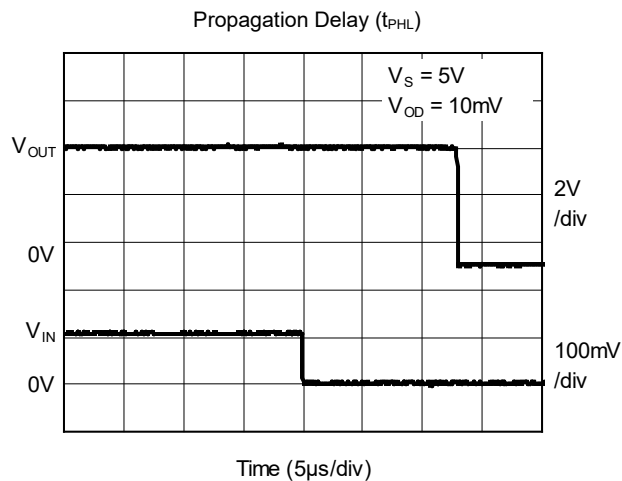
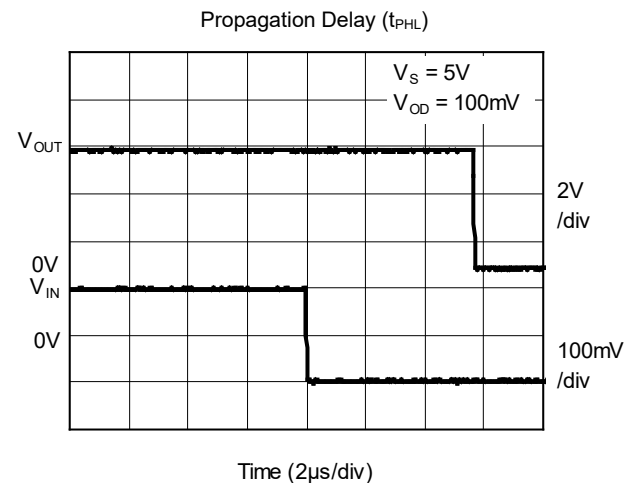

# SGM8606 1.8V, Micro-Power, Precision, RRIO, CMOS Zero-Drift Operational Amplifier with Comparator and Voltage Reference

---

## REVISION HISTORY

NOTE: Page numbers for previous revisions may differ from page numbers in the current version.

Changes from Original (DECEMBER 2015) to REV.A	Page
Changed from product preview to production data.....	All

---

PACKAGE OUTLINE DIMENSIONS

TDFN-3x3-10L

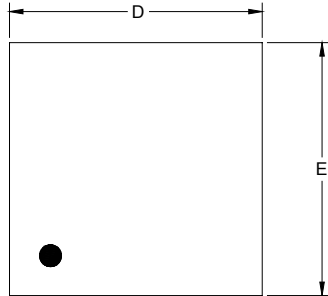

TOP VIEW

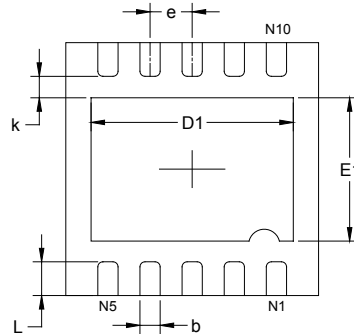

BOTTOM VIEW

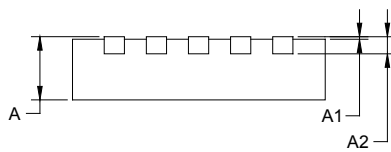

SIDE VIEW

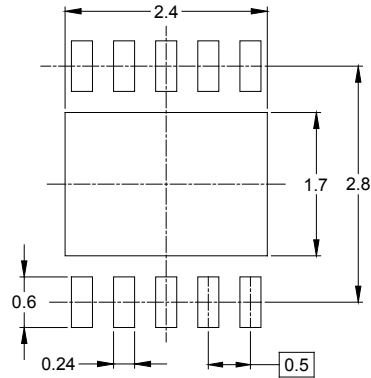

RECOMMENDED LAND PATTERN (Unit: mm)

Symbol	Dimensions In Millimeters		Dimensions In Inches	
	MIN	MAX	MIN	MAX
A	0.700	0.800	0.028	0.031
A1	0.000	0.050	0.000	0.002
A2	0.203 REF		0.008 REF	
D	2.900	3.100	0.114	0.122
D1	2.300	2.600	0.091	0.103
E	2.900	3.100	0.114	0.122
E1	1.500	1.800	0.059	0.071
k	0.200 MIN		0.008 MIN	
b	0.180	0.300	0.007	0.012
e	0.500 TYP		0.020 TYP	
L	0.300	0.500	0.012	0.020

# PACKAGE INFORMATION

## TAPE AND REEL INFORMATION

### REEL DIMENSIONS



### TAPE DIMENSIONS



NOTE: The picture is only for reference. Please make the object as the standard.

### KEY PARAMETER LIST OF TAPE AND REEL

Package Type	Reel Diameter	Reel Width W1 (mm)	A0 (mm)	B0 (mm)	K0 (mm)	P0 (mm)	P1 (mm)	P2 (mm)	W (mm)	Pin1 Quadrant
TDFN-3×3-10L	13"	12.4	3.35	3.35	1.13	4.0	8.0	2.0	12.0	Q1

000001

# PACKAGE INFORMATION

## CARTON BOX DIMENSIONS



NOTE: The picture is only for reference. Please make the object as the standard.

## KEY PARAMETER LIST OF CARTON BOX

Reel Type	Length (mm)	Width (mm)	Height (mm)	Pizza/Carton
13"	386	280	370	5

DD0002