

## Trench gate field-stop 650 V, 40 A high speed HB series IGBT

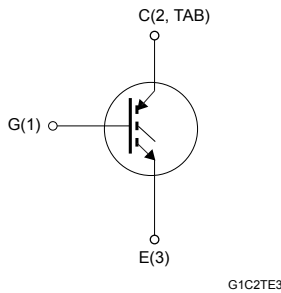
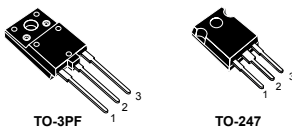

### Features

- Maximum junction temperature:  $T_J = 175\text{ }^\circ\text{C}$
- High speed switching series
- Minimized tail current
- Very low saturation voltage:  $V_{CE(sat)} = 1.6\text{ V (typ) @ } I_C = 40\text{ A}$
- Safe paralleling
- Tight parameter distribution
- Low thermal resistance

### Applications

- Welding
- Power factor correction
- UPS
- Solar inverters
- Chargers

### Description

These devices are IGBTs developed using an advanced proprietary trench gate field-stop structure. These devices are part of the new HB series of IGBTs, which represent an optimum compromise between conduction and switching loss to maximize the efficiency of any frequency converter. Furthermore, the slightly positive  $V_{CE(sat)}$  temperature coefficient and very tight parameter distribution result in safer paralleling operation.

#### Product status link

[STGFW40H65FB](#)

[STGW40H65FB](#)

[STGWA40H65FB](#)

# 1 Electrical ratings

**Table 1. Absolute maximum ratings**

Symbol	Parameter	Value		Unit
		TO-247, TO-247 long leads	TO-3PF	
V <sub>CES</sub>	Collector-emitter voltage (V <sub>GE</sub> = 0 V)	650		V
I <sub>C</sub>	Continuous collector current at T <sub>C</sub> = 25 °C	80		A
	Continuous collector current at T <sub>C</sub> = 100 °C	40		
I <sub>CP</sub> <sup>(1)</sup>	Pulsed collector current	160		A
V <sub>GE</sub>	Gate-emitter voltage	±20		V
P <sub>TOT</sub>	Total power dissipation at T <sub>C</sub> = 25 °C	283	98.6	W
V <sub>ISO</sub>	Insulation withstand voltage (RMS) from all three leads to external heat sink (t = 1 s; T <sub>C</sub> = 25 °C)		3.5	kV
T <sub>STG</sub>	Storage temperature range	-55 to 150		°C
T <sub>J</sub>	Operating junction temperature range	-55 to 175		°C

1. Pulse width is limited by maximum junction temperature.

**Table 2. Thermal data**

Symbol	Parameter	Value		Unit
		TO-247, TO-247 long leads	TO-3PF	
R <sub>thJC</sub>	Thermal resistance, junction-to-case	0.53	1.52	°C/W
R <sub>thJA</sub>	Thermal resistance, junction-to-ambient	50		°C/W

## 2 Electrical characteristics

$T_C = 25\text{ °C}$  unless otherwise specified

**Table 3. Static characteristics**

Symbol	Parameter	Test conditions	Min.	Typ.	Max.	Unit
$V_{(BR)CES}$	Collector-emitter breakdown voltage	$V_{GE} = 0\text{ V}$ , $I_C = 2\text{ mA}$	650			V
$V_{CE(sat)}$	Collector-emitter saturation voltage	$V_{GE} = 15\text{ V}$ , $I_C = 40\text{ A}$		1.6	2	V
		$V_{GE} = 15\text{ V}$ , $I_C = 40\text{ A}$ , $T_J = 125\text{ °C}$		1.7		
		$V_{GE} = 15\text{ V}$ , $I_C = 40\text{ A}$ , $T_J = 175\text{ °C}$		1.8		
$V_{GE(th)}$	Gate threshold voltage	$V_{CE} = V_{GE}$ , $I_C = 1\text{ mA}$	5	6	7	V
$I_{CES}$	Collector cut-off current	$V_{GE} = 0\text{ V}$ , $V_{CE} = 650\text{ V}$			25	$\mu\text{A}$
$I_{GES}$	Gate-emitter leakage current	$V_{CE} = 0\text{ V}$ , $V_{GE} = \pm 20\text{ V}$			$\pm 250$	nA

**Table 4. Dynamic characteristics**

Symbol	Parameter	Test conditions	Min.	Typ.	Max.	Unit
$C_{ies}$	Input capacitance	$V_{CE} = 25\text{ V}$ , $f = 1\text{ MHz}$ , $V_{GE} = 0\text{ V}$	-	5412	-	pF
$C_{oes}$	Output capacitance		-	198	-	
$C_{res}$	Reverse transfer capacitance		-	107	-	
$Q_g$	Total gate charge	$V_{CC} = 520\text{ V}$ , $I_C = 40\text{ A}$ , $V_{GE} = 0\text{ to }15\text{ V}$ (see Figure 27. Gate charge test circuit)	-	210	-	nC
$Q_{ge}$	Gate-emitter charge		-	39	-	
$Q_{gc}$	Gate-collector charge		-	82	-	

**Table 5. Switching characteristics (inductive load)**

Symbol	Parameter	Test conditions	Min.	Typ.	Max.	Unit
$t_{d(on)}$	Turn-on delay time		-	40	-	ns
$t_r$	Current rise time		-	13	-	
$(di/dt)_{on}$	Turn-on current slope		-	2413	-	A/ $\mu$ s
$t_{d(off)}$	Turn-off delay time	$V_{CE} = 400\text{ V}$ , $I_C = 40\text{ A}$ , $V_{GE} = 15\text{ V}$ , $R_G = 5\ \Omega$ (see Figure 26. Test circuit for inductive load switching)	-	142	-	ns
$t_f$	Current fall time		-	27	-	
$E_{on}^{(1)}$	Turn-on switching energy		-	498	-	$\mu$ J
$E_{off}^{(2)}$	Turn-off switching energy	-	363	-		
$E_{ts}$	Total switching energy	-	861	-		
$t_{d(on)}$	Turn-on delay time	$V_{CE} = 400\text{ V}$ , $I_C = 40\text{ A}$ , $V_{GE} = 15\text{ V}$ , $R_G = 5\ \Omega$ , $T_J = 175\text{ }^\circ\text{C}$ (see Figure 26. Test circuit for inductive load switching)	-	38	-	ns
$t_r$	Current rise time		-	14	-	
$(di/dt)_{on}$	Turn-on current slope		-	2186	-	A/ $\mu$ s
$t_{d(off)}$	Turn-off delay time		-	141	-	ns
$t_f$	Current fall time		-	61	-	
$E_{on}^{(1)}$	Turn-on switching energy		-	1417	-	$\mu$ J
$E_{off}^{(2)}$	Turn-off switching energy		-	764	-	
$E_{ts}$	Total switching energy	-	2181	-		

1. Including the reverse recovery of the external diode. The diode is the same of the co-packed STGW40H65DFB.

2. Including the tail of the collector current.

## 2.1 Electrical characteristics (curves)

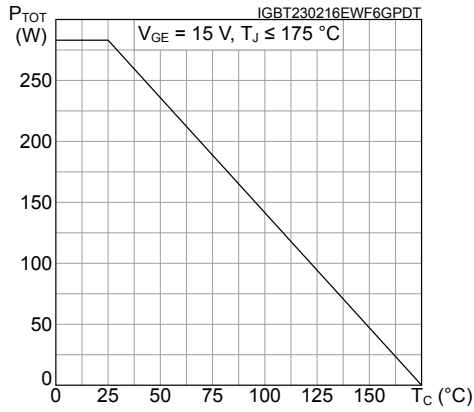
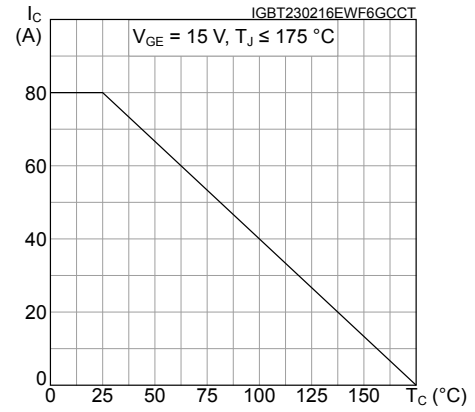
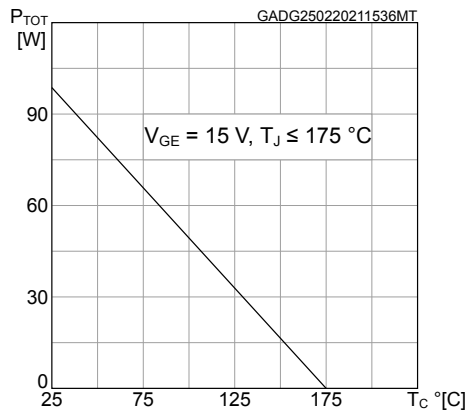
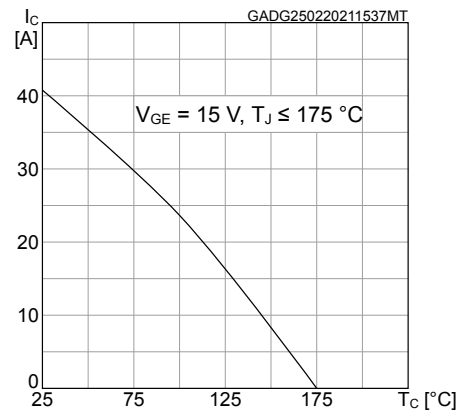
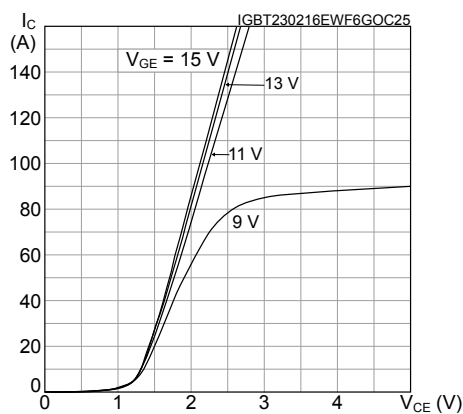
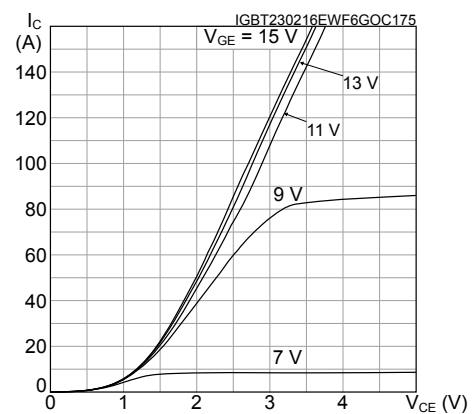
**Figure 1. Power dissipation vs. case temperature for TO-247 and TO-247 long leads**

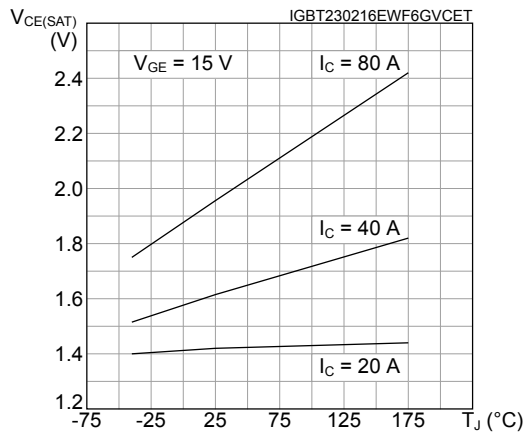
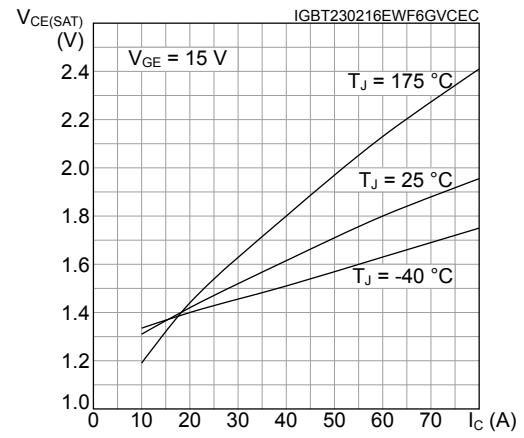
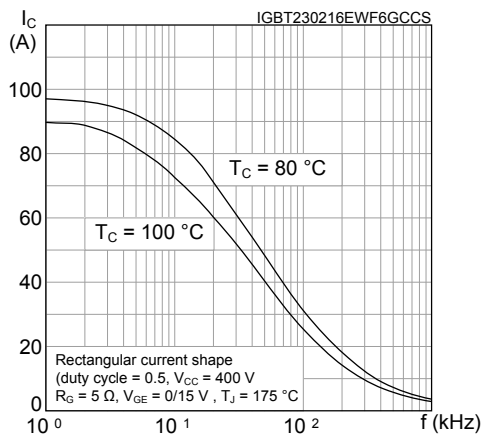
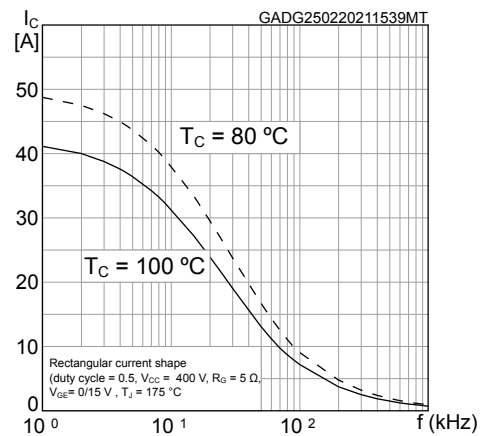
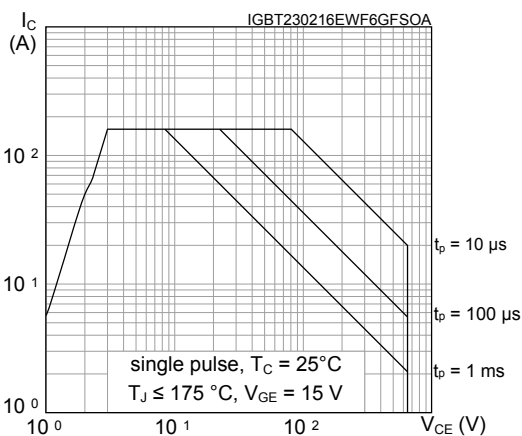
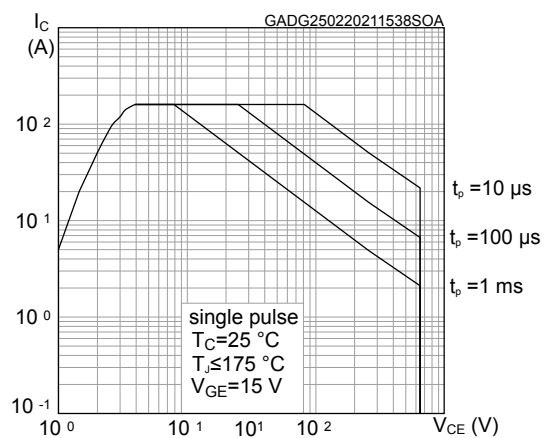
**Figure 2. Collector current vs. case temperature for TO-247 and TO-247 long leads**

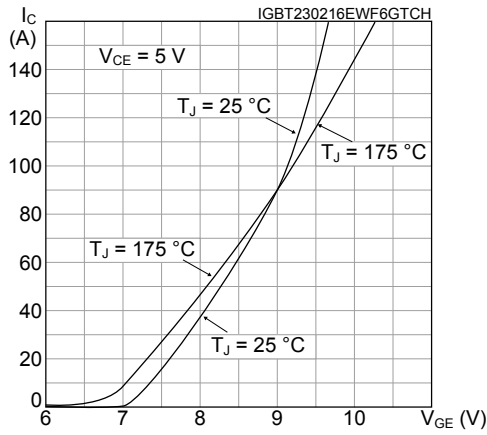
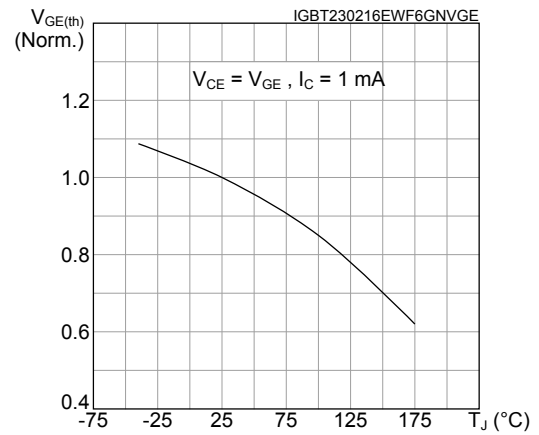
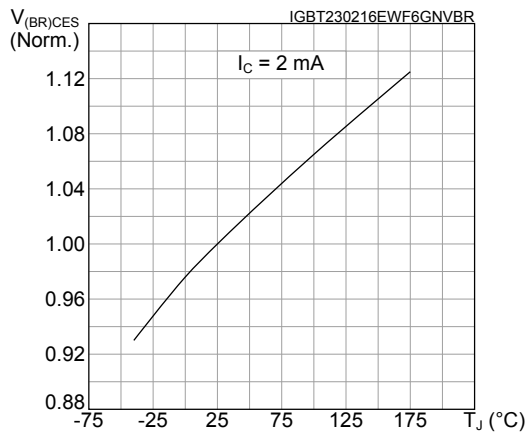
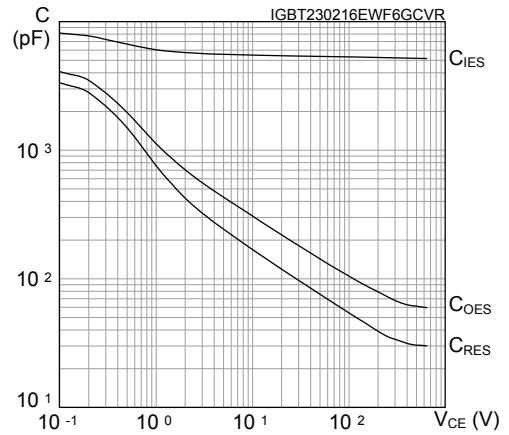
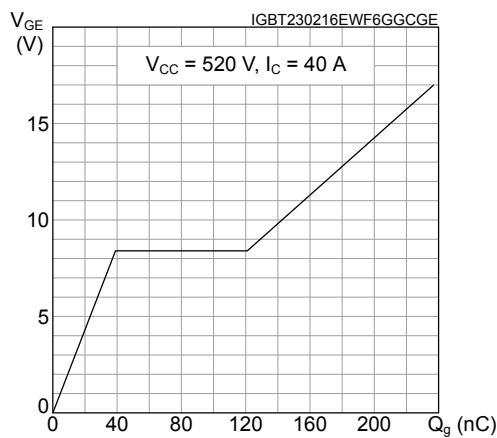
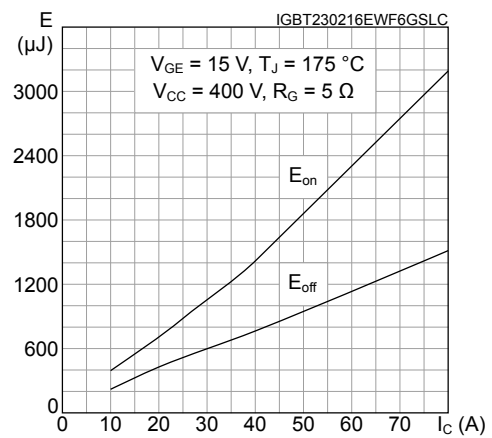
**Figure 3. Power dissipation vs. case temperature for TO-3PF**

**Figure 4. Collector current vs. case temperature for TO-3PF**

**Figure 5. Output characteristics (T<sub>J</sub> = 25 °C)**

**Figure 6. Output characteristics (T<sub>J</sub> = 175 °C)**

**Figure 7.  $V_{CE(sat)}$  vs. junction temperature**

**Figure 8.  $V_{CE(sat)}$  vs. collector current**

**Figure 9. Collector current vs. switching frequency for TO-247 and TO-247 long leads**

**Figure 10. Collector current vs. switching frequency for TO-3PF**

**Figure 11. Forward bias safe operating area for TO-247 and TO-247 long leads**

**Figure 12. Forward bias safe operating area for TO-3PF**

**Figure 13. Transfer characteristics**

**Figure 14. Normalized  $V_{GE(th)}$  vs. junction temperature**

**Figure 15. Normalized  $V_{(BR)CES}$  vs. junction temperature**

**Figure 16. Capacitance variation**

**Figure 17. Gate charge vs. gate-emitter voltage**

**Figure 18. Switching energy vs. collector current**

**Figure 19. Switching energy vs. gate resistance**

**Figure 20. Switching energy vs. temperature**

**Figure 21. Switching energy vs. collector emitter voltage**

**Figure 22. Switching times vs. collector current**

**Figure 23. Switching times vs. gate resistance**

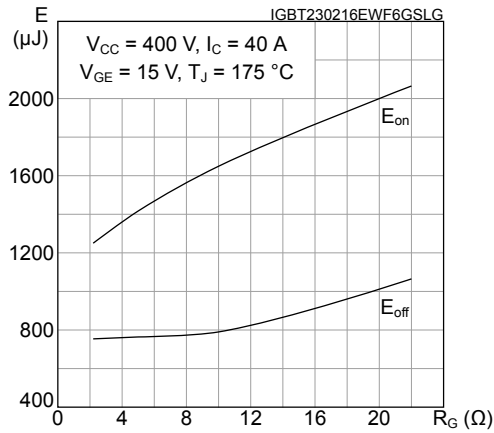
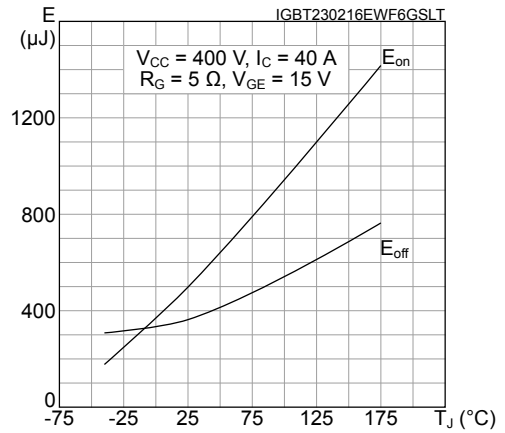
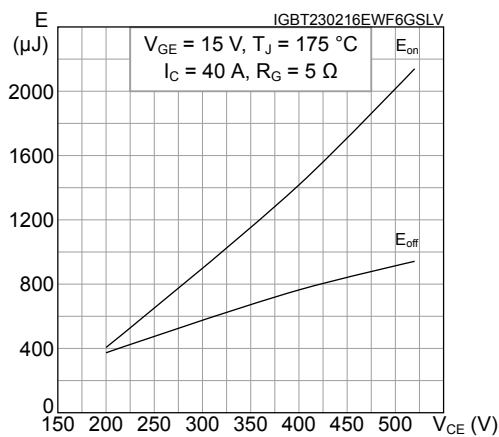
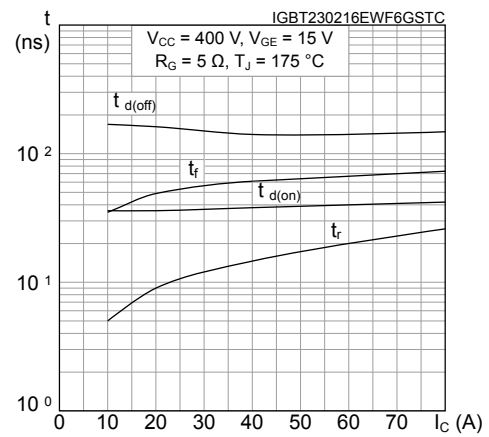
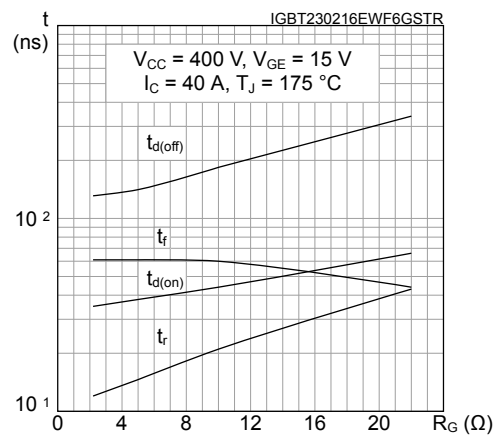

Figure 24. Thermal impedance for TO-247 and TO-247 long leads

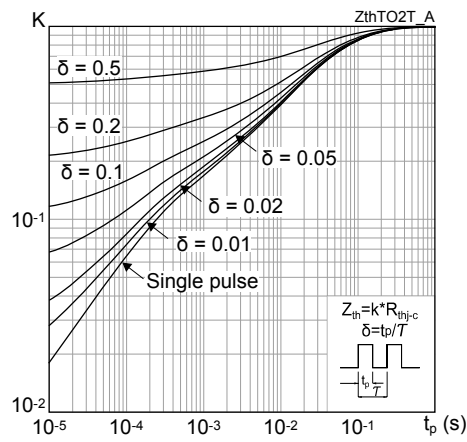
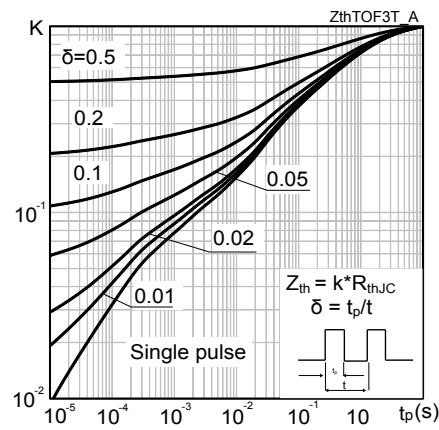

Figure 25. Thermal impedance for TO-3PF





## 4 Package information

In order to meet environmental requirements, ST offers these devices in different grades of **ECOPACK** packages, depending on their level of environmental compliance. ECOPACK specifications, grade definitions and product status are available at: [www.st.com](http://www.st.com). ECOPACK is an ST trademark.

### 4.1 TO-3PF package information

Figure 29. TO-3PF package outline

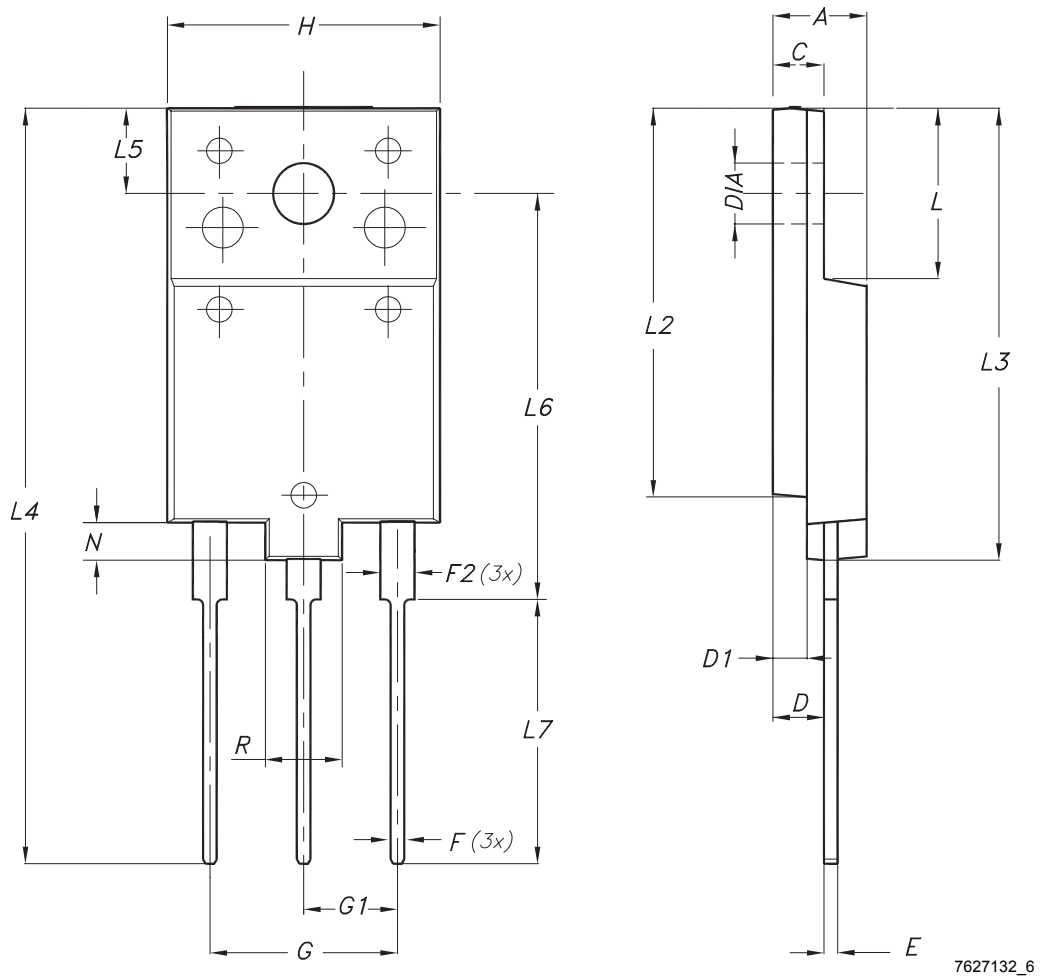

7627132\_6

**Table 6. TO-3PF mechanical data**

Dim.	mm		
	Min.	Typ.	Max.
A	5.30		5.70
C	2.80		3.20
D	3.10		3.50
D1	1.80		2.20
E	0.80		1.10
F	0.65		0.95
F2	1.80		2.20
G	10.30		11.50
G1		5.45	
H	15.30		15.70
L	9.80	10.00	10.20
L2	22.80		23.20
L3	26.30		26.70
L4	43.20		44.40
L5	4.30		4.70
L6	24.30		24.70
L7	14.60		15.00
N	1.80		2.20
R	3.80		4.20
Dia	3.40		3.80

## 4.2 TO-247 package information

Figure 30. TO-247 package outline

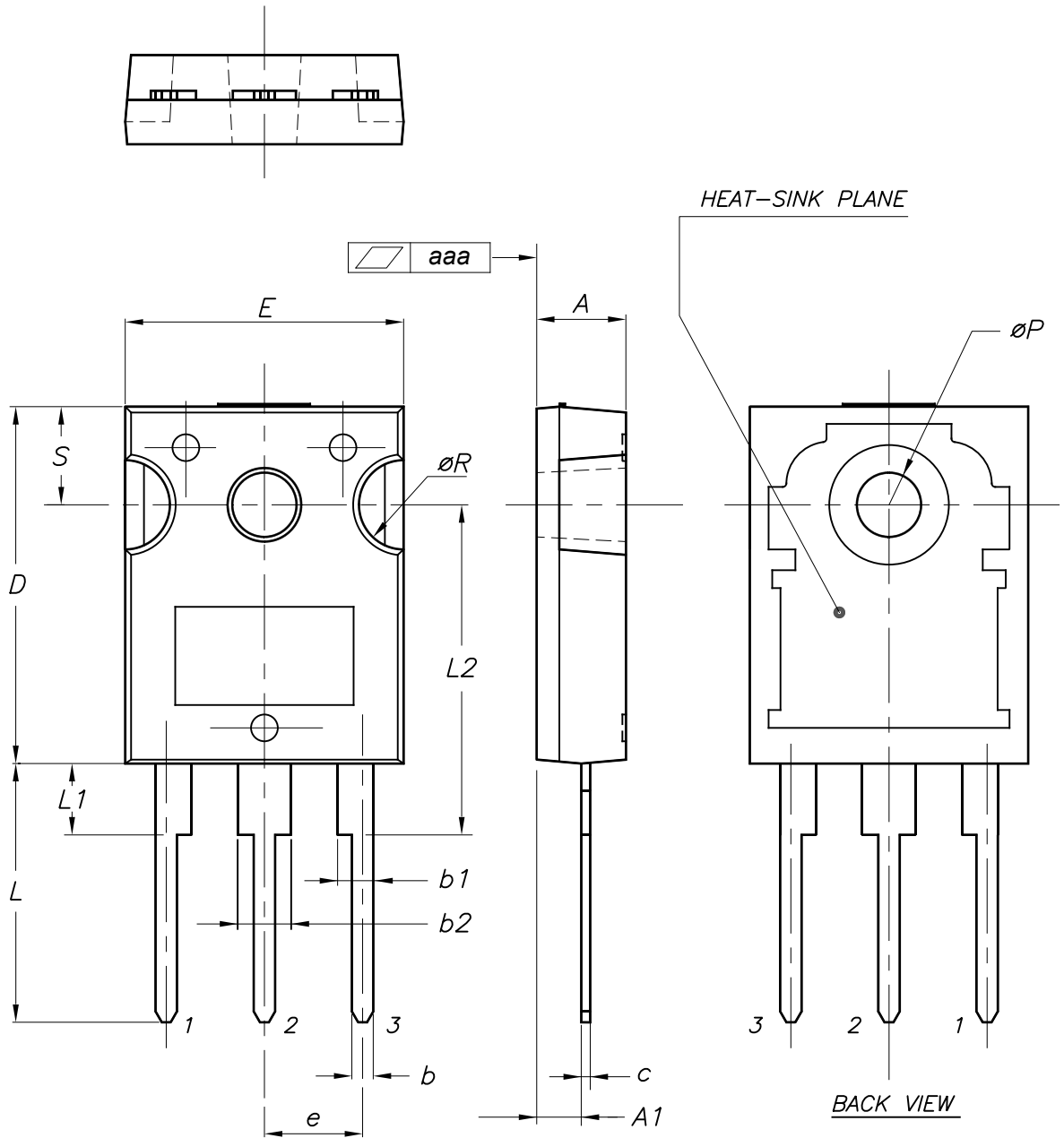

0075325\_10

**Table 7. TO-247 package mechanical data**

Dim.	mm		
	Min.	Typ.	Max.
A	4.85		5.15
A1	2.20		2.60
b	1.0		1.40
b1	2.0		2.40
b2	3.0		3.40
c	0.40		0.80
D	19.85		20.15
E	15.45		15.75
e	5.30	5.45	5.60
L	14.20		14.80
L1	3.70		4.30
L2		18.50	
ØP	3.55		3.65
ØR	4.50		5.50
S	5.30	5.50	5.70
aaa		0.04	0.10

### 4.3 TO-247 long leads package information

Figure 31. TO-247 long leads package outline

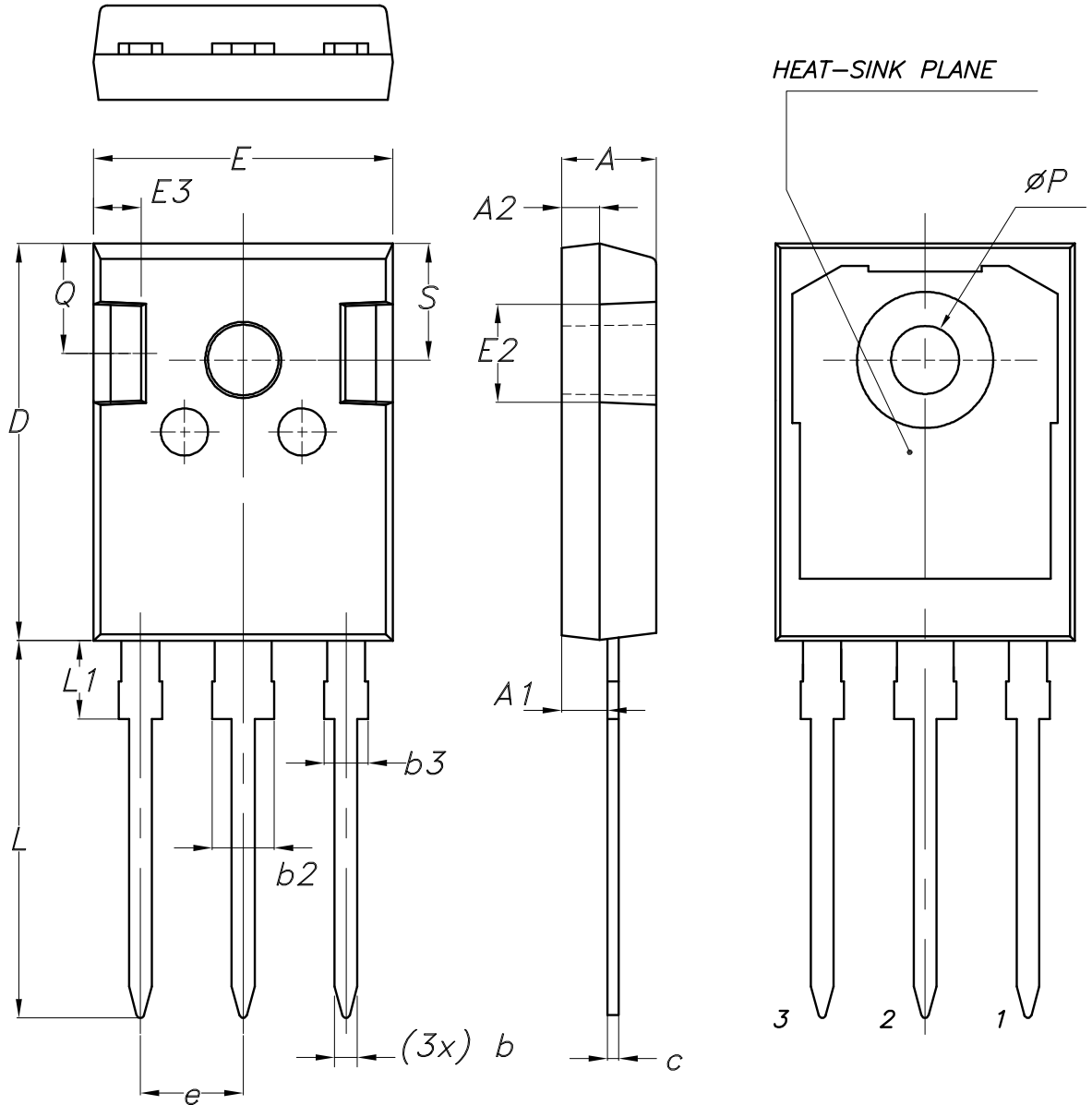

8463846\_2\_F

**Table 8. TO-247 long leads package mechanical data**

Dim.	mm		
	Min.	Typ.	Max.
A	4.90	5.00	5.10
A1	2.31	2.41	2.51
A2	1.90	2.00	2.10
b	1.16		1.26
b2			3.25
b3			2.25
c	0.59		0.66
D	20.90	21.00	21.10
E	15.70	15.80	15.90
E2	4.90	5.00	5.10
E3	2.40	2.50	2.60
e	5.34	5.44	5.54
L	19.80	19.92	20.10
L1			4.30
P	3.50	3.60	3.70
Q	5.60		6.00
S	6.05	6.15	6.25





## 5 Ordering information

Table 9. Order codes

Order code	Marking	Package	Packing
STGFW40H65FB	GFW40H65FB	TO-3PF	Tube
STGW40H65FB	GW40H65FB	TO-247	
STGWA40H65FB	GWA40H65FB	TO-247 long leads	

## Revision history

**Table 10. Document revision history**

Date	Revision	Changes
30-Aug-2013	1	Initial release
11-Sep-2013	2	Document status changed from preliminary to production data. Inserted <i>Section 2.1: Electrical characteristics (curves)</i> .
28-Feb-2014	3	Updated title and description in cover page.
05-Mar-2014	4	Updated units in <i>Table 6: Switching characteristics (inductive load)</i> .
11-Apr-2014	5	Added part number and references for the device in a TO-3PF package.
03-Nov-2016	6	Added device in TO-247 long leads and updated the document accordingly. Updated <i>Section 2.1: Electrical characteristics (curves)</i> and <i>Section 4.3: TO-247 long leads, package information</i> . Minor text changes.
21-Mar-2017	7	Updated <i>Table 1: "Device summary"</i> . Added <i>Figure 26: "Thermal impedance for TO-3PF"</i> . Minor text changes
09-Mar-2021	8	The part number STGWT40H65FB has been removed and the document has been updated accordingly. Updated title in cover page. Updated <i>Section 1 Electrical ratings</i> and <i>Section 2.1 Electrical characteristics (curves)</i> . Minor text changes



---

## Contents

<b>1</b>	<b>Electrical ratings</b> .....	<b>2</b>
<b>2</b>	<b>Electrical characteristics</b> .....	<b>3</b>
<b>2.1</b>	Electrical characteristics (curves) .....	<b>5</b>
<b>3</b>	<b>Test circuits</b> .....	<b>10</b>
<b>4</b>	<b>Package information</b> .....	<b>11</b>
<b>4.1</b>	TO-3PF package information .....	11
<b>4.2</b>	TO-247 package information .....	13
<b>4.3</b>	TO-247 long leads package information .....	15
<b>5</b>	<b>Ordering information</b> .....	<b>17</b>
	<b>Revision history</b> .....	<b>18</b>
	<b>Contents</b> .....	<b>19</b>



**IMPORTANT NOTICE – PLEASE READ CAREFULLY**

STMicroelectronics NV and its subsidiaries (“ST”) reserve the right to make changes, corrections, enhancements, modifications, and improvements to ST products and/or to this document at any time without notice. Purchasers should obtain the latest relevant information on ST products before placing orders. ST products are sold pursuant to ST’s terms and conditions of sale in place at the time of order acknowledgement.

Purchasers are solely responsible for the choice, selection, and use of ST products and ST assumes no liability for application assistance or the design of Purchasers’ products.

No license, express or implied, to any intellectual property right is granted by ST herein.

Resale of ST products with provisions different from the information set forth herein shall void any warranty granted by ST for such product.

ST and the ST logo are trademarks of ST. For additional information about ST trademarks, please refer to [www.st.com/trademarks](http://www.st.com/trademarks). All other product or service names are the property of their respective owners.

Information in this document supersedes and replaces information previously supplied in any prior versions of this document.

© 2021 STMicroelectronics – All rights reserved