

## SUPER LOW OPERATING CURRENT AND LOW OFFSET VOLTAGE TINY SINGLE CMOS COMPARATOR

### ■ GENERAL DESCRIPTION

The NJU7116 is a super low operating current and low offset voltage tiny single CMOS comparator with CMOS output.

The operating current is  $1\mu\text{A}$  ( typ ), and the operating of 1.8V to 3.6V.

The input offset voltage is lower than 2.5mV ( max ).

Furthermore, the NJU7116 is packaged with very small SOT-23-5 DFN6-G1; therefore it can be especially applied to battery operated portable items.

### ■ PACKAGE OUTLINE

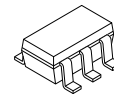

NJU7116F



NJU7116KG1

### ■ FEATURES

- Super Low Operating Current ( $I_{DD}=1.0\mu\text{A}$  typ. )
- Single Power Supply ( $V_{DD}=1.8$  to  $3.6\text{V}$ )
- Low Offset Voltage ( $V_{IO}=2.5\text{mV}$  max.@  $3.0\text{V}$ )
- Low Bias Current ( $I_B=1\text{pA}$  typ. )
- CMOS ( Push-pull ) Output
- Package Outline SOT-23-5, DFN6-G1
- CMOS Technology

### ■ PIN CONFIGURATION

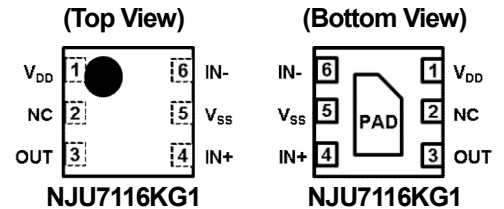
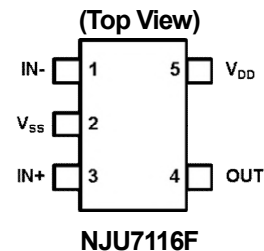

The NC pin and the PAD should connect with a VSS terminal.

### ■ EQUIVALENT CIRCUIT

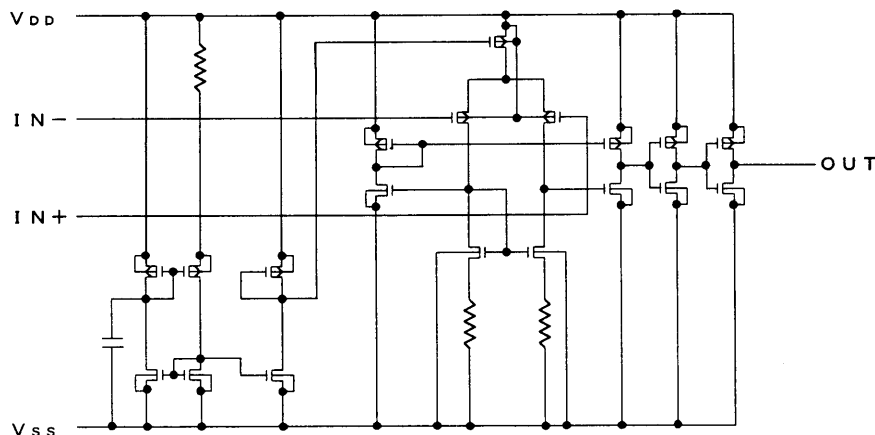

# NJU7116

## ■ ABSOLUTE MAXIMUM RATINGS

( Ta=25°C )

PARAMETER	SYMBOL	RATINGS	UNIT
Supply Voltage	V <sub>DD</sub>	7	V
Differential Input Voltage	V <sub>ID</sub>	± 7 (note1)	V
Common Mode Input Voltage	V <sub>IC</sub>	-0.3 to 7( note1)	V
Power Dissipation	P <sub>D</sub>	390 (note 3) / 520 (note 4) 260 (note 5) / 950 (note 6)	mW
Operating Temperature Range	T <sub>opr</sub>	-40 to +105	°C
Storage Temperature Range	T <sub>stg</sub>	-55 to +125	°C

( note1) For supply voltage less than 7V, the absolute maximum rating is equal to the supply voltage.

( note2 ) Decoupling capacitor should be connected between V<sub>DD</sub> and V<sub>SS</sub> due to the stabilized operation for the circuit.

( note3 ) EIA/JEDEC STANDARD Test board (76.2x114.3x1.6mm, 2layers, FR-4) mounting

( note4 ) EIA/JEDEC STANDARD Test board (76.2x114.3x1.6mm, 4layers, FR-4) mounting

( note5 ) Mounted on glass epoxy board. (101.5×114.5×1.6mm: based on EIA/JEDEC standard, 2Layers FR-4, with Exposed Pad)

( note6 ) Mounted on glass epoxy board. (101.5×114.5×1.6mm: based on EIA/JEDEC standard, 4Layers FR-4, with Exposed Pad)

(For 4Layers: Applying 99.5×99.5mm inner Cu area and a thermal via hole to a board based on JEDEC standard JESD51-5)

( note7 ) The NC pin and the PAD should connect with a VSS terminal.

( note8 ) The NC pin is electrically not connected to the die in a package.

( note9 ) The PAD is electrically connected to the backside of the die. The PAD cannot be used as VSS terminal.

## ■ ELECTRICAL CHARACTERISTICS

( Ta=25°C, V<sub>DD</sub>=3.0V, R<sub>L</sub>=∞ )

PARAMETER	SYMBOL	TEST CONDITION	MIN.	TYP.	MAX.	UNIT
Operating Voltage	V <sub>DD</sub>		1.8	-	3.6	V
Input Offset Voltage	V <sub>IO</sub>	V <sub>IN</sub> =1/2V <sub>DD</sub>	-	-	2.5	mV
Input Offset Current	I <sub>IO</sub>		-	1	-	pA
Input Bias Current	I <sub>IB</sub>		-	1	-	pA
Input Common Mode Voltage Range	V <sub>ICM</sub>		0~2.5	-	-	V
High Level Output Voltage	V <sub>OH</sub>	I <sub>OH</sub> =2mA	2.7	-	-	V
Low Level Output Voltage	V <sub>OL</sub>	I <sub>OL</sub> =-2mA	-	-	0.3	V
Common Mode Rejection Ratio	CMR	V <sub>IC</sub> =1/2V <sub>DD</sub>	50	-	-	dB
Supply Voltage Rejection Ratio	SVR	V <sub>DD</sub> =1.8~3.6V	50	-	-	dB
Operating Current	I <sub>DD</sub>	No Load, V <sub>O</sub> =0V	-	1	1.5	μA

## ■ SWITCHING CHARACTERISTICS

( Ta=25°C, V<sub>DD</sub>=3.0V, f=1kHz, C<sub>L</sub>=15pF )

PARAMETER	SYMBOL	CONDITIONS	MIN	TYP	MAX	UNIT
Propagation Delay High to Low	t <sub>PHL</sub>	Over Drive=100mV	-	1.2	2.0	μs
		TTL Level Step In.	-	0.37	-	
Propagation Delay Low to High	t <sub>PLH</sub>	Over Drive=100mV	-	3.3	5.0	μs
		TTL Level Step In.	-	2.6	-	
Propagation Delay Time Lag	t <sub>PD</sub>	t <sub>PLH</sub> - t <sub>PHL</sub>	-	2.1	3.0	μs
Output Signal Falling Time	t <sub>THL</sub>	Over Drive=100mV	-	15	-	ns
Output Signal Rising Time	t <sub>TLH</sub>	Over Drive=100mV	-	40	-	ns

## TYPICAL CHARACTERISTICS

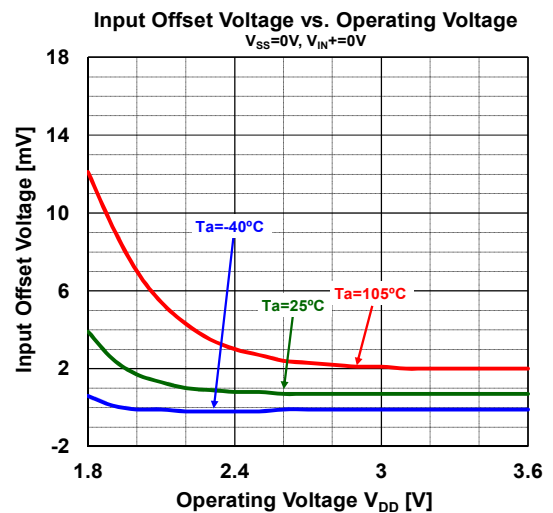
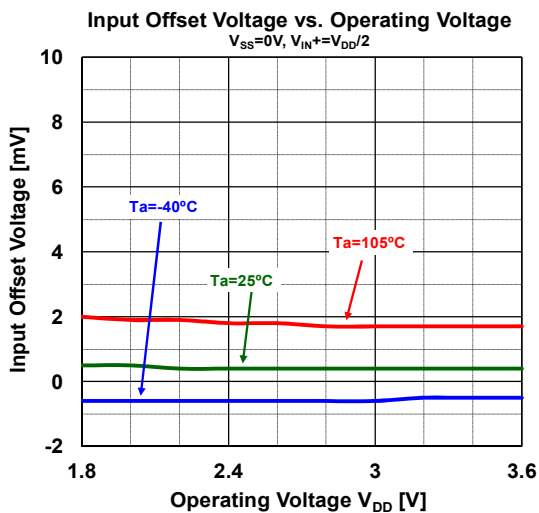
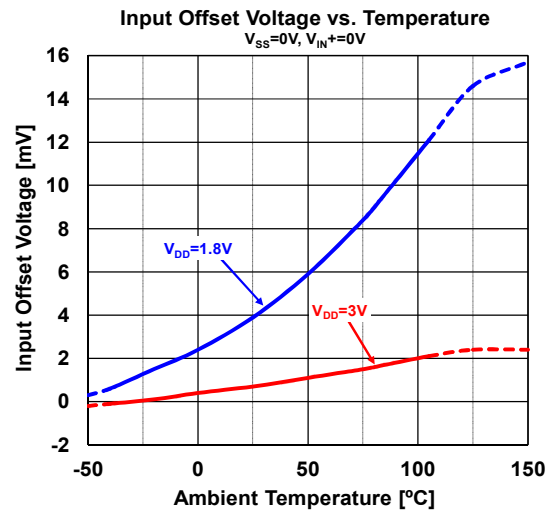
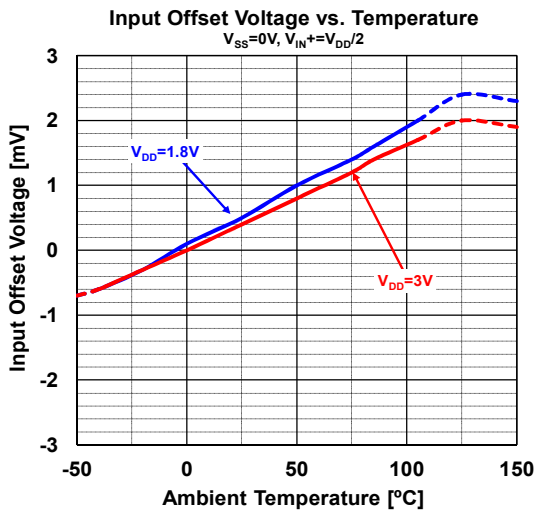
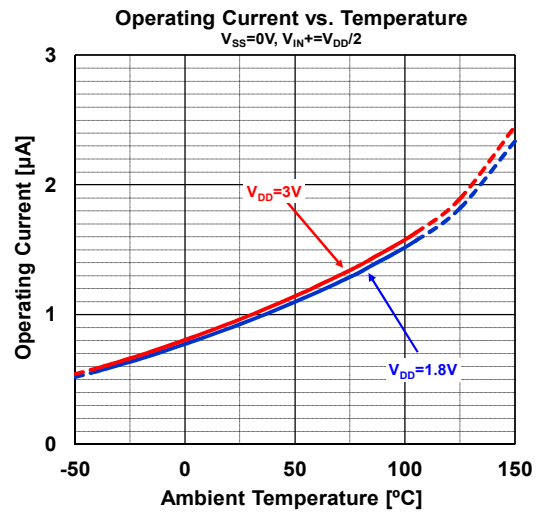
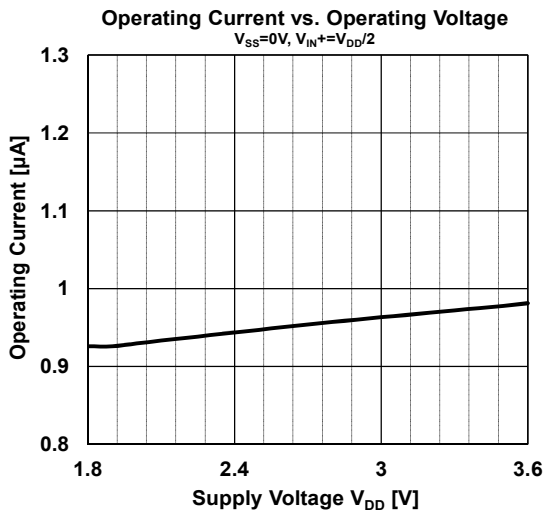

## ■ TYPICAL CHARACTERISTICS

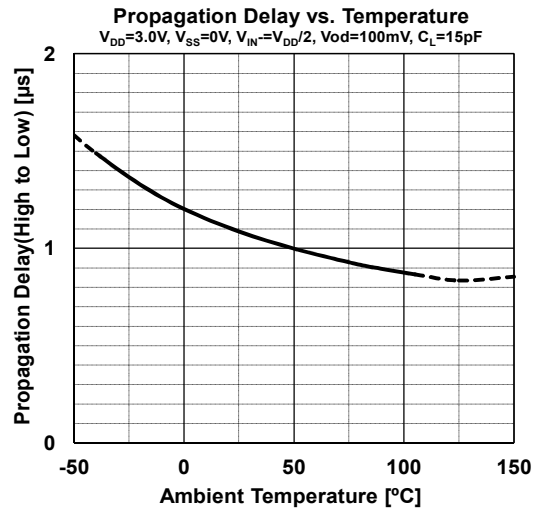
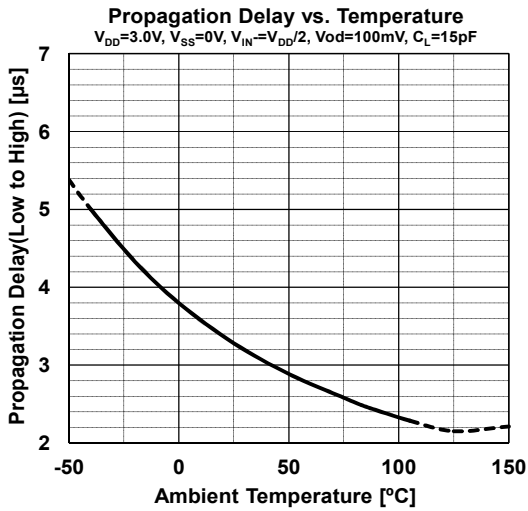
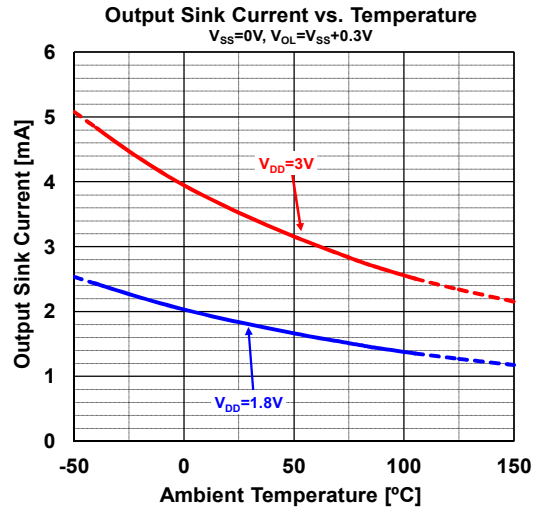
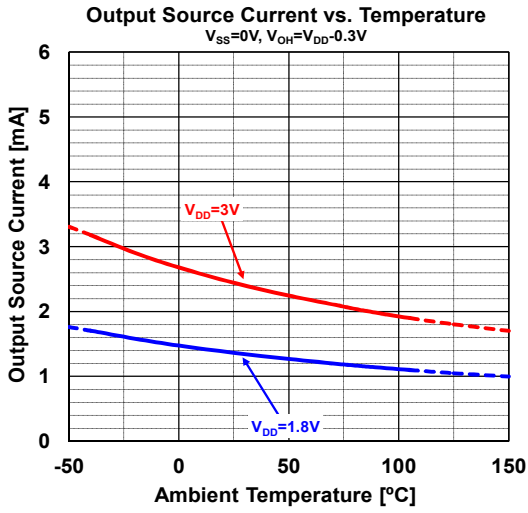

## ■ SWITCHING CHARACTERISTICS MEASUREMENT CIRCUIT

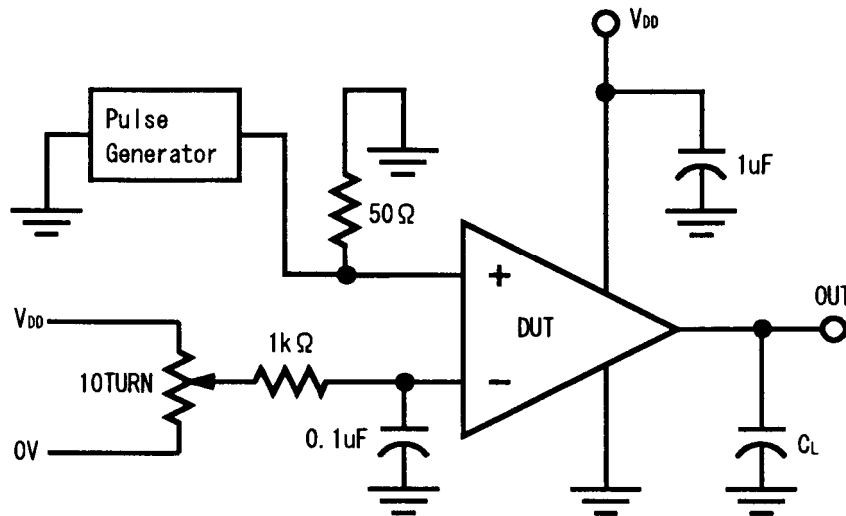

## ■ TIMING WAVEFORM

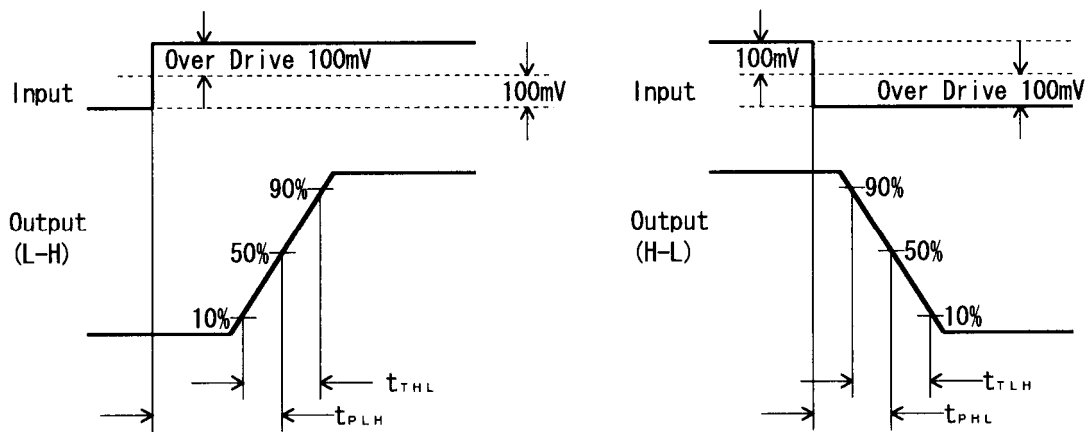

# NJU7116

## ■ PACKAGE DIMENSIONS

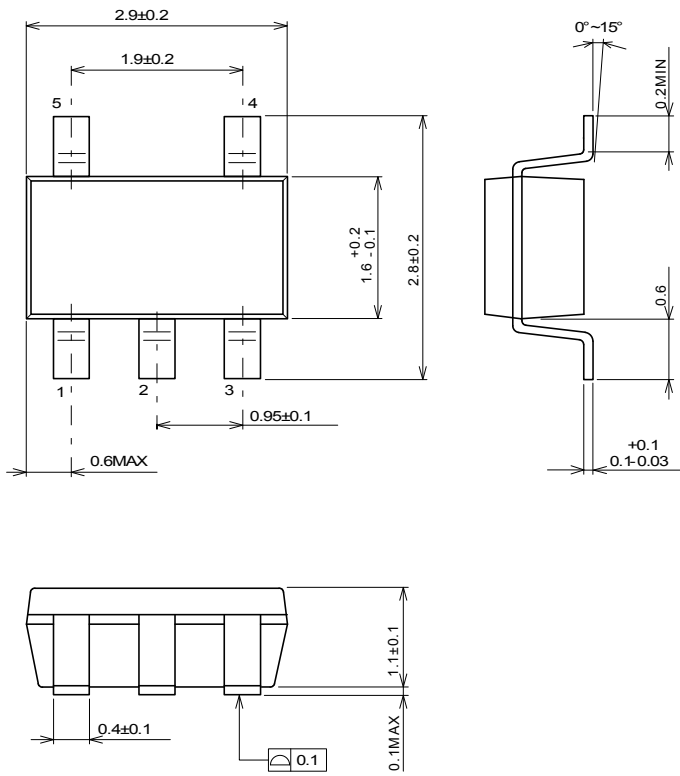

Unit: mm

SOT-23-5 Package

■ PACKAGE DIMENSIONS

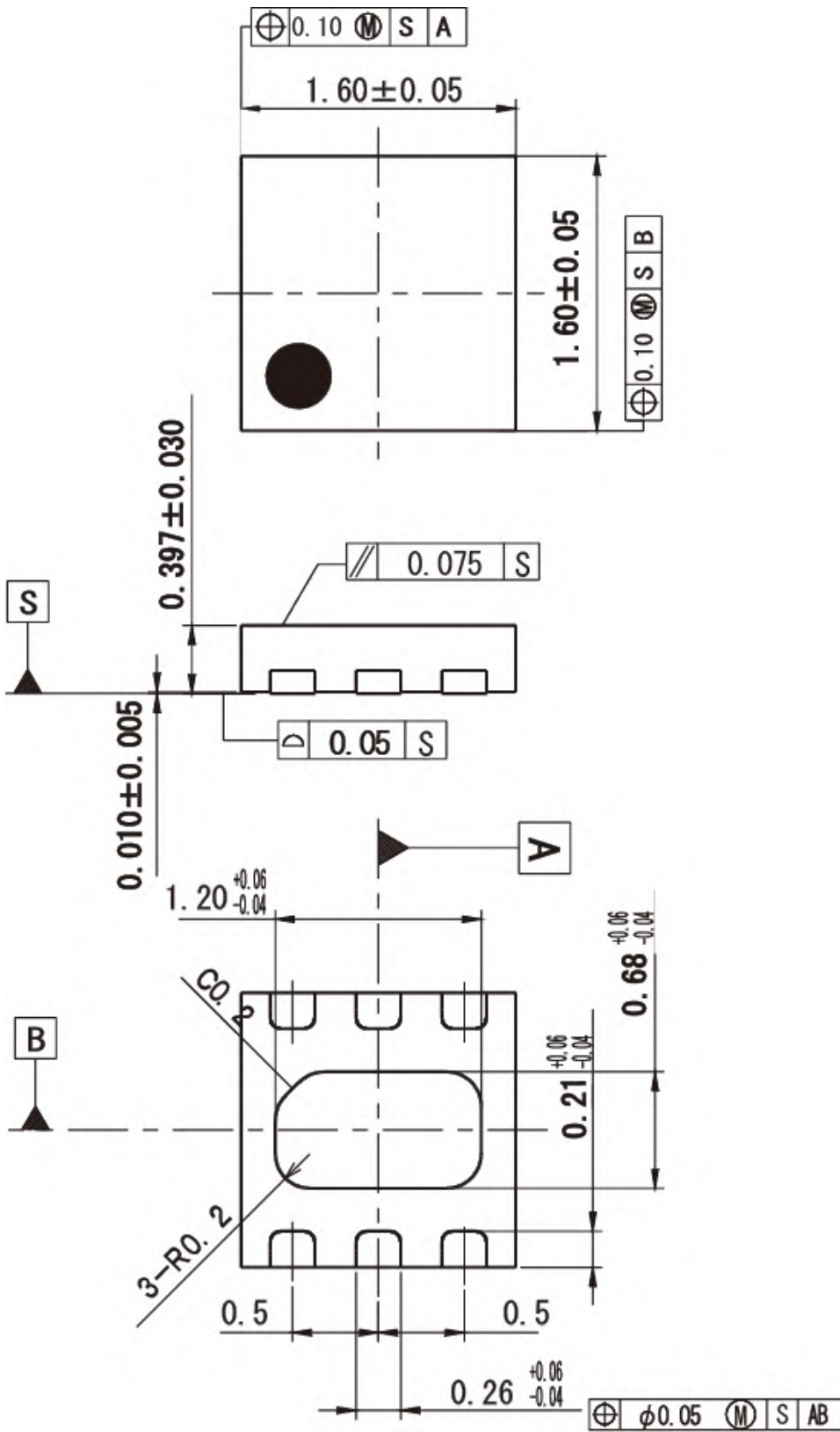

Unit: mm

DFN6-G1 Package

[CAUTION]  
 The specifications on this databook are only given for information, without any guarantee as regards either mistakes or omissions. The application circuits in this databook are described only to show representative usages of the product and not intended for the guarantee or permission of any right including the industrial rights.