

Product Summary

- 20V/-7 A
- $R_{DS(ON)} = 22m\Omega(Typ.)@V_{GS}=-4.5V$
- $R_{DS(ON)} = 26m\Omega(Typ.)@V_{GS}=-2.5V$

Application

- Battery Pack
- Portable Devices

Package and Pin Configuration

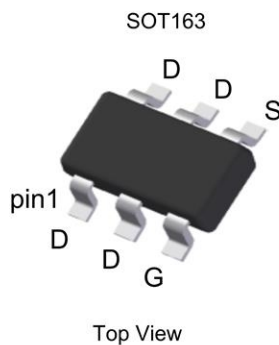

Circuit diagram

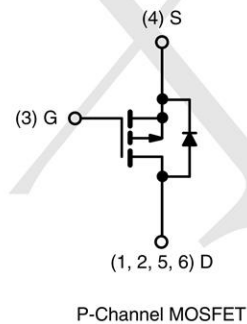

Marking:

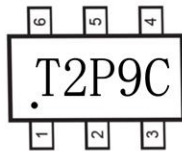

Absolute Maximum Ratings ($T_A=25^{\circ}C$ unless otherwise noted)

PARAMETER	SYMBOL	LIMIT	UNIT
Drain-Source Voltage	V_{DS}	-20	V
Gate-Source Voltage	V_{GS}	± 12	V
Continuous Drain Current	I_D	$T_C = 25^{\circ}C$	-7
		$T_C = 100^{\circ}C$	-4.9
Pulsed Drain Current ^(Note 1)	I_{DM}	-26	A
Total Power Dissipation	P_{DTOT}	1.56	W
Operating Junction Temperature	T_J	150	$^{\circ}C$
Operating Junction and Storage Temperature Range	T_J, T_{STG}	- 55 to +150	$^{\circ}C$

Thermal Characteristic

PARAMETER	SYMBOL	LIMIT	UNIT
Junction to Ambient Thermal Resistance	$R_{\theta JA}$	80	$^{\circ}C/W$

Electrical Characteristics ($T_A=25^\circ\text{C}$ unless otherwise noted)

PARAMETER	CONDITIONS	SYMBOL	MIN	TYP	MAX	UNIT
Static (Note 2)						
Drain-Source Breakdown Voltage	$V_{GS} = 0V, I_D = -250\mu A$	BV_{DSS}	-20	--	--	V
Gate Threshold Voltage	$V_{DS} = V_{GS}, I_D = -250\mu A$	$V_{GS(TH)}$	-0.4	--	-1.1	V
Gate Body Leakage	$V_{GS} = \pm 12V, V_{DS} = 0V$	I_{GSS}	--	--	± 100	nA
Zero Gate Voltage Drain Current	$V_{DS} = -20V, V_{GS} = 0V$	I_{DSS}	--	--	-1	μA
	$V_{DS} = -16V, T_J = 125^\circ\text{C}$		--	--	-10	
Drain-Source On-State Resistance	$V_{GS} = -4.5V, I_D = -5A$	$R_{DS(on)}$	--	22	26	m Ω
	$V_{GS} = -2.5V, I_D = -4A$		--	26	32	
	$V_{GS} = -1.8V, I_D = -3A$		--	32	40	
Forward Transconductance	$V_{DS} = -10V, I_S = -5A$	g_{fs}	--	15	--	S
Dynamic (Note 3)						
Total Gate Charge	$V_{DS} = -10V, I_D = -5A,$ $V_{GS} = -4.5V$	Q_g	--	19.5	--	nC
Gate-Source Charge		Q_{gs}	--	2	--	
Gate-Drain Charge		Q_{gd}	--	3.6	--	
Input Capacitance	$V_{DS} = -15V, V_{GS} = 0V,$ $F = 1.0\text{MHz}$	C_{iss}	--	1670	--	pF
Output Capacitance		C_{oss}	--	220	--	
Reverse Transfer Capacitance		C_{rss}	--	120	--	
Switching						
Turn-On Delay Time	$V_{DD} = -10V, I_D = -1A,$ $V_{GS} = -4.5V,$ $R_{GEN} = 25\Omega$	$t_{d(on)}$	--	10.4	--	ns
Turn-On Rise Time		t_r	--	37.5	--	
Turn-Off Delay Time		$t_{d(off)}$	--	89.1	--	
Turn-Off Fall Time		t_f	--	24.6	--	
Source-Drain Diode						
Forward Voltage	$V_{GS} = 0V, I_S = -1A$	V_{SD}	--	--	-1	V
Continuous Forward Current	Integral reverse diode in the MOSFET	I_S	--	--	-7	A
Pulse Forward Current		I_{SM}	--	--	-26	A

Typical Electrical and Thermal Characteristics

Continuous Drain Current vs. T_c

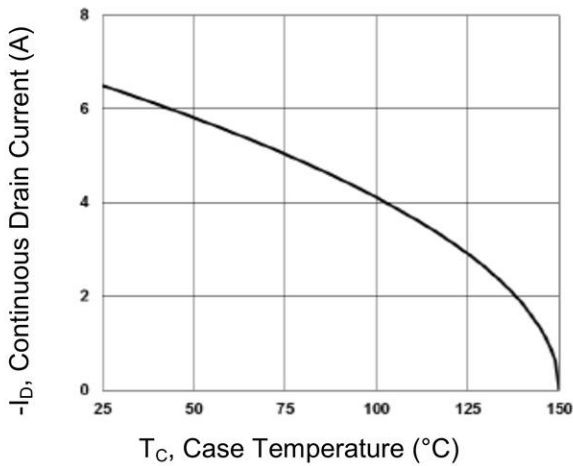

Gate Charge

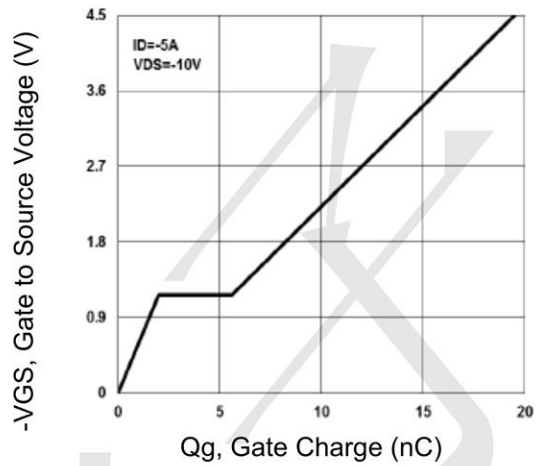

On-Resistance vs. Junction Temperature

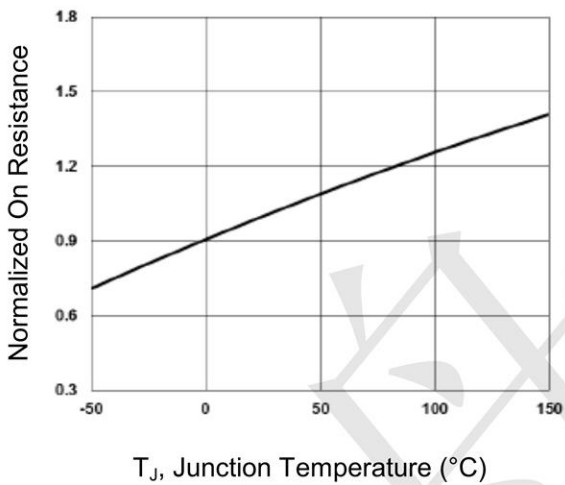

Threshold Voltage vs. Junction Temperature

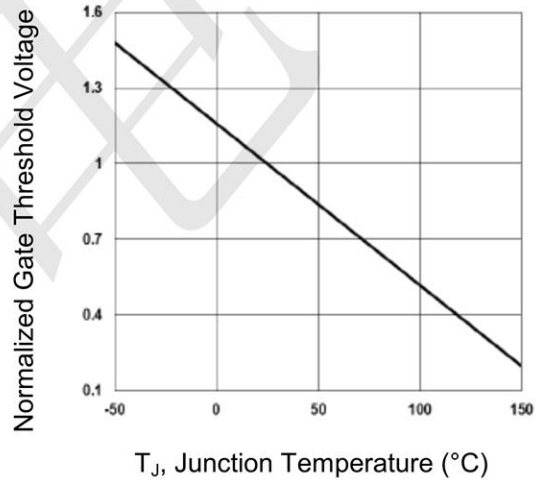

Maximum Safe Operating Area

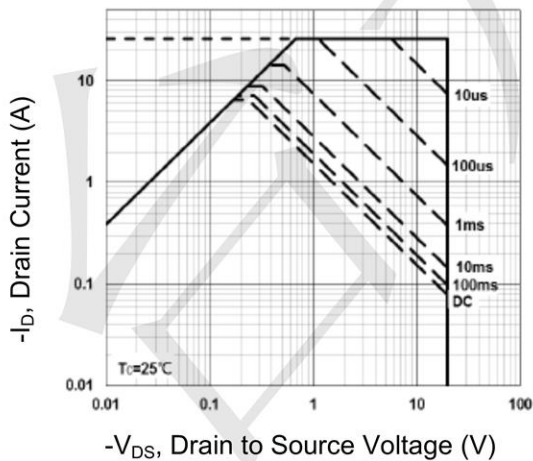

Normalized Thermal Transient Impedance Curve

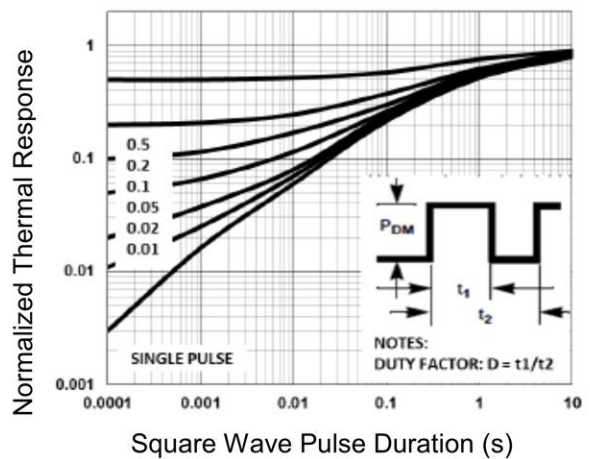

SOT163 Package Outline Dimensions

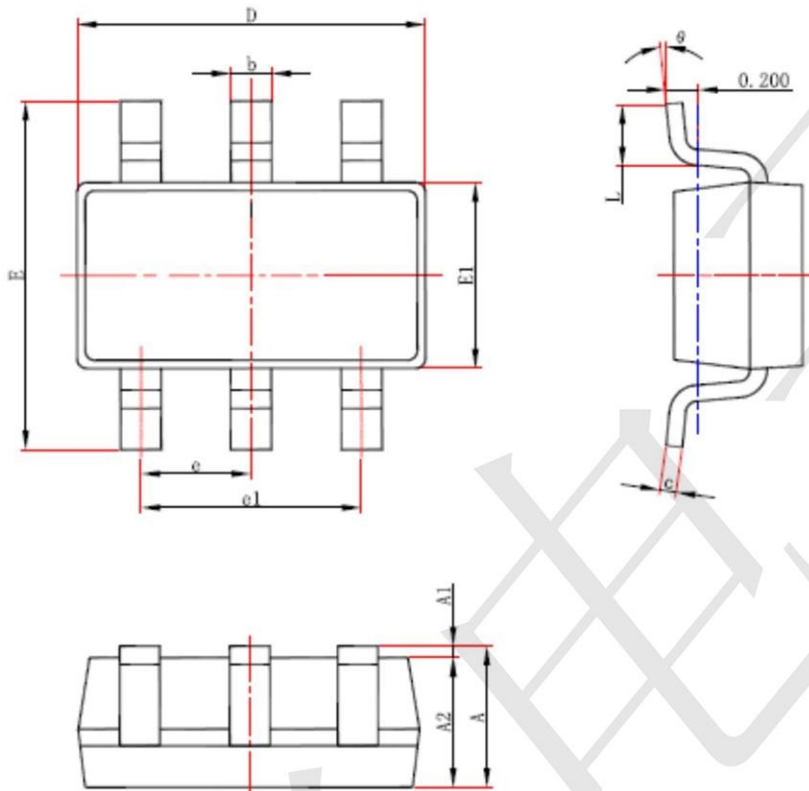

Symbol	Dimensions In Millimeters		Dimensions In Inches	
	Min.	Max.	Min.	Max.
A	1.050	1.250	0.041	0.049
A1	0.000	0.100	0.000	0.004
A2	1.050	1.150	0.041	0.045
b	0.300	0.500	0.012	0.020
c	0.100	0.200	0.004	0.008
D	2.820	3.020	0.111	0.119
E1	1.500	1.700	0.059	0.067
E	2.650	2.950	0.104	0.116
e	0.950(BSC)		0.037(BSC)	
e1	1.800	2.000	0.071	0.079
L	0.300	0.600	0.012	0.024
θ	0°	8°	0°	8°